

2012 BMW
1 Series Coupe

128i
135i



The Ultimate
Driving Machine®



THE NEW BMW 1 SERIES COUPE.

MAKE THE CITY'S HEART BEAT FASTER.

BMW EfficientDynamics
Less emissions. More driving pleasure.

FROM REVOLUTIONARY BEGINNINGS, RIGHT TO YOUR DRIVEWAY.

Once upon a time, BMW had to prove ourselves to America. We introduced a vehicle that would deliver a driving experience that was not only uniquely exhilarating, but revolutionary: the 2002ti. Today, the 2012 BMW 1 Series Coupe brings back that same formula, but updated for modern times – and modern drivers. Instantly identifiable while full of surprises, the 1 Series Coupe puts the thrills of the road back in the hands of those behind the wheel, with a host of innovative driving technologies and conveniences. Yet for all its advances, at heart the 1 Series Coupe is a pure, simple and supremely satisfying vehicle that perfectly captures the best of BMW.





The BMW 1 Series Coupe

COMPACT DESIGN. LIMITLESS FUN.

- 06 Highlights**
Updated and ready to drive.
- 08 Exterior**
Coupe contours, BMW attitude.
- 10 Performance**
Inspiring performance.
- 12 The BMW 135i Coupe**
Sets the pace.
- 14 BMW ConnectedDrive**
Stay connected.
- 16 Lighting design**
Brilliant from front to back.
- 18 BMW EfficientDynamics**
Always thinking ahead.
- 20 The winds of change**
The BMW 128i Coupe with the Air Curtain.
- 22 Interior**
Luxury, comfort and space.
- 26 A firmly held belief in comfort**
Sport seats that take seating to the next level.

Technology

INNOVATION MEETS INSPIRATION.

- 30 BMW EfficientDynamics**
Technology that reduces fuel consumption and enhances performance.
- 32 Engines**
Maximum horsepower and torque from minimum fuel consumption.
- 34 Chassis and safety**
Responsive handling and safety innovations.
- 38 BMW ConnectedDrive**
Intelligent network for better convenience, infotainment and safety.
- 42 A test drive on the Nürburgring**
The BMW 1 Series Coupe gets the ultimate workout.

bmwusa.com/new1coupe

Equipment

AS INDIVIDUAL AS YOU ARE.

- 44 Combination examples**
- 46 Exterior colors**
- 47 Upholstery colors**
- 48 Interior trims**
- 49 Recommended color combinations**
- 50 Standard/Optional equipment**
- 58 M Sport Package**
- 59 Original BMW Accessories**
Multifaceted and individual. Exclusively you.

bmwusa.com/byo

Overview

THE VERSATILE BMW 1 SERIES COUPE.

- 60 Equipment charts**
- 64 Technical data**
- 66 BMW Services**
Exclusive offers for BMW customers.

bmwusa.com



Want the inside scoop on BMW?
You can find us on Facebook® at
[facebook.com/bmwusa](https://www.facebook.com/bmwusa).

Editorial

LOOKING FORWARD TO DRIVING THRILLS.

There is free-spirited adventure – this is the exhilaration of the unknown. Then there is calculated performance – a combination of extensive research, time-tested principles and applied technology. Somewhere in between, you'll find the BMW 1 Series Coupe: the distillation of emotion and engineering in one exceptional vehicle.

Redesigned for 2012, the 1 Series Coupe debuts innovative new features. Two noteworthy introductions: the Air Curtain that enhances the aerodynamics of the 128i; and the distinctive white interior trim option that sets off the upholstery colors and vibrant exterior paints.

As with all BMWs, the 1 Series Coupe's development is based on EfficientDynamics technology. This accounts for everything from the suspension's lightweight construction to the engine's efficient performance. It's driving pleasure with environmental responsibility.

It's not a reinvention; it's not a reinterpretation. It's what BMW has always been: a blend of the classic with the advancements of today. Get behind the wheel of the 1 Series Coupe and discover how the high spirits of this BMW's agile handling and thrilling power compel you to unlock the pleasure of every mile.

bmwusa.com/new1coupe

BMW 135i Coupe shown with the following equipment:

| | |
|---------------------|---|
| Engine: | 24-valve BMW TwinPower Turbo 3.0-liter inline six-cylinder engine |
| Nominal output: | 300 hp @ 5800 rpm |
| Wheels: | Double Spoke (Style 261M) light alloy |
| Exterior color: | Alpine White |
| Upholstery: | Black Boston Leather |
| Interior trim: | Alpine White |
| Optional equipment: | M Sport Package, Park Distance Control (PDC) |

For details on specifications, please refer to pages 64-65.

**SPORTY, RESPONSIVE, DESIRABLE.
A TRUE BMW ORIGINAL. AGAIN.**

Rediscover the 2012 BMW 1 Series Coupe.





THE 1 SERIES COUPE: IMPROVING ON GREAT.

It starts with a winning foundation.

Hailed as a popular and critical favorite upon its U.S. debut, the 1 Series perfectly captured the spirit of BMW with a simple yet powerful formula. When creating the 2012 1 Series Coupe, it was only natural that BMW designers and engineers would retain what made the original a success: its compact design, extensive use of lightweight components and additive power of high-performance six-cylinder engines. From there, BMW added new features inside and out. For example, new light clusters front and rear include L-shape LED taillights that, like the illuminated “eyebrows” of the front light assembly, add a distinctive and highly visible accent. Inside, new switches, controls and trim lend even more elegance and convenience to the comfortable cabin. Discover how a vehicle that already makes all the right moves can be transformed into something even better: the 1 Series Coupe.

For details on the availability of standard and optional features, please refer to the Equipment charts section at the back of this brochure.



EFFICIENT PERFORMANCE BUILDS GREATER MOMENTUM.

Delivering horsepower, torque – and driving thrills.

For every smile on the faces of 1 Series Coupe drivers, there are two possible culprits. As far as pure driving pleasure is concerned, the 1 Series is perfectly matched to either of its two engine options.

Take the 128i and its aluminum/magnesium powerplant. This advanced 3.0-liter inline six-cylinder generates an impressive 230 horsepower and 200 lb-ft of torque, using BMW's throttleless Valvetronic technology for quicker, cleaner performance and efficiency. Equipped with the smooth-shifting, standard 6-speed manual transmission, the 128i goes from 0-60 in 6.1 seconds.¹

Seeking even more lean BMW muscle under the hood? Try the 135i. Equipped with BMW's award-winning 3.0-liter, six-cylinder TwinPower Turbo engine, it develops a thundering 300 horsepower and 300 lb-ft of torque.

This dynamo delivers more than just satisfying performance. BMW's High Precision Direct Injection provides optimum efficiency while maximum torque is delivered between 1300 and 5000 rpm. This innovative technology results in a thrilling payoff: a brisk, breathtaking 0-60 sprint in just 5.1 seconds with the 6-speed manual transmission.²

Want even higher performance? Equip your 135i with the 7-speed Double Clutch Transmission (DCT), and shift your driving experience into the realm of the track-inspired. This groundbreaking transmission propels the 135i from 0-60 in a scorching 5.0 seconds² – fast enough to please even the most discerning driver.

When it comes to performance, the 1 Series pushes the limits like no other vehicle in its class.

¹ BMW AG test results; 6.7 seconds with STEPTRONIC automatic transmission. BMW urges you to obey all posted speed laws and always wear safety belts.

² BMW AG test results. BMW urges you to obey all posted speed laws and always wear safety belts.

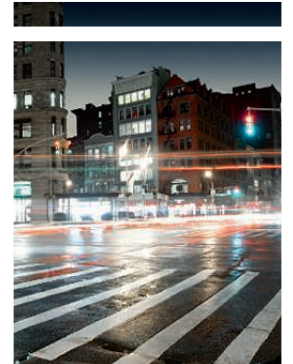

NO OTHER COUPE CAN TRULY KEEP UP.

The 2012 BMW 135i Coupe.

The 1 Series is a perfect iteration of the BMW spirit – and the 2012 135i Coupe is the purest, sportiest version of the 1 Series yet. This compact yet powerful two-door makes all the right moves to keep even the most discerning drivers happy. Look beyond the formidable 300-hp TwinPower Turbo six-cylinder engine and optional 7-speed Double Clutch Transmission: the 135i incorporates several impressive upgrades that uphold its high-performance heritage. Most notably, the standard Aerodynamic kit offers meticulously engineered front and rear aprons as well as dynamic side skirts, all designed to improve airflow around the vehicle. Details like these set the 135i Coupe apart from its competitors – by several car lengths.

For details on the availability of standard and optional features, please refer to the Equipment charts section at the back of this brochure.



امداد درو فارما

تلفن شبانه روزی: ۰۲۱-۸۵۰۰۰۰۰۰

www.ammad.com

BMW ConnectedDrive
In touch with your world.

CLASSIC DRIVING THRILLS MEET THE 21ST CENTURY.

Get hooked up with BMW ConnectedDrive.

While its handling echoes BMW's high-performance heritage, the 1 Series Coupe is strictly future-driven. Today, drivers and passengers require advanced communication capabilities. ConnectedDrive lets you stay in touch with your life and your music, all with your safety and comfort in mind. Looking for the location of that hot, new restaurant? A quick Google® search – done on your iDrive Display screen – not only finds the address, but sends it to your Navigation system to direct you there. Want to check your text messages? A Text-to-speech feature reads them aloud, allowing you to keep your eyes on the road. Need to return a missed call? Advanced Bluetooth® connectivity, along with enhanced iDrive functionality, makes it easy to do so from your BMW; you can even use your Display screen to view your phonebook info at a glance.

Another benefit of Bluetooth connectivity: the ability to stream music wirelessly from your media player or mobile device right through your BMW's speaker system. Connect your iPhone® or iPod® via USB and you can even see the album cover art on the Display screen. Use your iDrive Controller to quickly and intuitively browse, select and enjoy. It's all at your fingertips.

For details on the availability of standard and optional features, please refer to the Equipment charts section at the back of this brochure.

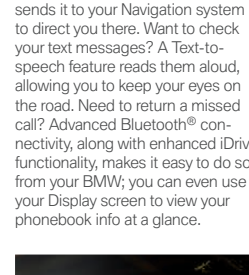



BRILLIANT, FROM FRONT TO BACK.

No detail is taken too lightly.

Proof that no element goes unnoticed by our designers: the personality of the 2012 1 Series Coupe is immediately evident even in the new light assemblies at the front and rear. A more "concentrated" look is the first thing you'll notice when facing the vehicle head-on. The unique "eyebrow" design is bolstered by the Xenon Adaptive Headlights with LED accents that confidently pierce the night air. Corona headlight-rings add another BMW signature element. In the rear, newly designed L-shape taillights lend a sportier look, especially when complemented by brilliant LED lighting. The 1 Series Coupe even adds active safety into this illuminating equation: the Xenon Adaptive Headlights come equipped with integrated Cornering Lights that swivel to cast light on every turn, while Adaptive Brakelights illuminate even more brightly when greater stopping force is used.

For details on the availability of standard and optional features, please refer to the **Equipment charts** section at the back of this brochure.



MAXIMUM OUTPUT, MINIMUM WASTE – WHO KNEW IT COULD BE SO EXCITING?

BMW EfficientDynamics.
Sustainability in motion.

When it comes to automobiles, the designers and engineers at BMW have a different perspective than those at other manufacturers. This is because BMW's EfficientDynamics concept challenges them to maximize both performance and efficiency while decreasing emissions.

The most obvious examples start with the engine. Throttleless Valvetronic intake and Double-VANOS steplessly variable valve timing, for example, enhance clean, reliable power delivery. This not only improves output, it also saves valuable resources. Drivers get all the exhilaration they crave, with less cost and fewer emissions – a true win-win situation.

This output-maximizing thinking doesn't stop there. The same principle is applied to every aspect of the vehicle. For example, by lessening overall weight, the effect is the same – because a lighter car requires less fuel to move. So the double-pivot front suspension is crafted in lightweight aluminum; the five-link fully independent rear suspension is made of lightweight steel.

Aerodynamics also plays an important part in EfficientDynamics. The new, innovative Air Curtain in the 128i front fascia, for example, channels the air through two ducts in the front air dam, then diverts it around the front wheel arches. Though each duct is only four inches long and one inch wide, this improves airflow, reduces turbulence and increases efficiency.

For details on the availability of standard and optional features, please refer to the Equipment charts section at the back of this brochure.





THE WINDS OF CHANGE.

The Air Curtain, which reduces air resistance at the wheel arches of the 2012 BMW 128i, was developed in the turbulent roar of a new high-tech wind tunnel.

In the giant wind tunnel at the BMW Group's Aerodynamic Test Center in Munich, driving reality is turned inside out: it's the vehicle that stays still while its environment moves around it. A huge rotor that consumes 4.4 megawatts of power drives 25,550 cubic yards of air around an airflow ring. Before reaching the test track, the air is forced through a duct to accelerate its speed six times. Road conditions are simulated using five thin steel rolling tracks. The wheels of the test vehicle are driven by four narrow belts, while the long central belt under the car moves at exactly the same speed. This complex arrangement ensures that the airflow at the car's undercarriage, wheels and wheel arches is almost identical to that of a real driving situation. It's as if the very road itself were being put to the test.

When it comes to aerodynamics, a 10 percent reduction in air resistance leads to a good 2.5 percent reduction in fuel consumption.

Although the 1 Series Coupe body is already aerodynamically optimized, it accounts for only 40 percent of the vehicle's total air resistance. An additional ten percent is caused by the cooling air for the engine, transmission and brakes; 20 percent from the vehicle underbody; and the final 30 percent is produced at the wheels and the wheel arches. In all these areas, the 1 Series Coupe still had room for improvement.

This Aerodynamic Test Center testing has yielded an innovative solution: the new Air Curtain in the front air dam, which makes its debut in the 128i. This dynamic feature protects the front wheels from headwind and reduces turbulence over the front tires. Air is taken in through vents in the front air dam. As the vent ducts narrow, the air picks up speed. It exits at high speed through narrow slits, covering the outer face of the front wheels like a curtain. This Air Curtain acts like an invisible wheel cover: imperceptible yet highly effective.

Used in conjunction with the optimized cooling-air ducts and a smoothed-off undercarriage, the new Air Curtain provides the 128i with an excellent air-resistance coefficient, as well as reduced uplift. The result: improved fuel efficiency – and increased vehicle stability.

To the rear of the test track, tall hemispherical partitions guide the airflow back in the opposite direction.

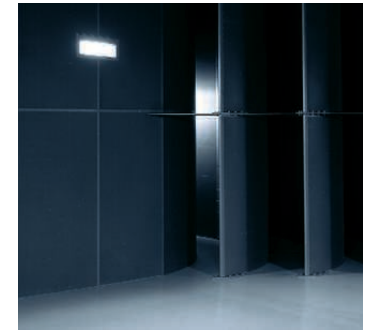

Left: Aerodynamics experiments in the giant testing bay are controlled from the wind tunnel's control room.

Right: The airflow over the BMW 1 Series Coupe is made visible by means of a smoke tracer. The slighter the turbulence created, the lower the air resistance.



EVERY INCH AN ATHLETE.

New detailing for a sportier look.

What does sportiness look like? That answer takes shape in the cockpit of the 1 Series Coupe. In honor of its high-performance heritage, BMW now offers a visually arresting Alpine White interior trim as a new option for 2012. This bright, athletic-looking trim complements the extensive use of galvanized pearl gloss throughout the cabin – from the iDrive Controller, rotary knobs, interior door handles and glovebox handle to the ornamental strips on the sport steering wheel. These highlights underscore the 1 Series Coupe's personality: expressively elegant mixed with high-performance fun.

For details on the availability of standard and optional features, please refer to the Equipment charts section at the back of this brochure.





THE PERFECT SETTING FOR EXPERIENCING DRIVING PLEASURE.

Luxury and comfort in harmony.

From any vantage point, the 1 Series Coupe's interior caters to your every whim. The two front seats offer myriad convenience features all within easy reach. Opt for the heated steering wheel for absolute comfort in cold-weather driving. Automatic climate control with left/right temperature controls makes it easy to drive in comfort. Available Boston Leather upholstery, in choices like Savannah Beige/Black or Oyster, lend a luxurious personality to the roomy interior. To complement this elegance, trim options range from exclusive Alpine White to Gray Poplar Wood, Light Burl Walnut Wood, Glacier Silver Aluminum trim – even a sporty High-Gloss Black Trim. Despite its compact size, the 2012 1 Series Coupe is every inch a BMW.

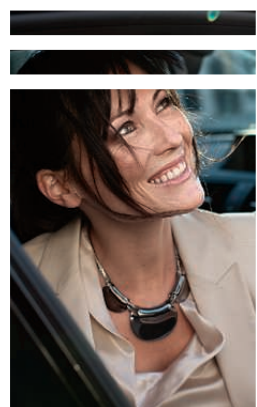

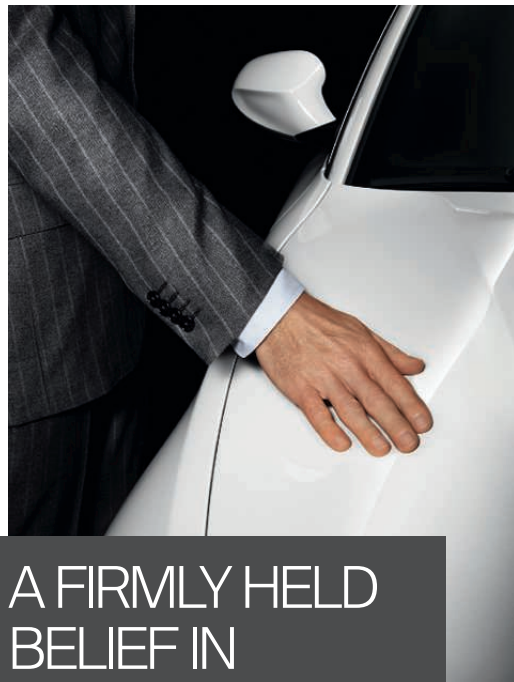

A FIRMLY HELD BELIEF IN COMFORT.

BMW seats are regarded as the gold standard of safety and sportiness. Even at high speeds, sport seats let drivers enjoy complete control and outstanding comfort.



امداد خودرو و با

۰۲۱-۸۸۶۲۰۸۵

Farmasoft.com

Driving requires total concentration – and a steady, secure seating position that allows you to interact intuitively with your vehicle’s controls at all times; from the steering wheel to the Navigation system to the brake pedal. No surprise, then, that the comfort and support of the 1 Series Coupe’s seats are an important part of the driving experience. In fact, BMW seats are regarded by experts as a gold standard in terms of comfort, safety features and sportiness.

When designing seats, equal importance is given to passive safety features, including side airbags that are stowed in the seatbacks and by their headrests. Yet BMW seats are designed to accommodate occupants of all sizes, with extensive levels of adjustment. For even greater front-seat comfort, the eight-way power front sport seats included in the M Sport Package offer adjustable side bolsters, two-way manual headrests and manual thigh support. Customizable lumbar support provides an additional level of adjustment, bolstering the pelvis and holding the spine in its natural “S” shape.

Despite setting the standards in seating ergonomics, BMW has already begun work on the next generation of sport seats. The goal, as in many BMW projects, is to make seats that are lighter and less bulky. This can be achieved through the use of innovative



structures from the field of bionics, as well as newly developed lightweight materials. Of course, these seats will also require the intelligent integration of both manual and

power controls. In fact, the minimalist seat “shells” in the BMW Vision EfficientDynamics Concept vehicle offer a glimpse into the future of sporty yet functional seats.

Sport seats provide a seating position that makes it easy to drive long distances while remaining completely at ease. Adjustable side supports bolster the torso, so you can steer with precision even around tight turns.



امداد خودرو فارس

تلفن شماره روزی: ۰۸۵-۱۱۸۶۲۰۲

FarmaSOS.com

Barely visible at ground level of the front air dam, the Air Curtain on the 2012 BMW 128i Coupe streams air through narrow vents. This air is then accelerated and forced out at even higher speed across the front wheels, where it creates an "air curtain." Although it seems a small, simple detail, this innovation reduces air resistance – which, in turn, leads to an improvement in stability and a reduction in fuel consumption. It's a great example of how even unassuming BMW components can have a larger effect.

BMW EfficientDynamics

Less emissions. More driving pleasure.

As a part of our sustainability strategy, BMW was one of the first manufacturers to pursue the goal of efficient driving technologies. BMW EfficientDynamics represents the most comprehensive package of innovative technologies for reducing fuel consumption and emissions – while simultaneously increasing driving dynamics – currently in standard production. To date, BMW has rolled out more than two million vehicles worldwide equipped with EfficientDynamics technologies. As a result, BMW has been able to reduce the CO₂ emissions of its fleet by approximately 30 percent since 1995.



Vision becomes reality: BMW Vision EfficientDynamics.

In 2014, BMW plans to introduce a 2+2 sports car that will feature groundbreaking plug-in hybrid technology with compact-class consumption, yet still retain sports-car performance. The BMW Vision EfficientDynamics test model has a latest-generation full-hybrid system with an output of 328 hp. A three-cylinder turbo diesel engine, as well as a hybrid synchronous engine on the front axle, and full-hybrid drive system on the rear axle, give the vehicle an impressive range. This innovative vehicle's performance-to-fuel-consumption ratio is, quite simply, without equal.

bmwusa.com/EfficientDynamics



BMW EFFICIENT DYNAMICS: WE PUT EVERYTHING INTO GETTING THE MOST OUT OF OUR VEHICLES.

At BMW, we create dynamic vehicles that thrill you with quick acceleration, predictable handling and reassuring control. We are also busy finding innovative fuels and technologies that help preserve the environment while delivering legendary performance. This is what we refer to as EfficientDynamics. This goal led to the visionary CleanEnergy hydrogen-powered engine in the BMW Hydrogen 7 Sedan. In 2009, BMW introduced Advanced Diesel with BluePerformance in the U.S., offering diesel with reliable power, increased fuel efficiency and reduced emissions. A year later, BMW's ActiveHybrid X6 and ActiveHybrid 7 vehicles combined combustion and electric power to boost performance while simultaneously reducing fuel consumption and CO₂ emissions. And now, a completely new vehicle concept is targeted to meet the need for sustainable mobility in fast-growing metropolitan areas, in the shape of the BMW i3.

BMW EFFICIENT DYNAMICS TECHNOLOGIES AT A GLANCE:

Air Curtain. Narrow openings on the left and right of the front air dam of the 128i direct-inflowing air into two sealed channels. These run along the inside of the front to the wheel arches, where the air re-emerges and is steered at high speed through a narrow opening close to the external surface of the wheel. The escaping air streams down the sides of the front wheels, minimizing air turbulence around the wheels and wheel arches, thereby further reducing fuel consumption.

Double-VANOS. VANOS is BMW's valve timing system that can "steplessly" vary the points in the combustion cycle when valves open and close. Double-VANOS refers to the fact that it operates on both the intake and exhaust camshafts. Electronically controlled in response to engine speed, load and temperature, VANOS reduces emissions, and enhances low- to medium-speed torque, as well as fuel efficiency.

Valvetronic. BMW's Valvetronic valve control system improves engine response and refinement, while also helping to reduce fuel consumption. Instead of using a traditional throttle, the system helps the engine "breathe" better by providing fully variable lift adjustment of the inlet valves. The result: improved cold starts, smoother running, and a significant drop in fuel consumption.

Efficient transmissions. The 1 Series Coupe offers a choice of transmissions, each designed to maximize efficiency. In both models, a smooth-shifting 6-speed manual transmission is standard. In the 128i, a 6-speed STEPTRONIC automatic transmission is also offered; the 7-speed Double Clutch Transmission (DCT) is available for the 135i.

Lightweight construction. Our engineers use lightweight aluminum throughout our vehicles – in the front section, for example, or for the suspension. BMW's six-cylinder TwinPower Turbo engine is all aluminum; the naturally aspirated inline six is an aluminum/magnesium composite – the lightest in its class. Taken together, these weight savings lead to lower fuel consumption and better axle load distribution for more agility, especially in curves.

BMW TwinPower Turbo Technology. The 300-hp 135i benefits from BMW's TwinPower Turbo engine with Valvetronic technology that delivers quick acceleration with virtually no "turbo lag." Fuel economy is impressive, as well, thanks to High Precision Direct Injection that ensures lean-burn operation under partial loads by providing optimum combustion of fuel.

THE HEART OF THE 2012 1 SERIES COUPE. TIMES TWO.

As remarkable as it may seem, both of the 1 Series Coupe engine options are perfectly suited to the vehicle; which model you choose is only a matter of personal preference. The 128i offers exhilarating horsepower and torque, in combination with compelling fuel efficiency. The 135i delivers even more power under the hood via BMW's TwinPower Turbo technology, while maintaining excellent fuel economy. Whichever way you go, the 1 Series Coupe turns every drive into pure enjoyment.

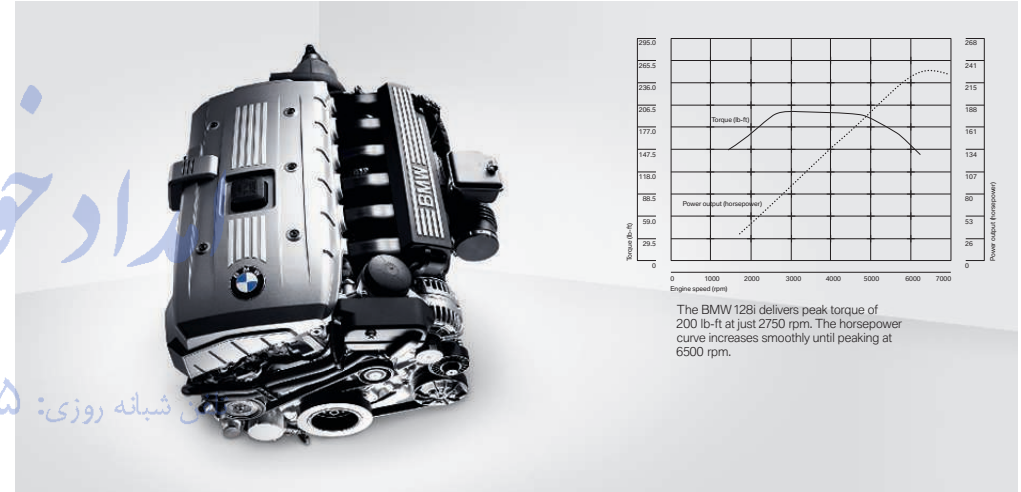
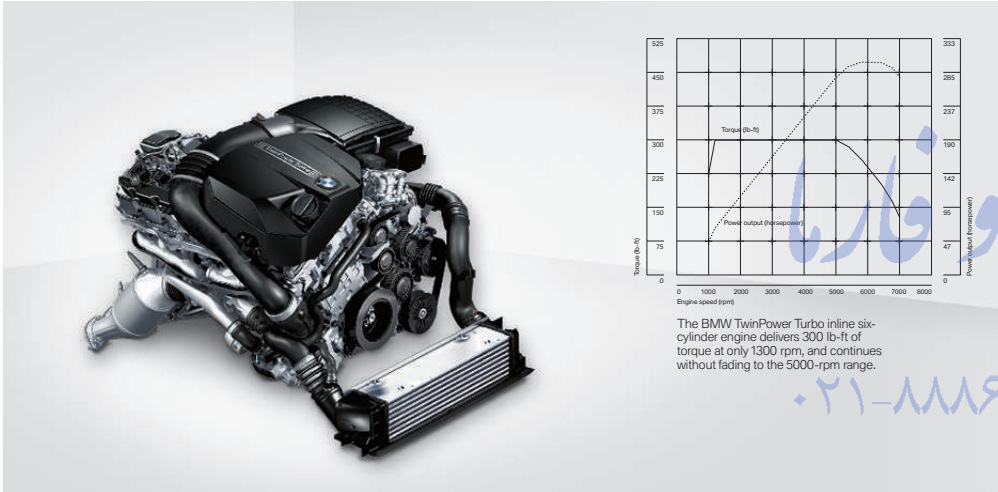

BMW 135i.
An outstanding example of the progress made in turbo technology, this award-winning 3.0-liter BMW TwinPower Turbo six-cylinder engine is the first in its class to combine a single twin-scroll turbocharger with direct fuel injection and Valvetronic fully variable valve control. These technologies imbue the 135i with a pinpoint-accurate power delivery system for impressive fuel efficiency. Such advancements also have a significant reward for the driver: a pavement-punishing 300 hp and 300 lb-ft of torque, with a thrilling 0-60 time of 5.0 seconds when equipped with BMW's innovative 7-speed Double Clutch Transmission.¹

BMW 128i.
The naturally aspirated inline six-cylinder engine in the 128i offers an impressive 230 hp and 200 lb-ft of torque, along with BMW's latest efficiency technologies like Double-VANOS and Valvetronic variable valve control. Hit the accelerator and experience a brisk 0-60 time of just 6.1 seconds when used in conjunction with BMW's smooth-shifting 6-speed manual transmission.² Whether you choose manual or STEPTRONIC automatic transmissions, you'll enjoy 28 mpg on the highway,³ extending the driving fun before having to stop to refuel.

FarmaSO

شبهه روزی: ۰۸۵۰۸۸۶۲۰۲۱

¹ BMW AG test results; 5.1 seconds with 6-speed manual transmission. BMW urges you to obey all posted speed laws and always wear safety belts.

² BMW AG test results; 6.7 seconds with 6-speed STEPTRONIC automatic transmission. BMW urges you to obey all posted speed laws and always wear safety belts.

³ 18 mpg city. EPA-estimated figures are for comparison purposes only. Your actual mileage will vary, depending on speed, driving habits, trip length and driving conditions; actual mileage may be lower.



“IN THE 1 SERIES COUPE, I’M CONNECTED TO EVERY INCH OF THE ROAD.”

Tackle the most challenging roads without compromising on control: the BMW 1 Series Coupe makes this possible with innovative suspension technologies. Our engineers construct the most advanced suspensions in order to handle every challenge faced on the pavement, from highways to back roads.



FROM THE GROUND UP, AN EXCEPTIONAL SUSPENSION.

From near-perfect 50/50 weight distribution, to the sporty and responsive handling of the vehicle at highway speeds, the 2012 1 Series Coupe is built on a foundation as revolutionary as the rest of the vehicle. After all, your closest link to the exhilaration of driving a BMW is at ground level. Read on to find out more.



Lightweight suspension. In the 1 Series Coupe, the rigid yet lightweight suspension is the perfect counterpart to the engine. How the car reacts to the road – as well as its superb handling of acoustics and vibrations – are a result of the advanced engineering behind this crucial link to the road. The aluminum double-pivot front suspension consists of a lightweight, twin-joint tension strut design for maximum strength with minimum weight; hydro-mounts reduce vibration and noise. Together with the five-link, fully independent rear suspension in lightweight steel and BMW’s signature rear-wheel drive, superbly sporty handling is par for any driving course.

Near 50/50 weight distribution. The front and rear axles each carry almost exactly half of the car’s weight. Balanced weight gives the 1 Series Coupe neutral steering and outstanding directional stability. With a sport-tuned suspension and standard Dynamic Stability Control, it remains stable in virtually all road conditions.

Active Steering. Further enhancing the quality of the driving experience, Active Steering is available in the 135i. This system adjusts both steering ratio and steering force in relation to driving speed. At low to medium speeds, a small turn of the steering wheel translates into a big turn of the front wheels. You enjoy more agility in city driving, quicker turns on twisting roads, and easier parking maneuvers. At higher speeds, a larger turn of the steering wheel is needed to turn the front wheels, resulting in greater straight-line stability.

7-speed Double Clutch Transmission (DCT). Available in the 135i, this transmission features two separate clutches for the odd and even gears. When one gear is disengaging, the next one is already engaged. You experience lightning-quick gear shifts with maximum precision, for acceleration without interruption of power. When you prefer hands-on control, both the racing-inspired steering wheel-mounted paddle shifters and the gear shift lever allow clutchless shifting.

For details on the availability of standard and optional features, please refer to the **Equipment charts** section at the back of this brochure.

IT TAKES UNIQUE TECHNOLOGY TO MAKE EVERY DRIVE AN EXCEPTIONAL PERFORMANCE.

Like the composition of a symphony, every component in the 1 Series Coupe works together in harmony to produce something totally unique and completely satisfying. Taken individually, these innovative features are no less impressive.

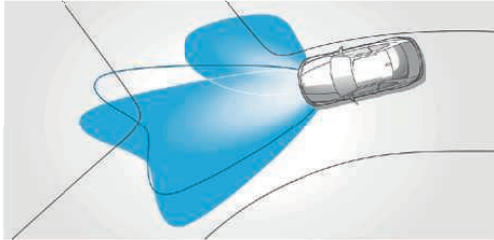

■/□ **Xenon Adaptive Headlights** automatically swivel to follow the curves of the road. The system uses data from on-board sensors and the steering wheel angle to determine the car's direction, then adjusts the headlights accordingly. The system offers outstanding nighttime vision.

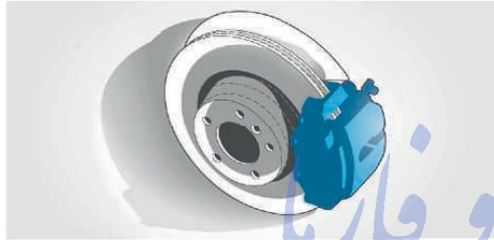

■ Massive, **high-performance anti-lock disc brakes** are ventilated at all four wheels for fade-resistant operation under hard use. Operated in conjunction with Dynamic Stability Control (DSC), brakes also benefit from Brake Drying, Brake Stand-by, Brake Fade Compensation and Start-off Assistant features. (Brake diameter sizes shown on page 65.)

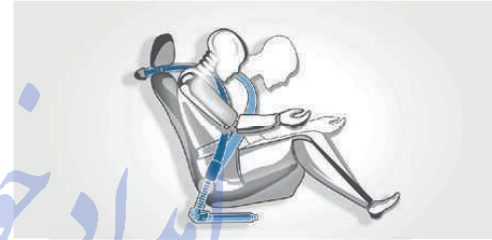

■ **BMW restraint system** for the driver and front passenger combines three-point safety belts, automatic safety-belt pretensioners, head restraints, and seat bolsters that help prevent occupants from sliding forward. Both rear seats include three-point safety belts and come standard with LATCH attachments for child seats. This system helps provide optimum restraint in a collision.

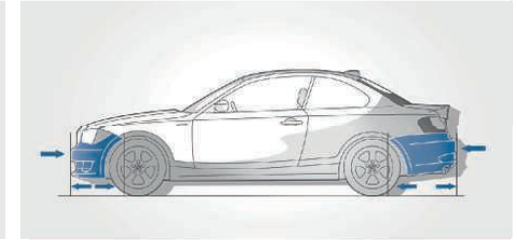

■ **Impact-absorbing bumpers** and compressible "crush tubes" front and rear help absorb the force of impact in collisions up to nine mph, minimizing damage to the vehicle's body and simplifying repairs. Only at higher impact speeds do structural supports begin to deform, dissipating impact energy to help protect occupants.

تلفن شبانه روزی: ۰۲۱-۸۸۸۶۲۰۸۵

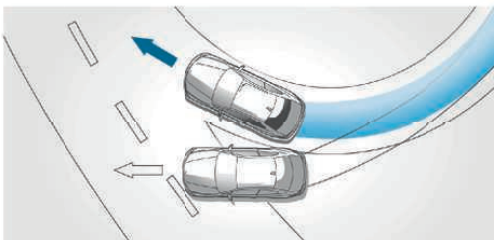

■ **Dynamic Stability Control (DSC)** helps stabilize the 1 Series Coupe in just milliseconds when it senses an impending skid. Whenever the system senses over- or understeer, it modulates engine power and can apply brakes individually to each wheel to help keep the vehicle under control and going in the intended direction. For sportier driving or in deep snow, **Dynamic Traction Control (DTC)** allows increased wheelslip.

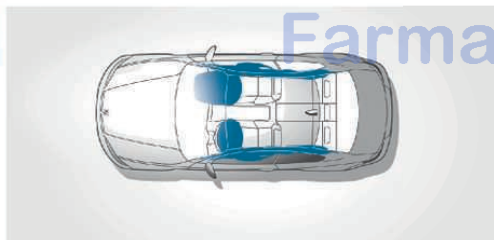

■ In a collision, BMW's **SRS (supplemental restraint system)** with advanced technology for the front airbags determines which airbags to deploy for optimal protection. The system also includes front-seat-mounted side-impact airbags and HPS (Head Protection System) to help protect passengers in both front and rear.

Please note: These pictures of airbags are for illustrative purposes only. Depending upon the type of accident, none, some or all airbags may deploy.

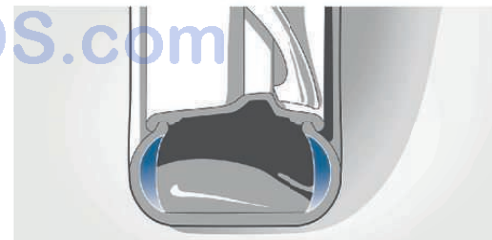

■ **Run-flat tires** allow speeds of up to 50 mph and travel from 30 to 150 miles after a loss of air pressure.¹ In situations that would normally result in a flat tire, reinforced sidewalls help prevent the tires from collapsing or loosening from the rim. In the event of a decline in tire pressure, the driver is warned by the **Tire Pressure Monitor**.

■ **Tire Pressure Monitor** is an electronic control system designed to warn the driver if there is a sudden and irregular loss of tire pressure. Should the target pressure of a tire fall below 25%, a warning light alerts the driver.

¹ Please see Owner's Manual for more information detailing allotted miles to travel and load weight rules for run-flat tires.

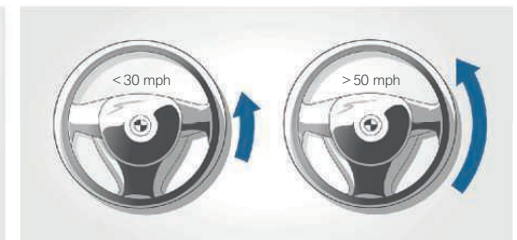

□ With **Active Steering**, at speeds up to 30 mph, a small turn of the steering wheel yields a greater turn of the front wheels for more direct response. When changing lanes at speeds over 50 mph, straight-line stability is enhanced because the front wheels require a greater turn of the steering wheel to effect a change of vehicle direction.



BMW ConnectedDrive In touch with your world.

The world has become one giant "network" in which we are all connected. BMW drivers need to stay in touch – so that they can search for information, communicate via telephone or email, and always be up-to-date while they're on the go. BMW's solution: BMW ConnectedDrive, a suite of technologies that delivers all the services and innovative technologies that link BMW vehicles and their passengers with the world outside. Now, being in your vehicle doesn't mean you have to take time out from your life.



BMW CONNECTED DRIVE: DRIVER, VEHICLE AND WORLD, INTELLIGENTLY NETWORKED.

Today's technology allows greater interactivity between vehicles, consumer electronics, the internet, and the driver. In a BMW, this is called ConnectedDrive. BMW ConnectedDrive offers innovations in the areas of convenience, safety and infotainment. Although these electronic systems will never replace the joy of driving, they do enhance the driving experience.

Take, for example, BMW's on-board Navigation system, which helps you plan your route, and also helps you avoid traffic jams by providing Real Time Traffic Information; its hard drive even has room to store your favorite music. Concerned about the weather you'll encounter on your trip? With BMW Online, you can access current weather conditions, as well as check the latest forecast. And to help you back into that tight parking space, utilize Park Distance Control and view your progress on the Display screen to make parking easier than it has ever been. No matter where you go, in a BMW, you're connected with the world.



BMW's on-board **Navigation system** uses Global Positioning System (GPS) satellites and data stored on an internal hard drive to guide you to your destination, which is displayed on a 16:9 high-resolution screen. Enhancements include 3-D daytime and nighttime maps, zoom, travel planner, and an Assistance Window. The system also offers Voice command for convenient, hands-free operation, and 12 GB of storage for your favorite media files. Online information services include MyInfo, which allows Google Maps™ destinations to be sent to your vehicle, as well as BMW Online when your vehicle is also equipped with BMW Assist™ Convenience Services.



BMW Online lets you know the latest weather forecasts, advisories and warnings, as well as news, stock indices and more, all shown on the Control Display inside your vehicle.

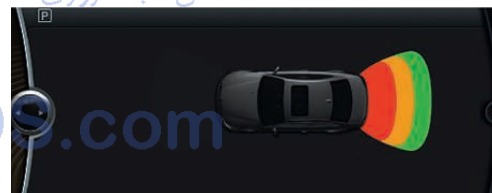

Park Distance Control (PDC) uses ultrasonic sensors in the rear bumper to help you judge the distance to other vehicles and unseen objects when parking. While engaged in a parking maneuver, acoustic signals and a visual indicator shown in the Control Display continually provide feedback on your progress. As the rear of your vehicle approaches a stationary object, the image shown on the Display screen changes and the warning beeps come faster as your bumper closes the distance to the object. To complement the distance visual display, the beeps turn into a constant tone when the distance is less than 12 inches. (Shown with BMW Navigation system.)

For details on the availability of standard and optional features, please refer to the **Equipment charts** section at the back of this brochure.

STAY TOTALLY IN TOUCH WHEREVER YOU GO – WITH BMW CONNECTED DRIVE.

Whether you're far from home or just in the next town, BMW Assist™ offers convenience and peace of mind. There are new ConnectedDrive features that extend BMW's leadership in wireless communications. Marvel at an extensive array of new Mobile Office functions. Get a visual image of your callers. With BMW Assist, you enjoy all this – and more.



BMW Assist gives you peace of mind knowing that a friendly response specialist is there to help you 24/7, at the touch of a button. The **Safety Plan** includes Automatic Collision Notification, Emergency Request (SOS), TeleService, Enhanced Roadside Assistance, Door Unlock, Stolen Vehicle Recovery, Customer Relations and MyInfo. The **Convenience Plan** adds personalized Directions, Traffic and Weather reports, BMW Online and Concierge services for restaurant and hotel recommendations, with the destination address and phone number sent to your BMW. Make up to four operator-assisted calls per year with Critical Calling if your mobile phone is not available or its battery is discharged.

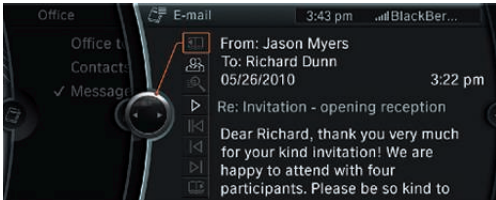

Use the time you spend in your vehicle even more effectively with BMW's **Mobile Office** feature. For example, when your vehicle is paired with a selected Bluetooth® interface, text messages and emails are transferred to your iDrive Display screen – and our system even reads them aloud to you. Thanks to Bluetooth audio streaming, you can enjoy wireless playback of your music files; your personal audio library can even be accessed via the iDrive Controller.

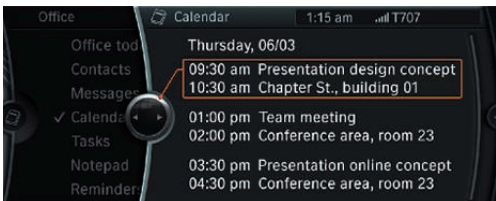

What's on today's agenda? Bring up the **Calendar** and **To-do List** on your Display screen while en route, to help you stay on schedule. Need to call your 11 o'clock appointment? Use the iDrive Controller knob to **click on the phone number** in the Calendar – and it's ringing. Meeting with several people? Conduct conference calls; the Display screen keeps you informed of the status of incoming calls. Who's calling you? If you've uploaded photos to your on-board phonebook, you'll see the caller's picture. Even missed calls are listed on the Display screen. It's never been easier to stay in touch while in transit.



Enhanced functions for the iPod® and USB adapter add to the ease and pleasure of using your iPod or iPhone®. Want to know which CD that song comes from? The album cover is shown on your Display screen. Don't purchase additional cables – your iPod or iPhone's original USB cable connects to your BMW's USB port. Another rare feature: with BMW Assist and Bluetooth audio streaming, you can wirelessly play music through the BMW audio system from any Bluetooth compatible music player or mobile phone, from anywhere in your vehicle. In fact, the audio library appears on the Display screen, where you can use the iDrive Controller knob to make your selection.



MyInfo allows you to send business locations and street addresses to your BMW from Google Maps™. Destinations and phone numbers can be accessed and exported to your Navigation system for immediate route guidance, while you can call the destination with your Bluetooth linked phone.



"Whenever I'm far from home, I have peace of mind knowing that BMW Assist is right there, ready to help me should I need it."

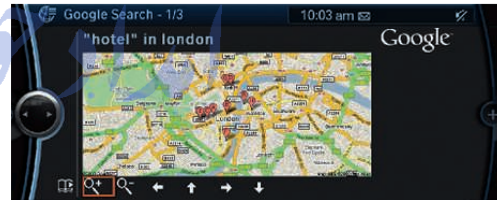

BMW Online allows online access to up-to-date fuel prices and gas station locations; the latest weather forecasts, advisories and warnings; Dow Jones, S&P 500 and NASDAQ indices; and the powerful reach of the Google Maps database – all delivered on the Control Display inside your vehicle. Access news headlines and have them read aloud via Text-to-speech technology. "Send to Mail" pinpoints your current location and planned destination, and allows you to send the information to any smartphone or email account. Then it's just a quick hyperlink to Google Maps for your friends and family to see where you are and where you're going.

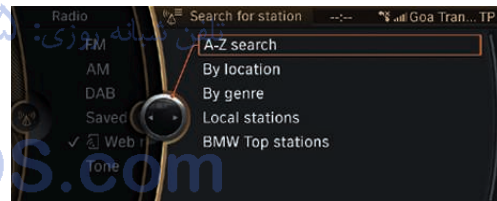

BMW Apps lets you access Social Networks, music PlugIn and Video Playback through your iPhone, and see them on the Display screen! Tune in to **Web radio** and search for stations from around the globe by name, location or genre. You can also store your favorite stations, find similar stations, display station information, and change the quality of the audio. Your favorite entries are stored on your iPhone, so you can take them with you from one vehicle to another.

Please note:
 • Available in models manufactured as of April 2011.
 • Not all features available while vehicle is in motion; see dealer for details.
 • Web radio audio quality depends on the bit rate of the station, and data reception depends on your cell service. Data transfer comes over the iPhone.

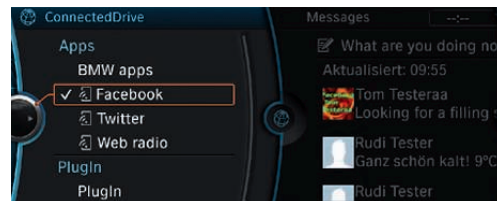

Access content from your **Twitter™** and **Facebook®** accounts to stay on top of what's happening with friends and family! The system can even read posts aloud, so you can keep your focus on the road. You can quickly post prewritten tweets that are further personalized by your BMW to let everyone know where you are and that you're enjoying the drive.

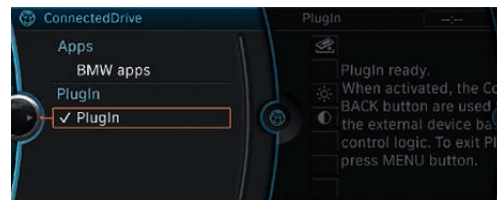

When you select **Plugin** from the BMW Apps menu, the iPhone exports a typical iPod look and control to your BMW through the video connection! You can then search for your favorite music by playlist, artist, album, song, genre or composer, just as you would on your iPhone.

Please note: The BMW App must be installed on your iPhone for the Plugin to connect.

¹Requires BMW Apps option and an iPhone.

For details on the availability of standard and optional features, please refer to the **Equipment charts** section at the back of this brochure.

TESTED IN GREEN HELL.

BMW tests every model on the Nürburgring – and the BMW 135i Coupe is no exception. From these results, engineers and designers are able to fine-tune additional modifications.



BMW test drivers completed this world-renowned racing circuit in approximately eight and a half minutes.

The track winds through 173 curves, races around steep banks and hurtles past red and white side-bumpers. Welcome to the Nordschleife test track at the Nürburgring – also known as the “Green Hell” by those who’ve experienced this unforgiving swatch of pavement. Drivers marvel at its ever-changing attractions, even though they also fear its unpredictable moods. The unique emotions evoked on the Nürburgring are echoed in every BMW: engineers dedicate many weeks every year to the track, putting BMW vehicles through their paces, the better to understand how to alter their responses. It’s not about setting records but about achieving consistently fast laps – sometimes right up to

the limit. A key element of the Nordschleife circuit is endurance testing, and no track or test facility is as well-suited as this. Just one circuit of the entire Nürburgring – with its ups and downs, wildly individual loops, variety of road surfaces, and fast and slow sections – has the same effect on the vehicle as a whole day of everyday driving.

Everything that BMW test drivers have experienced on the Nordschleife sprints has been incorporated into the BMW 1 Series Coupe.

This is not just about engine output, but agility. Impressively, the 135i Coupe easily outpaces supposedly more powerful sports cars on the loops and hairpin turns of the Nordschleife. These competitors are held back by their excess weight, overburdened front axles or lack of grip on the drive wheels. In short: they lack the perfectly balanced design of the BMW 135i Coupe.

The rear wheels, driven by BMW TwinPower Turbo technology and electronically controlled rear axle differential locking function, transfer the whole of the engine’s power onto the asphalt. Accelerating out of the narrow, slanted coils at the Nürburgring, the BMW 135i Coupe never loses an inch of traction. The available Double Clutch Transmission makes for faster and sportier gear shifts than any other system – as evidenced by the lightning-fast thrills during fast downshifting.

The unique design of the BMW 1 Series Coupe places the engine partly behind the front axle under the stretched hood.

This is how our engineers achieved perfect weight distribution between the two axles. In the compact Coupe, cornering is fast but controlled. On the Nürburgring, drivers were quick to praise the neutral, sensitive and accurate steering that is a result of the near-perfect 50/50 weight distribution. Experience



just a few laps as driven by a BMW test driver, and you’ll rapidly become aware of what dynamic driving truly means. The BMW 1 Series Coupe is a natural on the Nordschleife. And you’ll know it at every bend you take.



Dramatic meets dynamic.



Sporty by day, elegant by night: Black Sapphire Metallic paint is a sophisticated offering in the 1 Series Coupe palette. Chrome-line exterior trim and sculpted 17 x 7.0 (Style 262) Star Spoke light alloy wheels add gleaming metallic accents.

When you enter the cabin of this 128i, enchanting Oyster Boston Leather upholstery and Light Burl Walnut Wood trim provide a striking counterpoint to the dark exterior, offering a warm welcome.



The newly designed front apron of the 128i exhibits an innovative blend of form and function. BMW's Air Curtain feature funnels airflow into narrow openings on the outer sides of the front apron, then through two sealed channels. The

dispersed flow of air is released at high speed down the outer sides of the front wheels. It's a detail that boosts the sporty look of the bumper while at the same time improving fuel efficiency.

FarmaSOS.com



Exterior colors.



Upholstery colors.

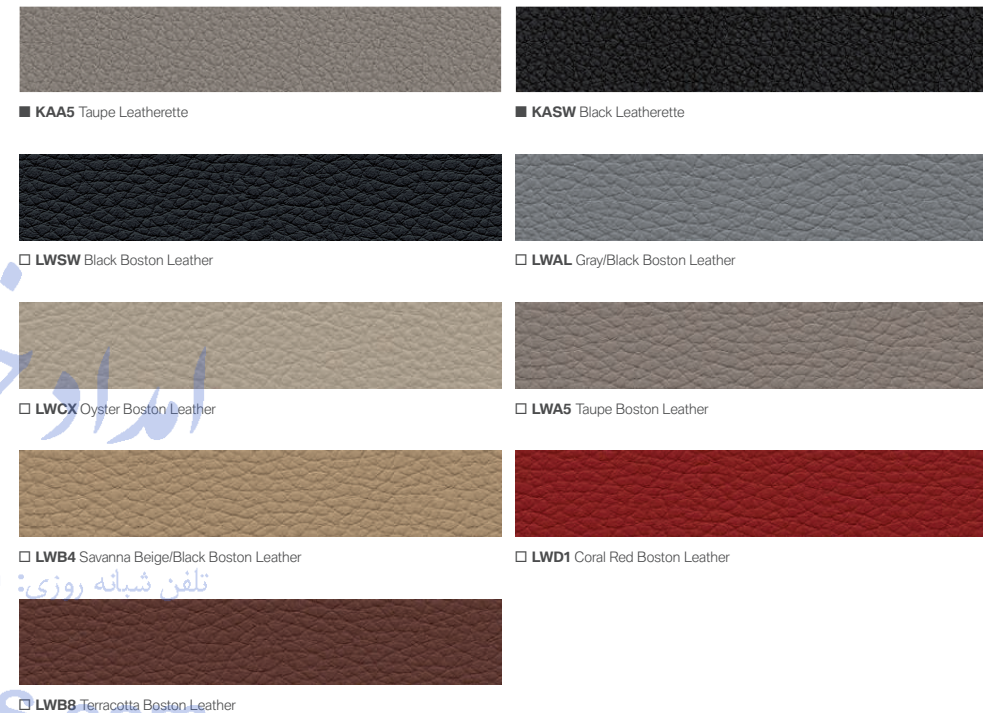

The pages in this section show available colors and materials for the BMW 1 Series Coupe. Use these samples to compare paint, upholstery, trim colors and combinations. Please note that these samples are representations; they are not exact reproductions. To see the actual colors, visit your local BMW center. They will be happy to show you original samples and assist you with special requests.

Leather upholstery covers the fronts of all seats and headrests.

¹ Not available with 128i M Sport Package.
² Requires M Sport Package.

اردو خودرو فارما
 تلفن شیانہ روزی: ۰۲۱-۸۸۸۶۲۰۸۵
 FarmaSOS.com

Interior trims.



4AT High-Gloss Black¹



4DH Alpine White²



4MG Glacier Silver Aluminum³



4A3 Light Burl Walnut Wood⁴



4AS Gray Poplar Wood⁵

Recommended color combinations.

| Materials | Leatherette ⁶ | | Boston Leather ⁷ | | | | | | |
|--|--------------------------|-------|-----------------------------|------------|--------|-------|---------------------|-----------|------------|
| | Taupe | Black | Black | Gray/Black | Oyster | Taupe | Savanna Beige/Black | Coral Red | Terracotta |
| Upholstery colors | | | | | | | | | |
| Exterior colors | | | | | | | | | |
| 300 Alpine White Non-metallic ⁵ | • | • | • | • | • | • | • | • | • |
| 668 Jet Black Non-metallic ^{5, 8} | • | • | • | • | • | • | • | • | • |
| A61 Crimson Red Non-metallic ^{5, 8} | | • | • | | • | • | | | |
| 354 Titanium Silver Metallic ⁹ | • | • | • | • | • | • | • | • | • |
| A72 Cashmere Silver Metallic ^{5, 9} | • | • | • | • | • | • | • | • | • |
| 475 Black Sapphire Metallic ⁹ | • | • | • | • | • | • | • | • | • |
| A52 Space Gray Metallic ⁹ | • | • | • | • | • | • | • | • | • |
| 896 Blue Water Metallic ^{5, 9} | | • | • | • | • | • | • | | |
| A51 Montego Blue Metallic ^{5, 9} | | • | • | • | • | • | • | • | • |
| A76 Deep Sea Blue Metallic ^{5, 9} | • | • | • | • | • | • | • | • | • |
| 381 Le Mans Blue Metallic ^{5, 10} | – | – | • | • | • | • | • | • | |
| A82 Vermilion Red Metallic ⁹ | • | • | • | • | • | • | • | • | |
| B09 Marrakesh Brown Metallic ^{5, 9} | | • | • | • | • | • | • | | |
| Interior trims | | | | | | | | | |
| 4AT High-Gloss Black ¹ | • | • | • | • | • | • | • | • | • |
| 4DH Alpine White ² | • | • | • | • | • | • | • | • | • |
| 4MG Glacier Silver Aluminum ³ | • | • | • | • | • | • | • | • | • |
| 4A3 Light Burl Walnut Wood ⁴ | • | • | • | • | • | • | • | | |
| 4AS Gray Poplar Wood ⁵ | • | • | • | • | • | • | • | • | • |

¹ Standard in 128i; optional in 135i; not available with 135i M Sport Package.

² Optional; not available with heated steering wheel.

³ Optional; 128i requires Premium Package or M Sport Package.

⁴ Optional, and included in 128i Premium Package.

⁵ Standard in 135i; optional or included in 128i Premium Package.

⁶ Standard.

⁷ Optional, and included in Premium Package.

⁸ Not available with 128i M Sport Package.

⁹ Optional.

¹⁰ Requires M Sport Package.

امداد خودرو فارما
 ۰۲۱-۸۸۸۶۲۰۸۵
 افن شاپ فروزی
 FarmaSOS.com

Standard/Optional equipment.



■/□ **Xenon Adaptive Headlights** provide brilliant clarity at night and in conditions with poor visibility. BMW Adaptive Headlights distribute optimum road illumination around corners by directing the headlights into and around the bend as soon as the vehicle begins cornering. The Corona headlight-rings that circle both headlights and high beams also act separately as Daytime Running Lights and parking lights.

□ **Automatic high beams** use light sensor readings to automatically switch from high beams to low, as needed – such as when there is oncoming traffic or another car ahead, or when the road is sufficiently illuminated.



■/□ **LED rear taillights** are made up of two separate high-performance LED strips, each consisting of multiple rows of long-life LED indicators. The LEDs in each taillight unit provide greater illumination compared to traditional bulbs.



■ **Air Curtain** on the 128i funnels airflow into narrow openings on the outer sides of the front apron, then through two sealed channels. These lead to the wheel arches, where the air is released at high speed down the outer sides of the front wheels. This reduces air resistance on the front fascia at higher speeds – which, in turn, results in increased fuel efficiency.

■ **Chrome-line exterior trim** adds a bright, distinctive look accentuating the side-window trim at the front and rear, including the window recess finishers at the base of the windows. Additional chrome inserts are also included in the door-sill finishers.



□ **Shadowline trim**, a Sport and M Sport Package feature, gives a sporty look to front and rear side-window frames, window recess finishers, and door-sill trim strips.



■/□ **Two-way power glass moonroof** with remote, expanded one-touch operation, slides backward or tilts up to let in as much fresh air and sky as you like. Includes a sliding interior sunshade.

FarmaSOS.com



■ **Halogen high- and low-beam headlights**, newly designed for the 128i, feature double headlights and free-form technology.

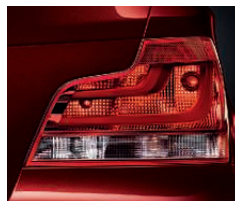

■ **Rear taillights** for the 128i incorporate a lighting design that enhances vehicle visibility at night and in inclement weather.



□ **Ambiance light package** offers lights in the exterior door handles that shine downward for approximately 20 seconds when doors are unlocked. Inside are front and rear reading lights, front footwell illumination, vanity mirror lights for driver and front passenger, and Ambiance interior lighting.



■/□ **High-intensity headlight washers** help keep lights clean of ice, mud, road salt and other coatings, for maximum road lighting and enhanced driving safety.



□ **Power-folding exterior side-view mirrors** automatically dim when reflecting bright lights, helping to eliminate glare when driving at night.



■ **Rain sensor** uses infrared light to measure the amount of rain. When the wipers are in the "intermittent" mode, the rain sensor automatically adjusts the windshield wiping interval as needed. **Automatic headlight control** (not shown), included with rain sensor, activates headlights by means of a sensor that responds to darkness.

Standard/Optional equipment.



■ **V Spoke (Style 372)** light alloy wheels and run-flat¹ performance tires.² In front: 18 x 7.5 wheels and 215/40 tires; in back: 18 x 8.5 wheels and 245/35 tires.



□ **Aero Spoke (Style 370)** light alloy wheels and run-flat¹ performance tires.² In front: 17 x 7.0 wheels and 205/50 tires; in back: 17 x 7.5 wheels and 225/45 tires.



■ **Star Spoke (Style 262)** 17 x 7.0 light alloy wheels and 205/50 run-flat¹ all-season tires.



□ **7-speed Double Clutch Transmission (DCT)** in the 135i achieves smooth, lightning-quick gear changes by automatically shifting between two transmission structures: while one gear is disengaging, the next is already in position. The result is quicker acceleration and enhanced fuel efficiency. You can also shift gears manually via steering wheel-mounted paddle shifters or by moving the gear selector lever forward/rearward.



■ **6-speed manual transmission** delivers a precise, athletic feel. Its responsiveness is due, in part, to the enhanced synchronization of shifts from neutral to each gear. A shortened shift lever and "throw" add to the sporty feel of the gearbox. The sixth gear drops revs at highway speeds for smooth cruising.



□ **6-speed STEPTRONIC automatic transmission** in the 128i offers a choice of three modes: "Drive," which incorporates BMW's Adaptive Transmission Control; "Sport" automatic, for a more dynamic shift pattern; and STEPTRONIC automatic, for the hands-on control of a manual without using a clutch.



□ **Double Spoke (Style 207M)** light alloy wheels and run-flat¹ performance tires.² In front: 17 x 7.0 wheels and 205/50 tires; in back: 17 x 7.5 wheels and 225/45 tires.



□ **Double Spoke (Style 261M)** light alloy wheels and run-flat¹ performance tires.² In front: 18 x 7.5 wheels and 215/40 tires; in back: 18 x 8.5 wheels and 245/35 tires.



□ **Star Spoke (Style 256)** 17 x 7.0 light alloy wheels and 205/50 run-flat¹ all-season tires.



■ **Three-spoke leather-wrapped multi-function sport steering wheel** lets you keep both hands on the wheel while adjusting various comfort functions, such as controls for audio system, cruise control and hands-free phone controls.

□ **Heated steering wheel** makes gloves unnecessary in cold-weather driving. A flick of the switch quickly warms the steering wheel to the perfect temperature.



□ **Three-spoke, leather-wrapped multi-function M sport steering wheel** features a grip-enhancing wheel cover and distinctive M badging. Optional Voice command (included with optional Navigation system) can be used to change various selections and entries.

¹ Run-flat tires do not come equipped with a spare tire and wheel.

² Please note: Driving over rough or damaged road surfaces, as well as debris, curbs and other obstacles, can cause serious damage to wheels, tires and suspension parts. This is more likely to occur with low-profile tires, which provide less cushioning between the wheel and the road. Be careful to avoid road hazards and reduce your speed, especially if your vehicle is equipped with low-profile tires. Performance tires are not recommended for driving in snow and ice.

For details on the availability of standard and optional features, please refer to the **Equipment charts** section at the back of this brochure.

Standard / Optional equipment.



■ **BMW anti-theft AM/FM stereo CD/MP3 player audio system** includes Radio Data System (RDS), Auto-Store, and 3-channel FM diversity antenna. It also conveniently displays song titles and other information.

■ **HD Radio™** receives free, digital AM/FM broadcasts across the U.S. in clear, static-free quality sound – AM sounds like FM; FM sounds like CD. Also enjoy “multicast” FM stations, as well as a variety of innovative data services.

For more information on HD Radio receivers and to find HD Radio AM/FM stations near you, visit HDradio.com.



■ **Cruise Control** lets you store and keep to a chosen speed above 20 mph. It is activated via the left-hand steering column switch and deactivated by applying the brakes or via the switch. (Cruise Control is not a substitute for the driver's own responsibility in adjusting speed and otherwise controlling the vehicle. Due to road, traffic and visibility conditions, the driver must decide whether and how the system is used.)



■ **Instrument panel** features a red backlit speedometer and tachometer. Centered between the two easy-to-read analog instruments is the on-board computer with liquid crystal display providing additional important driving information.



□ **Park Distance Control** uses ultrasonic sensors in the rear bumper to help you judge the distance to other cars and unseen objects when parking. The beeping becomes faster as your bumper approaches the object, turning into a constant tone when the distance is less than 12 inches. (Shown with optional BMW Navigation system.)



□ **BMW Apps**, an optional feature of the BMW ConnectedDrive interface, allows an iPhone® iOS 4.x to play apps specially modified for BMW and BMW approved third-party apps. Imagine listening to Web radio while you drive – or accessing your Twitter™ or Facebook® accounts on the Display monitor. Use the iPod Out function with your smartphone to select music tracks, compile playlists and use Genius (if enabled) to find similar sounds. **Smartphone Integration**, which provides connectivity for iPhone and similar devices, is included with BMW Apps. This allows access to stored music, can improve signal reception, and recharges the battery. (See your authorized BMW center for phone models compatible with this feature.)



□ **Sirius Satellite Radio** delivers over 130 channels of the most innovative satellite music, news, sports, talk, comedy and entertainment. All 69 music channels are commercial-free – and it's delivered coast-to-coast in crystal-clear digital sound, 24 hours a day. Add “The Best of XM” to enjoy additional premium programs, like Oprah Radio®, XM Public Radio®, The Virus®, and top-notch sports action, plus 10 channels of XM Play-by-Play sports. If your BMW is equipped with iDrive, you can also select Sirius XM channels through your vehicle's iDrive system or Voice command, and enter them into the programmable memory buttons.

فارما سودرو فارما

تلفن شبانه روزی: ۰۲۱-۸۸۸۶۲۰۸۵

FarmaSOS.com



□ **Harman Kardon® Surround Sound System** offers vehicle-specific equalizing and a powerful 300W amplifier. The 10-speaker system includes four tweeters, four midrange speakers, and two bass speakers located under the front seats.



■ **Auxiliary input port** lets you connect an external audio source, such as an iPod® or MP3 player. ■ **iPod and USB adapter** lets you scroll through and select the music you want by using the vehicle's radio controls or the multi-function steering wheel buttons. Music titles are displayed on the radio or Navigation screen.



■ **Automatic climate control system** allows occupants to select a specific cabin temperature and choice of fan speeds, as well as automatic or manual airflow and recirculation. The automatic recirculation control activates whenever certain air pollutants are detected. The system also includes defrost/demist and MAX/A/C functions.

For details on the availability of standard and optional features, please refer to the **Equipment charts** section at the back of this brochure.

Standard/Optional equipment.



■ **Cupholders** integrated into the center console are located within convenient reach of the driver and front passenger (as shown). Cars with optional Navigation system are fitted with one cupholder (shown below) in the center console, and one attached in the passenger footwell.



■ **Standard front seats**, shown here with optional Taupes Boston Leather upholstery and iDrive, offer eight-way manual adjustment including two-way adjustment of headrests. The front passenger seat also includes manual height adjustment.



■/□ **Lumbar support** for front seats adds four-way power-adjustable comfort for the lower back. Lumbar support can be adjusted up/down and in/out for an ergonomically perfect seat-back position and support of the back muscles.



■ **Rear seat backrests** can be folded individually in a 60/40 split to optimize the number of passengers and amount of cargo.



■ **Lined luggage compartment** is illuminated and can be expanded by folding down the split-folding rear seats. An elastic strap on the left-hand side, a flexible storage net on the right and lashing points on the inside edge help to ensure safe transportation of cargo.

□ **Eight-way adjustable front sport seats**, included in the Sport Package or M Sport Package, make the driving experience more enjoyable. Side bolsters can be power-adjusted to fit your back comfortably while helping to hold you firmly in place during tight cornering. Includes two-way headrests and thigh support for added support. (Shown with optional Black Boston Leather upholstery and iDrive.)



■ **Cupholders in vehicles with the optional Navigation system** are located on the center console and in the passenger footwell. The console-mounted cupholder is detachable for stowing in the glove compartment.



□ **Heated front seats** are a welcome feature for driver and front passenger in cooler weather. By pressing the icon button, seat surface and backrest are heated and quickly radiate comfortable warmth in your choice of three settings. (Heated front seats are also included in the Cold Weather Package.)



■ **Rear storage tray** built in between the two rear seats offers convenient compartments to hold items.



■/□ **Power seat adjustments** included with eight-way power front seats allow customized comfort and convenience for driver and front passenger. The two-setting memory system automatically adjusts the driver's seat and side-view mirror positions, with individual preferences available at your fingertips.



□ **Automatic dimming interior and exterior mirrors** respond to the brightness of following headlights to minimize their reflection in the eyes of the driver. The automatic anti-glare function improves safety and comfort when driving at night by helping to eliminate the eye strain from excess glare. The digital compass, integrated into the mirror, is a convenient way to constantly keep your bearings while driving. Both power-adjustable exterior mirrors include a fold-in function. The passenger-side mirror folds down to reveal the curb when the transmission is shifted into reverse gear to back up.



□ **Comfort Access system** offers convenient keyless access to your car. Simply carrying the remote key in a pocket or purse allows you to lock or unlock the doors by touching the door handle. You can also turn the engine on or off by pressing the Start/Stop button without inserting the remote key. (Foot must be on the brake; with manual transmission, clutch must also be depressed in order to start.)

The M Sport Package. An expression of superior athleticism.

Bring the proud tradition of BMW M right to your doorstep, starting with the tri-color M logo on the door sills. Bolstered front sport seats, coupled with the three-spoke M sport multi-function steering wheel¹ add to the driving excitement. The available Le Mans Blue Metallic paint and black shadowline trim project the image of serious performance. Double Spoke (Style 207M) light alloy wheels (17 x 7.0 front/17 x 7.5 rear) and run-flat performance tires² are included in the 128i M Sport Package; the 135i M Sport Package adds Double Spoke (Style 261M) light alloy wheels (18 x 7.5 front/18 x 8.5 rear) and run-flat performance tires².



Please note: Driving over rough or damaged road surfaces, as well as debris, curbs and other obstacles, can cause serious damage to wheels, tires and suspension parts. This is more likely to occur with low-profile tires, which provide less cushioning between the wheel and the road. Be careful to avoid road hazards and reduce your speed, especially if your vehicle is equipped with low-profile tires.



An **Aerodynamic kit** for the 128i matches the 135i, with its front air dam with generous air intakes, dynamic side skirts and an athletic rear spoiler. The M Sport chassis is lowered by 0.6" for tighter handling when cornering and a more aggressive look. Shadowline trim enhances the sporty attitude.

Eight-way adjustable front sport seats make the driving experience more enjoyable. Side bolsters can be power-adjusted to fit your back comfortably while helping to hold you firmly in place during cornering. Includes two-way manual headrests and thigh support.



Three-spoke, leather-wrapped multi-function M sport steering wheel is included in the M Sport Package. The thick, textured rim and thumb indents are designed for performance driving, while multi-function buttons allow you to adjust various comfort features while keeping both hands on the wheel.



M door sills with the instantly identifiable M logo. As soon as the door is opened, they announce that this is a special breed of coupe.

For details on the availability of standard and optional features, please refer to the **Equipment charts** section at the back of this brochure.



Double Spoke (Style 207M) light alloy wheels and run-flat performance tires.² In front: 17 x 7.0 wheels and 205/50 tires; in back: 17 x 7.5 wheels and 225/45 tires. (128i M Sport Package.)



Double Spoke (Style 261M) light alloy wheels and run-flat performance tires.² In front: 18 x 7.5 wheels and 215/40 tires; in back: 18 x 8.5 wheels and 245/35 tires. (135i M Sport Package.)

¹ When the 128i is ordered with M Sport Package and STEPTRONIC automatic transmission, steering wheel-mounted paddle shifters are automatically added.
² Run-flat tires do not come equipped with a spare tire and wheel; performance tires are not recommended for driving in ice and snow.

Original BMW Accessories.



Adding **black Sport stripes** underscores the 1 Series Coupe's competitive heritage. Create an even bolder high-performance look with **Double Spoke (Style 182)** 18" light alloy wheels and run-flat performance tires².



Cupholder attaches neatly to the center console within instinctive reach, so you can keep your eyes on the road while enjoying a beverage.



Floor mats are made of 100% pure rubber and provide a custom-fit. They feature deep channels to trap water, slush, snow and dirt, and will not crack, curl or stiffen in any temperature.



Apple iPhone® holder lets you connect your iPhone to the audio system, so you can stay connected without being distracted.



BMW offers a selection of custom **trunk mats** that help keep your trunk lining clean and protected.

Driving a BMW is always a special experience, which can be enhanced even further with Original BMW Accessories. Benefit from innovative solutions combining unique ideas, stunning design and supreme functionality. Discover the wide range of Original BMW Accessories available to you, enhancing such vehicle aspects as the exterior, interior, technology, transporters, protection and details to customize your vehicle. For additional information on Original BMW Accessories, please visit your authorized BMW center or

accessories.bmwusa.com

| Performance and efficiency | 128i | 135i |
|--|------|------|
| 3.0-liter dual overhead cam (DOHC), 24-valve inline 230-hp 6-cylinder engine with composite magnesium/aluminum engine block, Valvetronic, and Double-VANOS steplessly variable valve timing | ● | |
| 3.0-liter dual M Sport Package cam (DOHC), 24-valve inline turbocharged 300-hp 6-cylinder engine with TwinPower Turbo technology, piezo fuel injection, and Double-VANOS steplessly variable valve timing | | ● |
| Electronic throttle control | ● | ● |
| 6-speed manual transmission | ● | ● |
| 6-speed STEPTRONIC automatic transmission with Adaptive Transmission Control | ○ | |
| 7-speed Double Clutch Transmission (includes steering wheel-mounted paddle-shifters) | | ○ |
| Steering wheel-mounted paddle shifters (included with 7-speed Double Clutch Transmission; 128i: requires and is automatically included with STEPTRONIC automatic transmission plus Sport Package or M Sport Package) | ○ | ○ |

| Handling, ride and braking | 128i | 135i |
|---|------|------|
| Dynamic Stability Control (DSC), including Brake Fade Compensation, Start-off Assistant, Brake Drying, and Brake Stand-by features, with Dynamic Traction Control (DTC) | ● | ● |
| Extensive aluminum componentry, including front suspension components (forged-aluminum lower arms), subframe, steering rack, and brake components | ● | ● |
| Aluminum double-pivot spring and strut-type front suspension | ● | ● |
| Five-link fully independent rear suspension in lightweight steel | ● | ● |
| Front and rear anti-roll (stabilizer) bars | ● | ● |
| Twin-tube gas-pressure shock absorbers | ● | ● |
| Sport suspension calibration | □■ | ● |
| 4-wheel ventilated anti-lock disc brakes with Dynamic Brake Control (DBC) | ● | ● |
| Active Steering | | ○ |
| Increased top-speed limiter | □■ | ■ |

| Exterior and aerodynamics | 128i | 135i |
|---|------|------|
| Star Spoke (Style 262) 17 x 7.0 light alloy wheels and 205/50 run-flat ¹ all-season tires | ● | |
| V Spoke (Style 372) light alloy wheels, 18 x 7.5 front, 18 x 8.5 rear; 215/40 front, 245/35 rear run-flat ¹ performance tires ² | | ● |
| Star Spoke (Style 256) 17 x 7.0 light alloy wheels and 205/50 run-flat ¹ all-season tires (not available with M Sport Package) | | ○ |
| Aero Spoke (Style 370) light alloy wheels, 17 x 7.0 front, 17 x 7.5 rear; 205/50 front, 225/45 rear run-flat ¹ performance tires ² | □ | |
| Double Spoke (Style 207M) light alloy wheels, 17 x 7.0 front, 17 x 7.5 rear; 205/50 front, 225/45 rear run-flat ¹ performance tires ² | ■ | |
| Double Spoke (Style 261M) light alloy wheels, 18 x 7.5 front, 18 x 8.5 rear; 215/40 front, 245/35 rear run-flat ¹ performance tires ² | | ■ |
| Xenon Adaptive Headlights with auto-leveling, and Cornering Lights | ○◆ | ● |
| Automatic high beams | ○ | ○ |
| Halogen free-form front foglights | ● | |
| High-intensity headlight washers | ★ | ● |
| Heated dual power mirrors and heated windshield washer jets | ● | ● |
| Chrome-plated exhaust tips | ● | |
| Black chrome-plated exhaust tips | | ● |
| Rear spoiler | | ● |
| Aerodynamic kit | ■ | ● |
| Chrome-line exterior trim | ● | ● |
| Shadowline exterior trim | □■ | ■ |
| Metallic paint | ○ | ○ |

- Standard
- Optional
- Included in Sport Package
- Included in M Sport Package
- ◆ Included in Convenience Package
- ★ Included in Cold Weather Package
- ◇ Included in Premium Package

¹ Run-flat tires do not come equipped with a spare tire and wheel.

² Please note: Driving over rough or damaged road surfaces, as well as debris, curbs and other obstacles, can cause serious damage to wheels, tires and suspension parts. This is more likely to occur with low-profile tires, which provide less cushioning between the wheel and the road. Be careful to avoid road hazards and reduce your speed, especially if your vehicle is equipped with low-profile tires. Performance tires are not recommended for driving in ice and snow.

| Interior seating and trim | 128i | 135i |
|--|------|------|
| 8-way adjustable front seats, including 2-way headrests | ● | |
| 8-way power front seats with 2-way manual headrests and driver memory with 2 presets for seat and exterior mirror positions | ○◇ | ● |
| 8-way adjustable front sport seats with adjustable side bolsters, 2-way headrests and thigh support | □■ | ■ |
| 8-way power front sport seats with adjustable side bolsters, 2-way manual headrests and thigh support, and driver memory with 2 presets for seat and exterior mirror positions (128i: requires power seats or Premium Package) | □■ | ■ |
| 4-way adjustable power lumbar support for front seats | ◇ | ● |
| Height adjustment for front passenger seat | ● | ● |
| Leatherette upholstery | ● | ● |
| Boston Leather upholstery (covers the fronts of all seats and headrests) | ○◇ | ○◇ |
| Anthractive headliner | ■ | ■ |
| High-Gloss Black trim (135i: not available with M Sport Package) | ● | ○ |
| Gray Poplar Wood trim | ○◇ | ● |
| Light Burl Walnut Wood trim | ○◇ | ○ |
| Glacier Silver Aluminum trim (128i: requires Premium Package or M Sport Package) | ○◇ | ○ |
| Alpine White trim (not available with heated steering wheel) | ○ | ○ |
| 3-stage heated front seats | ○★ | ○★ |
| Split fold-down rear seats | ● | ● |
| M door sills with M logo, M footrest, M gear shift knob, and M handbrake lever | ■ | ■ |

| Comfort and convenience | 128i | 135i |
|---|------|------|
| Engine Start/Stop button | ● | ● |
| Comfort Access keyless entry with multi-function remote control | ○◆ | ○◆ |
| 2-way power glass moonroof with "one-touch" operation and sliding interior sunshade | ○◇ | ● |
| Automatic climate control – includes micro-filter, automatic air recirculation, left/right temperature control, MAX A/C, heat at rest, and recall of individual user settings | ● | ● |
| Front-door storage compartments | ● | ● |
| Front-seat center armrest | ● | ● |
| Front-seat cupholders | ● | ● |
| Tilt/telescopic steering-wheel column | ● | ● |
| Heated steering wheel (not available with M Sport Package or Alpine White interior trim) | ○★ | ○★ |
| Park Distance Control (PDC) (rear only) | ○◆ | ○◆ |
| Interior and power-adjustable folding exterior mirrors with automatic-dimming function | ◇ | ◇ |
| Digital compass in interior mirror | ◇ | ◇ |
| Power front windows with "one-touch" up/down operation | ● | ● |
| Cruise Control | ● | ● |
| Automatic high beams (must be ordered with Premium Package) | ○ | ○ |
| Ambiance light package, including BMW Ambiance interior lighting | ◇ | ◇ |
| Rain-sensing windshield wipers and Automatic headlight control | ● | ● |
| Integrated 3-button Universal garage-door opener | ◇ | ◇ |

| Audio system | 128i | 135i |
|--|------|------|
| Anti-theft AM/FM stereo CD/MP3 player audio system with Radio Data System (RDS) | ● | ● |
| Harman Kardon® Surround Sound Audio System with vehicle-specific equalizing and powerful 300W amplifier; the 10-speaker system includes 4 tweeters, 4 midrange speakers, and 2 bass speakers located under the front seats | ○ | ○ |
| HD Radio™ with "multicast" FM station reception | ● | ● |
| Auxiliary audio input for portable music players located in the center armrest | ● | ● |
| iPod® and USB adapter | ● | ● |
| Sirius Satellite Radio with one-year subscription | ○ | ○ |

| Instrumentation and controls | 128i | 135i |
|--|------|------|
| 3-spoke leather-wrapped multi-function sport steering wheel with audio and hands-free phone controls (if so equipped) | ● | ● |
| 3-spoke leather-wrapped multi-function M sport steering wheel with audio and hands-free phone controls (if so equipped) | ■ | ■ |
| Steering wheel-mounted paddle shifters (128i: requires and is automatically included with STEPTRONIC automatic transmission plus Sport Package or M Sport Package; 135i: requires and is automatically included with 7-speed Double Clutch Transmission) | ○ | ○ |
| Service Interval Indicator with miles-to-service readout | ● | ● |
| Check Control vehicle monitor system with pictogram display, oil status display, and Condition Based Service indicator | ● | ● |
| Tire Pressure Monitor | ● | ● |
| On-board computer with Check Control – provides feedback on the vehicle's operating status; oil level indicator and distance to next service appointment/oil change, as well as other detailed information such as micro-filter status. It also provides travel information – travel range on remaining fuel, external temperature, and more | ● | ● |
| BMW Navigation system with Voice command system and Real Time Traffic Information (where available); iDrive system with high-function on-board computer and Controller, with 6 programmable memory buttons (also includes Online Information Services when equipped with BMW Assist™) | ○ | ○ |
| BMW Apps with Smartphone Integration (requires BMW Navigation system plus Premium Package or BMW Assist) | ○ | ○ |

| Safety and security | 128i | 135i |
|--|------|------|
| Anti-lock braking system (ABS) | ● | ● |
| Adaptive Brakelights | ● | ● |
| BMW's Advanced Safety System for integrated deployment of passive and active safety systems | ● | ● |
| Front and rear Head Protection System (HPS) | ● | ● |
| Driver's and passenger's front airbag supplemental restraint system (SRS) with advanced technology; dual-threshold, dual-stage deployment; and front-passenger seat sensors designed to prevent unnecessary airbag deployment | ● | ● |
| Front passenger seat-occupation recognition with Passenger's Airbag Off indicator | ● | ● |
| Automatic safety-belt pretensioners at front seating positions | ● | ● |
| Front-seat-mounted front side-impact airbags | ● | ● |
| Interlocking door anchoring system to help protect against door intrusion in side impacts | ● | ● |
| Central locking system with center console switch (leaves gas filler door unlocked), double-lock feature and 2-step unlocking | ● | ● |
| Coded Driveaway Protection | ● | ● |
| Automatic-locking retractors (ALR) on all passenger-seat safety belts for installation of child-restraint seat | ● | ● |
| LATCH attachments for child-restraint safety installation in rear seats | ● | ● |
| Crash sensor that activates Battery Safety Terminal disconnect of alternator, fuel pump and starter from battery; automatically unlocks doors, and turns on hazard and interior lights | ● | ● |
| Programmable Daytime Running Lights | ● | ● |
| Anti-theft alarm system | ○◆ | ○◆ |
| BMW Assist Safety Plan with Bluetooth® wireless technology; includes four years of Automatic Collision Notification, Emergency Request, Enhanced Roadside Assistance, Door Unlock, Stolen Vehicle Recovery, Customer Relations, TeleService; Mobile Office features; MyInfo lets you send business locations and street addresses directly to your BMW and Navigation system (for complete details, visit bmwassist.com) | ○◆ | ○◆ |

| BMW Services | 128i | 135i |
|--|------|------|
| BMW Ultimate Service® (for complete details on BMW Ultimate Service, visit bmwusa.com/ultimateservice) | ● | ● |

| Cold Weather Package | 128i | 135i |
|--|------|------|
| 3-stage heated front seats | ○★ | ○★ |
| Heated steering wheel (not available with M Sport Package or Alpine White interior trim) | ○★ | ○★ |
| High-intensity headlight washers | ★ | ● |

● Standard
 ○ Optional
 □ Included in Sport Package
 ■ Included in M Sport Package
 ◆ Included in Convenience Package
 ★ Included in Cold Weather Package
 ◇ Included in Premium Package

³ Run-flat tires do not come equipped with a spare tire and wheel.
⁴ Please note: Driving over rough or damaged road surfaces, as well as debris, curbs and other obstacles, can cause serious damage to wheels, tires and suspension parts. This is more likely to occur with low-profile tires, which provide less cushioning between the wheel and the road. Be careful to avoid road hazards and reduce your speed, especially if your vehicle is equipped with low-profile tires. Performance tires are not recommended for driving in ice and snow.

| Premium Package | 128i | 135i |
|---|------|------|
| 8-way power front seats with 2-way manual headrests and driver memory with 2 presets for seat and exterior mirror positions | ○◇ | ● |
| 4-way adjustable power lumbar support for front seats | ◇ | ● |
| Boston Leather upholstery (covers the fronts of all seats and headrests) | ○◇ | ○◇ |
| Gray Poplar Wood trim | ○◇ | ● |
| Light Burl Walnut Wood trim | ○◇ | ○ |
| Glacier Silver Aluminum trim (128i: requires Premium Package or M Sport Package) | ○◇ | ○ |
| 2-way power glass moonroof with "one-touch" operation and sliding interior sunshade | ○◇ | ● |
| Interior and power-adjustable folding exterior mirrors with automatic-dimming function | ◇ | ◇ |
| Digital compass in interior mirror | ◇ | ◇ |
| Ambiance light package, including BMW Ambiance interior lighting | ◇ | ◇ |
| Integrated 3-button Universal garage-door opener | ◇ | ◇ |
| BMW Assist Safety Plan with Bluetooth wireless technology; includes four years of Automatic Collision Notification, Emergency Request, Enhanced Roadside Assistance, Door Unlock, Stolen Vehicle Recovery, Customer Relations, TeleService; Mobile Office features; MyInfo lets you send business locations and street addresses directly to your BMW and Navigation system (for complete details, visit bmwassist.com) | ○◇ | ○◇ |

| Sport Package (Not available with M Sport Package) | 128i | 135i |
|--|------|------|
| Aero Spoke (Style 370) light alloy wheels, 17 x 7.0 front, 17 x 7.5 rear; 205/50 front, 225/45 rear run-flat ³ performance tires ⁴ | □ | |
| 8-way adjustable front sport seats with adjustable side bolsters, 2-way headrests and thigh support | □ | |
| 8-way power front sport seats with adjustable side bolsters, 2-way manual headrests and thigh support, and driver memory with 2 presets for seat and exterior mirror positions (128i: requires power seats or Premium Package) | □ | |
| Steering wheel-mounted paddle shifters (included with 7-speed Double Clutch Transmission; 128i: requires and is automatically included with STEPTRONIC automatic transmission plus Sport Package or M Sport Package) | ○ | |
| Shadowline exterior trim | □ | |
| Increased top-speed limiter | □ | |
| Sport suspension calibration ⁴ | □ | |

| M Sport Package (Not available with Sport Package) | 128i | 135i |
|--|------|------|
| Double Spoke (Style 207M) light alloy wheels, 17 x 7.0 front, 17 x 7.5 rear; 205/50 front, 225/45 rear run-flat ³ performance tires ⁴ | ■ | |
| Double Spoke (Style 261M) light alloy wheels, 18 x 7.5 front, 18 x 8.5 rear; 215/40 front, 245/35 rear run-flat ³ performance tires ⁴ | | ■ |
| 8-way adjustable front sport seats with adjustable side bolsters, 2-way headrests and thigh support | ■ | ■ |
| 8-way power front sport seats with adjustable side bolsters, 2-way manual headrests and thigh support, and driver memory with 2 presets for seat and exterior mirror positions (128i: requires power seats or Premium Package) | ■ | ■ |
| 3-spoke leather-wrapped multi-function M sport steering wheel with audio and hands-free phone controls (if so equipped) | ■ | ■ |
| Steering wheel-mounted paddle shifters (included with 7-speed Double Clutch Transmission; 128i: requires and is automatically included with STEPTRONIC automatic transmission plus Sport Package or M Sport Package) | ○ | ○ |
| Sport suspension calibration | ■ | ● |
| Increased top-speed limiter | ■ | ■ |
| Shadowline exterior trim | ■ | ■ |
| Anthracte headliner | ■ | ■ |
| Aerodynamic kit | ■ | ● |
| M door sills with M logo, M footrest, M gear shift knob, and M handbrake lever | ■ | ■ |

| Convenience Package | 128i | 135i |
|--|------|------|
| Xenon Adaptive Headlights with auto-leveling, and Cornering Lights | ○◆ | ● |
| Comfort Access keyless entry with multi-function remote control | ○◆ | ○◆ |
| Park Distance Control (PDC) (rear only) | ○◆ | ○◆ |
| Anti-theft alarm system | ○◆ | ○◆ |

| Weight | | 128i | 135i |
|--|----|-------------|-------------|
| Unladen weight | lb | 3208 (3285) | 3373 (3439) |
| Weight distribution, front/rear | | | |
| Manual transmission | % | 50.5/49.5 | 51.6/48.4 |
| Automatic transmission (128i: STEPTRONIC transmission; 135i: 7-speed Double Clutch Transmission [DCT]) | % | 51.0/49.0 | 51.9/48.1 |
| Permitted payload | lb | 794 | 794 |
| Permitted axle load, front/rear | lb | 2028/2293 | 2116/2293 |
| Permitted roof load | lb | 165 | 165 |

| Engine | | 3.0inline 6/4 | TwinPower Turbo 3.0inline 6/4 |
|---------------------------------|-------|---------------|-------------------------------|
| Liters/type/valves per cylinder | | 3.0inline 6/4 | TwinPower Turbo 3.0inline 6/4 |
| Displacement | cu cm | 2996 | 2979 |
| Bore/Stroke | in | 3.30/3.5 | 3.31/3.53 |
| Nominal output @ rpm | hp | 230 @ 6500 | 300 @ 5800 |
| Maximum torque @ rpm | lb-ft | 200 @ 2750 | 300 @ 1300-5000 |
| Compression ratio | :1 | 10.7 | 10.2 |

| Transmission | | | |
|------------------------------------|----|---------------------|---------------------|
| Manual transmission gear ratios | | | |
| I/II/III | :1 | 4.32/2.46/1.66 | 4.11/2.32/1.54 |
| IV/V/VI/R | :1 | 1.23/1.00/0.85/3.94 | 1.18/1.00/0.85/3.73 |
| Final drive ratio | :1 | 3.23 | 3.08 |
| Automatic transmission gear ratios | | | |
| I/II/III/IV | :1 | 4.07/2.37/1.55/1.16 | 4.78/3.06/2.19/1.68 |
| V/VI/VII/R | :1 | 0.85/0.67/—/3.20 | 1.39/1.20/1.00/4.45 |
| Final drive ratio | :1 | 3.73 | 3.46 |

| Performance | | | |
|--|-----|-----------|-----------|
| Top speed ¹ | mph | 130 [150] | 130 [150] |
| Acceleration 0-60 mph ² (128i: STEPTRONIC transmission; 135i: 7-speed Double Clutch Transmission [DCT]) | sec | 6.1 (6.7) | 5.1 (5.0) |

| Fuel consumption ³ | | | |
|---|-----|-------|-------|
| Manual transmission – City/Highway | mpg | 18/28 | 20/28 |
| Automatic transmission – City/Highway (128i: STEPTRONIC transmission; 135i: 7-speed Double Clutch Transmission [DCT]) | mpg | 18/28 | 18/25 |
| Fuel tank capacity, approx. | gal | 14 | 14 |

Figures in () apply to vehicles with automatic transmission, if different from manual transmission.
Figures in [] apply to vehicles with Sport Package or M Sport Package with increased top-speed limiter.

¹ Top speed limited electronically. All-season tires limited to 130 mph.

² BMW AG test results. BMW urges you to obey all posted speed laws and always wear safety belts.

³ EPA-estimated figures are for comparison purposes only. Your actual mileage will vary, depending on speed, driving habits, trip length and driving conditions; actual mileage may be lower.

| Wheels | | 128i | 135i |
|-----------------------------|---------------|----------------------|----------------------|
| Tire dimensions – standard | front rear | 205/50 205/50 | 215/40 245/35 |
| Wheel dimensions – standard | front rear | 17 x 7.0 17 x 7.0 | 18 x 7.5 18 x 8.5 |
| Material | | light cast alloy | light cast alloy |

| Brakes | | | |
|------------------|----|------|------|
| Front – diameter | in | 11.8 | 13.3 |
| Rear – diameter | in | 11.8 | 12.8 |

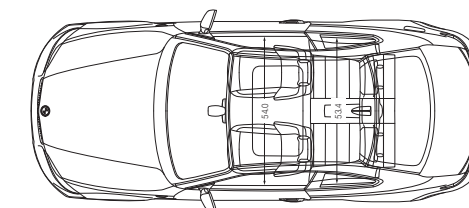
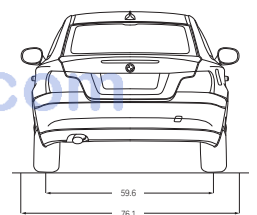
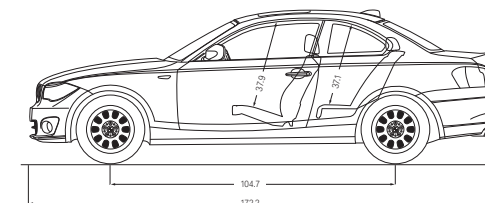
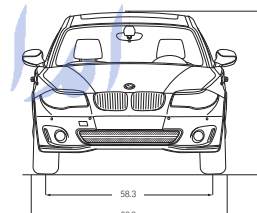

All dimensions are shown in inches and apply to 128i with standard wheels.

U.S. Importer: BMW of North America, LLC, Woodcliff Lake, NJ 07677. All illustrations and specifications contained in this brochure are based on the latest product information available at the time of printing. BMW reserves the right to make changes at any time, without notice, in colors, materials, equipment, specifications and models. BMW may, subject to legal requirements, determine the Model Year designation of its vehicles. The Model Year designation on any particular model may be longer or shorter than 12 months. Some vehicles pictured may contain non-U.S. equipment. Some models may be shown with optional equipment. While BMW NA makes all reasonable efforts to provide accurate information in this brochure, there is no guarantee or warranty of accuracy. Furthermore, we do not assume any liability for the accuracy or completeness of information presented. This brochure shall not be used or relied upon as a substitute for information that is available from your BMW center. Further information can be obtained from your authorized BMW center or bmwusa.com.

©2011 BMW of North America, LLC.

Not to be reproduced wholly or in part without written permission of BMW NA. The BMW name, logo, model names and SAV are registered trademarks.

The Bluetooth word mark and logos are owned by the Bluetooth SIG, Inc. and any use of such marks by BMW is under license. iPhone and iPod are registered trademarks of Apple Inc. Other trademarks and trade names are the property of their respective owners.

We believe that a premium ownership experience should feature performance and luxury, as well as safety and convenience. We believe you should be able to drive a BMW to its potential, while enjoying peace of mind and reduced cost of ownership. That's the idea behind **BMW Ultimate Service**[®], a suite of comprehensive programs and services that are included in every new BMW vehicle.

BMW Ultimate Service starts with the **New Vehicle Limited Warranty**,¹ providing you with coverage for the first four years or 50,000 miles, whichever comes first. Additionally, you have 12-year, unlimited-mileage warranty protection against corrosion and rust perforation.¹ The **BMW Maintenance Program**² and **BMW Roadside Assistance** also come standard, with **BMW Assist**^{TM3} offered as an option.

GOING BEYOND ENGINEERING: THE HIGH-PERFORMANCE BMW OWNERSHIP EXPERIENCE.



BMW Maintenance Program is one of the most comprehensive maintenance programs in its class. We cover all factory-recommended maintenance during the New Vehicle Limited Warranty coverage period. This includes scheduled oil services and inspections. Also covered is the replacement of items that are subject to normal wear and tear, such as brake pads, wiper blade inserts and engine drive belts.² And, thanks to BMW's advanced engineering, most owners enjoy a well-balanced maintenance schedule, with flexible routine service intervals that can save you time. When your vehicle requires attention, your authorized BMW center ensures that it receives only genuine BMW parts – your assurance of exacting quality standards.

For more details and information on BMW Ultimate Service and the BMW Maintenance Program, visit your authorized BMW center or log on to bmwusa.com/ultimateservice.



BMW Assist Safety Plan is a four-year program that lets you enjoy peace of mind knowing that a friendly response specialist is there to help you, 24/7, at just the push of a button. The Safety Plan includes Automatic Collision Notification, Emergency Request, Enhanced Roadside Assistance, Door Unlock, Stolen Vehicle Recovery and Customer Relations. Included in the BMW Assist Safety Plan, MyInfo allows you to send business locations and street addresses with their associated phone numbers from the Google MapsTM website directly to your BMW. The destination can be sent to your Navigation system for turn-by-turn directions. With the BMW Navigation system and your mobile phone linked to your BMW via Bluetooth[®] technology, BMW's Mobile Office feature transfers text messages and emails to your iDrive Display screen and reads them aloud to you. A Calendar and To-do List can also appear on your Display screen while en route. Running late? Click on the phone number in the Calendar to call your appointment. For a list of tested mobile phones, visit bmwusa.com/bluetooth.

For the ultimate in coverage, add the optional **BMW Assist Convenience Plan**.⁴ You'll enjoy unlimited access to personalized Directions, Traffic and Weather reports, as well as our Concierge feature, which can send a destination address and phone number, such as a restaurant or hotel, right to your BMW. You can make up to four operator-assisted calls per year with Critical Calling if your cell phone is not available, or if its battery is discharged. BMW Online allows access to up-to-date fuel prices and the latest weather forecasts, as well as Bloomberg's stock indices and the powerful reach of the Google Maps database – delivered to the iDrive Display right inside your vehicle.

BMW's unique **TeleService**, included in the BMW Assist Safety Plan, continually monitors specific parts that are subject to wear and tear – including the engine oil, micro-filter, spark plugs, brake linings and various fluids – as well as services that require attention at regular intervals, such as vehicle service inspections. This data is automatically transmitted to your authorized BMW center, which

will then call you to schedule a service appointment. You don't have to keep track of when your vehicle requires routine maintenance. An added benefit: any needed maintenance service parts will already be on hand, so your BMW is serviced and returned to you as quickly as possible. And because they use only Original BMW Parts, you can rely on expert fit and long-lasting BMW quality. For more details on TeleService, visit bmwassist.com.



BMW Roadside Assistance is provided free of charge for the first four years – with no mileage limit. Call **1-800-332-4BMW (4269)** for friendly on-the-road help, 24/7, anywhere in the United States, Canada and Puerto Rico. This includes everything from flat-tire changes, emergency gasoline and lock-out service, to towing, alternative transportation and even trip-interruption benefits. This service also provides valuable trip-routing advice.



BMW Financial Services. Arranging to buy or lease a BMW is easier than you may think. Your authorized BMW center offers leasing and financing to suit your personal needs through BMW Financial Services.⁵ Start the process at our website, where you can build your "dream vehicle," get an estimate on a monthly lease or financing payment, submit a credit application to BMW Financial Services – and get approval – all online.⁵ To find out how BMW Financial Services can help put you behind the wheel of your favorite BMW model, log on to bmwusa.com/fs or call, toll-free, **1-800-578-5000**.



BMW Virtual Center. If you get the sudden urge to shop for a BMW but your authorized BMW center is closed, there's good news – the BMW Virtual Center is open 24 hours a day! Log on to bmwusa.com/byo, and choose the model that interests you. Configure the BMW of your dreams, and see what the monthly payments would be. You can even send the specifications to your authorized BMW center, apply for financing, or request a test drive – all online!



BMW Magazine. A fascinating view of the latest events and products in the world of BMW, including travel reviews, personality profiles, and the latest BMW technologies. Sent to new owners and lessees several times a year, you can also read articles from **BMW Magazine** on the BMW website at bmwusa.com under the "Media Gallery & Library" heading, found in the "Experience" section.



BMW Performance Driving School. Take your driving skills to the next level. Behind the wheel of our new BMWs and under the expert guidance of professional driving instructors, you'll hone your driving skills on a versatile driving course – 1.7 miles of asphalt that can be configured in a multitude of ways. In One- and Two-Day Schools you can tackle the skid pad, slalom course and water walls. The BMW Performance Driving School is about control and pushing a BMW to its limits – and yours.

Performance Center Delivery. You'll always remember the fun of taking delivery of your new BMW – especially with BMW Performance Center Delivery in Spartanburg, SC. After enjoying dinner and an overnight stay at a first-class hotel, we'll take you and your companion to the Performance Center where a Product Specialist will give you an in-depth introduction to your new BMW. Then at the Performance Driving School, you'll get tips from a professional driving instructor as you explore the dynamic capabilities of a similar model. It's exciting, it's enlightening – and it's all compliments of BMW with your new vehicle. To learn more about the BMW Performance Center, call **1-888-345-4269** or visit bmwusa.com/performancecenter.



BMW Welt: The BMW Welt ("BMW World") delivery and brand-experience center in Munich is bold proof of BMW's passion for design. When you take advantage of the BMW European Delivery Program,⁶ this is where you will meet your new BMW – in a personalized process that is highly dramatic and totally unforgettable. (You might also realize substantial savings that just may pay for your trip.) While you're there, marvel at the historic BMWs in the Museum; learn about our engineers' newest innovations in the Technology and Design Atelier; and take a tour of the plant to experience firsthand the state-of-the-art methods used to create a BMW. Then comes the unique experience of driving your new BMW on the roads it was designed for. To learn more, visit bmwusa.com/europeandelivery.

ON-BOARD SERVICE ALERTS.

We monitor your BMW's needs – so you don't have to.

Tackling mountain switchbacks, the last thing you should be thinking about is the state of your brake pads. Thanks to BMW's integrated on-board diagnostics system, you will always know exactly when the next service is due, and what work will be required. Condition-Based Service (CBS) measures the condition of key parts that are subject to wear and tear. It also tracks fluid levels and monitors your BMW's time- and mileage-dependent service requirements. Using this data, the Info Display in the cockpit automatically alerts you in advance whenever any part of your vehicle will require servicing – so there are no surprises ahead.

¹ See your authorized BMW center for details on these limited warranties.

² The BMW Maintenance Program covers factory-recommended maintenance services as determined by the Service Interval Indicator for all new eligible MY 2004 and later BMW vehicles. Specific additional items that need replacement due to normal wear and tear are also covered. The maintenance coverage period is for the first 4 years or 50,000 miles, whichever comes first. Exclusions from coverage include: gasoline, gasoline additives, windshield washer fluid and additives, battery, tires, wheels, wheel alignment and tire balancing. All work must be performed by an authorized BMW center. See the Service and Warranty Information booklet for specific terms, conditions and limitations. Further information can also be obtained from your authorized BMW center.

³ The BMW Assist and Bluetooth Hands-free Calling system with 4 years of Safety Plan services is optional or included in the Premium Package in 1 Series models. In order to receive BMW Assist services, a subscriber agreement must be completed and transferred to the BMW Assist Response Center. GPS and underlying wireless services must be available and functioning; vehicle ignition must be turned on (except for Door Unlock and Stolen Vehicle Recovery), battery charged and connected and vehicle's electrical system operational; services may be limited to certain geographic areas. Call toll-free **1-888-333-6119**, go to bmwassist.com, or visit your authorized BMW center for additional program details. Services are subject to the terms and conditions of your subscriber agreement.

⁴ Requires BMW Assist Safety Plan subscription. Services are subject to the terms and conditions of your subscriber agreement. Please go to bmwassist.com for additional details on the optional Convenience Plan.

⁵ Subject to credit approval and other terms and conditions.

⁶ Not all models available for BMW European Delivery Program. Please go to bmwusa.com or visit your authorized BMW center for details.

More about BMW



The Ultimate
Driving Machine®

bmwusa.com
1-800-334-4BMW

امداد خودرو فارما

تلفن شماره مرکزی ۰۲۱-۸۸۸۶۲۰۸۵

FarmaSOS.com

BMW and the environment.

BMW is a strong proponent of the environment and social responsibility. We launched BMW EfficientDynamics back in 2000 – the philosophy of providing greater power with increased efficiency and fewer emissions. This has resulted in significant benefits today – for our customers, the climate and the environment.

That year, ecological sustainability was also declared one of BMW's core strategic principles; it is now firmly anchored in our entire production chain. It starts with the development of fuel-saving and alternative vehicle concepts, continues with environmentally friendly production processes, and ends with innovative recycling methods. This effort has been recognized worldwide: in 1999, BMW AG – the parent company of BMW of North America and BMW Manufacturing Co. in Spartanburg, SC – was the first automotive company to be represented on the Dow Jones Sustainability Group Index. It has remained on the Index ever since; moreover, for the last six years, BMW has been voted the world's most sustainable automobile manufacturer. At BMW, we strive for and achieve high performance in all we do.

BMW recommends Castrol

