

BMW
3 Series Sedan

320i/320i xDrive
328i/328i xDrive
328d/328d xDrive
335i/335i xDrive
ActiveHybrid 3



The Ultimate
Driving Machine®



FarmaSOS.com

THE BMW 3 SERIES SEDAN.

HIGH-PERFORMANCE HERITAGE, REDEFINED.

BMW EfficientDynamics
Less emissions. More driving pleasure.

MORE WAYS TO AMAZE.

For almost forty years it has been a clear champion on the road – as well as the heart and soul of BMW's high-performance reputation. Now in its sixth iteration, the BMW 3 Series Sedan boasts three unique personalities, each designed to highlight this popular vehicle in exhilarating ways. In addition to the 3 Series Sedan, BMW offers the Luxury Line, the Sport Line and M Sport,¹ each displaying a distinctive twist on the 3 Series formula with exclusive upholsteries, trims, wheels and other options designed to enhance the feeling of customization. It's all combined with the award-winning performance, elegance, convenience and comfort that have landed the 3 Series on critics' lists and in owners' driveways for decades. Get ready to experience the 3 Series – now perfectly suited to your own unique style.

¹ Design Lines not available on 320i and 320i xDrive models.

امداد خودرو فارما

تلفن شبانه روزی: ۰۲۱-۸۸۸۶۲۰۸۵

FarmaSOS.com





D M GC 5849

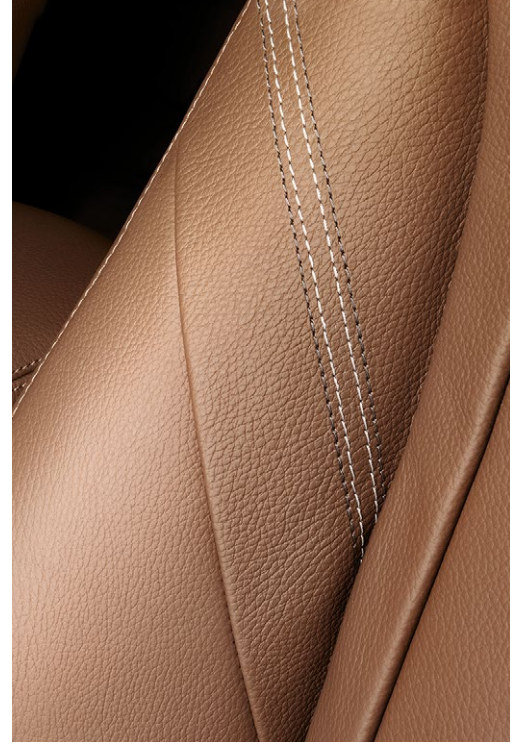

The BMW 3 Series Sedan

PROGRESS AND POWER TAKE SHAPE.

- 06 Exterior design**
Made to move you.
- 10 Interior design**
A three-way tie for first.
- 12 Driving Dynamics**
Harnessing pure power.
- 22 BMW Innovation**
The future is here today.

➔ bmwusa.com/3

Technology

ENGINEERING INNOVATIONS.

- 26 BMW ConnectedDrive®**
So connected, you're free.
- 30 BMW EfficientDynamics**
Technology that increases excitement and reduces fuel consumption and emissions.
- 32 BMW engine technology**
A heritage of innovation.
- 34 ActiveHybrid 3**
Awe-inspiring acceleration – and efficiency.
- 36 Active and passive safety features**
Innovative systems for enhanced driving confidence and security.

➔ bmwusa.com/technology

Equipment

MAKE IT AS INDIVIDUAL AS YOU ARE.

- 38 BMW 3 Series Sedan**
- 40 BMW Sport Line**
- 42 BMW Luxury Line**
- 44 BMW M Sport**
- 46 BMW 320i and 320i xDrive Sedan**
- 48 Exterior colors, upholstery colors and materials, and interior trims**
- 52 Equipment features and options**
- 62 Original BMW Accessories**
- 63 Build Your Own**

➔ bmwusa.com/byo

Get the latest information on BMW standard and optional features, packages and technical specifications. Visit bmwusa.com, select the BMW model of your choice, and click on "Features & Specs."

Equipment of 328i Sedan models shown: BMW 328i Sport Line in Melbourne Red Metallic

Engine: 2.0-liter TwinPower Turbo inline four-cylinder
Nominal output: 240 hp @ 5000-6000 rpm
Wheels: 18-inch Double Spoke light alloy (Style 397)
Upholstery: Black Dakota Leather with Red highlight
Interior trim: Aluminum with Red highlight

BMW 328i Luxury Line in Imperial Blue Metallic

Engine: 2.0-liter TwinPower Turbo inline four-cylinder
Nominal output: 240 hp @ 5000-6000 rpm
Wheels: 18-inch Multi Spoke light alloy (Style 416)
Upholstery: Saddle Brown Dakota Leather with exclusive stitching
Interior trim: Burl Walnut Wood with wood inlay and Pearl Gloss Chrome highlight

BMW 328i M Sport in Estoril Blue Metallic

Engine: 2.0-liter TwinPower Turbo inline four-cylinder
Nominal output: 240 hp @ 5000-6000 rpm
Wheels: 18-inch Star Spoke light alloy (Style 400M)
Upholstery: Black Dakota Leather
Interior trim: Aluminum Hexagon with Matte Estoril Blue highlight

For technical specifications, please see pages 64-65.



Editorial

A CLASSIC SPREADS ITS WINGS.

It has already outrun the competition, become a favorite of drivers around the world, and advanced the luxury performance heritage of BMW. So where does the BMW 3 Series go from here? It branches out.

Not content to simply deliver a fresh twist on a timeless classic, BMW expanded the personality of the 3 Series in a completely different way: with the Luxury Line, Sport Line and M Sport.¹ Each represents an opportunity for owners to fall in love with a unique vehicle by choosing the Line they feel best suits their personality. These innovative Lines provide a totally customizable vehicle that's literally designed to please.

The 3 Series Sedan offers a variety of TwinPower Turbo inline engines: six-cylinder; four-cylinder gasoline- and diesel-powered; and the BMW ActiveHybrid 3 Sedan. All are products of BMW EfficientDynamics, delivering outstanding efficiency with thrilling acceleration. The ActiveHybrid 3 is a full hybrid, combining BMW's six-cylinder turbo-charged engine with a high-performance lithium-ion battery. Torque comes on strong right from the start, for powerful, nearly silent thrust.

The 320i xDrive, 328d xDrive, 328i xDrive and 335i xDrive all offer the optimized traction of BMW's xDrive intelligent all-wheel drive. However, regardless of the Line, engine size or number of drive wheels, every 3 Series Sedan retains the same highly prized features: high-performance fuel-efficient engines and transmissions, sporty handling and suspension, and groundbreaking engineering advances, such as extensive lightweight construction and near-perfect 50/50 weight distribution. There are also many exciting features and options to enhance the look, feel, functionality and comfort of the 3 Series.

Trust BMW: good things will always come in 3s.

bmwusa.com/3

¹ Design Lines not available on 320i and 320i xDrive models.



Overviews

SPECIFICATIONS AND SERVICES.

64 Technical data

66 BMW Services

Exclusive offers for BMW customers.

bmwusa.com

For exclusive BMW photos, behind-the-scenes videos and the latest BMW news:

 Like us on Facebook®:
facebook.com/bmwusa

 Follow us on Twitter®:
twitter.com/bmwusa

 Find us on YouTube™:
youtube.com/bmwusa

 Follow us on TUMBLR®:
bmwusa.tumblr.com



**Luxury and performance take center stage
in the BMW 3 Series.**

This BMW star performer steps out in style with a breathtaking complement of enhancements and styling cues, thanks in part to the distinctive details of the three Lines.¹ There's that confident stance on the road and aggressive front end, highlighted by a unique "three-dimensional" kidney grille. And in a noteworthy design feature, the front headlights extend into the grille.

The front and rear both accentuate the vehicle's muscular silhouette, as does the slight increase in height and length over its predecessor. This translates to a more spacious interior, with more legroom and headroom. Even as it races away from sight, the L-shape taillights remind you: this 3 Series Sedan was made to move.

¹ Design Lines not available on 320i and 320i xDrive models.

Get the latest information on BMW standard and optional features, packages and technical specifications. Visit bmwusa.com, select the BMW model of your choice, and click on "Features & Specs."

تلفن شبانه روزی: ۰۲۱-۸۸۸۶۲۰۸۵

FarmaSOS.com

PROGRESS AND POWER TAKE SHAPE.



ایراد خود را با ما

تلفن: ۰۲۱-۸۸۶۲۰۸۵

FarmaSOS.com

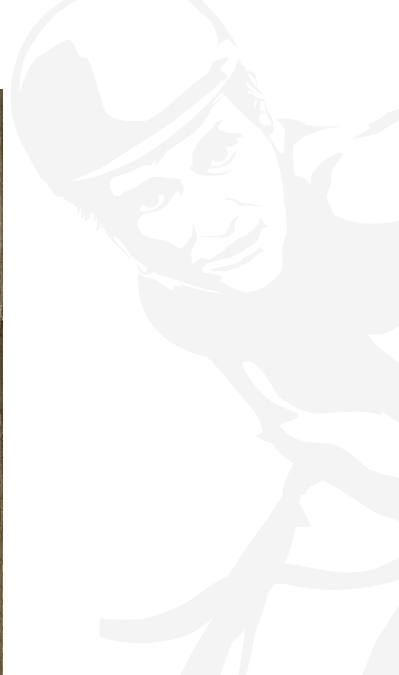

The **BMW Luxury Line** reveals the elegant side of the 3 Series. High-gloss chrome accents tastefully highlight the 11-slat kidney grille, air inlets, exhaust pipe tips and sophisticated Multi Spoke wheels.

FarmaSOS.com

BESPOKE CHARACTER: A BMW CUSTOM.

Personalized personality: the hallmark of the 3 Series.

The BMW 3 Series has always had plenty of personality to go around. Now BMW has enhanced this legendary vehicle's attitude – and its image. Three captivating, inventive Lines offer exclusive details that instantly identify the vehicle's "mood." As its name implies, the Luxury Line delivers a wealth of elegance and sophistication inside and out. And the Sport Line and M Sport adhere to the 3 Series' winning legacy on the track. All three Lines retain, at their core, the winning attributes of the 3 Series Sedan: classic contours, a sporty stance, and that BMW charisma that keeps drivers coming back for more.

Design Lines not available on 320i and 320i xDrive models. Get the latest information on BMW standard and optional features, packages and technical specifications. Visit bmwusa.com, select the BMW model of your choice, and click on "Features & Specs."



M Sport gets your pulse racing, from the wind-slicing Aerodynamic kit and shadowline exterior trim, to exclusive Star Spoke alloy wheels. Inside, the M sport steering wheel, Matte Estoril Blue highlight, sport seats and anthracite headliner remind you at all times that this is a performance-bred vehicle.



The **BMW Sport Line** shows off the athletic persona of the 3 Series with more than just a nod to its track-winning past. Sleek high-gloss black exterior trim and sporty light alloy Double Spoke wheels complement the vehicle's muscular stance, while the eight black slats of the kidney grille add an aggressive note to the front end.





امداد خودرو فارما

تلفن شبانه روزی: ۰۲۱-۸۸۸۶۲۰۸۵

FarmaSOS.com

A THREE-WAY TIE FOR FIRST.

Each BMW Line's interior displays the inner workings of a class winner.

No matter which Line you choose, the BMW 3 Series shows off its inner beauty to stunning effect. With a single look, you'll recognize the difference between each personality. Both the Sport Line and M Sport show off their natural athleticism in bold trim accent colors and eye-catching stitching. The Luxury Line creates an elegant space using a wealth of rich materials, from supple Dakota Leather upholstery to warm wood trims. Each variant has a personalized feel, along with the generous interior space and unparalleled comfort for which the 3 Series is known. It's today's way to literally get into your 3 Series vehicle – by discovering which Line speaks to you.

Design Lines not available on 320i and 320i xDrive models. Get the latest information on BMW standard and optional features, packages and technical specifications. Visit bmwusa.com, select the BMW model of your choice, and click on "Features & Specs."



The **BMW Luxury Line** imparts a sense of unparalleled sophistication, from classic upholstery colors and exclusive stitching, to Burl Walnut Wood trim with inlay.

امداد خودرو فارما

تلفن شبانه روزی: ۰۸۵ ۸۸۸۶۲۰۲۱

FarmaSOS.com

Leather upholstery: Leather on all seating surfaces; other components may be Leather or SensaTec.



The design scheme of the **BMW M Sport Line** makes effective use of bold color – as in the blue contrast stitching on the M sport steering wheel and the red illuminated rings inside the instrument dials in the dashboard. Blue or black highlights accent the trims and upholstery.

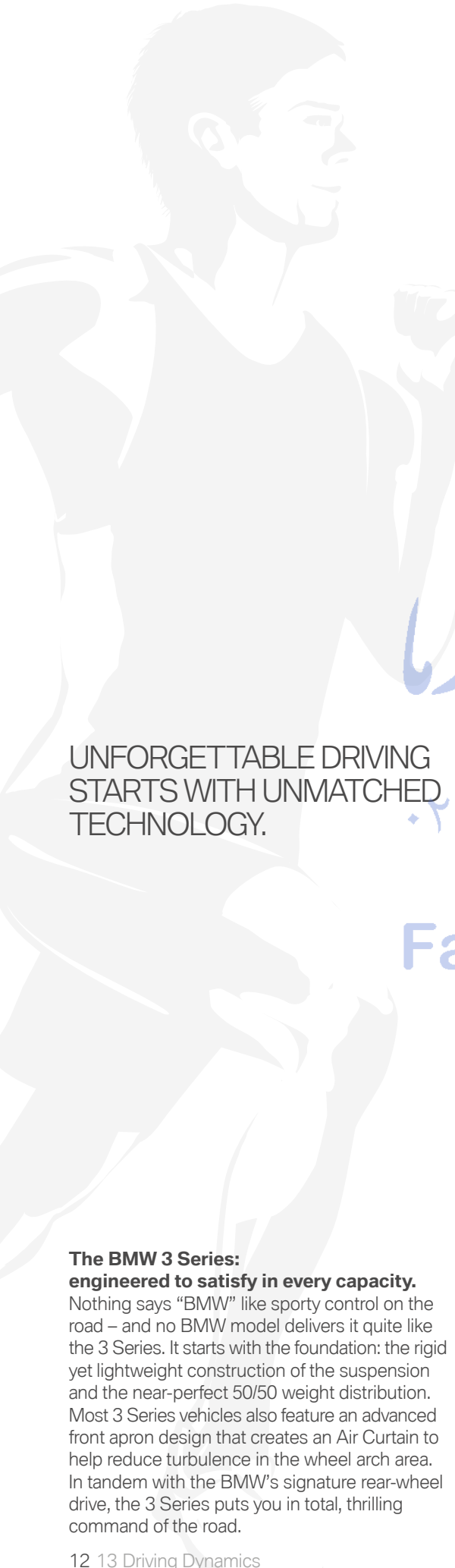

UNFORGETTABLE DRIVING STARTS WITH UNMATCHED TECHNOLOGY.

The BMW 3 Series: engineered to satisfy in every capacity.

Nothing says “BMW” like sporty control on the road – and no BMW model delivers it quite like the 3 Series. It starts with the foundation: the rigid yet lightweight construction of the suspension and the near-perfect 50/50 weight distribution. Most 3 Series vehicles also feature an advanced front apron design that creates an Air Curtain to help reduce turbulence in the wheel arch area. In tandem with the BMW’s signature rear-wheel drive, the 3 Series puts you in total, thrilling command of the road.

This responsive handling is wedded to another cutting-edge engineering advancement: Variable Sport Steering. Available on 328i, 328d and 335i rear-wheel-drive and xDrive models, as well as on the ActiveHybrid 3, this variable-ratio steering system option offers nimble, precise handling at lower speeds and more stable response at higher speeds.

Speaking of road feel, Driving Dynamics Control allows those behind the wheel to customize the driving characteristics of the 3 Series, from accelerator and engine response, to power steering characteristics and Dynamic Stability Control (DSC) thresholds. Those parameters are grouped into four different modes: COMFORT, SPORT, SPORT+ and ECO PRO, each designed to offer a different driving experience. Another button activates Dynamic Traction Control (DTC), for easier starts and stops on loose surfaces or in deep snow.

Now, with the availability of xDrive – BMW’s intelligent all-wheel-drive system – an even greater level of optimized traction is available in the 320i xDrive, 335i xDrive, 328i xDrive and 328d xDrive Sedans.

Not all features available on every model. Get the latest information on BMW standard and optional features, packages and technical specifications. Visit bmwusa.com, select the BMW model of your choice, and click on “Features & Specs.”



تلفن شبانه روزی: ۰۲۱-۸۸۸۶۲۰۸۵

FarmaSOS.com



FarmaSOS.com

THE ENGINES OF THE 3 SERIES:
MOTORWORKS OF ART.





FarmaSOS.com

The BMW 3 Series answers the question: how exciting can efficiency be?

Inspiring performance is the hallmark of every BMW 3 Series vehicle. It starts with the engine: the heart of BMW's reputation and the focal point of many technological innovations over the years.

This trend continues with the 3 Series Sedans – especially with the BMW ActiveHybrid 3. All engines incorporate our EfficientDynamics principles for peerless performance, increased efficiency and decreased emissions. All proudly feature BMW's innovative TwinPower Turbo technology for aggressive, high-revving power with smooth delivery and responsive acceleration.

In both the 335i and 335i xDrive, BMW's multi-award-winning 3.0-liter inline six-cylinder engine produces 300 hp, 300 lb-ft of torque, and a 5000-rpm redline. It's this refined power that

propels the 335i xDrive from 0-60 in a breathtaking 4.8 seconds.¹

In the 328i and 328i xDrive, BMW's acclaimed inline four-cylinder powerplant generates 240 hp and 255 lb-ft of torque. Peak torque arrives at 1250 rpm and stays strong all the way through to 4800 rpm. It's enough to rocket the 328i from standstill to 60 in just 5.7 seconds.²

Both the 328d and 328d xDrive are powered by high-efficiency BMW Advanced Diesel engines. A full 280 lb-ft of torque kicks in at just 1750 rpm, giving the Sedan urgent acceleration from a standing start, while the 180 horsepower keeps it racing through all eight gears.

The 180-hp inline four-cylinder engine in the 320i and 320i xDrive achieves a remarkable 36 mpg, highway,³ while its 200 lb-ft of torque helps it sprint from 0-60 mph in 7.1 seconds.⁴

An 8-speed automatic transmission is included with the 320i xDrive, 328d, 328d xDrive, 328i xDrive and ActiveHybrid 3, while the other models can be paired with an 8-speed automatic transmission or a 6-speed manual. Available exclusively with the Sport Line and M Sport⁵ is an 8-speed Sport Automatic transmission with paddle shifters that delivers smooth shifting and control.

The BMW ActiveHybrid 3 rockets you from 0-60 mph in a blistering 5.2 seconds.⁴ Boasting 335 hp and 330 lb-ft of torque, a temporary boost increases dynamic performance when needed without sacrificing outstanding efficiency. A hybrid-specific 8-speed automatic transmission smoothly harnesses that power while reducing background noise at high speeds and lowering fuel consumption.

¹ BMW AG test results for 335i xDrive with automatic transmission.

² BMW AG test results for 328i with manual transmission.

³ BMW AG test results for 320i.

⁴ BMW AG test results.

⁵ Design Lines not available on 320i and 320i xDrive models.

Please see pages 64-65 for detailed technical data. BMW urges you to obey all posted speed laws and always wear safety belts.

They call it a cockpit – and with good reason. The front seats of the 3 Series have the ability to transport you with an exhilarating level of control and comfort. The dash's driver-centric tilt lets you know that this vehicle caters to those behind the wheel. Start the engine; the full-color Head-up Display immediately projects a range of crucial driving information within easy

sight. The Driving Dynamics Control feature lets you select between COMFORT, SPORT, SPORT+ and an ECO PRO mode that optimizes power usage throughout the vehicle, from engine management to climate control. Enhancing the driving experience further is a growing list of standard features, including an iDrive Controller with a 6.5-inch color monitor. This is upgraded to an 8.8-inch screen and touchpad Controller in the ActiveHybrid 3 and when equipped with the Navigation system. Sync your 3 Series to your smartphone or media player quickly and easily via Bluetooth® and USB adapter.

Just as stunning as the technology are the interior's unmatched elegance and comfort. The look of the supple leather upholstery is elevated by the addition of gorgeous stitching, complementary trims and dashing accents – all exclusive to each Line¹ – for a symphony of colors and textures. Each time you grasp the multi-function sport steering wheel, you know you're sitting in command of a vehicle that's specially made for you.

Not all features available on every model. Get the latest information on BMW standard and optional features, packages and technical specifications. Visit bmwusa.com, select the BMW model of your choice, and click on "Features & Specs."

¹ Design Lines not available on 320i and 320i xDrive models.

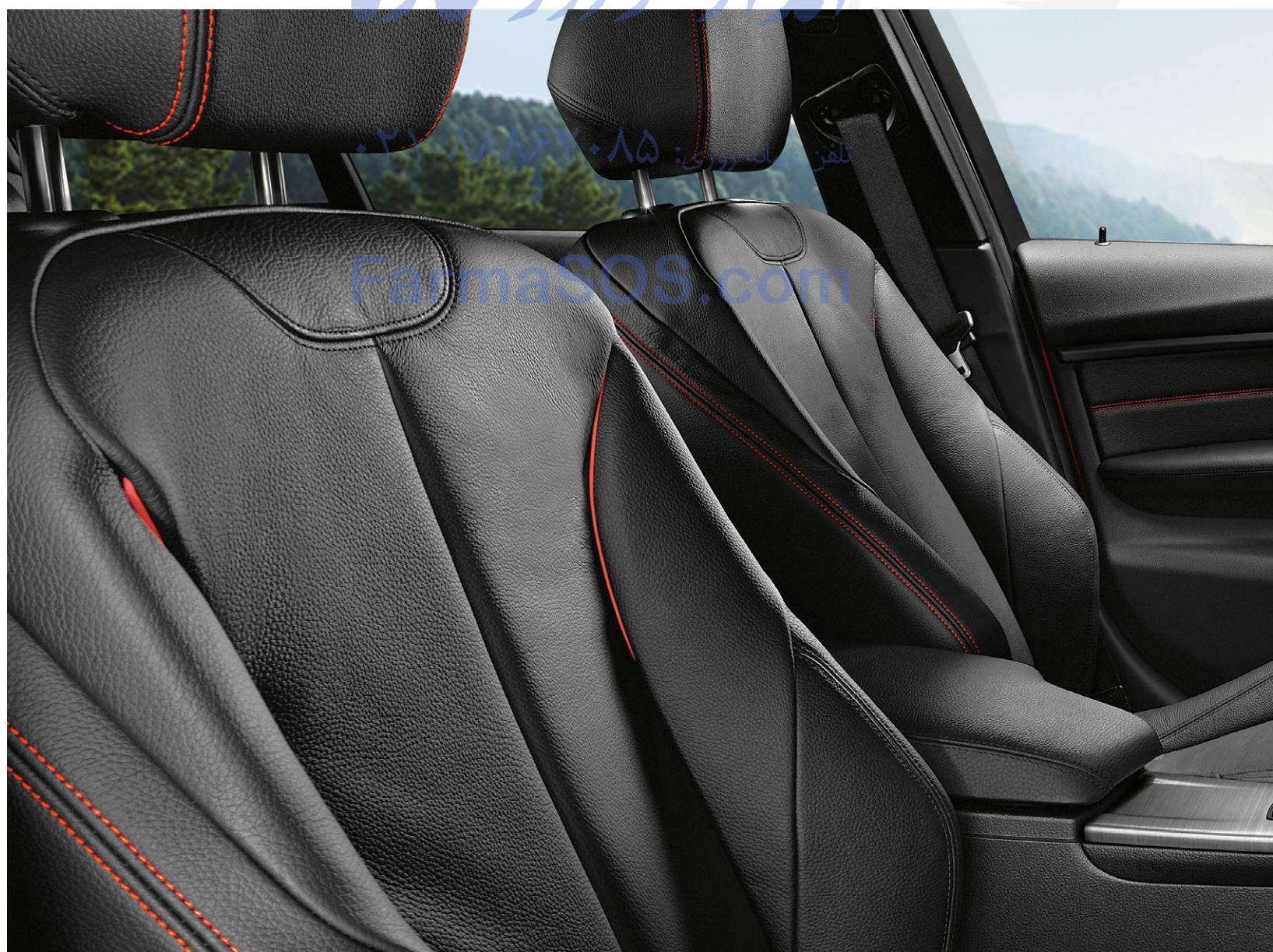



PUT YOURSELF BEHIND THE
WHEEL, AND YOU'LL GET IT.

امداد خودرو فارما

تلفن شبانه روزی: ۰۲۱-۸۸۸۶۲۰۸۵

FarmaSOS.com





FarmaSOS.com

تلفن شبانه روزی ۰۲۱-۸۶۳۰۸۸۸۸



امداد خودرو فارس

تلفن شبانه روزی: ۰۲۱-۸۸۸۶۱۰۸۵

www.masOS.com



MOVING FORWARD IS TRULY REWARDING.

Inspired technologies for new possibilities: innovations in the BMW 3 Series.

Not merely a next-generation Ultimate Driving Machine,[®] today's 3 Series Sedan is one of the most innovative creations of the BMW brand. To that end, you'll find driver-centric features, great power and efficiency, advanced driving technologies and incomparable luxury throughout each model. In the 3 Series, BMW has reset the bar for itself – and for the entire industry.

Get the latest information on BMW standard and optional features, packages and technical specifications. Visit bmwusa.com, select the BMW model of your choice, and click on "Features & Specs."



امداد خودرو فارما

تلف: شماره روزی: ۰۸۰۰۰۰۰۰۰۰

FarmaSOS

WE'VE SPENT DECADES ON SAVING GALLONS.

EfficientDynamics: how BMW defines a legacy of power.

Much more than simply a "template" for groundbreaking engineering and design, EfficientDynamics encapsulates everything BMW stands for: maximum high-performance output, with as little waste and emissions as possible. It's a process that shows up in a variety of forms, including the ECO PRO mode in the 3 Series. Accessible via Driving Dynamics Control, this innovative power management system regulates energy consumption with an unprecedented level of precision – even going so far as to alter the climate control, heated seats and exterior mirrors in order to conserve fuel by as much as 20 percent when operating at optimum efficiency. Then there's the Auto Start-Stop function, which automatically switches the engine off during short stops, such as at traffic lights. And the Brake Energy Regeneration system captures unused kinetic energy that's normally wasted when braking and coasting, and stores it in the battery.

BMW EfficientDynamics also makes its way into the more traditional features of the 3 Series. For example, the 2.0-liter TwinPower Turbo inline four-cylinder engines in the 328i and 328i xDrive and diesel-powered 328d and 328d xDrive are paragons of efficiency – as well as lively powerplants with satisfyingly responsive performance.

The BMW ActiveHybrid 3 combines a combustion engine with an electric motor and an 8-speed automatic transmission for quick acceleration and impressive fuel efficiency. And all BMW 3 Series transmissions – whether 6-speed manual, 8-speed STEPTRONIC automatic or 8-speed Sport Automatic – allow faster, smoother shifting, which uses less fuel.

Extensive use of lightweight construction throughout the 3 Series Sedan ensures a lean and muscular vehicle. Even the turbulence-reducing Air Curtain in the front apron of most 3 Series models has a hand in forwarding the EfficientDynamics mandate – proof that the BMW 3 Series is the sum of many intelligently designed components.

Not all features are available on every model. Get the latest information on BMW standard and optional features, packages and technical specifications. Visit bmwusa.com, select the BMW model of your choice, and click on "Features & Specs."

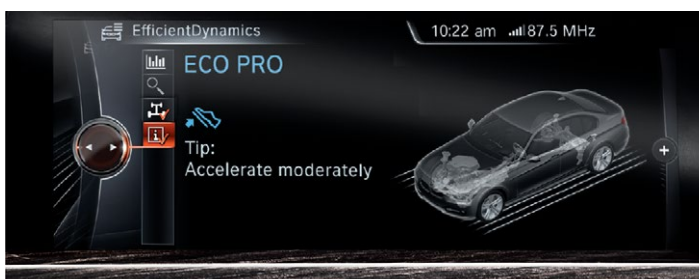

BMW ConnectedDrive®

So connected, you're free.

FIND YOURSELF – AND GET WHERE YOU'RE GOING.

From lifestyle to driving style, the technologies in the 3 Series Sedan address myriad wants and needs.

The 3 Series is all about capability and convenience. Inside, you'll find a wealth of features designed to make life easier, whether you're behind the wheel or a relaxed passenger. BMW's iDrive Controller is paired with an 8.8-inch screen and touchpad Controller in vehicles equipped with the Navigation system. The Head-up Display shows critical driving information in a brightly lit projection just above the dashboard. Like a virtual mobile office,



BMW ConnectedDrive features allow you to listen to email and tweets read aloud; make hands-free calls, store contact information and update your calendar; and so much more. Sync your compatible smartphone via Bluetooth® technology to play songs, browse your music collection and even see cover art on your iDrive screen. The thumping bass and clear trebles of the 16-speaker Harman Kardon® Surround Sound System give you a great reason to crank up your favorite driving soundtrack. You can even explore BMW Apps, specially designed for BMW owners and vehicles, to do everything from locating a restaurant to connecting to your friends via social media.

The 3 Series also exceeds expectations when it comes to driver assistance technologies. The Speed Limit Info feature uses cameras to "see" posted speed limit signs, and alerts you if you've approached or surpassed those limits. Active Blind Spot Detection and Lane Departure Warning,¹ a component of Active Driving Assistant, notify you when you are in danger of changing lanes in hazardous situations, or drifting from your lane. Parking Assistant makes use of a series of mounted cameras to help you find and get into a parking spot.

¹ Requires clearly definable lane markings that are not obscured by rain, snow, etc. Lane Departure Warning feature is not a substitute for the driver's own responsibility in maintaining safe control of the vehicle.

Not all features available on every model. Get the latest information on BMW standard and optional features, packages and technical specifications. Visit bmwusa.com, select the BMW model of your choice, and click on "Features & Specs."

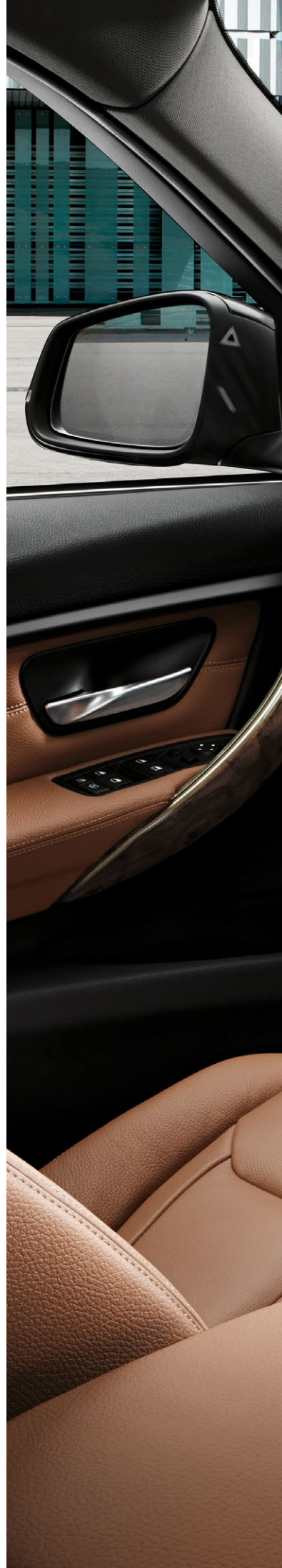
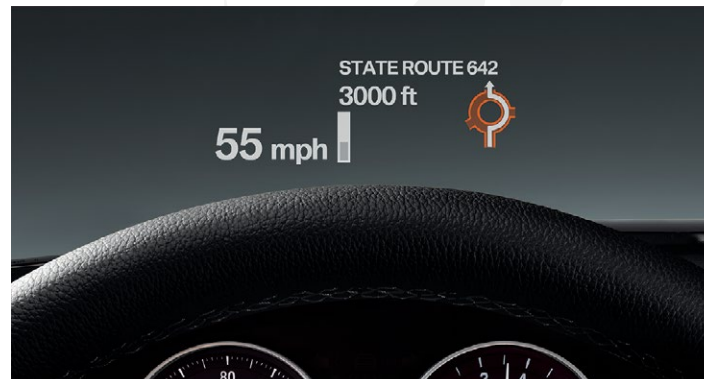



FarmaSOS.com

تلفون: ۰۲۱-۸۸۸۶۲۰۸۵



امداد خود فاما

تلفن شبانه روزی: ۰۲۱-۸۸۱۶۲۰۸۵

FarmaSOS.com



European model shown.

Leather upholstery: Leather on all seating surfaces; other components may be Leather or SensaTec.



امداد خود رانندگی THESE SEATS ARE GOING FAST.

Refined comfort has a place in high performance.

At BMW, we realize if power is the key to true performance, then comfort is the key to true luxury. The 3 Series is no exception. Regardless of the Line,¹ every inch of each vehicle is designed to please and inspire. And with more legroom and headroom than its predecessor, it's already off to a good start. Plush Dakota Leather upholstery finished with Line-specific stitching ranges from subtle to bold contrasting. Likewise, trims vary greatly depending on the Line, ranging from soft-hued Woods to sporty Aluminum Hexagon to sleek High Gloss Black and beyond. Generous front-door storage compartments can easily fit one-liter water bottles; two cupholders for the driver and front-seat passenger are standard. In the back, the rear split-folding seats provide a range of cargo-carrying options. The 3 Series Sedan also boasts the latest-generation Comfort Access system – so even with your arms full of groceries or luggage, you can simply motion with your foot toward the trunk,

and it pops open – as long as you have the key in your pocket or purse. With the 3 Series, relax – we've thought of everything.

¹ Design Lines not available on 320i and 320i xDrive models.

Not all features available on every model. Get the latest information on BMW standard and optional features, packages and technical specifications. Visit bmwusa.com, select the BMW model of your choice, and click on "Features & Specs."



BMW ConnectedDrive So connected, you're free.



Every day, our world is becoming increasingly networked. Many BMW drivers, however, are better connected than the rest, obtaining information on the road, communicating by phone or email, and always being updated on the latest events. BMW ConnectedDrive encompasses all these services, including traffic features that allow BMW vehicles and their occupants to network with the outside world.



BMW ConnectedDrive services and apps provide versatile connections between the driver, vehicle and the outside world. BMW ConnectedDrive driver assistance systems enhance your convenience, active safety and peace of mind. BMW ConnectedDrive infotainment features make every mile even more enjoyable. And most all are easily accessed and controlled through the on-board iDrive system with touchpad Controller, literally putting the world at your fingertips.

For more information, please see:

➔ bmwusa.com/connecteddrive

BMW CONNECTED DRIVE®: CONVENIENCE, INFOTAINMENT AND SAFETY TECHNOLOGIES MEET IN ONE SUITE.

With BMW ConnectedDrive you stay in touch, no matter where you go. Its advanced communications and entertainment features create a network between driver, vehicle and environment, at any time and wherever you are. The following pages present special highlights in the areas of convenience, infotainment and safety. For a comprehensive overview, see bmwusa.com/connecteddrive.



BMW ASSIST eCALL™

Enjoy peace of mind knowing that a friendly response specialist is there to help you 24/7, at the touch of a button. BMW Assist eCall includes Automatic Collision Notification, Emergency Request (SOS button) and Customer Relations.



BMW TELESERVICE.

As you're driving, the intelligent maintenance system, Condition Based Service, constantly monitors your vehicle's service needs. BMW TeleService checks your vehicle's operating fluids and wear items. When any need replacing, it automatically transmits this data and upcoming service needs to your preferred BMW center. Your BMW Service Advisor then contacts you to set up a convenient appointment, and orders parts beforehand, reducing your service and wait time.



BMW ONLINE.

BMW Online gives you a personalized internet portal, delivered on the Control Display. Get up-to-date fuel prices and gas station locations; the latest weather forecasts, advisories and warnings; Dow Jones, S&P and NASDAQ indices; and the powerful reach of the Google® database. Read or hear news headlines aloud via text-to-speech technology. "Send to Mail" pinpoints your current location and planned destination, and allows you to send the information to any email account. Split-screen functionality lets you use BMW Online in tandem with Navigation maps and instructions, entertainment details and other on-board content.



BMW APPS.

Access Social Networks, on-demand music and location sharing through your iPhone®, and see them on the Display screen.¹ Tune in to Web radio and search for stations from around the globe by name, location or genre. You can also store your favorite stations, find similar stations, display station information, and change the quality of the audio. Your favorite entries are on your iPhone, so you can take them from one vehicle to another.

¹ Requires BMW Apps option and a compatible phone. Please note:

- A broadband data link is required. The costs for this (e.g., data roaming) are regulated by the customer agreement with the mobile phone service provider.
- Not all features available while vehicle is in motion; see dealer for details.
- Web radio audio quality depends on the bit rate of the station, and data reception depends on your cell service. Data transfer comes over the mobile device.

Get the latest information on BMW standard and optional features, packages and technical specifications. Visit bmwusa.com, select the BMW model of your choice, and click on "Features & Specs."

BMW CONNECTED DRIVE® SERVICES AND APPS: EVERYTHING YOU NEED, INTELLIGENTLY NETWORKED.

Want to find the quickest route around a traffic jam? Not a problem – if you have the BMW Navigation system with Advanced Real Time Traffic Information. Need to send a note to your client? Message Dictation lets you compose and send an email or text message while you concentrate on the road. Tired of the same old playlist? Let the AUPEO! Personal Radio app introduce you to a new world of music. How about finding a French restaurant in a strange city? Let Concierge Services locate it, make a reservation for you, and send the address and phone number directly to your BMW's Navigation system. **BMW ConnectedDrive** services and apps bring a whole new level of convenience and pleasure to your drive wherever you are.

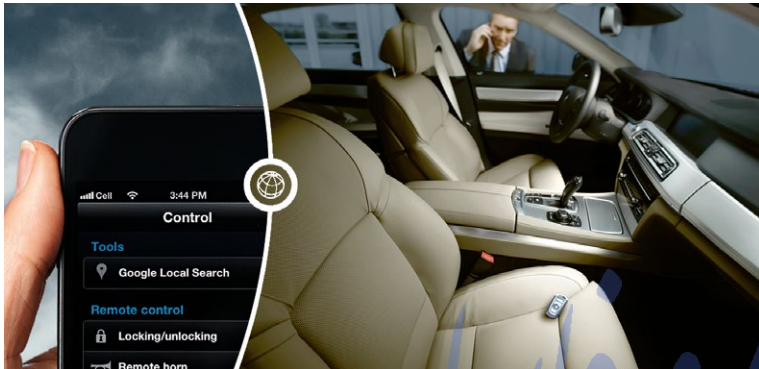

REMOTE SERVICES.

You're never far from your BMW when you have Remote Services. Locked out? Simply call the BMW Assist™ Response Center and provide your name and password, and they will unlock your driver-side door. If your BMW is stolen, file a police report, then call the BMW Assist Response Center; they will help the police locate your vehicle. (Check with your insurance company to see if this feature qualifies for a premium discount.) With the My BMW Remote app you can control your BMW from your smartphone. Lock your doors remotely; if you can't find your BMW in a parking lot, your screen will pinpoint it on a map – and on some models, even flash its lights.



ADVANCED REAL TIME TRAFFIC INFORMATION (ARTTI).

This feature, included in the iDrive 4.2 Navigation system for Model Year 2014, makes you aware of traffic congestion in most large cities before you encounter it. This feature displays and describes current local traffic information on your Control Display; in case of delays greater than five minutes, it suggests alternate routes. The latest-generation Navigation system offers numerous upgrades, such as presenting menus in virtual, 3-D spaces; added functions in the split-screen Display; switching quickly from top view to perspective view; using superimposed layers for Advanced Real Time Traffic Information and weather icons; displaying points of interest, and more.



MOBILE OFFICE.

Use the time you spend in your vehicle even more effectively with BMW's Mobile Office feature.¹ For example, text messages and emails can be transferred from your Bluetooth® paired phone directly to the vehicle's Control Display and can be read back to you aloud using text-to-speech functionality and the vehicle's audio system.

¹ Not all mobile phones are compatible with Mobile Office, and some compatible phones support a limited number of Mobile Office functions. For the complete list of compatible mobile phones and the details regarding which Mobile Office functions are supported by each phone, please visit bmwusa.com/bluetooth.



CONCIERGE SERVICES.

Wherever you travel, friendly Concierge Services representatives assist you with local restaurant and hotel recommendations, movie times and ticket information, flight arrival and departure gates and times, fuel prices and availability, and much more. You can also get the "Points of Interest" (POI) download, which allows the representative to send addresses and phone numbers to your vehicle. This information can also be transferred to your BMW Navigation system for route guidance. Then use your Bluetooth linked mobile phone to make a call.

DRIVER ASSISTANCE FEATURES: DESIGNED TO ENHANCE YOUR BMW DRIVING EXPERIENCE.

Driving a BMW isn't always the thrill of taking tight corners and accelerating onto a highway. There are the more mundane tasks of, say, finding and maneuvering into a parking space, or exiting an indoor garage onto a busy street and avoiding pedestrians you cannot see. For those times, innovative **BMW ConnectedDrive** driver assistance features make every moment behind the wheel as effortless and enjoyable as possible.



HEAD-UP DISPLAY.

The BMW Head-up Display uses a multi-color TFT to project the image toward the windshield more in your line of vision, so you can easily keep your eyes on the road while checking important travel information, such as your current speed, Check Control data and Navigation system directional arrows.



PARKING ASSISTANT.

This driver assistance system searches for suitable parking spots and then steers your vehicle into them. Simply press the "Park Assistant" button, then drive along potential parking spaces on either side of the road, staying below 22 mph and no more than five feet away. Using ultrasonic sensors integrated into the side indicators, the system searches for and measures parking spaces. When a space at least four feet longer than your vehicle is spotted, it is shown on your Control Display. Shift into reverse and Parking Assistant takes control of steering your vehicle into the selected space; you operate the accelerator and brake pedals. The acoustic and visual warnings of Park Distance Control provide assistance.



DRIVING ASSISTANCE FEATURES.

Numerous BMW ConnectedDrive features help enhance active safety. For example, when your vehicle crosses over lane markings without signaling, **Lane Departure Warning**, a component of Active Driving Assistant, warns you by sending a mild vibration through the steering wheel. **Active Blind Spot Detection**, activated when you use the turn-signal indicator before changing lanes, warns if a vehicle is in your blind spot or approaching at a high speed in the passing lane.



SPEED LIMIT INFO.

This system uses a camera installed close to the rear-view mirror to monitor speed limit signs posted above the road. Together with information supplied by the on-board Navigation system, it displays posted speed limits on the instrument cluster display and in the Head-up Display, if so equipped.

Not all features available on every model. Get the latest information on BMW standard and optional features, packages and technical specifications. Visit bmwusa.com, select the BMW model of your choice, and click on "Features & Specs."



BMW EfficientDynamics

Less emissions. More driving pleasure.

BMW was one of the first manufacturers to pursue the goal of efficient driving technologies, as part of a multi-award-winning sustainability strategy. BMW EfficientDynamics represents an acclaimed standard package of innovative technologies that reduce fuel consumption and emissions, while simultaneously enhancing dynamic performance. Since 1995 BMW has been able to reduce the CO₂ emissions of its entire fleet by approximately 30 percent and intends to achieve a further 25 percent reduction by 2020.



BMW EFFICIENT DYNAMICS: MAKING A LITTLE GO A LONG WAY.

Under the umbrella of the BMW EfficientDynamics project, BMW is continuously developing innovative systems that will bring us closer to the goal of emissions-free driving in the long term.

Eco-friendly technology. The development of more efficient vehicles powered by conventional gasoline and diesel engines are continuing challenges. A comprehensive technology directive enables the reduction of fuel consumption and emissions, while at the same time increasing power output and driving enjoyment. These advances are based on innovations such as BMW TwinPower Turbo technology, Brake Energy Regeneration, Air Curtain front apron design, and many others.

BMW ActiveHybrid. With the BMW ActiveHybrid 7, BMW ActiveHybrid 5 and BMW ActiveHybrid 3, BMW has impressive hybrid production models in its line. All combine outstanding efficiency with superlative dynamic ability.

BMW i. The all-new BMW i brand is launching two completely new vehicle concepts for sustainable mobility in an urban environment; both are an important part of BMW EfficientDynamics technologies. Key features of the BMW i3 and BMW i8 include the use of lightweight materials such as carbon-fiber-reinforced plastic (CFRP), electric drive systems, powerful battery technology and eco-friendly production methods.

➤ bmwusa.com/i
➤ bmwusa.com/EfficientDynamics

THE 3 SERIES SEDAN'S EFFICIENT DYNAMICS INITIATIVE AT A GLANCE.

Auto Start-Stop function.

Even when idling, such as at a stop sign, an engine burns fuel. BMW's Auto Start-Stop function enhances fuel efficiency by switching off the engine. (The intelligent electronics system first checks the battery charge level and calculates if other electric systems, like the heated rear window, need more energy.) Once the brake pedal is released, the engine starts up again almost instantly. A Start-Stop signal in the Display indicates the function is active.

BMW TwinPower Turbo technology.

This innovative twin-scroll turbocharging technology efficiently reclaims the energy contained in exhaust gases, using a twin-scroll charger with a double-flow exhaust system.

High Precision Direct Injection.

In this latest-generation direct fuel injection system, the piezo injectors are positioned very close to the spark plugs. They inject fuel at high pressure, with extreme precision, for very efficient combustion.

Brake Energy Regeneration.

To supply a battery with electrical energy, the generator (alternator) is usually driven using engine power, which requires fuel. With Brake Energy Regeneration, the alternator generates electricity only when you take your foot off the accelerator. Kinetic energy that was previously unharnessed is transformed into electrical energy, which is then fed into the battery. In this way, electricity is generated without consuming fuel.

Electric power steering.

Unlike conventional, hydraulic steering systems, electric power steering draws power only during actual steering movements. When the steering wheel position is constant, the electric motor is inactive.

ECO PRO mode.

Driving in ECO PRO mode helps customers achieve fuel savings of up to 20 percent, depending on their individual style of driving. This mode optimizes accelerator and transmission response as well as shift points, and intelligently adapts the heating/air conditioning strategy. ECO PRO tips help the driver drive even more efficiently. The bonus range shown by the on-board computer indicates how many additional miles the driver has gained thanks to the increased efficiency in ECO PRO mode since the last fill-up.

8-speed automatic transmission.

The close spacing of gear ratios in the 8-speed automatic transmission makes maximum use of the optimum rev range, reducing fuel consumption and allowing smoother shifts.

Lightweight construction.

Our engineers use lightweight aluminum throughout our vehicles – in the front section, for example, or for the suspension. BMW's four- and six-cylinder TwinPower Turbo engine blocks are all-aluminum. Taken together, these weight savings lead to lower fuel consumption and better axle load distribution for more agility, especially in curves.

Not all BMW EfficientDynamics features are available on all models. Please see your authorized BMW center for details.

BMW ENGINE TECHNOLOGY: A HERITAGE OF INNOVATION. A FUTURE OF SUSTAINABLE EXHILARATION.

From its inception almost a century ago as a manufacturer of aircraft engines, Bavarian Motor Works has been a world leader in engine design. In fact, the innovations shown below were so ahead of their time, BMW engineers still incorporate this technology into today's award-winning powerplants. Over the decades, BMW engines have led to countless wins at the racetrack. Even more important, their smooth, powerful and efficient performance has won over generations of driving enthusiasts. Today, adhering to the EfficientDynamics philosophy, BMW engineers are setting even higher goals: creating an engine template that can be scaled in size and adapted to new fuel sources – all while maintaining legendary BMW performance and efficiency. It's a revolutionary concept that is now becoming reality. Welcome to the exciting future of BMW power.

1936



SEMI-HEMISPHERICAL VALVE DESIGN.

A design so advanced it helped the BMW 328 Mille Miglia win races in 1936 – and it's still in use today.

1955

ALL-ALUMINUM V-8 ENGINE.

The BMW 502 applied what is now called "intelligent lightweight engineering" to its then-awesome 160-hp V-8 engine.

1972

FUEL INJECTION.

The BMW 2002tii featured fuel injection, a technology that would become a crucial building block in BMW EfficientDynamics advances.

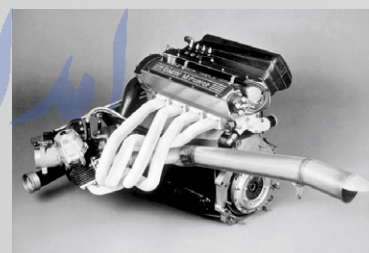

1981

DIGITAL MOTOR ELECTRONICS (DME).

Computerized engine monitoring and control revolutionize the performance, efficiency and reliability of BMW's World Championship-winning Formula 1® racecar.

1992

MULTI-VALVE TECHNOLOGY.

In every BMW, four valves per cylinder let in more air for greater power, and push out exhaust more easily for greater efficiency.

2006



ALUMINUM/MAGNESIUM COMPOSITE ENGINE BLOCK.

Technology from 1970s BMW racecar engines, this combines the strength to withstand high-revving performance with efficiency-enhancing light weight.

2007

TWIN POWER TURBO ENGINES.

BMW twin-scroll turbocharging calls on high-precision direct injection and a host of other innovations for increased power and efficiency – without turbo lag.

2008

BMW ADVANCED DIESEL WITH BLUE PERFORMANCE TECHNOLOGY.

BMW introduces America to a new form of diesel with amazing torque and power, quiet running, lower emissions and greater efficiency than ever before.

TODAY: THE BMW TWIN POWER TURBO ENGINE.

Introduced in 2007, TwinPower Turbo technology is incorporated into every new BMW engine, whether gasoline-, diesel- or hybrid-powered. Utilizing BMW high-precision direct injection, Double-VANOS continuously variable camshaft timing, and Valvetronic individual intake valve control, TwinPower Turbo technology delivers vastly increased power, torque and efficiency when compared to normally aspirated engines of the same size.

300-hp BMW TwinPower Turbo inline six-cylinder engine.

BMW GASOLINE-POWERED ENGINES.

Whether configured with four, six, eight or 12 cylinders, the latest BMW gasoline-combustion engines are designed to generate the highest ratio of power and thrilling performance to fuel consumption and emissions.

BMW ADVANCED DIESEL.

Powerful, fast, quiet and fuel-efficient: these are the traits of BMW Advanced Diesel engines. Thanks to BluePerformance Technology, BMW diesel engines meet emissions standards in all 50 states. Managed by a high-performance electronic engine control unit, the turbocharger develops boost and extra power in immediate response to the smallest tap of the accelerator pedal, and stays strong throughout the rev range where you do most of your driving.



BMW ACTIVE HYBRID.

BMW ActiveHybrid vehicles blend a TwinPower Turbo engine with an electric motor and high-performance lithium-ion battery. When compared to non-hybrid versions, BMW ActiveHybrid vehicles deliver greater fuel efficiency, fewer emissions and breathtaking acceleration.



BMW i: BORN ELECTRIC.

BMW i makes its debut with the i3. Powered by an electric motor combined with an innovative lithium-ion battery, the i3 accelerates from 0–60 in approximately 7 seconds. The BMW i8, a plug-in hybrid electric vehicle, races from 0–60 mph in 4.4 seconds. Its 131-hp electric motor powers the front wheels, while a 231-hp three-cylinder gasoline engine turns the rear wheels. Capable of 22 miles of all-electric driving using its lithium-ion battery, it achieves a total average fuel consumption of 94 mpg and a top speed of 75 mph.

THE EVOLUTION OF BMW EFFICIENT DYNAMICS TECHNOLOGY.

Smaller engines that generate greater power using less fuel.

1994 BMW 530i

3.0-liter V-8 engine with 5-speed automatic transmission

- 215 horsepower
- 16 city/25 highway mpg¹
- 0–60 mph: 8.8 seconds²

2014 BMW 528i

2.0-liter inline four-cylinder TwinPower Turbo engine with 8-speed automatic transmission

- 240 horsepower
- 23 city/34 highway mpg¹
- 0–60 mph: 6.1 seconds²

¹ EPA-estimated figures are for comparison purposes only. Your actual mileage will vary, depending on speed, driving habits, trip length and driving conditions; actual mileage may be lower.

² BMW AG test results. BMW urges you to obey all posted speed laws and always wear safety belts.

۰۲۱-۸۸۸۶۲۰۸۵
FarmaSOS.com

THE BMW ACTIVE HYBRID 3: THE STANDARD FOR SPORTY PERFORMANCE.

The world's first sports sedan is also the first and most dynamic hybrid in its class. The BMW ActiveHybrid 3 delivers the same thrilling performance as the BMW 335i, but with a dramatic increase in efficiency and a decrease in emissions. It is also the first time that BMW ActiveHybrid technology has been integrated right from the start into the design of a new vehicle. As a result, the component that usually compromises passenger and cargo space in hybrid vehicles – the battery – has been ingeniously placed under the floor of the trunk. This ensures ample storage space and use of the handy through-loading feature. In the BMW ActiveHybrid 3, there is no sacrifice in comfort or convenience.

BMW TwinPower Turbo inline six-cylinder engine: by combining an electric motor with the 3.0-liter gasoline-powered engine, the BMW ActiveHybrid 3 generates 335 hp and 330 lb-ft of torque to achieve a dynamic 0-60 time of 5.2 seconds.¹



High-performance lithium-ion battery: this highly efficient battery supplies the BMW ActiveHybrid 3 with the power needed for electric-only driving for up to 2.5 miles at speeds of up to 47 mph in ECO PRO mode. It also adds a temporary boost to the gasoline engine for even greater dynamic performance. Using an advanced form of Brake Energy Regeneration, this storage unit is recharged whenever you lift your foot off the accelerator pedal.

Auxiliary air conditioning: this enables the BMW ActiveHybrid 3 to be cooled down a few minutes before you enter the vehicle. This function is handled by an electric air conditioning compressor and does not require a single drop of fuel. It can be conveniently activated from a distance, using the vehicle's key fob.

Hybrid-specific 8-speed automatic transmission: the tightly spaced 8-speed gear ratios allow the vehicle to make better use of the optimum rev range, enhancing fuel economy and shift comfort. In combination with the Auto Start-Stop function, this increases driving comfort while greatly lowering fuel consumption and emissions.



Streamline light alloy wheels (Style 419)² with 18 x 8.0 light alloy wheels and 225/45 **run-flat³ performance tires^{4,5}** (with Sport Line: includes increased top-speed limiter) or **run-flat³ all-season tires⁴**. These exclusive, innovative aero rims help lower fuel consumption.



ActiveHybrid 3 badging behind the signature Hofmeister kink, as well as the satin aluminum window frames and window recess finishers, identify the special vehicle.



Aluminum door-sill finishers with ActiveHybrid 3 lettering lead driver and passengers into an elegant interior marked by quality workmanship.



8-speed automatic transmission gear selector lever features an aluminum surround with special ActiveHybrid 3 signature.

¹ BMW AG test results. BMW urges you to obey all posted speed laws and always wear safety belts.

² Only available as part of a Design Line. Cannot be ordered with M Sport.

³ Run-flat tires do not come equipped with a spare tire and wheel.

⁴ Driving over rough or damaged road surfaces, as well as debris, curbs and other obstacles, can cause serious damage to wheels, tires and suspension parts. This is more likely to occur with low-profile tires, which provide less cushioning between the wheel and the road. Be careful to avoid road hazards and reduce your speed, especially if your vehicle is equipped with low-profile tires.

⁵ Performance tires are not recommended for driving in snow and ice.

BMW EfficientDynamics

Less emissions. More driving pleasure.

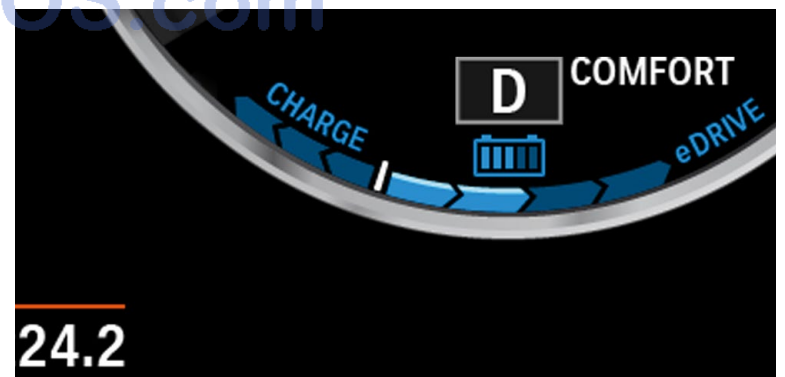
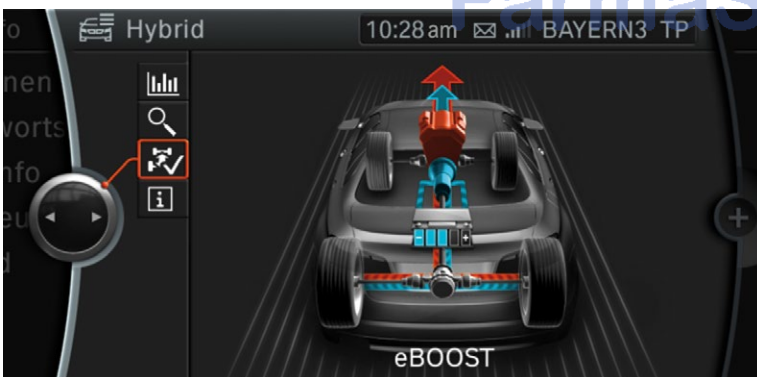

Boost function: when required, energy from the high-performance battery is used to enable a short-term boost of power. A benefit of this technology is strong and immediate power delivery.

All-electric driving: the 40 kW (55 hp) output of the electric motor allows all-electric driving over distances of up to 2.5 miles and at speeds of up to 47 mph in ECO PRO mode. After activating the ECO PRO mode via Driving Dynamics Control, the transmission uncouples the engine and shuts it off when you take your foot off the accelerator. This feature enables the BMW ActiveHybrid 3 to “sail” downhill almost silently at up to 100 mph. When the ECO PRO mode is deactivated, it is possible to sail at speeds of up to 50 mph.

Wheel and tire specifications are subject to change. Get the latest information on BMW standard and optional features, packages and technical specifications. Visit bmwusa.com, select the BMW model of your choice, and click on “Features & Specs.”

HIGH-TECH BODYGUARDS: ACTIVE AND PASSIVE SAFETY.

The 3 Series Sedan is designed with BMW's full range of state-of-the-art active and passive safety technologies. Active safety features, such as Xenon Adaptive Headlights, powerful engines and large brakes, help you see and respond to potentially dangerous situations. Should an accident prove unavoidable, passive safety features, such as airbags, are designed to help protect you and your passengers. After a severe impact, a host of features spring into action: the doors automatically unlock, headlights and taillights flash, the starter cable is disconnected from the battery and the fuel supply is cut off. Thanks to BMW Assist eCall,TM should any airbags deploy, response specialists are automatically alerted and notified of your location.

➔ bmwusa.com/3

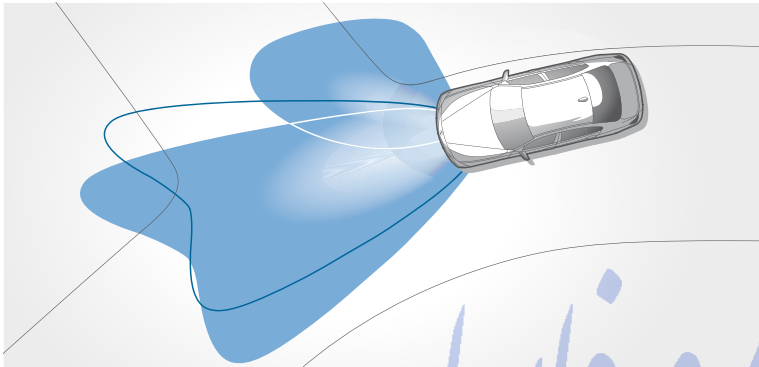

Xenon Adaptive Headlights for low- and high-beams enhance illumination of the road ahead at night or in poor visibility. Four LED Corona headlight-rings, which can be used as Daytime Running Lights, also serve as parking lights. Adaptive Headlights provide optimum illumination of the road ahead when the car enters a turn. Light distribution is automatically adapted to the road speed and steering angle. Cornering Lights, positioned in the two inner headlights, are automatically activated by using the turn indicator or changing the steering wheel angle, even when the vehicle is at rest.

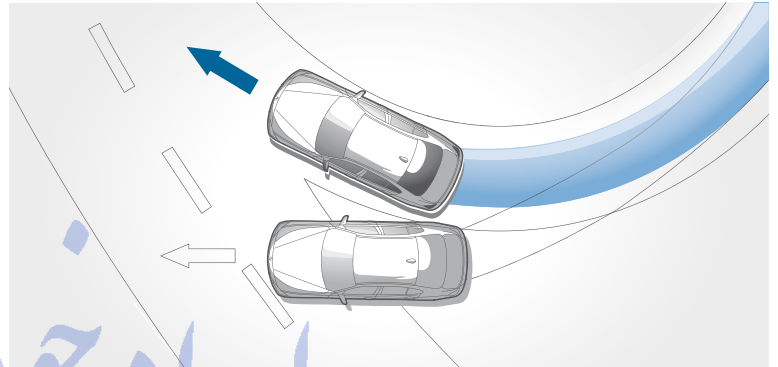

Dynamic Stability Control (DSC). This system provides remarkable tenacity on slippery road surfaces. If it senses over- or understeer, it modulates engine power and can apply brakes individually to help keep the vehicle under control and going in the intended direction. Start-off Assistant, a feature of DSC, prevents the vehicle from rolling backward on a hill for approximately 2 seconds after taking your foot off the brake. The system also includes Brake Fade Compensation, which lets you use the same amount of pedal force, even when the brakes are heated; Brake Stand-by, which pre-tenses the brakes for quicker action if you suddenly remove your foot from the accelerator pedal; and Brake Drying, which periodically brings the brake pads into contact with the rotors to eliminate accumulated moisture when it rains.

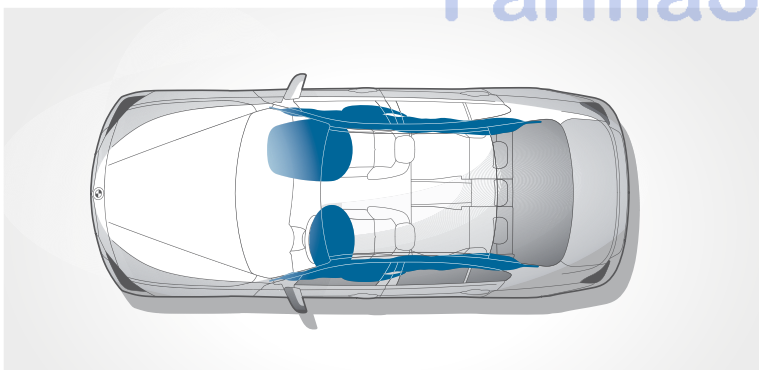

Airbags. In the event of a collision, BMW's supplemental restraint system (SRS) determines which airbag(s) to deploy for optimal protection. When a safety belt is used, airbags deploy only at a higher crash severity; the force of the deployment depends upon the severity of the impact. Eight airbags offer specific protection: front airbags with advanced technology for driver and front passenger, front knee airbags, front-seat-mounted side-impact airbags, and HPS (Head Protection System) bags for front and rear.

Note: These pictures of airbags are for illustrative purposes only. Depending upon the type of accident, none, some or all airbags may deploy.



BMW restraint system for the driver and front passenger combines three-point safety belts, automatic safety-belt pretensioners, seat bolsters that help prevent occupants from sliding forward, and Active Head Restraints. This system helps provide optimum restraint in a collision.

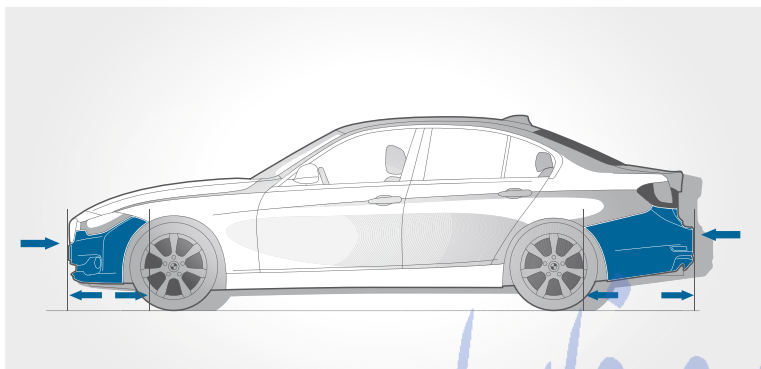

Impact-absorbing bumpers and compressible “crush tubes” front and rear help absorb the force of impact in collisions up to 9 mph, helping to minimize damage to the vehicle’s body and simplifying repairs. Only at higher impact speeds do structural supports begin to deform, dissipating impact energy to help protect occupants.

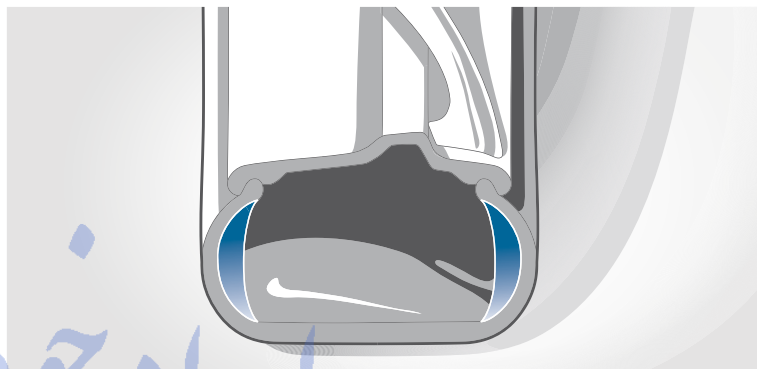

Run-flat tires. Thanks to reinforced sidewalls, run-flat tires maintain their shape and rim position even after suffering a complete loss of tire pressure. They allow you to continue driving at a reduced speed until you reach a safe area to change a tire or wait for Roadside Assistance. The Tire Pressure Monitor alerts you when there is a drop in tire pressure; if the loss is severe, an acoustic warning is triggered.

Please see Owner’s Manual for more information detailing allotted miles to travel and load weight rules for run-flat tires.

۰۲۱-۸۸۸۶۲۰۰ تلفن شبانه روزی

FarmaSOS.com

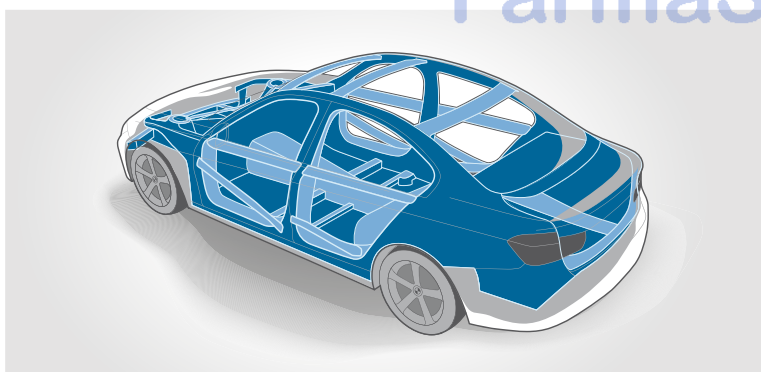

Body stiffness. The intelligent use of high-strength multi-phase steel and aluminum provides a high degree of body stiffness and crash resistance. Components such as the A-pillars and windshield frame include special reinforcements to provide optimum occupant protection. **Door reinforcements** are designed to provide additional occupant protection in the event of a side impact. Added protection is provided by diagonal safety bars in the doors. When **crash sensors** detect a serious impact, interior lights and hazard flashers activate, and the doors automatically unlock to allow access for emergency aid.

Get the latest information on BMW standard and optional features, packages and technical specifications. Visit bmwusa.com, select the BMW model of your choice, and click on “Features & Specs.”

THE 3 SERIES SEDAN.



Welcome to the command center of the 3 Series Sedan. The center console that is tilted slightly toward you hints at BMW's traditional driver-oriented design. The iDrive Control Display, leather-wrapped sport steering wheel with

multi-function buttons, and full-color Head-up Display help keep your eyes on traffic and hands on the wheel. A functional array of easy-to-read gauges and ergonomically placed controls enhance the driving experience.

Leather upholstery: Leather on all seating surfaces; other components may be Leather or SensaTec.

تلفن شبانه روزی: ۰۲۱-۸۸۸۶۲۰۸۵

FarmaSOS.com

Upholstery colors.



LCSW Black Dakota Leather



KCSW Black SensaTec



LCDF Venetian Beige Dakota Leather



KCDF Venetian Beige SensaTec

Interior trims.



4AB/4DM Dark Burl Walnut Wood with Pearl Gloss Chrome highlight



4CG Satin Silver Matte

Not all features available on every model. Wheel and tire specifications are subject to change. Get the latest information on BMW standard and optional features, packages and technical specifications. Visit bmwusa.com, select the BMW model of your choice, and click on "Features & Specs."



Front seats offer eight-way power adjustment plus two-way manual adjustment of headrests. The 3 Series Sedan's interior includes numerous handy storage compartments, including two cupholders in the center console front and back, and in-door compartments with enough room to hold assorted items within easy reach.



Star Spoke light alloy wheels (Style 393) with 17 x 7.5 and 225/50 **run-flat¹ all-season tires²** are standard on the 320i, 320i xDrive, 328i, 328i xDrive, 328d and 328d xDrive; **Star Spoke light alloy wheels (Style 396)** with 18 x 8.0 and 225/45 **run-flat¹ all-season tires²** (not shown) are standard on the 335i, 335i xDrive and ActiveHybrid 3.

¹ Run-flat tires do not come equipped with a spare tire and wheel.

² Driving over rough or damaged road surfaces, as well as debris, curbs and other obstacles, can cause serious damage to wheels, tires and suspension parts. This is more likely to occur with low-profile tires, which provide less cushioning between the wheel and the road. Be careful to avoid road hazards and reduce your speed, especially if your vehicle is equipped with low-profile tires.

FarmaSOS.com



The BMW 3 Series Sedan shown in Glacier Silver Metallic paint and Star Spoke light alloy wheels (Style 393).

THE 3 SERIES SEDAN WITH SPORT LINE.

Interior equipment features:

- Door-sill finishers in aluminum with "BMW Sport" lettering
- Leather-wrapped sport steering wheel with red contrast stitching
- Sport seats in Black SensaTec and contrasting Red highlight piping
- Dakota Leather upholstery with contrast stitching and piping
- Choice of:
 - High Gloss Black interior trim with Red highlight
 - Finition Anthracite Wood interior trim with Pearl Gloss Chrome highlight
 - Aluminum interior trim with Red or Black highlight
- Chrome trim for air conditioning and radio controls
- Instrument cluster with red highlight and red contrasting rings
- Interior illumination with variable color effects in Orange-Red or White, selected via the iDrive Controller
- Available 8-speed Sport Automatic transmission
- Anthracite headliner
- Signature key fob with red trim

Exterior equipment features:

- Choice of:
 - Double Spoke light alloy wheels (Style 397)¹ with 18 x 8.0 and 225/45 run-flat² performance tires^{3,4} (includes increased top-speed limiter) or all-season tires³
 - Optional Double Spoke light alloy wheels (Style 401) with 19 x 8.0 front, 19 x 8.5 rear and 225/40 front, 255/35 rear run-flat² performance tires^{3,4}
- Kidney grille slats, B-pillar, front and rear bumpers and air intakes specially designed in high-gloss black
- Black exterior mirror caps and chrome black exhaust pipe tips
- M sport suspension (328i, 328d and 335i)



Three-spoke leather-wrapped multi-function sport steering wheel, features a grip-enhancing cover with red decorative stitching to match the red contrasting rings surrounding the tachometer and speedometer in the instrument cluster.

تلفن شبانه روزی: ۰۲۱-۸۸۸۶۲۰۸۵

¹ 328i and 335i models come with 18-inch performance tires as standard; 328i xDrive and 335i xDrive models come with 18-inch all-season tires as standard. These tire types can be switched at no extra cost.

² Run-flat tires do not come equipped with a spare tire and wheel.

³ Driving over rough or damaged road surfaces, as well as debris, curbs and other obstacles, can cause serious damage to wheels, tires and suspension parts. This is more likely to occur with low-profile tires, which provide less cushioning between the wheel and the road. Be careful to avoid road hazards and reduce your speed, especially if your vehicle is equipped with low-profile tires.

⁴ Performance tires are not recommended for driving in ice or snow conditions.

Design Lines not available on 320i and 320i xDrive models. Wheel and tire specifications are subject to change. Get the latest information on BMW standard and optional features, packages and technical specifications. Visit bmwusa.com, select the BMW model of your choice, and click on "Features & Specs."

Upholstery colors.

Interior trims.



LCL3 Black Dakota Leather with Red highlight



4AT/4DN Black High Gloss with Red highlight



4CE/4DM Finition Anthracite Wood with Pearl Gloss Chrome highlight



LCL5 Coral Red Dakota Leather with Black highlight

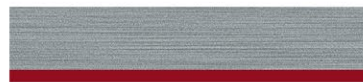

4AD/4DN Aluminum with Red highlight



KCL3 Black SensaTec with Red highlight



4AD/4DL Aluminum with Black highlight



Front sport seats offer ten-way power adjustment including two-way manual adjustment of headrests. The driver's seat provides individual adjustments for seat height and backrest, fore and aft position and seat angle.



Door-sill finishers featuring exclusive Sport Line design.



Signature key fob features the Sport Line design theme: distinctive black with contrasting red trim.



Double Spoke light alloy wheels (Style 397)¹ with 18 x 8.0 and 225/45 **run-flat² performance tires**^{3,4} (includes increased top-speed limiter) or **all-season tires**.³



Double Spoke light alloy wheels (Style 401) with 19 x 8.0 front, 19 x 8.5 rear and 225/40 front, 255/35 rear **run-flat² performance tires**.^{3,4} (Includes increased top-speed limiter.)

Leather upholstery: Leather on all seating surfaces; other components may be Leather or SensaTec.

تلفن شبانه روزی: ۰۲۱-۸۸۸۶۲۰۸۵

FarmaSOS.com



The BMW 335i Sedan with Sport Line shown in Mineral Gray Metallic paint and 18-inch Double Spoke light alloy wheels (Style 397).

THE 3 SERIES SEDAN WITH LUXURY LINE.

Interior equipment features:

- Door-sill finishers in aluminum with "BMW Luxury" lettering
- Dakota Leather upholstery with exclusive stitching
- Lower dashboard in brown color in combination with Saddle Brown Dakota Leather upholstery with exclusive stitching
- Choice of:
 - Finline Anthracite Wood interior trim with Pearl Gloss Chrome highlight
 - Burl Walnut Wood interior trim with wood inlay and Pearl Gloss Chrome highlight
- Chrome trim rings for air conditioning and radio controls
- Center console with Luxury Line exclusive chrome surround
- Interior illumination with variable color effects in Orange-Red or White, selected via the iDrive Controller
- Signature key fob with Pearl Gloss Chrome trim

Exterior equipment features:

- Choice of:
 - Multi Spoke light alloy wheels (Style 416) with 18 x 8.0 and 225/45 run-flat¹ all-season tires²
 - Optional Double Spoke light alloy wheels (Style 401) with 19 x 8.0 front, 19 x 8.5 rear and 225/40 front, 255/35 rear run-flat¹ performance tires^{2,3} (includes increased top-speed limiter)
- Front and rear bumpers and air intakes with chrome accent
- Chrome kidney grille slats
- Chrome exhaust pipe tips
- Chrome window surround

¹ Run-flat tires do not come equipped with a spare tire and wheel.

² Driving over rough or damaged road surfaces, as well as debris, curbs and other obstacles, can cause serious damage to wheels, tires and suspension parts. This is more likely to occur with low-profile tires, which provide less cushioning between the wheel and the road. Be careful to avoid road hazards and reduce your speed, especially if your vehicle is equipped with low-profile tires.

³ Performance tires are not recommended for driving in snow and ice.



The lower dashboard in an exclusive brown finish and complementing Pearl Gloss Chrome highlight trim displayed in the instrument cluster underline the sophisticated Luxury Line cabin interior.

Luxury Line requires ordering the Premium Package. Design Lines not available on 320i and 320i xDrive models. Wheel and tire specifications are subject to change. Get the latest information on BMW standard and optional features, packages and technical specifications. Visit bmwusa.com, select the BMW model of your choice, and click on "Features & Specs."

Upholstery colors.



LCLX Saddle Brown Dakota Leather with exclusive stitching



LCLY Venetian Beige Dakota Leather with exclusive stitching



LCLZ Black Dakota Leather with exclusive stitching

Interior trims.



4CE/4DM Finline Anthracite Wood with Pearl Gloss Chrome highlight



4B8/4DM Burl Walnut Wood with wood inlay and Pearl Gloss Chrome highlight



Power front seats are upholstered in supple Dakota Leather with exclusive stitching to enhance the premium look.



Door-sill finishers featuring exclusive Luxury Line design motif.



Luxury Line signature key fob with Pearl Gloss Chrome highlight trim.



Multi Spoke light alloy wheels (Style 416) with 18 x 8.0 and 225/45 run-flat¹ all-season tires.²



Double Spoke light alloy wheels (Style 401) with 19 x 8.0 front, 19 x 8.5 rear and 225/40 front, 255/35 rear run-flat¹ performance tires.^{2,3} (Includes increased top-speed limiter.)

Leather upholstery: Leather on all seating surfaces; other components may be Leather or SensaTec.

تلفن شبانه روزی: ۰۲۱-۸۸۸۶۲۰۸۵

FarmaSOS.com



The BMW 335i Sedan featuring Luxury Line and Black Sapphire Metallic paint with 18-inch Multi Spoke light alloy wheels (Style 416).

THE 3 SERIES SEDAN WITH M SPORT.

Interior equipment features:

- Door-sill finishers in aluminum with "BMW M" lettering
- Leather-wrapped multi-function M sport steering wheel
- Power sport seats for driver and front passenger
- Choice of:
 - Aluminum Hexagon interior trim with Matte Estoril Blue or High Gloss Black highlight
 - Dark Burl Walnut Wood interior trim with Pearl Gloss Chrome highlight
- Shortened gear shift lever (with manual transmission) with M logo
- Speedometer and tachometer with red readouts
- Interior illumination with variable color effects in Orange-Red or White, selected via the radio or iDrive Controller
- Anthracite headliner
- M footrest (requires black or red upholstery)
- Signature M Sport key fob with blue trim

Exterior equipment features:

- Choice of:
 - Star Spoke light alloy wheels (Style 400M) with 18 x 8.0 front, 18 x 8.5 rear and 225/45 front, 255/40 rear run-flat¹ performance tires^{2,3} (includes increased top-speed limiter)
 - Star Spoke light alloy wheels (Style 400M) with 18 x 8.0 and 225/45 run-flat¹ all-season tires²
 - Optional Star Spoke light alloy wheels (Style 403M) with 19 x 8.0 front, 19 x 8.5 rear and 225/40 front, 255/35 rear run-flat¹ performance tires^{2,3} (includes increased top-speed limiter)
- M Aerodynamic kit including front and rear bumpers
- Front air dam, rear apron, rear spoiler and side skirts
- Exclusive exterior paint color in Estoril Blue Metallic
- Shadowline exterior trim
- BMW kidney grille with eight slats in high-gloss black
- High-gloss chrome exhaust pipe tips
- M Sport suspension (328i, 328d and 335i)

Design Lines not available on 320i and 320i xDrive models. Wheel and tire specifications are subject to change. Get the latest information on BMW standard and optional features, packages and technical specifications. Visit bmwusa.com, select the BMW model of your choice, and click on "Features & Specs."



Leather-wrapped multi-function M sport steering wheel has a smaller diameter and a thicker rim for enhanced grip. The speedometer and tachometer come with a contrasting red surround.

¹ Run-flat tires do not come equipped with a spare tire and wheel.

² Driving over rough or damaged road surfaces, as well as debris, curbs and other obstacles, can cause serious damage to wheels, tires and suspension parts. This is more likely to occur with low-profile tires, which provide less cushioning between the wheel and the road. Be careful to avoid road hazards and reduce your speed, especially if your vehicle is equipped with low-profile tires.

³ Performance tires are not recommended for driving in snow and ice.

Upholstery colors.



KCSW Black SensaTec



LCSW Black Dakota Leather



KCDF Venetian Beige SensaTec



LCDF Venetian Beige Dakota Leather



LCL5 Coral Red Dakota Leather with Black highlight

Interior trims.



4MR/4DX Aluminum Hexagon with Matte Estoril Blue highlight



4MR/4DL Aluminum Hexagon with High Gloss Black highlight



4AB/4DM Dark Burl Walnut Wood with Pearl Gloss Chrome highlight



Front sport seats offer ten-way power adjustment including two-way manual adjustment of headrests. Aluminum Hexagon interior trim adds to the interior's powerful looks.

Leather upholstery: Leather on all seating surfaces; other components may be Leather or SensaTec.



Door-sill finishers featuring exclusive M Sport badge.



M Sport signature key fob with blue trim.



Star Spoke light alloy wheels (Style 400M) with **run-flat¹ all-season tires²**: 18 x 8.0 and 225/45 tires. With **run-flat¹ performance tires^{2,3}**: 18 x 8.0 front, 18 x 8.5 rear and 225/45 front, 255/40 rear tires. (Includes increased top-speed limiter.)



Star Spoke light alloy wheels (Style 403M) with 19 x 8.0 front, 19 x 8.5 rear and 225/40 front, 255/35 rear **run-flat¹ performance tires^{2,3}**. (Includes increased top-speed limiter.)

تلفن شبانه روزی: ۰۲۱-۸۸۸۶۲۰۸۵

FarmaSOS.com



powered by 

The **BMW 335i Sedan** with M Sport, shown in Estoril Blue Metallic paint with 19-inch Star Spoke light alloy wheels (Style 403M).

bmwusa.com/byo

THE 320i AND 320i xDRIVE SEDAN.

A BMW designed to meet 21st-century demands, the BMW 320i and 320i xDrive offer yet another way to experience the impressive handling and performance of the 3 Series, with an innovative engine to match. Take the wheel, and you're taking control of 180 pavement-conquering horses and 200 lb-ft of torque – thanks in large part to BMW's advanced TwinPower Turbo technology, which coaxes even more power from the muscular 2.0-liter four-cylinder engine. Coupled with an excitingly smooth 8-speed automatic transmission – or, in the 320i, the option of a 6-speed manual – the result is truly efficient high performance, as only BMW can deliver. Then personalize your Sedan with one of 12 beautiful paint colors, and enhance its performance, comfort and convenience with a choice of desirable equipment packages.



The BMW 320i is rated 36 mpg, highway,¹ demonstrating that exciting BMW performance and outstanding fuel efficiency are mutually compatible.

تلفن شبانه روزی: ۰۲۱-۸۸۸۶۲۰۸۵

FarmaSOS.com

The BMW 320i Sedan shown in Glacier Silver Metallic paint.





An elegant exterior and a spacious, comfortable interior are standard features in the BMW 320i and 320i xDrive.

تلفن شبانه روزی: ۰۲۱-۸۸۸۶۲۰۸۵



Star Spoke light alloy wheels (Style 396) with 18 x 8.0 and 225/45 run-flat² all-season tires.³



Star Spoke light alloy wheels (Style 398) with 18 x 8.0 front, 18 x 8.5 rear and 225/45 front and 255/40 rear run-flat² performance tires.^{3,4} (Includes increased top-speed limiter.)



Star Spoke light alloy wheels (Style 393) with 17 x 7.5 and 225/50 run-flat² all-season tires.³

¹ EPA-estimated figures are for comparison purposes only. Your actual mileage will vary, depending on speed, driving habits, trip length and driving conditions; actual mileage may be lower.

² Run-flat tires do not come equipped with a spare tire and wheel.

³ Driving over rough or damaged road surfaces, as well as debris, curbs and other obstacles, can cause serious damage to wheels, tires and suspension parts. This is more likely to occur with low-profile tires, which provide less cushioning between the wheel and the road. Be careful to avoid road hazards and reduce your speed, especially if your vehicle is equipped with low-profile tires.

⁴ Performance tires are not recommended for driving in snow and ice conditions.

Wheel and tire specifications are subject to change. Get the latest information on BMW standard and optional features, packages and technical specifications. Visit bmwusa.com, select the BMW model of your choice, and click on "Features & Specs."

BMW 3 SERIES SEDAN.

Exterior colors.

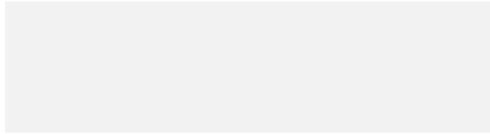

300 Alpine White (Non-metallic)



668 Jet Black (Non-metallic)

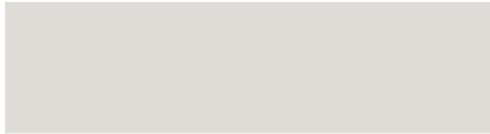

A96 Mineral White Metallic

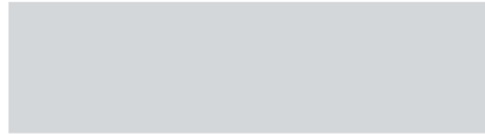

A83 Glacier Silver Metallic



B39 Mineral Gray Metallic



A75 Melbourne Red Metallic



B06 Sparkling Bronze Metallic



A17 Mojave Metallic



B40 Liquid Blue Metallic

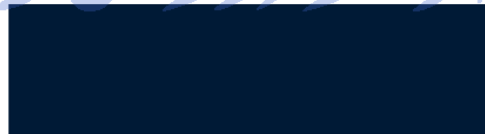

A89 Imperial Blue Metallic

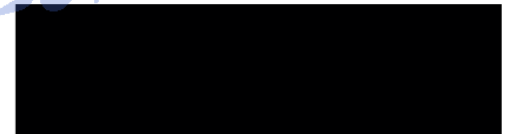

475 Black Sapphire Metallic



B45 Estoril Blue Metallic



A92 Orion Silver Metallic

The pages in this section of the brochure show available colors and materials for the BMW 3 Series Sedan. Use these samples to compare paint, upholstery, trim colors and combinations. Please note that these samples are representations; they are not exact reproductions. To see the actual colors, visit your authorized BMW center. They will be happy to show you original samples.

Upholstery colors and materials.



LCSW Black Dakota Leather



LCDF Venetian Beige Dakota Leather



KCSW Black SensaTec



KCDF Venetian Beige SensaTec

Interior trims.



4AB/4DM Dark Burl Walnut Wood with Pearl Gloss Chrome highlight



4CG Satin Silver Matte

Luxury Line. Upholstery colors.

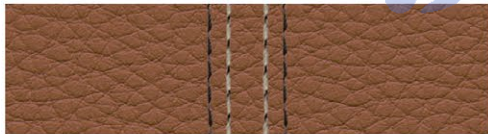

LCLX Saddle Brown Dakota Leather with exclusive stitching



LCLZ Black Dakota Leather with exclusive stitching

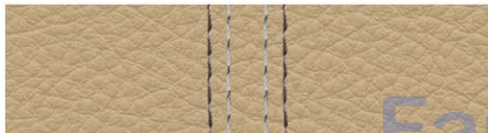

LCLY Venetian Beige Dakota Leather with exclusive stitching

Luxury Line. Interior trims.

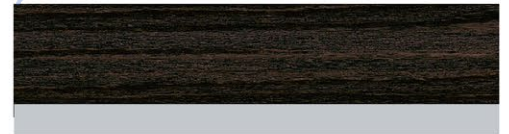

4CE/4DM Finesline Anthracite Wood with Pearl Gloss Chrome highlight



4B8/4DM Burl Walnut Wood with wood inlay and Pearl Gloss Chrome highlight

Leather upholstery: Leather on all seating surfaces; other components may be Leather or SensaTec.

Design Lines not available on 320i and 320i xDrive models. For details on the availability of standard and optional exterior paints and upholstery materials and colors, please visit bmwusa.com/byo.

Sport Line. Upholstery colors.



LCL3 Black Dakota Leather
with Red highlight



LCL5 Coral Red Dakota Leather
with Black highlight



KCL3 Black SensaTec
with Red highlight

Sport Line. Interior trims.



4CE/4DM Fineline Anthracite Wood
with Pearl Gloss Chrome highlight



4AT/4DN High Gloss Black
with Red highlight



4AD/4DN Aluminum
with Red highlight



4AD/4DL Aluminum
with Black highlight

امداد خودرو فارما

تلفن شبانه روزی: ۰۲۱-۸۸۸۶۲۰۸۵

FarmaSOS.com

The pages in this section of the brochure show available colors and materials for the BMW 3 Series Sedan. Use these samples to compare paint, upholstery, trim colors and combinations. Please note that these samples are representations; they are not exact reproductions. To see the actual colors, visit your authorized BMW center. They will be happy to show you original samples.

M Sport. Upholstery colors.



KCSW Black SensaTec

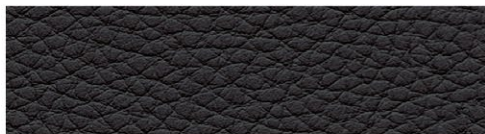

LCSW Black Dakota Leather



KCDF Venetian Beige SensaTec

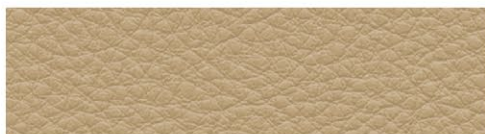

LCDF Venetian Beige Dakota Leather

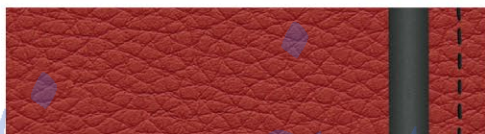

LCL5 Coral Red Dakota Leather with Black highlight



4MR/4DX Aluminum Hexagon
with Matte Estoril Blue highlight



4MR/4DL Aluminum Hexagon
with High Gloss Black highlight



4AB/4DM Dark Burl Walnut Wood
with Pearl Gloss Chrome highlight

امداد خودرو فارما

تلفن شبانه روزی: ۰۲۱-۸۸۸۶۲۰۸۵

FarmaSOS.com

Leather upholstery: Leather on all seating surfaces; other components may be Leather or SensaTec.

Design Lines not available on 320i and 320i xDrive models. For details on the availability of standard and optional exterior paints and upholstery materials and colors, please visit bmwusa.com/byo.

Equipment features and options.



Xenon Adaptive Headlights optimize road illumination when entering a turn or corner, helping to enhance visibility when driving at night. Sensors continuously monitor the angle of the steering wheel to determine the direction in which your vehicle is heading. The outer headlights swivel accordingly, up to 15 degrees left or right.

Xenon low- and high-beam headlights illuminate the road ahead and to the side. An auto-leveling feature adjusts for varying passenger and cargo loads.

Corona headlight-rings that circle both headlights and high beams also act separately as Daytime Running Lights and parking lights.

High-pressure headlight cleaning system helps keep headlights clear of ice, mud, road salt and other coatings, for maximum road illumination and enhanced driving safety. When the headlights are on, they are automatically cleaned along with the windshield.

Automatic high beams switch automatically between high and low beams according to oncoming traffic, traffic ahead, and the level of street lighting.



Taillight cluster with taillight, brakelight and turn-signal indicators incorporate LED technology for greater visibility.

Adaptive Brakelights warn following vehicles by increasing in brightness when the intensity of your braking action is increased.



Halogen free-form foglights, built into the front air dam, enhance your margin of safety in bad visibility. Ellipsoid free-form technology provides for even light distribution on the road.



Power-adjustable, folding exterior side-view mirrors in body color automatically dim when reflecting bright lights, helping to eliminate glare when driving at night.

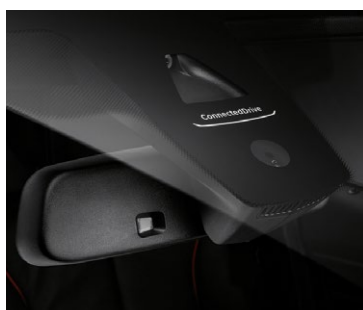

Rain sensor uses infrared light to measure the amount of rain. When the wipers are in the "intermittent" mode, the rain sensor automatically adjusts the windshield-wiping interval as needed.



Two-way power glass moonroof with one-touch operation slides backward or tilts up to let in as much fresh air and sky as you like. Includes a sliding interior sunshade.

FarmaSOS.com



Comfort Access system offers convenient keyless access to your vehicle. Carrying the remote key in a pocket or purse allows you to unlock the doors by touching the door handle. The hands-free trunk-lid opening function automatically unlocks and opens the trunk when you stand behind the vehicle and move your foot under the center of the rear bumper.



Exhaust tailpipe configuration identifies the 3 Series Sedans. There are two on the left side of the 328i and 328i xDrive; one on the left side of the 320i, 320i xDrive, 328d and 328d xDrive; on the 335i, 335i xDrive and the BMW ActiveHybrid 3, there is one tailpipe on the left and one on the right.

Equipment features and options.



Double Spoke light alloy wheels (Style 401) with 19 x 8.0 front, 19 x 8.5 rear and 225/40 front, 255/35 rear **run-flat¹ performance tires^{2,3}** (includes increased top-speed limiter).



Star Spoke light alloy wheels (Style 396) with 18 x 8.0 and 225/45 **run-flat¹ all-season tires²**.



Star Spoke light alloy wheels (Style 393) with 17 x 7.5 and 225/50 **run-flat¹ all-season tires²**.

Luxury Line.



Multi Spoke light alloy wheels (Style 416) with 18 x 8.0 and 225/45 **run-flat¹ all-season tires²**.



V Spoke light alloy wheels (Style 398) with 18 x 8.0 front, 18 x 8.5 rear and 225/45 front, 255/40 rear **run-flat¹ performance tires^{2,3}** (includes increased top-speed limiter).

Sport Line.



Multi-Spoke light alloy wheels (Style 397) with 18 x 8.0 and 225/45 **run-flat¹ all-season tires² or performance tires^{2,3}** (performance tires include increased top-speed limiter).

M Sport.



Star Spoke light alloy wheels (Style 400M). With **run-flat¹ all-season tires²**: 18 x 8.0 and 225/45 tires. With **run-flat¹ performance tires^{2,3}**: 18 x 8.0 front, 18 x 8.5 rear and 225/45 front, 255/40 rear tires (includes increased top-speed limiter).



Star Spoke light alloy wheels (Style 403M) with 19 x 8.0 front, 19 x 8.5 rear and 225/40 front, 255/35 rear **run-flat¹ performance tires^{2,3}** (includes increased top-speed limiter).

¹ Run-flat tires do not come equipped with a spare tire and wheel.

² Driving over rough or damaged road surfaces, as well as debris, curbs and other obstacles, can cause serious damage to wheels, tires and suspension parts. This is more likely to occur with low-profile tires, which provide less cushioning between the wheel and the road. Be careful to avoid road hazards and reduce your speed, especially if your vehicle is equipped with low-profile tires.

³ Performance tires are not recommended for driving in ice and snow conditions.

Design Lines not available on 320i and 320i xDrive models. Not all features available on every model. Wheel and tire specifications are subject to change. Get the latest information on BMW standard and optional features, packages and technical specifications. Visit bmwusa.com, select the BMW model of your choice, and click on "Features & Specs."



Three-spoke, leather-wrapped multi-function M sport steering wheel includes a thick, textured rim and thumb indents that are designed for performance driving. Multi-function buttons let you adjust various comfort features while keeping both hands on the wheel.

Three-spoke leather-wrapped multi-function steering wheel provides buttons on the left for operating the cruise control functions; buttons on the right adjust all audio-related functions, including Bluetooth enabled mobile phone.

Three-spoke, leather-wrapped multi-function sport steering wheel with manual tilt/telescoping feature lets you keep both hands on the wheel while adjusting both the audio and a Bluetooth® enabled mobile phone. Voice command (included with Navigation system) can be used to change audio selections, Navigation system destinations and telephone entries. **Variable Sport Steering** continuously adjusts the steering ratio, reducing the amount of steering wheel movement required in tight turns. This increases comfort when parking and maneuvering, and enhances sporty, agile handling. **Servotronic** adapts power steering support to the current speed, providing superior comfort by reducing needed steering force.



Instrument panel features a red backlit speedometer and tachometer. Centered between the two easy-to-read analog instruments is the on-board computer with liquid crystal display providing additional important driving information. **Extended instrument cluster**, included with the Navigation system, has a high-resolution Info Display showing functions for the Check Control as well as Navigation system prompts and operational feedback. With the ECO PRO mode activated, EfficientDynamics information is displayed in the rev counter.



Dynamic Cruise Control⁴ lets you set and keep to a chosen speed above 20 mph, including automatic application of the brakes when driving downhill. It is activated and regulated via controls positioned on the left side of the steering wheel, and deactivated by applying the brakes or switching off the feature.



Auto Start-Stop function switches off the engine automatically during brief stops, such as at red lights, to reduce fuel consumption. A symbol displayed in the rev counter indicates that the function is active.



On-board computer provides data on exterior temperature, average speed, average and current fuel consumption, and range. With the ECO PRO mode activated, the current bonus range is also displayed.

⁴ Cruise control is not a substitute for the driver's own responsibility in adjusting speed and otherwise controlling the vehicle. After evaluating the road, traffic and visibility conditions, the driver must decide whether and how the system is used.

Equipment features and options.



Driving Dynamics Control with ECO PRO mode lets you change the driving character of the 3 Series Sedan with just the push of a button. The switch customizes accelerator response characteristics, power steering characteristics and Dynamic Stability Control (DSC) thresholds. Choose between ECO PRO, COMFORT, SPORT and SPORT+ modes; each activates different settings for extra sporty, more relaxed or maximized fuel-efficient driving modes.

Storage compartments are found throughout the cabin: in the front and rear doors, in a lidded compartment in the center console, an open compartment under the front and in the rear center armrests, in cupholders front and rear, in a storage tray, and in the glove compartment.

Anthracite headliner, exclusive to the Sport Line, M Sport and M Sport Package trims the A, B and C pillars, sunshades and grab bars in a sophisticated Black finish.



6-speed manual transmission delivers a precise, athletic feel. Its responsiveness is due, in part, to the enhanced synchronization of shifts from neutral to each gear. A shortened shift lever and "throw" add to the sporty feel of the gearbox. The sixth gear drops revs at highway speeds for smooth cruising.

8-speed STEPTRONIC automatic transmission with Adaptive Transmission Control (ATC) provides extremely fast synchronized shifting in either the Sport or Manual shift mode. By increasing the number of gears to eight, the transmission provides a more efficient shifting sequence and improved fuel economy.

8-speed Sport Automatic transmission provides extremely fast synchronized shifting. By increasing the number of gears to eight, the transmission provides a more efficient shifting sequence and improved fuel economy. Includes Adaptive Transmission Control (ATC) with Sport and Manual shift modes and steering wheel-mounted paddle shifters. When in Sport mode, shifts can be generated via the console-mounted shift lever or the paddle shifters.

Engine Start/Stop button controls the engine. After the electronic identification system recognizes and confirms the correct key code, you can start (or later, turn off) the engine by pressing the Start/Stop button. (Foot must be on the brake pedal in order to start.)

Automatic climate control system allows occupants to select a specific cabin temperature and choice of fan speeds, as well as automatic or manual airflow and recirculation. The automatic recirculation control activates whenever certain air pollutants are detected. The system also includes defrost/demist and MAX A/C functions.



Head-up Display projects important travel information, such as vehicle speed and Check Control warnings, onto the windshield directly in your field of vision. Data is shown in full color, making information even more precise and easier to process. Additional information, including Navigation directional arrows and instructions, can also be displayed.

FarmaSOS.com



Lane Departure Warning,¹ a component of Active Driving Assistant, uses a camera to recognize when your vehicle is crossing over lane markings or is changing lanes without signaling, and warns you by sending a mild vibration through the steering wheel. The system can be turned on and off via a button by the steering wheel.



Active Blind Spot Detection warns if a vehicle is in your blind spot, or if a vehicle is approaching at high speed in the passing lane, by displaying a visual signal in the exterior mirror casing. The system also warns you by making the steering wheel vibrate should you then use the turn-signal indicator before executing a lane change.



Speed Limit Info detects local speed limit signs and shows them in the Info Display and Head-up Display.



Automatic-dimming interior and exterior mirrors sense the bright headlights of vehicles behind you and automatically darken. The exterior power-adjustable side-view mirrors include a fold-in function.

BMW Universal garage-door opener takes the place of up to three remote-control devices. It can activate remote functions outside the vehicle, such as garage-door openers or home-lighting systems.

¹ Requires clearly definable lane markings that are not obscured by rain, snow, etc. Lane Departure Warning feature is not a substitute for the driver's own responsibility in maintaining safe control of the vehicle.

Not all features available on every model. Get the latest information on BMW standard and optional features, packages and technical specifications. Visit bmwusa.com, select the BMW model of your choice, and click on "Features & Specs."

Equipment features and options.



Park Distance Control (PDC) uses ultrasonic sensors in the front and rear bumpers to help you judge the distance to other cars and unseen objects when parking. The beeping becomes faster as your bumper approaches the object, turning into a constant tone when the distance is less than 12 inches.



Surround View displays video images of approaching traffic on the Control Display. Side-view Cameras positioned in the front bumpers show traffic approaching the front of the vehicle from the sides, such as when exiting a garage. The Top-view Camera provides video images of the road alongside the doors, taken by cameras positioned in the exterior mirrors.



Integrated Owner's Manual provides immediate access to all vehicle-specific information. This digital version of the traditional printed manual that is included with your BMW can be accessed via the iDrive and is shown on the Control Display. The system's user-friendly features include multi-media elements such as animations and dynamic illustrations.

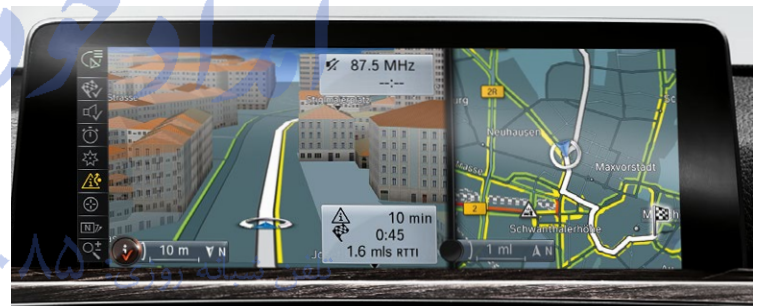

BMW's iDrive 4.2 **Navigation system** uses Global Positioning System (GPS) satellites and data stored on an internal hard drive to guide you to your destination, which is displayed on a high-resolution screen. The 200 GB hard-drive-based system features include 3-D daytime and nighttime maps, zoom and satellite images, travel planner, and an Assistance Window. It also offers Voice command for convenient, hands-free operation, and 20 GB of storage for your favorite media files. The available BMW Online option includes MyInfo, which allows Google Maps™ destinations to be sent to your vehicle.



SiriusXM® Satellite Radio delivers over 140 channels of the most innovative satellite radio music, news, sports, talk, comedy and entertainment. All music channels are commercial-free, delivered coast-to-coast in crystal-clear digital sound, 24 hours a day. Sign up for the Sirius Premier package and you can enjoy even more programming, including every MLB® game, Oprah Radio®, NHL® and NBA games, Opie & Anthony, Bob Edwards and more.



BMW anti-theft AM/FM stereo CD/MP3 audio system offers Radio Data System (RDS), Auto-Store, and 3-channel FM diversity antenna system. Song titles are displayed on the 6.5-inch color monitor (shown), or on the 8.8-inch color monitor included in the BMW ActiveHybrid 3 or in vehicles equipped with the Navigation system.



Harman Kardon® Surround Sound System is a 16-speaker, multi-channel system that outputs reproduction of the surround information contained in the stereo signal in a nine-channel format as well as 5.1 surround sound from a DVD source. Includes a powerful 600-watt digital amplifier with nine channels. The system compensates for driving noise in smooth steps with speed-dependent equalizing.



High-fidelity speaker system with 205-watt amplifier, vehicle-specific equalizing, and nine speakers for a colorful sound experience.

Not all features available on every model. Get the latest information on BMW standard and optional features, packages and technical specifications. Visit bmwusa.com, select the BMW model of your choice, and click on "Features & Specs."

Equipment features and options.



10-way adjustable front seats offer manual adjustment fore/aft, backrest angle, seat angle, seat height and two-way headrests with Active Head Restraints feature.

Ambiance lighting adds the drama of a warm reddish light that runs from front to rear beneath the inner door ledge. Ambiance lighting also includes soft on/off interior lights; reading lights; vanity mirror lighting; illumination in the front footwells, trunk, and storage compartments in the center console and doors; and illuminated door trims and entry sills with metal insets.



Front cupholders are conveniently integrated into the center console in front of the gear shift lever. A cover provides additional storage space and can be stored in the glove compartment to save space.

12-way power front sport seats make the driving experience more enjoyable with adjustments for fore/aft, seat height, backrest angle, seat angle and thigh support. Side bolsters can be power-adjusted to comfortably fit your back while helping to hold you firmly in place during cornering. Includes two-way headrests with Active Head Restraints feature.



Lumbar support for front seats adds four-way adjustable comfort for the lower back. Lumbar support can be adjusted up/down and in/out.



Heated front seats are a welcome feature in cooler weather. By pressing the icon button, the seating surfaces – seat bottom, backrest and sides – are heated to your choice of three settings. **Heated rear seats** offer multiple settings to warm the seat bottoms and backrests of the left and right seats.



Power seat adjustment for driver and front passenger customizes seat height, seat and backrest angle, and fore/aft position. Includes a two-driver memory function for driver's seat and power-folding exterior mirrors.



Power sunshade for the rear window can be raised and lowered at the press of a button. Together with manual sunshades for the rear side windows, this feature maintains occupant privacy, helps eliminate glare, and helps lower the cabin temperature by reflecting intense sunlight. (European model shown.)

FarmaSOS.com



Rear fold-down seats allow flexible combinations of passengers and cargo. Use the folding 40/20/40 seats with through-loading feature for transporting skis or other long items.



Rear center armrest includes two cupholders integrated into the front of the armrest. When not in use, they can be stored out of sight by sliding them back into the armrest. The armrest swings up to create a third rear-passenger seat.

Original BMW Accessories.



Add to the sporty look with the **BMW Roof Box 460 in Black**, and **20-inch Double Spoke (Style 361) black light alloy wheels with a red accent ring**.



Backrest bag allows passengers to bring and store travel necessities. Coordinates with Sport Line interior.



Ski and snowboard bag securely holds snowboards or skis and poles; complements the Sport Line design.



Snap-in Adapter with USB interface plays stored music, charges the mobile phone and accesses the car antenna.



Handbrake lever handle is specially designed to enhance the Sport Line interior.



Velour floor mats with heel pad are a precise fit, dirt-repellent, and water-resistant. Available in different colors.

Driving a BMW is always a special experience. Enhance it further with the wide range of Original BMW Accessories: exterior, interior, mobile communications, transportation and storage.

Choosing a BMW also shows you value dynamic driving, innovative technology and sporty style. Now you can express your passion to the ultimate degree with the BMW Performance line. BMW designers took their inspiration from BMW M – the heart and soul of BMW motorsport – to create this collection of track-bred accessories. From aerodynamic components to carbon-fiber trims, high-performance chassis enhancements to M-style interior appointments, these accessories allow you to individualize the look and performance of your BMW. For more information on Original BMW Accessories and the BMW Performance line, visit us online or see your preferred authorized BMW center.

➔ shopbmwusa.com

BUILD YOUR OWN BMW – AT BMWUSA.COM/BYO.



At BMW, we want you to create your own Ultimate Driving Machine.® That's why BMW offers one of the widest model ranges of any luxury automotive manufacturer. And each BMW model offers its own universe of personalizing possibilities.

It's easy to get the latest information on your favorite BMW model, whether you're at your desk or on the go. Visit bmwusa.com on your computer, tablet or smartphone, and click on the BMW model of your choice. Select **"Features & Specs"** to see all the standard features and available options and packages, as well as technical specifications.

You can then create the exact BMW model that fulfills your needs by clicking on **"Build Your Own"** – or visiting bmwusa.com/byo. Here you'll be able to select from among the many interior and exterior colors and trims, personalizing options and value-added packages. Build a BMW model that reflects your style, then view it in 360° detail. At the press of a button, see payment and financing options, get a same-day quote, download a product brochure and even schedule a test drive. BMW makes it easier than ever to make your ultimate driving dreams come true, at bmwusa.com.

		320i	320i xDrive	328i	328i xDrive	328d	328d xDrive	335i	335i xDrive	ActiveHybrid 3
--	--	-------------	--------------------	-------------	--------------------	-------------	--------------------	-------------	--------------------	-----------------------

Weight										
Unladen	lbs	(3250) 3295	3450	(3360) 3410	3595	3460	3620	(3545) 3555	(3695) 3710	3825
Weight distribution, front/rear										
Manual transmission	%	49.5/50.5	—	49.4/50.6	—	—	—	51.1/48.9	52.2/47.8	—
Automatic transmission	%	50.1/49.9	51.9/48.1	50.0/50.0	51.3/48.7	49.1/50.9	50.8/49.2	51.5/48.5	52.6/47.4	49.9/50.1

Engine										
Type/cylinders/ valves per cylinder		TwinPower Turbo/ Inline 4/4	TwinPower Turbo/ Inline 4/4	TwinPower Turbo/ Inline 4/4	TwinPower Turbo/ Inline 4/4	Variable Geometry Turbo/ Inline 4/4	Variable Geometry Turbo/ Inline 4/4	TwinPower Turbo/ Inline 6/4	TwinPower Turbo/ Inline 6/4	TwinPower Turbo/ Inline 6/4
Displacement	cc	1997	1997	1997	1997	1995	1995	2979	2979	2979
Bore/stroke	inch	3.3/3.5	3.3/3.5	3.3/3.5	3.3/3.5	3.3/3.5	3.3/3.5	3.3/3.5	3.3/3.5	3.3/3.5
Nominal output/rpm	hp	180 / 5000-6250	180 / 5000-6250	240 / 5000-6000	240 / 5000-6000	180 / 4000	180 / 4000	300 / 5800-6000	300 / 5800-6000	335 / 5800-6000
Maximum torque/rpm	lb-ft	200 / 1250-4500	200 / 1250-4500	255 / 1250-4800	255 / 1250-4800	280 / 1750-2750	280 / 1750-2750	300 / 1300-5000	300 / 1300-5000	330 / 1300-5000
Compression ratio	:1	10.0	11.0	10.0	10.0	16.5	16.5	10.2	10.2	10.2
Fuel tank capacity	gal	15.8	15.8	15.8	15.8	15.0	15.0	15.8	15.8	15.0
Fuel grade		unleaded premium gasoline	unleaded premium gasoline	unleaded premium gasoline	unleaded premium gasoline	diesel	diesel	unleaded premium gasoline	unleaded premium gasoline	unleaded premium gasoline

Transmission										
Gear ratios – 6-speed manual										
I/II/III	:1	3.50/2.01/1.31	—	3.68/2.06/1.31	—	—	—	4.11/2.32/1.54	4.11/2.32/1.54	—
IV/V/VI/R	:1	1.00/0.81/0.70/3.19	—	1.00/0.81/0.68/3.35	—	—	—	1.18/1.00/0.85/3.73	1.18/1.00/0.85/3.73	—
Final drive ratio	:1	3.08	—	3.91	—	—	—	3.23	3.23	—
Gear ratios – 8-speed automatic										
I/II/III	:1	4.71/3.14/2.11	4.71/3.14/2.11	4.71/3.14/2.11	4.71/3.14/2.11	4.71/3.14/2.11	4.71/3.14/2.11	4.71/3.14/2.11	4.71/3.14/2.11	4.71/3.14/2.11
IV/V/VI	:1	1.67/1.29/1.00	1.67/1.29/1.00	1.67/1.29/1.00	1.67/1.29/1.00	1.67/1.29/1.00	1.67/1.29/1.00	1.67/1.29/1.00	1.67/1.29/1.00	1.67/1.29/1.00
VII/VIII/R	:1	0.84/0.67/3.30	0.84/0.67/3.30	0.84/0.67/3.30	0.84/0.67/3.30	0.84/0.67/3.30	0.84/0.67/3.30	0.84/0.67/3.30	0.84/0.67/3.30	0.84/0.67/3.32
Final drive ratio	:1	3.15	3.39	3.15	3.15	2.81	2.81	3.15	3.15	2.81

Performance										
Acceleration 0-60 mph ¹										
Manual transmission	sec	7.1	—	5.7	—	—	—	5.4	5.1	—
Automatic transmission	sec	7.1	7.1	5.8	5.7	7.4	7.3	5.1	4.8	5.2
Top speed ²	mph	130 [146]	130 [143]	130 [155]	130 [149]	130 [143]	130 [142]	130 [155]	130 [(149) 155]	130 [155]

Figures in () apply to vehicles with 6-speed manual transmission, if different.
 Figures in [] apply to vehicles with performance tires and increased top-speed limiter.

¹ BMW AG test results. Figures for 320i and 320i xDrive are preliminary. Actual acceleration results may vary, depending on specification of vehicle; road and environmental conditions; testing procedures and driving style. These results should be used for comparison only and verification should not be attempted on public roads. BMW urges you to obey all posted speed laws and always wear safety belts.

² Top speed limited electronically.

³ EPA-estimated figures are for comparison purposes only. Your actual mileage will vary, depending on speed, driving habits, trip length and driving conditions; actual mileage may be lower. Preliminary figures shown are subject to revision.

⁴ xDrive models: 56.5 inches.

⁵ 335i, 335i xDrive and ActiveHybrid 3: 60.5 inches.

⁶ 320i xDrive, 328i xDrive, 328d and 328d xDrive: 61.8 inches; 335i, 335i xDrive and ActiveHybrid 3: 62.1 inches.

		320i	320i xDrive	328i	328i xDrive	328d	328d xDrive	335i	335i xDrive	ActiveHybrid 3
--	--	-------------	--------------------	-------------	--------------------	-------------	--------------------	-------------	--------------------	-----------------------

Fuel consumption ³										
Manual transmission – City/Highway	mpg	23/36	—	22/34	—	—	—	20/30	20/28	—
Automatic transmission – City/Highway	mpg	24/36	23/35	23/35	22/33	32/45	31/43	22/32	20/30	25/33

Tires and wheels										
Tire dimensions		225/50	225/50	225/50	225/50	225/50	225/50	225/45	225/45	225/45
Wheel dimensions		17 x 7.5	17 x 7.5	17 x 7.5	17 x 7.5	17 x 7.5	17 x 7.5	18 x 8.0	18 x 8.0	18 x 8.0
Material		light alloy	light alloy	light alloy	light alloy	light alloy	light alloy	light alloy	light alloy	light alloy

Electrical										
Battery / Battery position	Ah	90 /luggage compartment	90 /luggage compartment	90 /luggage compartment	90 /luggage compartment	90 /luggage compartment	90 /luggage compartment	90 /luggage compartment	90 /luggage compartment	90 /luggage compartment
Alternator	A /W	170/2380	170/2380	170/2380	210/2940	180/2520	180/2520	210/2940	210/2940	200/2800

BMW 3 Series Sedan

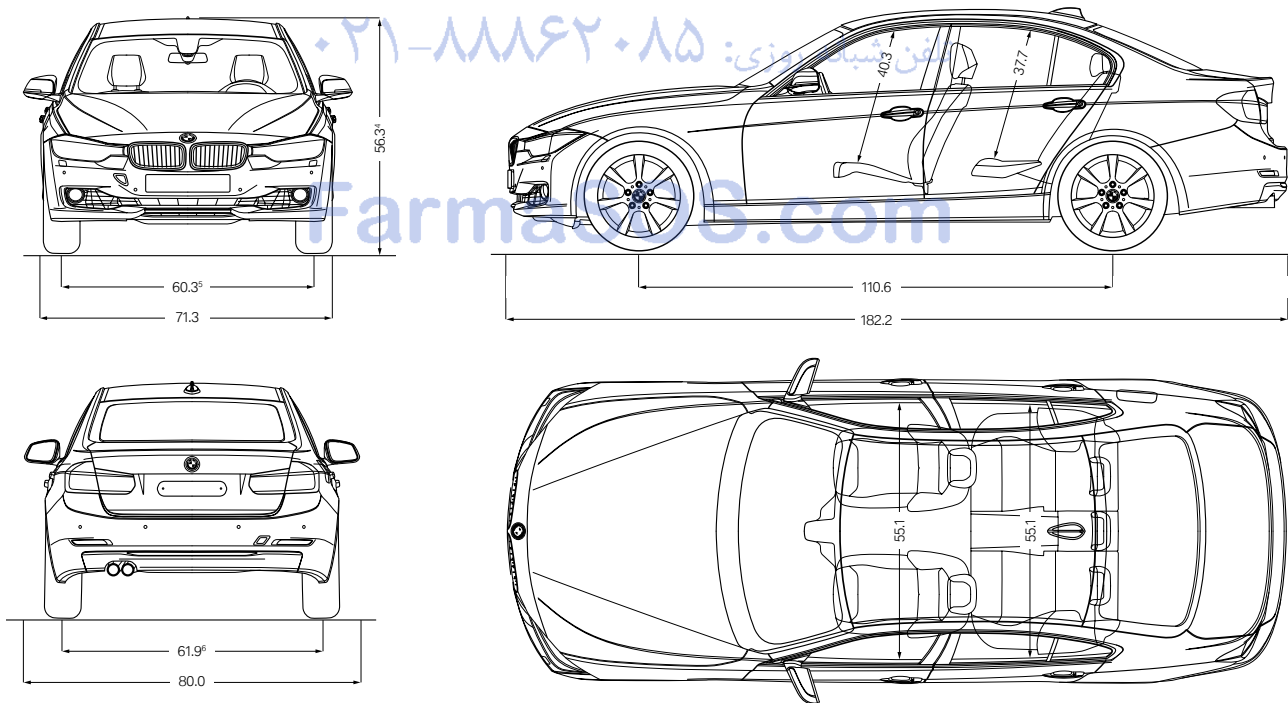

All dimensions in the technical drawings are shown, in inches, for 328i; dimensions for other models, if different, are footnoted.

U.S. Importer: BMW of North America, LLC, Woodcliff Lake, NJ 07677. All illustrations and specifications contained in this brochure are based on the latest product information available at the time of printing. BMW reserves the right to make changes at any time, without notice, in colors, materials, equipment, specifications, design and models. BMW may, subject to legal requirements, determine the Model Year designation of its vehicles. The Model Year designation on any particular model may be longer or shorter than 12 months. Some vehicles pictured may contain non-U.S. equipment. Some models may be shown with optional equipment. While BMW NA makes all reasonable efforts to provide accurate information in this brochure, there is no guarantee or warranty of accuracy. Furthermore, we do not assume any liability for the accuracy or completeness of information presented. This brochure shall not be used or relied upon as a substitute for information that is available from your authorized BMW center. Further information can be obtained from your authorized BMW center or bmwusa.com.

©2014 BMW of North America, LLC. Not to be reproduced wholly or in part without written permission of BMW NA. The BMW name, logo, model names and SAV are registered trademarks. The Bluetooth word mark and logos are owned by the Bluetooth SIG, Inc. and any use of such marks by BMW is under license. iPhone, iPod and iPad are registered trademarks of Apple Inc. Other trademarks and trade names are the property of their respective owners.

We believe that a premium ownership experience should feature performance and luxury, as well as safety and convenience. We believe you should be able to drive a BMW to its potential, while enjoying peace of mind and reduced cost of ownership. That's the idea behind **BMW Ultimate Service**[®]: a suite of comprehensive programs and services that are included in every new BMW vehicle. It starts with the **New Vehicle/SAV Limited Warranty**,¹ providing you with coverage for the first four years or 50,000 miles, whichever comes first. Additionally, you enjoy 12-year, unlimited-mileage warranty protection against corrosion and rust

performance.¹ BMW Ultimate Service continues with **BMW Maintenance Program** for the first four years or 50,000 miles,² **BMW Roadside Assistance**, and more. The BMW 3 Series Sedan also comes with a broad range of BMW ConnectedDrive[®] services including **BMW Assist eCall**,^{TM3} **BMW TeleService**,³ **BMW Online**⁴ and **Remote Services**.³ **Concierge Services** with **Critical Calling**⁵ is available on 328i, 328d and 335i rear-wheel-drive and xDrive models, as well as on the ActiveHybrid 3.

GOING BEYOND ENGINEERING: THE HIGH-PERFORMANCE BMW OWNERSHIP EXPERIENCE.



BMW Maintenance Program is one of the most comprehensive maintenance programs in its class. We cover all factory-recommended maintenance during the New Vehicle/SAV Limited Warranty coverage period. This includes scheduled oil services and inspections. Also covered is the replacement of items that are subject to normal wear and tear, such as brake pads, wiper blade inserts and engine drive belts.² And, thanks to BMW's advanced engineering, most owners enjoy a well-balanced maintenance schedule, with flexible routine service intervals that can save you time. When your vehicle requires attention, your authorized BMW center ensures that it receives only genuine BMW parts – your assurance of exacting quality standards.

For more details on BMW Ultimate Service and the BMW Maintenance Program, visit your authorized BMW center or log on to bmwusa.com/ultimateservice.



BMW Assist eCall,³ a safety feature of BMW ConnectedDrive, lets you enjoy peace of mind knowing that a friendly response specialist is there to help you, 24/7, at just the push of a button. This includes Emergency Request (SOS button), Automatic Collision Notification, and Customer Relations. **BMW TeleService**³ continually monitors specific vehicle parts that are subject to wear and tear, as well as services that require attention at regular intervals, such as vehicle service inspections. This data is automatically transmitted to your authorized BMW center, which informs a BMW Service Advisor to call and schedule a convenient service appointment. You don't have to keep track of when your vehicle requires routine maintenance. An added benefit: any needed maintenance service parts will already be on hand, so your BMW is serviced and returned to you as quickly as possible. And because they use only Original BMW Parts, you can rely on expert fit and long-lasting BMW quality.



BMW Roadside Assistance is provided free of charge for the first four years – with no mileage limit. Call **1-800-332-4BMW (4269)** for friendly on-the-road help, 24/7, anywhere in the United States, Canada and Puerto Rico. This includes everything from flat-tire changes, emergency gasoline and lock-out service, to towing, alternative transportation and even trip-interruption benefits. This service also provides valuable trip-routing advice.

BMW Online⁴ provides up-to-date web information: business and stock reports, as well as weather updates. BMW Online also includes **MyInfo**, which allows you to send business locations and street addresses with their associated phone numbers from the Google MapsTM website directly to your BMW. The destination can be sent to your Navigation system for turn-by-turn directions.

Enhanced USB and Bluetooth[®] with Smartphone Integration offers an array of Mobile Office⁵ functions. With the BMW Navigation system and your mobile phone linked via Bluetooth technology, Mobile

Office transfers text messages and emails to your iDrive Display screen and then reads them aloud to you. While en route, a calendar and to-do list can also appear on your Display screen. Running late? Click on the phone number in the calendar to call your appointment. For a list of tested mobile phones, visit bmwusa.com/bluetooth.

Remote Services³ includes Remote Door Unlock, Stolen Vehicle Recovery, and access to the My BMW Remote app, which allows you to control your BMW from your mobile device.

For the ultimate in coverage, there's **Concierge Services**.⁵ You'll enjoy unlimited access to personalized Directions and services for restaurant and hotel recommendations, with the destination address and phone number not only sent right to your BMW, but also transferred to your Navigation system for route guidance. Another useful Concierge feature: **Critical Calling**. This lets you make up to four operator-assisted calls per year, up to five minutes per call, if your mobile phone is not available, or if its battery is discharged.



THE MOST EXCITING PLACE IN AMERICA TO DRIVE THE 3 SERIES SEDAN.

The BMW Performance Center in Spartanburg, SC.

Just beyond the foothills of the Carolinas' Blue Ridge Mountains lies the \$12 million BMW Performance Center. This sprawling, modern complex houses the world-famous BMW Performance Driving School, as well as the Zentrum Museum, BMW Boutique, BMW Delivery Center, and a Corporate Conference Center. Nearby is BMW's only manufacturing facility in the U.S., where models, such as the SAV,[®] are built for export worldwide. It's a unique place where BMW enthusiasts can spend days – or, in the surrounding area, an entire vacation.



EXPERIENCE MORE WITH BMW.



BMW Financial Services. Arranging to buy or lease a BMW is easier than you may think. Your authorized BMW center offers leasing and financing to suit your personal needs through BMW Financial Services.⁷ Start the process at our website, where you can build your “dream vehicle,” get an estimate on a monthly lease or financing payment, submit a credit application to BMW Financial Services – and get approval – all online!⁷ To find out how BMW Financial Services can help put you behind the wheel of your favorite BMW model, log on to bmwusa.com/fs or call, toll-free, **1-800-578-5000**.



BMW Virtual Center. If you get the sudden urge to shop for a BMW but your authorized BMW center is closed, there's good news – the BMW Virtual Center is open 24 hours a day! Log on to bmwusa.com/byo, and choose the model that interests you. Configure the BMW of your dreams, and see what the monthly payments would be. You can even send the specifications to your authorized BMW center, apply for financing, or request a test drive – all online!



BMW Magazine. A fascinating view of the latest events and products in the world of BMW, including travel reviews, personality profiles, and the latest BMW technologies. **BMW Magazine** is sent to new owners and lessees twice a year.



BMW Performance Driving School. Take your driving skills to the next level. Behind the wheel of new BMWs and under the guidance of professional instructors, you'll hone your driving skills on a 1.7-mile driving course that can be configured in a multitude of ways. In One- and Two-Day Schools you can tackle the skid pad, slalom course and water walls. The BMW Performance Driving School is about control and pushing a BMW to its limits – and yours. Visit bmwusa.com/pds.

Performance Center Delivery. You'll always remember the fun of taking delivery of your new BMW – especially with BMW Performance Center Delivery in Spartanburg, SC. After enjoying dinner and an overnight stay at a first-class hotel, we'll take you and your companion to the Performance Center where a Product Specialist will give you an in-depth introduction to your new BMW. Then at the Performance Driving School, you'll get tips from a professional driving instructor as you explore the dynamic capabilities of a similar model. It's exciting, it's enlightening – and it's all compliments of BMW with your new vehicle. To learn

more about the BMW Performance Center, call **1-888-345-4269** or visit bmwusa.com/pdsdelivery.

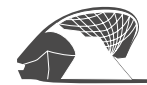

The **BMW Welt** (“BMW World”) delivery and brand-experience center in Munich is bold proof of BMW's passion for design. When you take advantage of the BMW European Delivery Program,⁸ this is where you will meet your new BMW – in a personalized process that is highly dramatic and totally unforgettable. (You might also realize substantial savings that just may pay for your trip.) While you're there, marvel at the historic BMWs in the Museum; learn about our engineers' newest innovations in the Technology and Design Atelier; and take a tour of the plant to experience firsthand the state-of-the-art methods used to create a BMW. Then comes the unique experience of driving your new BMW on the roads it was designed for. To learn more, visit bmwusa.com/europeandelivery.

¹ See your authorized BMW center for details on these limited warranties.

² The BMW Maintenance Program covers factory-recommended maintenance services as determined by the Service Interval Indicator for all new eligible MY 2004 and later BMW vehicles. Specific additional items that need replacement due to normal wear and tear are also covered. Every new BMW is covered by a limited warranty for defects in materials or workmanship for the first four years or 50,000 miles, whichever comes first. The warranty period begins either on the date of first retail sale, or the date the vehicle is first placed in service as a demonstrator, service loaner or company vehicle, whichever is earlier. And from that moment on, your BMW is protected during the coverage period, regardless of whether you're the first or a subsequent owner. Exclusions from coverage include: gasoline, gasoline additives, windshield washer fluid and additives, battery, tires, wheels, wheel alignment and tire balancing. All work must be performed by an authorized BMW center. See the Service and Warranty Information booklet for specific terms, conditions and limitations. Further information can also be obtained from your authorized BMW center.

³ On 2014 and later BMW 3 Series Sedan models, BMW Assist eCall and BMW TeleService are optional on ActiveHybrid 3 and standard on all other models; 10 years of service are included. Remote Services, which comes with the optional Navigation system, also includes 10 years of service. In order to receive these services, a subscriber agreement must be completed and transferred to the BMW Assist™ Response Center. GPS and underlying wireless services must be available and functioning, vehicle ignition must be turned on (except for Remote Services), battery must be charged and connected, and vehicle's electrical system operational. Due to wireless carrier coverage, services may be limited in certain geographic areas. Call toll-free **1-888-333-6118**, go to bmwassist.com, or visit your authorized BMW center for additional program details. Services are subject to the terms and conditions of your subscriber agreement.

⁴ BMW Online, which comes with the optional Navigation system, includes a 3-year subscription. Subject to the terms and conditions of your subscriber agreement. Please go to bmwusa.com/connecteddrive for additional details.

⁵ Concierge Services is optional and includes a 3-year subscription; not available on 320i or 320i xDrive.

⁶ Not all mobile phones are compatible with Mobile Office, and some compatible phones support a limited number of Mobile Office functions. For the complete list of compatible mobile phones and the details regarding which Mobile Office functions are supported by each phone, please visit bmwusa.com/bluetooth.

⁷ Subject to credit approval and other terms and conditions.

⁸ Not all models are available for BMW European Delivery Program. Please go to bmwusa.com/europeandelivery or visit your authorized BMW center for details.

More about BMW

bmwusa.com
1-800-334-4BMW



The Ultimate
Driving Machine®

امداد خودرو فارما

تلفن شبکه روزی: ۰۲۱-۸۸۸۶۲۰۸۵

FarmaSOS.com

BMW and the environment.

BMW is a strong proponent of the environment and social responsibility. We launched BMW EfficientDynamics back in 2000 – the philosophy of providing greater power with increased efficiency and fewer emissions. This has resulted in significant benefits today – for our customers, the climate and the environment.

That year, ecological sustainability was also declared one of BMW's core strategic principles; it is now firmly anchored in our entire production chain. It starts with the development of fuel-saving and alternative vehicle concepts, continues with environmentally friendly production processes, and ends with innovative recycling methods. This effort has been recognized worldwide; in 1999, BMW AG – the parent company of BMW of North America and BMW Manufacturing Co. in Spartanburg, SC – was the first automotive company to be represented on the Dow Jones Sustainability Group Index. It has remained on the Index ever since; moreover, since 2005, BMW has been voted the world's most sustainable automobile manufacturer. At BMW, we strive for and achieve high performance in all we do.

BMW recommends  **EDGE**