

The all-new  
2011 BMW  
5 Series Sedan



The Ultimate  
Driving Machine®

528i  
535i  
550i

امداد خودرو فارس  
021-84570800  
Farma.com



# THE ALL-NEW 5 SERIES SEDAN.

JOY IS AN EXPLORATION OF BEAUTY.

**BMW EfficientDynamics**  
Less emissions. More driving pleasure.



امداد خودرو فارما

تلفن: ۰۲۱-۶۲۰۸۵۰۸۵

FarmaSOS.com



**POWERED BY CREATIVITY.  
INSPIRED BY JOY.**

The all-new BMW 5 Series Sedan: the perfect symbiosis of modern design and driving pleasure. It's our tribute to the beauty of ideas – the lifeblood of our company. Whether in the grand sweep of an eye-catching contour, or in the rigid, lightweight construction of the suspension, innovative ideas keep every inch of the BMW 5 Series Sedan moving forward. And with over 90 years of creating vehicles designed to stay at the forefront of the industry, we know a thing or two about the beauty and joy of driving.



## The all-new BMW 5 Series Sedan

### AESTHETIC MEETS ATHLETIC.

- 06 Exterior**  
The shape of perfection.
- 10 Driving experience**  
Highlights of the all-new BMW 5 Series Sedan.
- 20 Dynamics and design**  
Interview with chief designer Adrian van Hooydonk.
- 22 Interior**  
Cockpit and rear-cabin highlights.
- 26 Experience**  
Five minutes in the all-new BMW 5 Series Sedan.

[bmwusa.com/allnew5](http://bmwusa.com/allnew5)

## Technology

### NEW REVELATIONS ON REVOLUTIONS.

- 28 Performance**  
The BMW 5 Series Sedan on the move.
- 30 BMW EfficientDynamics**  
Technology that increases driving joy while reducing fuel consumption and emissions.
- 32 Engines**  
A pair of TwinPower Turbo engines and one naturally aspirated powerplant.
- 34 Chassis and safety features**  
Innovations that bring joy.
- 36 Technology/BMW Assist™**  
Systems that add convenience and peace of mind while you're on the road.
- 40 Six technical questions**  
Explaining six interesting technologies in the all-new BMW 5 Series Sedan.

[bmwusa.com/technology](http://bmwusa.com/technology)

## Equipment

### ONE OF A KIND, ONE AT A TIME.

- 42 Combination examples**
- 44 Exterior colors**
- 45 Upholstery materials and colors**
- 46 Interior trims**
- 47 Recommended color combinations**
- 48 Standard/Optional equipment**
- 56 Original BMW Accessories**  
World-class, yet personalizing.

[bmwusa.com/byo](http://bmwusa.com/byo)

## Summaries

### BMW 5 SERIES SEDAN OVERVIEW.

- 58 Equipment charts**
- 64 Technical data**
- 66 BMW Services**  
Exclusive offers for BMW customers.

#### Equipment of model shown: BMW 535i Sedan

Engine:	24-valve BMW TwinPower Turbo 3.0-liter inline six-cylinder engine
Nominal output:	300 hp @ 5800 rpm
Wheels:	V Spoke (Style 531) 19" light alloy
Exterior color:	Space Gray Metallic
Upholstery:	Venetian Beige Dakota Leather
Interior trim:	Anthracite Wood
Optional equipment:	Sport Package, Premium Package, 8-speed Sport Automatic transmission, 4-zone climate control

For information on specifications please see pages 64-65.

## Editorial

# A MASTER CLASS IN MOTION.

The art of design.

BMW believes in the potency of ideas. From high-performance engines to advanced handling technologies, many of our greatest concepts begin at desks, on printouts or in blueprints. But an idea doesn't have to start on paper to be powerful – or inspiring.

At the BMW Museum in Munich, there is a kinetic sculpture that immediately catches the eye with its complexity and beauty. No less than 714 metal balls continually align and then realign themselves in ever-shifting patterns – some abstract, some in the familiar contours of a BMW vehicle. The sculpture serves as a perfect representation of our approach to design: it is this same fluid concept of beauty that we apply to our vehicles, even from the earliest stages. And like the sculpture, each component of our design concept must be in place in order to create a cohesive, unified whole. Like a team of artists, our designers work together to shape their vision using models, sketches and even discussions. It's a complex process that yields a truly unique product: a new BMW design.

The all-new 5 Series Sedan – a winning combination of elegance, sportiness and luxury – captures this principle beautifully. With its timeless profile with contours that impress, the gracefully chiseled body of the 5 Series Sedan expresses the essence of BMW design. But it is not simply a superficial attraction. You'll find equal attention to detail has been paid to the entire vehicle. The cabin serves as a master class in functional comfort, from the Black Panel Display technology that awakens to glowing life at the press of the Start button, to the new Parking Assistant feature that selects and then helps pilot you into parking spaces. Under the hood, BMW's TwinPower Turbo engines have become more fuel efficient, giving you even more reasons to keep driving longer. Each of these aspects is compelling on its own. Incorporated into a single, symphonic whole, the result is no less than class-leading. The 5 Series Sedan resets the standards. It's a difference that rewards drivers, passengers and onlookers alike.

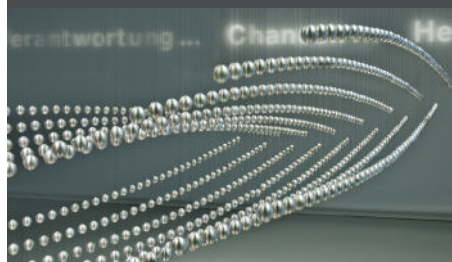

# AESTHETICS

The design and style of the 5 Series Sedan answers any questions about how we see the world of automotive beauty. From the powerful front end, to the expressive contours, to the signature Hofmeister kink, each eye-catching section is also a vital component in the dynamic, elegant symphony of the vehicle's exterior. And if your question is, does it drive the way it looks? The answer is a resounding yes.





امداد خودرو فاریا

تلفن: ۰۲۱-۸۸۶۲۰۸۵

FarmasOS.com

**THE PURSUIT OF  
HAPPINESS IS  
NEVER-ENDING.**

Elegance and efficiency, sophistication and swagger: the all-new BMW 5 Series Sedan gives drivers and passengers a sense of purpose on the road – and a reason to keep moving.



# JOY.



FarmaSOS.com

## BMW EFFICIENT DYNAMICS: THE LANGUAGE OF BMW ENGINEERING.

BMW EfficientDynamics has kept us moving toward one constant goal: our unwavering commitment to achieving maximum power and efficiency with minimum emissions. This compels us to create the most efficient models possible – from powerful, lightweight engines to aerodynamic tail ends, and every part in between. For example, our Brake Energy Regeneration technology harnesses the kinetic energy normally wasted when coasting and stopping. This energy is stored in the vehicle's battery, where it is available for running electrical components. As a result, the engine does less work, saving fuel and reducing emissions. It's just one more way BMW is moving forward to make driving as enjoyable and efficient as possible.

[bmwusa.com/efficientdynamics](http://bmwusa.com/efficientdynamics)





In crafting a perfectly balanced model of power, the engine is at the heart of the issue. With no fewer than three engine choices, the all-new 5 Series Sedan offers classic pulse-raising BMW performance – including, in the 550i, a stunning 4.4-liter, 400-hp TwinPower Turbo V-8 engine with High Precision Direct Injection. In the 535i and 550i, a 6-speed manual and two new 8-speed automatic transmissions not only harness this power perfectly, they also enhance fuel efficiency. It's the most thrilling way to take flight in our latest masterpiece.



اراد خودرو فارما

تلفن شنبانه روزی: ۰۲۱-۸۸۸۶۲۰۸۵

FarmaSOS.com

**OUR DREAMS MOVE US.  
THEY'LL MOVE YOU, TOO.**

For details on the availability of standard and optional features, please refer to the Equipment charts at the back of this brochure.



BMW Driving Assistance technologies give important feedback on your vehicle's operating status and surrounding traffic. However, what you'll discover is their ability to reduce stress, making any time spent behind the wheel more enjoyable.

#### Head-up Display.

Key information is projected directly into your field of vision so you can focus on the road ahead while staying informed of your speed and operating data. If so equipped, view Navigation directions and Active Cruise Control data; and see BMW Night Vision with Pedestrian Detection and Lane Departure Warning System alerts.

#### Active Cruise Control<sup>1</sup> with Stop & Go function.

This feature uses radar measurements to automatically maintain a preset speed and distance between your vehicle and the one ahead in heavy traffic and highway driving. It can even bring your BMW to a stop, if needed. Once traffic allows, your BMW automatically returns to its preset speed. At all times, the Forward Collision Warning feature sounds an alert if you are approaching the vehicle ahead too quickly.

#### Lane Departure Warning<sup>2</sup> and Active Blind Spot Detection.

If your vehicle crosses the lane markings without first using the directional signal, the Lane Departure Warning System gently vibrates the steering wheel, alerting you. When the turn signal is activated, Active Blind Spot Detection monitors for vehicles in your blind spot or approaching at a higher speed in the passing lane. Should this be the case, the system alerts you by sending a mild vibration through the steering wheel and displaying a visible signal in the side-view mirror.



ایران خودرو فارما  
تلفن شبانه روزی: ۰۲۱-۸۸۸۶۲۰۸۵  
FarmaSOS.com

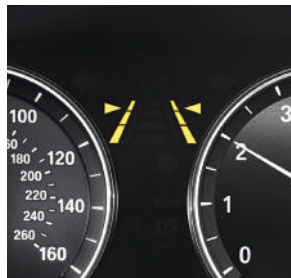
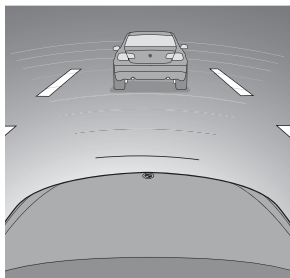
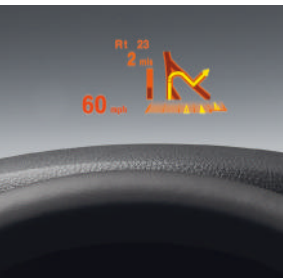

## TECHNOLOGY AT YOUR SERVICE: ADVANCED DRIVING ASSISTANCE SYSTEMS.

<sup>1</sup> Cruise Control is not a substitute for the driver's own responsibility in adjusting speed and otherwise controlling the vehicle. After evaluating the road, traffic and visibility conditions, the driver must decide whether and how the system is used.

<sup>2</sup> Requires clearly definable lane markings that are not obscured by rain, snow, etc. Lane Departure Warning feature is not a substitute for the driver's own responsibility in maintaining safe control of the vehicle.



Bold artistic statements must be reinforced in even the smallest details. In this case, numerous supporting technologies help you make the most out of every ounce of this masterpiece's power and grace. Take, for example, BMW's Electric Power Steering (EPS), making its debut in the all-new 5 Series Sedan. Enhancing both precision and comfort, the EPS system relies on an electric motor, as opposed to conventional mechanical systems, to provide assistance during steering maneuvers on an as-needed basis only. Once steering wheel movement ceases, such as cruising, energy consumption from this innovative system is reduced to zero. So you can drive exactly as you intended – with poise and precision.

# A BMW SHOULD ALWAYS RADIATE DYNAMISM.

Adrian van Hooydonk, 45, Head of BMW Group Design, invited us to join him on an exclusive test drive. An interview with the expert about the design of the all-new BMW 5 Series Sedan.

Interview: Jan-Kirsten Biener  
Captions: Brian Finally



Exterior designer Jacek Fröhlich gets to work on his design model.



Adrian van Hooydonk, Head of BMW Group Design, introduces the all-new BMW 5 Series Sedan.

FarmaSOS.com

**Adrian van Hooydonk, what do you personally find so special about the all-new BMW 5 Series Sedan?** This new BMW 5 Series reveals at a glance exactly what you can expect to experience inside. It's the perfect fit, like a suit that's made to order – and the BMW 5 Series suits any occasion. No matter if you're on business, on vacation or driving around town, you're always dressed right, with a sure sense of style.

**At BMW, the 5 Series invariably has a special part to play. How do you see the role of this series in the current BMW portfolio?** The 5 Series is the brand's core product. The BMW 5 Series Sedan has the longest pedigree in the range and, for that reason alone, it holds a special place in our corporate history. As always, this BMW 5 Series demonstrates the perfect combination of sportiness and elegance.

**Were these the two primary characteristics you were after in your design?** Let's say that's why the design of the new BMW 5 Series features very dynamic lines at the front and rear, while the side view has a stretched and timeless look to it.

**The way we see it, you've implemented three design concepts in a single car. Would you agree?** The observer always sees a car as a whole. Every BMW expresses a high degree of sportiness and elegance, with the mixture varying from one series to the next. For me, the BMW 5 Series is the epitome of the sporty business sedan. While it clearly belongs to the large sedan class, at the same time it has its own distinctive looks, based on the three primary characteristics that you referred to: the charismatic appeal of the front end, the stylish elegance of the side view, and the natural, authentic sportiness of the rear. Those were indeed the specifications for this model, and I'd say they're all readily identifiable in the finished product.

Interior designer Oliver Heilmer checking the lines and dimensions of the body on the clay model.

**You put great emphasis on the dynamism of this model. But how sporty can a BMW 5 Series Sedan be?** A BMW must always be an expression of dynamics and motion! The 5 Series in particular appeals to customers who love driving, including long distances, and really appreciate the typical driving dynamics of a BMW. The proportions are clearly defined by the heritage of BMW sedans: short overhangs, long wheelbase, a long hood and the cockpit set well back.

**It seems you like working with lines. The door handles, for example, meld into the seam lines. The primary measures of BMW's design language are proportion and volume. It's only at second glance that the lines that delineate the spaces become visible.**

**Inside, you've opted, in general, for clearly defined spaces, with clean lines and no unnecessary frills. What's the reasoning behind that?** The interior, too, has to speak of dynamics and elegance. Our idea was to express this through smoothly flowing lines across the instrument panel and doors.

**How do you manage to create an interior with such a modern atmosphere?** First and foremost, by ensuring that the exterior and interior form a harmonious whole – and just like on the outside, the closer you look inside the BMW 5 Series, the more innovations you discover. For example, there's the momentum of the two lines on the instrument panel that's carried over onto the passenger side – something that only strikes you at second glance. Or the way the trim panel transitions from the instrument panel to the door, with a chrome-color highlight. It's the sum of these detailed refinements that explains the appeal of the all-new BMW 5 Series interior.



**The headlights are capped with a strip of frosted glass that looks like an eyebrow, while the taillights have a pronounced L-shape. Why did you go for these visuals?** Our "night design," as we call it, ensures that the BMW 5 Series can be clearly identified as a BMW even in the dark. That's why, at the front, we chose to have the "eyebrows" lend a slightly angular look to the round twin headlights. The L-shape of the taillights builds a bridge between tradition and progress. The Corona headlight-rings are also available with state-of-the-art LED technology.

**Were there any areas where you deliberately wanted to set this model apart from its predecessor?** This time around, we have designed a very upright kidney grille. In fact, we've gone back to giving it a slight forward angle. This shows, on the one hand, how firmly rooted we are in our own design history. On the other hand, it underpins the sporty character of this model. Overall, the new BMW 5 Series Sedan looks a touch lower and wider than its predecessor – which means it looks even more dynamic.

**The kidney grille is particularly wide and striking in this model. Why is that?** Well, of course the kidney grille is not just a design element, it's also an important air inlet. But in the new BMW 5 Series the design of the kidney grille has one primary purpose. It says, "This is one sporty sedan!"

**Thank you very much for this exclusive interview! It was a pleasure talking to you.**



Emotional sketch of the exterior of the new BMW 5 Series Sedan.



BMW translated the luxurious comfort of the all-new 5 Series Sedan's interior to match the elegant joy of the exterior. Upon entering the cabin, it's clear that the vehicle's sweeping contours and clean lines have permeated the interior, as well. Choose from a wealth of sleek modern trims – like Dark Wood and Aluminum – as well as supple leather upholsteries, including BMW's optional plush Nappa Leather. Extensive Black Panel technology – both on the dash and in the center console – gives you easy-to-read information on everything from vital driving information, including speed and rpms, to climate control and Navigation system details; when not in use, the surface is simple, clean and dark. Speaking of controls, the driver-centric dashboard gives those behind the wheel quick and easy access to every knob, dial, wheel and button. Grasp the fourth-generation iDrive Controller and plot your course on a large, integrated 10.2-inch screen. And the new Top- and Side-view<sup>1</sup> Cameras provide visual assistance for parking and maneuvering in tight spaces, with images clearly transmitted to the iDrive screen. Intuitive, comfortable, and luxurious: the interior of the 5 Series Sedan is a truly stunning complement to the vehicle's sharp lines and good looks.

<sup>1</sup> Delayed availability.

For details on the availability of standard and optional features, please refer to the Equipment charts at the back of this brochure.

# PERFECTION.

WHERE FUNCTIONAL INTEGRATION MEETS  
PURE EXHILARATION.

## DISCOVER A PLACE WHERE EVEN SITTING DOWN INSPIRES AWE.



In typical BMW fashion, every surface and corner of the all-new 5 Series Sedan cabin is finished in premium materials. Sit back in seats upholstered in plush optional Nappa Leather. Run your eyes over the dash, accented with rich wood trims. You'll soon discover just how inviting and inspiring elegant design truly can be.



The all-new 5 Series Sedan delivers a rewarding rear-seat experience, even for tall passengers. Designed with ample headroom and greater knee-room than its predecessor, back-seat travelers are treated to more comfortable accommodations than ever before. Once they are settled in, four-zone automatic air conditioning provides individually adjustable air settings for the two outer seats. Passengers of all ages will appreciate the rear-seat entertainment system that offers two 8-inch monitors, plus a separate DVD drive and easy-to-use controls. And a premium hi-fi system puts the power of 16 high-end speakers at your disposal, for creating an atmosphere of acoustic bliss on any trip. Who says the driver's seat is the only great place in the 5 Series Sedan?

For details on the availability of standard and optional features, please refer to the Equipment charts at the back of this brochure.

# 5 MINUTES IN THE ALL- NEW BMW 5 SERIES SEDAN.

**Falling in love only takes 3 seconds.  
Forming a deep, lasting friendship  
takes 4 minutes and 57 seconds longer.**

What do the first five minutes in the all-new BMW 5 Series Sedan feel like? BMW researched the issue and documented the results. (The most important result was that the test subjects didn't really want to get out of the BMW 5 Series Sedan again.)

**2:47** It's so quiet, it's as if the world had been swaddled in a cotton blanket. Your senses become more acute. Everything in the cockpit, including the center console and gear selector lever, is focused toward you – the driver. Buttons can be reached with the tips of your fingers; just stretch out your hand.

**0:07** Operating the door handle is the first indication of things to come. The door opens with a satisfying sound that signals precise workmanship and first-class materials. You take your seat behind the steering wheel and look over the cockpit. Closing the door, you notice that it moves by itself the last couple of inches, then pulls itself shut, making barely a sound.

**1:12** The clear cockpit layout seems pleasantly familiar, with high-quality materials that make for a superb look and feel. You run your fingertips over the different types of surfaces. The leather-wrapped steering wheel feels sporty and compact. How good it is to the touch!

**3:31** Press the Start button, and the vehicle's functions come to life. The all-new BMW 5 Series Sedan talks to you in a wordless language. You twist, tilt and press the iDrive Controller, which functions with flawless precision. Everything is quick and easy to set up – like pairing your BMW-approved Bluetooth® mobile phone with the car.

**4:55** It's fun, getting to know the 5 Series Sedan interior. Exciting, too – like the first day at a job that you have been eagerly looking forward to. And then, the first press of the accelerator pedal. Still in neutral, you hear the power of the engine, feel its dynamic potential, can't wait to get going. And once you slide into gear, you know that you won't ever want to stop again.

For details on the availability of standard and optional features, please refer to the **Equipment charts** at the back of this brochure.

# AUTHENTICITY.



امداد خودرو فارس

www.farsad.com

**PUT YOUR HANDS  
ON THE WHEEL  
AND YOUR MIND  
AT EASE.**

Driven to innovate, BMW imbued the all-new 5 Series Sedan with a range of cutting-edge technologies that elevate the entire driving experience. But this is not technology for its own sake. Each groundbreaking feature is seamlessly designed and integrated for maximum operating efficiency and user-friendliness. Only in this way can we increase the thrill of The Ultimate Driving Machine® without losing its signature driving feel.

## BMW EFFICIENT DYNAMICS: GREEN – EVEN AT GREEN LIGHTS.

BMW EfficientDynamics   
Less emissions. More driving pleasure.

Imagine fuel-efficient vehicles that accelerate from 0-62 mph in a mere 4.8 seconds.  
Fuel-efficient vehicles that are extremely aerodynamic.  
Fuel-efficient vehicles that cause excitement even when parked.

Sports cars that use only one gallon of diesel fuel per 62 miles.  
Sports cars that are fueled from a wall socket.

Fuel-efficient vehicles and sports cars like the **BMW Vision EfficientDynamics concept car** make the impossible possible. And demonstrate that a combination of highly efficient transportation and pure emotion can soon become a reality.



BMW is passionate about researching and developing innovations that ensure advanced and efficient driving. This is why every new BMW – like the new 5 Series Sedan – comes with comprehensive, multi-award-winning BMW EfficientDynamics technology. All of BMW's EfficientDynamics features are perfectly matched to reduce fuel consumption and CO<sub>2</sub> emissions while maximizing engine output and dynamic performance. Less fuel, more driving pleasure: a contradiction that BMW has resolved once and for all. It makes for joyful drivers while benefiting the environment.

### High Precision direct fuel injection.

In this latest-generation direct fuel injection system, the piezo injectors are positioned very close to the spark plugs. They inject fuel at high pressure, with extreme precision, for very efficient combustion.

### BMW TwinPower Turbo technology.

This innovative turbocharging technology efficiently reclaims the energy contained in exhaust gases, using two turbochargers (550) or a twin-scroll charger (535).

### 8-speed STEPTRONIC automatic transmission.

The close spacing of gear ratios in this new 8-speed automatic transmission makes maximum use of the optimum rev range, reducing fuel consumption and allowing smoother shifts.

### Valvetronic.

BMW's Valvetronic valve control system improves engine response and refinement, while also helping to reduce fuel consumption. The system helps the engine "breathe" better by providing fully variable lift adjustment of the inlet valves

### Electric Power Steering.

Unlike conventional, hydraulic steering systems, Electric Power Steering draws power only during actual steering movements. When the steering wheel position is constant, the electric motor is inactive.

### Brake Energy Regeneration.

In vehicles with Brake Energy Regeneration, the alternator generates electricity only when the driver takes his or her foot off the accelerator. Kinetic energy that was previously unharnessed is transformed into electrical energy, then fed into the battery. In this way, electricity is generated without consuming fuel.



IT ALL REVOLVES  
AROUND JOY.  
SEVERAL THOUSAND  
TIMES PER MINUTE.

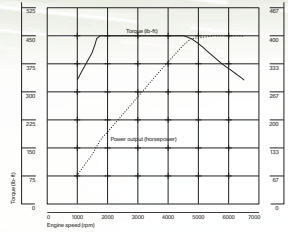
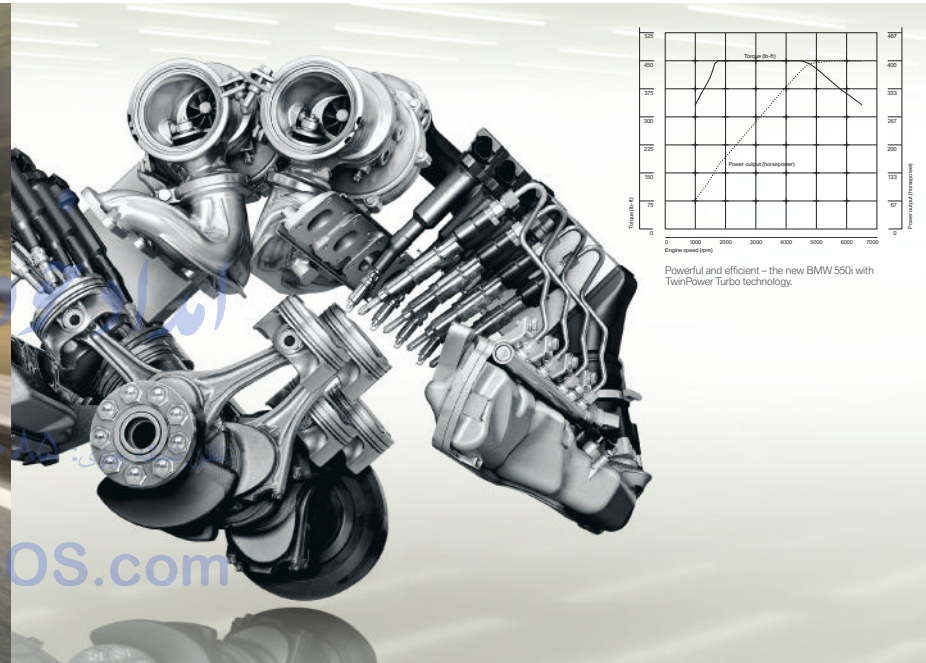

Powerful and efficient – the new BMW 550i with TwinPower Turbo technology.

**Engines that power innovation.** Year after year, BMW engines have garnered accolades for their output, refinement and high-revving ability. Beneath the long hoods of the all-new 5 Series Sedans are three of the world's most sophisticated engines. All are designed to deliver on BMW's EfficientDynamics philosophy: increased power with decreased fuel consumption and emissions. Whichever engine you select, you'll enjoy the thrill of BMW performance while helping to protect the environment every day.

**BMW 550i.**  
BMW's 4.4-liter TwinPower Turbo V-8 is the essence of an iron fist in a velvet glove. Calling on two parallel turbochargers, its robust 400 hp accelerates the 550i smoothly from 0 to 60 mph in 5.0 seconds, while the boost from 450 lb-ft of peak torque is sustained from 1750 all the way to 4500 rpm. Thanks to High Precision injection, this V-8 is also extremely fuel efficient.

**BMW 535i TwinPower Turbo.**  
This unique engine combines a twin-scroll TwinPower Turbo, High Precision direct fuel injection, and – in a first for turbocharged engines – BMW's Valvetronic variable intake technology that helps the engine "breathe" better. The result: turbo lag is virtually eliminated, while posting one of the most fuel-efficient ratings in its class. The 535i TwinPower Turbo develops maximum output of 300 hp at 5800 rpm, redlining at 7000 rpm. Peak torque of 300 lb-ft kicks in almost immediately at 1200 rpm.

It continues to push you back in your seat all the way to 5000 rpm. In just 5.7 seconds you're easily passing 60 mph – and just as easily surpassing all expectations.

**BMW 528i.**  
Hit the accelerator of the 528i, and in 6.6 seconds, you've reached 60 mph, thanks to its potent 240-hp engine. The lightweight composite magnesium/aluminum engine block adds to the spirited acceleration and nimble handling. And with 230 lb-ft of torque, the power pours on early and strong, and continues throughout the powerband.

All 0 to 60 claims: BMW AG test results. BMW urges you to obey all posted speed laws and always wear safety belts.



The all-new 5 Series Sedan offers a host of innovative performance-enhancing technologies as well as active and passive safety features that help you get the most pleasure out of every drive.

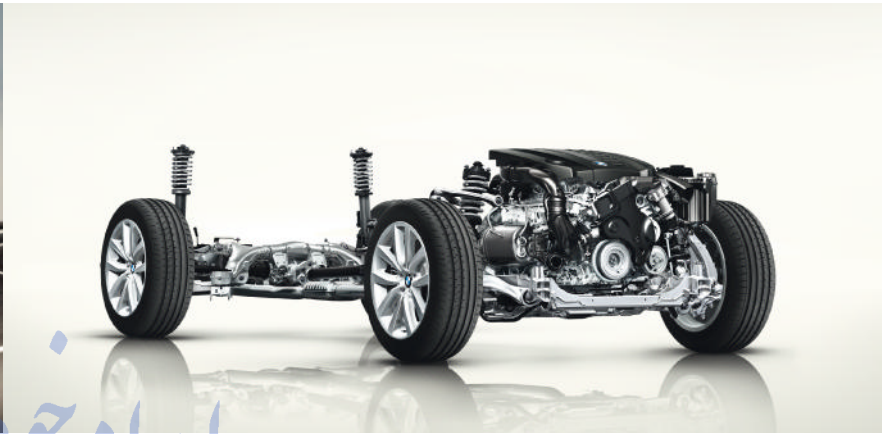

ایراد خودرو فارما

**IF THE ALL-NEW 5 SERIES SEDAN IS BEAUTIFUL TO LOOK AT, WHAT'S INSIDE IS POSITIVELY STUNNING.**

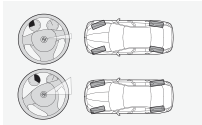

**Integral Active Steering.**

With Integral Active Steering, at speeds up to 30 mph, a small turn of the steering wheel yields a greater turn of the front wheels for more direct response. It also steers the rear wheels up to 2.5 degrees in the opposite direction, giving the effect of a shortened wheelbase for enhanced maneuverability. When changing lanes at speeds over 50 mph, both front and rear wheels turn in the same direction, giving the feel of an extended wheelbase. While you experience greater responsiveness and directional stability, your passengers enjoy greater ride comfort from reduced body roll.

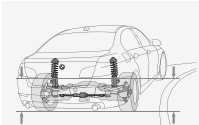

**Adaptive Drive.**

Included in the Dynamic Handling Package, Adaptive Drive combines performance-elevating Active Roll Stabilization (ARS) and ride-enhancing Dynamic Damping Control (DDC). The vehicle's body tends to roll in corners, affecting handling. ARS twists special two-piece anti-roll bars to generate stronger resistance to body roll, keeping the vehicle more level and providing maximum stability and agility. DDC, on the other hand, instantly adjusts shock absorbers from the softest to the firmest settings. The result is exceptional ride comfort and fluid handling at all times – during changes in vehicle speed, load or road and driving conditions.

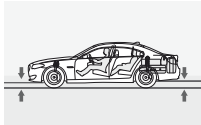

**Driving Dynamics Control.**

By pressing a button, you can adjust the all-new 5 Series Sedan's driving characteristics. Choose from four settings: COMFORT, NORMAL, SPORT and SPORT+, to adjust shock-absorber firmness, engine-throttle response, transmission shift characteristics and power-steering assist. In addition, the traction control feature can be disengaged when driving on sand, gravel, or deep or packed snow.

تلفن شبانه روزی: ۰۲۱-۸۸۸۶۲۰۸۵

FarmaSOS.com

**8-speed Sport Automatic transmission.**

Enjoy quick, comfortable gearshifts, using the gear selector lever or steering wheel-mounted gearshift paddles. The close spacing of the eight gears optimizes acceleration while improving efficiency and shift comfort.

**Double-wishbone front suspension.**

BMW minimizes the effect of poor road surfaces by using a double-wishbone design. This removes lateral and longitudinal forces from acting on the dampers, leaving them free to respond even more sensitively to the road. Both front and rear axles are made entirely of aluminum, which reduces unsprung weight and further enhances comfort.

**Dynamic Stability Control (DSC).**

DSC helps to stabilize the all-new 5 Series Sedan in just milliseconds when it senses an impending skid. Whenever the system senses over- or understeer, it modulates engine power and can apply brakes individually to each wheel to help keep the vehicle under control and going in the intended direction. For sportier driving or in deep snow, **Dynamic Traction Control (DTC)** allows increased wheelslip.

**Passive safety.**

In the event of a collision, the Sedan's safety system determines which of six airbags to deploy for optimal protection. An extremely rigid steel "safety cage" surrounds the cabin, with deformable crush tubes front and rear. In a severe crash, impact energy is routed around the cabin and absorbed by the safety cage. In a severe side impact, a reinforcing bar hooks the door to the body, locking them together to make a more rigid passenger cell. When the pressure is released, the system is designed to snap back so that the doors can open.

For details on the availability of standard and optional features, please refer to the **Equipment charts** at the back of this brochure.

# STAY CONNECTED WITH BMW'S INTELLIGENT NETWORK OF DRIVER, CAR AND ENVIRONMENT.



Every minute, it seems, technological advances allow greater connectivity and interactivity between vehicles, consumer electronics, the internet and the driver.

At BMW, electronic systems will never replace the joy of driving – but they do enhance the driving experience. Take, for example, Automatic high beams that optimize nighttime visibility while making sure oncoming traffic isn't dazzled. A Navigation system that helps you plan

your route and avoid traffic jams, and stores your favorite music. TeleService, part of BMW Assist,<sup>TM</sup> checks your BMW's operating fluids and wear items – and when they need replacing, it automatically notifies your authorized BMW center. Not to mention a staff of response specialists and Concierges, there at the touch of a button, dedicated to assisting you every moment you're on the road. No matter where you go, in a BMW, you're connected with the world.

## Safety technology.

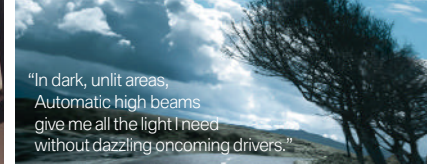

"In dark, unlit areas, Automatic high beams give me all the light I need without dazzling oncoming drivers."



**Automatic high beams** let you enjoy the convenience of switching between high and low beams automatically. When the Automatic high beams system is activated, an image sensor at the back of the rear-view mirror monitors oncoming traffic and lighting conditions. Based on this data, the system decides whether or not the high beams should be switched on. When it detects vehicles ahead, or the sensor indicates that ambient light is sufficient, the high beams are automatically switched off.



BMW's on-board **Navigation system** uses Global Positioning System (GPS) satellites and data stored on an internal hard drive to guide you to your destination, which is displayed on a 16:9 high-resolution screen. Enhancements include 3-D daytime and nighttime maps, zoom, travel planner, and an Assistance Window. The system also offers Voice command for convenient, hands-free operation, and 12 GB of storage for your favorite media files. Online Information Services include MyInfo and, when your vehicle is equipped with BMW Assist Convenience Services, BMW Search.<sup>TM</sup>

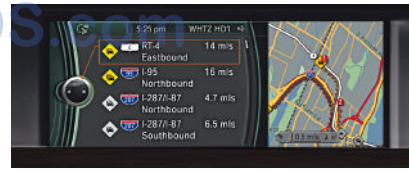

**Real Time Traffic Information** is a valuable feature, included with the Navigation system, that makes you aware of traffic congestion in most large cities before you encounter it. This feature displays and describes current local traffic information on your control display; in case of delays greater than five minutes, it suggests alternate routes.

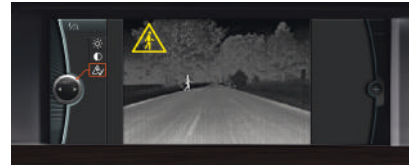

**BMW Night Vision<sup>1</sup> with Pedestrian Detection.** BMW helps you avoid dangerous situations by recognizing them sooner. With this feature, an infrared camera in the front bumper scans up to 900 feet ahead, detecting people and animals – and the direction of their movement, up to 300 feet away. The camera images are shown in the Control Display and, if so equipped, on the Head-up Display. Pedestrian Recognition also gives a visual warning to indicate any people or animals that are moving close to the road.

<sup>1</sup> Night Vision performance is limited by rain, fog, humidity and other weather conditions.

BMW Assist™ – Information.



"With BMW Search™ I get online directions and maps, I can check the weather, and even see how my stocks are doing."

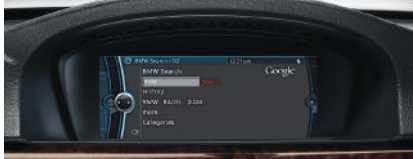
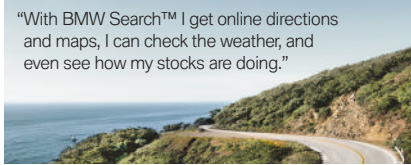

**BMW Search** allows online access to up-to-date fuel prices and gas station locations; the latest weather forecasts, advisories and warnings; Dow Jones, S&P 500 and NASDAQ indices, all updated by Bloomberg; and the powerful reach of the Google Maps™ database – all delivered on the control display inside your vehicle.

**MyInfo** allows you to send business locations and street addresses to your BMW from Google Maps. Destinations and phone numbers can be accessed and exported to your Navigation system for immediate route guidance, while you can call the destination with your Bluetooth® linked phone.

**BMW TeleService** monitors the status of many of your vehicle's fluids and parts that are subject to wear and tear, and automatically transmits the data to your BMW center. Should your vehicle require service, your BMW center will contact you to schedule an appointment. Any needed parts will be ready, so your BMW will be serviced and returned to you as quickly as possible.

BMW Assist – Safety.



"Whenever I'm far from home, I have peace of mind knowing that BMW Assist is right there, ready to help me should I need it."

**TWO FOR THE ROAD: BMW ASSIST SAFETY PLAN AND BMW ASSIST CONVENIENCE PLAN.**

When you're far from home – or just in the next town – it's easy to find your way with confidence and peace of mind with the convenient features and services available on your BMW.

**BMW Assist Safety Plan** gives you peace of mind knowing that a friendly response specialist is there to help you 24/7, at the touch of a button. Enjoy four years of a wide range of services at no additional charge. The Safety Plan includes Automatic Collision Notification, Emergency Request (SOS), TeleService, Enhanced Roadside Assistance, Door Unlock, Stolen Vehicle Recovery, Customer Relations and MyInfo.

**The BMW Assist Convenience Plan** adds personalized Directions, Traffic and Weather reports, BMW Search and Concierge services that not only recommend restaurants and hotels, but then also send the destination address and phone number right to your BMW. You can make up to four operator-assisted calls per year with Critical Calling if your cell phone is not available or its battery is discharged.

**Concierge Services** can help you make reservations at that popular new restaurant, when you simply don't have the time. Need to know the location of a challenging golf course or the nearest post office? Talk to a friendly representative who can get the address and phone number of any desired destination. If your BMW is equipped with the Navigation system, the Concierge can also send this information to your vehicle. Then, at the push of a button, you can start route guidance.



FarmaSOS.com



#### Head-up Display.

When I am in the middle of rush-hour traffic, I don't want to take my eyes off the road, even for a second. Luckily, I don't have to. The Head-up Display projects Navigation instructions and other important information on the windshield, directly in my field of vision. In fact, it looks as if it is floating above the hood. How does Head-up Display work?

Inside the dashboard support structure, there is a monitor – similar to the display in a mobile phone. LEDs generate an image on this display. Then, like a slide projector, four mirrors project the image onto the windshield, enlarging it six times. Due to a clever optical arrangement, it appears to be about six feet away, so the driver's

eyes don't have to keep refocusing. With no need to move the eyes back and forth between the instrument cluster and the road, the driver stays less distracted and more relaxed.

#### Integral Active Steering.

My new 5 Series Sedan has Integral Active Steering. I love driving up in the mountains. Yet even in the middle of tackling the tightest twists and turns, I find I feel totally relaxed. Why is this?

While Active Steering varies just front-wheel steering efforts based on vehicle speed, Integral Active Steering controls the steering angle of both the front and rear wheels. At lower speeds, the rear wheels turn counter to the front wheels. This makes your vehicle feel as if it had a shorter wheelbase, for greater precision on, say, twisting mountain roads. At higher speeds, the rear wheels turn in the same direction as the front wheels. It responds as if it had a longer wheelbase, with enhanced control during quick highway lane changes. In other words, Integral Active Steering handles a lot of the work for you.

#### Active Ventilated Seats.

I drive long distances on my job. My BMW client advisor said that getting Active Ventilated Seats in my new 5 Series Sedan would make a huge difference in how I felt. What do they do?

Active Ventilated Seats are constructed with two hollow cavities in the seat bottom. These are alternately filled and emptied with liquid.

This slow, gentle process raises and lowers the cushion's left and right halves by about half an inch. Although the movement is imperceptible, it acts to move your muscles, increasing blood flow. During long trips, this helps relieve fatigue. With the Ventilation feature, multiple fans inside each front seat blow air upward through the perforated leather, helping to keep you feeling fresh and your clothes free of perspiration.

#### Active Cruise Control.

My BMW center has an all-new 5 Series Sedan equipped with Active Cruise Control. How is this different from regular Cruise Control?

Let's say you're on a congested highway – slow-moving traffic that's more stop than go. It's a situation no driver relishes. But with Active Cruise Control, it's a whole different story. As soon as the vehicle ahead of you stops, your BMW also comes to a smooth, controlled halt. Once traffic starts moving again, so does your BMW, as if it had eyes of its own. And it does: a radar sensor monitors the area in front of the car. Its visual range extends from just in front of the bumper to 500 feet ahead – more than one and one-half football fields – because Active Cruise Control is not just for slow traffic. It also works at higher speeds, up to 110 mph. The system also includes the Forward Collision Warning feature, which uses two warning levels to alert you of a potential collision.



#### BMW Parking Assistant.

Every evening it's always the same: searching for a parking space. I waste so much time and energy trying to squeeze into spots that are too short. My BMW client advisor told me that the all-new 5 Series Sedan has a Parking Assistant feature that can not only find parking spaces, it can even help me park. How does it do that?

When you press the "Parking Assistant" button, drive under 22 mph and keep within five feet of the row of parked cars – on the left or the right – ultrasonic sensors integrated into the side indicators measure the size of all parking spaces. If you pass a space that's at least four feet longer than your vehicle, a green light will come on, and it will appear on your Control Display. Put your vehicle in reverse gear, take your hands off the steering wheel, and press the accelerator or brake pedal. The all-new BMW 5 Series Sedan takes care of everything else. Park Distance Control or the Rear-view Camera will always let you know how close you are to other parked vehicles.

#### iPhone® and Bluetooth® connectivity.

After taking delivery of my new 5 Series Sedan, I got in, pressed the Start button and my favorite song started playing through the speakers.

Was this luck – or BMW technological wizardry?

Once they are connected, or "paired," the all-new 5 Series Sedan communicates perfectly with your iPhone or any other BMW-approved, Bluetooth capable mobile phone. Your address book and the music library are also automatically available. It's all thanks to Bluetooth wireless technology and the hands-free equipment in your BMW. You can access phone numbers stored in your mobile phone via the iDrive Controller or the buttons on the steering wheel. To start a hands-free call, simply press a button. And when you dock your iPod® in the BMW Adapter, your entire music library is also available, via iDrive.



## SIX TECHNICAL QUESTIONS.

## A personalized classic.



Offering an extensive array of exterior paints and interior upholstery and trims, BMW lets you create a statement of your individuality. For example, this BMW 535i Sedan is coated in classic Titanium Silver Metallic paint and upholstered in

handsome Black Dakota Leather upholstery. But it has received the personalizing touch of Light Wood interior trim. The counterpoint of dark leather and Light Wood is beautiful, elegant – and unexpected.

For details on the availability of standard and optional features,<sup>1</sup> please refer to the Equipment charts at the back of this brochure.



## Polished dynamics.



Like a form-fitting tuxedo on an athlete, Black Sapphire Metallic paint elegantly delineates the muscles of the 550i Sedan. Inside the masterfully crafted cabin ringed by Dark Wood trim, comfortable Multi-contour seats are upholstered in Oyster/Black Dakota Leather. The three-spoke sport steering wheel further

enhances the dynamic look and feel of the interior, while 19-inch W Spoke (Style 332) light alloy wheels with run-flat performance tires<sup>1</sup> enhance the 550i's crisp handling.

<sup>1</sup> Run-flat tires do not come equipped with a spare tire and wheel. Due to low-profile tires, please note: wheels, tires and suspension parts are more susceptible to road hazard and consequential damages. Performance tires not recommended for driving in ice and snow.



FarmaSOS.com

## Exterior colors.

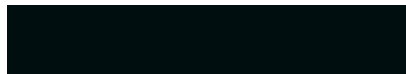

■ 668 Jet Black (Non-metallic)

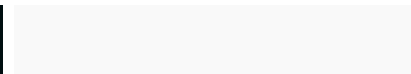

■ 300 Alpine White (Non-metallic)



■ □ 475 Black Sapphire Metallic



■ □ 354 Titanium Silver Metallic



■ □ A52 Space Gray Metallic



■ □ A72 Cashmere Silver Metallic



■ □ A84 Milano Beige Metallic



■ □ A76 Deep Sea Blue Metallic



■ □ A81 Tasman Green Metallic



■ □ A17 Mojave Metallic



■ □ A90 Dark Graphite Metallic



■ □ A89 Imperial Blue Metallic

## Upholstery colors.

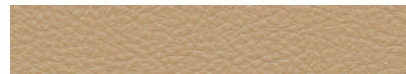

■ K8DF Venetian Beige Leatherette¹



■ K8SW Black Leatherette¹



■ □ LCSW Black Dakota Leather²

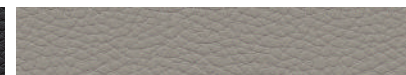

■ □ LCDE Everest Gray Dakota Leather²

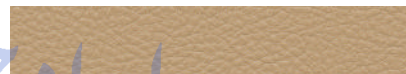

■ □ LCDF Venetian Beige Dakota Leather²

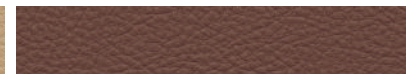

■ □ LCEZ Cinnamon Brown/Black Dakota Leather²



■ □ LCCX Oyster/Black Dakota Leather²



■ □ NASW Black Nappa Leather³

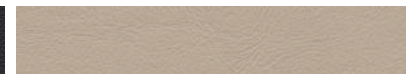

□ NACX Oyster and Black Nappa Leather³

¹ Standard in 528 and 535i; not available in 550i.

² Standard in 550i; optional in 528i and 535i.

³ Optional in all models.

## Interior trims.



4CE Anthracite Wood



4B5 Light Wood



4BN Dark Wood



4B9 Aluminum

Please refer to the Recommended color combinations chart on the facing page for details on limitations and exclusivity when selecting 5 Series Sedan interior trim.

## Recommended color combinations.

Interior colors	Leatherette <sup>1</sup>		Dakota Leather <sup>2</sup>				Nappa Leather <sup>3</sup>		
	Venetian Beige	Black	Black	Everest Gray	Venetian Beige	Cinnamon Brown/Black	Oyster/Black	Black	Oyster and Black
<b>Upholstery colors</b>									
<b>Exterior colors</b>									
668 Jet Black (Non-metallic) <sup>4</sup>	•	•	•	•	•	•	•	•	•
300 Alpine White (Non-metallic) <sup>4</sup>	•	•	•	•	•	•	•	•	•
475 Black Sapphire Metallic <sup>2</sup>	•	•	•	•	•	•	•	•	•
354 Titanium Silver Metallic <sup>2</sup>	•	•	•	•	•	•	•	•	•
A52 Space Gray Metallic <sup>2</sup>	•	•	•	•	•	•	•	•	•
A72 Cashmere Silver Metallic <sup>2</sup>	•	•	•	•	•	•	•	•	•
AB4 Milano Beige Metallic <sup>2</sup>	•	•	•	•	•	•	•	•	•
A76 Deep Sea Blue Metallic <sup>2</sup>	•	•	•	•	•	•	•	•	•
AB1 Tasman Green Metallic <sup>2</sup>	•	•	•	•	•	•	•	•	•
A17 Mojave Metallic <sup>2</sup>	•	•	•	•	•	•	•	•	•
A90 Dark Graphite Metallic <sup>2</sup>	•	•	•	•	•	•	•	•	•
AB9 Imperial Blue Metallic <sup>2</sup>	•	•	•	•	•	•	•	•	•
<b>Interior trims</b>									
4CE Anthracite Wood <sup>1</sup>	•	•	•	•	•	•	•	•	•
4B5 Light Wood <sup>3</sup>	•	•	•	•	•	•	•	•	•
4BN Dark Wood <sup>3</sup>	•	•	•	•	•	•	•	•	•
4B9 Aluminum <sup>3</sup>	•	•	•	•	•	•	•	•	•

<sup>1</sup> Standard in 528i and 535i. Not available in 550i.

<sup>2</sup> Standard in 550i; optional in 528i and 535i.

<sup>3</sup> Optional.

<sup>4</sup> Standard in all models.

[bmwusa.com/byo](http://bmwusa.com/byo)

For details on the availability of standard and optional features, please refer to the **Equipment charts** at the back of this brochure.



## Standard/optional equipment.



**Xenon Adaptive Headlights** optimize road illumination when entering a turn or corner, helping to enhance visibility when driving at night. Sensors continuously monitor the angle of the steering wheel to determine the direction in which your vehicle is heading. The outer headlights swivel accordingly, up to 15 degrees left or right.

**Xenon low- and high-beam headlights** illuminate the road ahead and to the side with brilliant clarity. An auto-leveling feature adjusts for varying passenger and cargo loads. LED **Corona headlight-rings** that circle both headlights and high beams also act separately as Daytime Running Lights and parking lights.



**Taillight cluster** with taillight, brakelight and turn-signal indicators incorporate LED technology for greater visibility.

**Adaptive Brake Lights** warn following vehicles by increasing in brightness when the intensity of your braking action is increased.



**Two-way power glass moonroof** with remote, expanded one-touch operation slides back or tilts up to let in as much fresh air and sky as you like, while the wind deflector helps keep the interior breeze-free. A sliding interior sunshade shields passengers from sun heat and glare.



**Shadowline trim** replaces the front and rear side-window chrome frames and door-sill trim strips with the more rugged, sporting look of a black high-gloss finish.



**Heated, power-adjustable exterior mirrors** feature a body-color upper section, black bottom.

**Automatic-dimming exterior mirrors** cut headlight glare from any following vehicles, and include power-folding function.



**Door handles** combine sleek design and practical use. The horizontal chrome accent strip incorporates courtesy lights that illuminate the immediate area when the door is unlocked.



**Two circular-shape chrome-surround exhaust tips** are cleanly integrated into the left side of the 528i rear bumper. The 535i is identified by one exhaust tip on the left side and one on the right.



**Dual rectangular-shape chrome-surround exhaust tips** are integrated into each side of the rear fascia of the 550i. Their trapezoidal styling identifies the V-8 model.



**Star Spoke (Style 327)** 17 x 8.0 light alloy wheels with 225/55 **run-flat<sup>1</sup>** all-season tires.



**Radial Spoke (Style 237)** 18 x 8.0 light alloy wheels with 245/45 **run-flat<sup>1</sup>** all-season tires.<sup>2</sup>



**V Spoke (Style 328)** 18 x 8.0 light alloy wheels with 245/45 **run-flat<sup>1</sup>** performance tires.<sup>2,3</sup>



**V Spoke (Style 331)** 19 x 8.5 front, 19 x 9.0 rear light alloy wheels with 245/40 front and 275/35 rear **run-flat<sup>1</sup>** performance tires.<sup>2,3</sup>



**W Spoke (Style 332)** 19 x 8.5 front, 19 x 9.0 rear light alloy wheels with 245/40 front and 275/35 rear **run-flat<sup>1</sup>** performance tires.<sup>2,3</sup>



**Star Spoke (Style 330)** 18 x 8.0 light alloy wheels with 245/45 **run-flat<sup>1</sup>** all-season tires.<sup>2</sup>

<sup>1</sup> Run-flat tires do not come equipped with a spare tire and wheel.

<sup>2</sup> Due to low-profile tires, please note: wheels, tires and suspension parts are more susceptible to road hazard and consequential damages.

<sup>3</sup> Performance tires not recommended for driving in ice and snow conditions.

For details on the availability of standard and optional features, please refer to the **Equipment charts** in the following section of this brochure.

## Standard/optional equipment.



■ **Three-spoke leather-wrapped multi-function sport steering wheel**, featuring power tiltelescoping adjustments, lets you keep both hands on the steering wheel while adjusting the audio as well as a BMW-approved, Bluetooth enabled mobile phone, if so equipped. The left-hand buttons operate all Cruise Control functions, while those on the right control audio functions, such as the radio and, if so equipped, telephone and Voice command.

□ **Heated steering wheel** is a feature that, like heated seats, becomes a "must-have" once it's experienced. The heating switch is conveniently located on the multi-function steering wheel.



■ **6-speed manual transmission** delivers a precise, athletic feel. Its responsiveness is due, in part, to the synchronization of shifts from neutral to each gear. The shortened shift lever and "throw" add to the sporty feel of the gearbox. The sixth gear drops revs at highway speeds for smooth cruising and better fuel economy.



□ **8-speed Sport Automatic transmission** with Adaptive Transmission Control (ADT) provides extremely fast synchronized shifting, whether performed by the Automatic shift mode or by the race-inspired steering wheel-mounted paddle shifters.



■ **Three-spoke leather-wrapped multi-function steering wheel** provides buttons on the left for operating the Cruise Control functions, and buttons on the right for adjusting all audio-related functions, including a BMW-approved, Bluetooth® enabled mobile phone, if so equipped.



■ **Engine Start/Stop button and remote key** control the engine. First, insert the remote key into the starter switch slot. After the electronic identification system confirms that it is the correct remote key, you can start (or later, turn off) the engine by pressing the Start/Stop button. (Foot must be on brake in order to start.)



■ **Cruise Control<sup>1</sup>** lets you store and maintain a chosen speed above approximately 18.5 mph by accessing the feature's buttons on the left side of the multi-function steering wheel.



□ **Active Cruise Control (ACC) with Stop & Go<sup>1</sup>** lets you preset both desired speed and following distance. When ACC recognizes slower vehicles ahead, it reduces your speed to maintain the preset distance. Stop & Go can bring you to a complete stop if traffic dials for it. When you press the accelerator, ACC resumes your speed according to your presets.



■ **Black Panel Display** shows the instrument cluster as a matte black surface when the ignition is switched off, with the instrument rings of the circular instruments visible in 3-D. When the ignition is switched on, the graphics display lights up, showing the trip computer and Check Control information; below the four analog dials is a high-res, wide-format Info Display.

<sup>1</sup> Cruise Control is not a substitute for the driver's own responsibility in adjusting speed and otherwise controlling the vehicle. After evaluating the road, traffic and visibility conditions, the driver must decide whether and how the system is used.

<sup>2</sup> Requires clearly definable lane markings that are not obscured by rain, snow, etc. Lane Departure Warning feature is not a substitute for the driver's own responsibility in maintaining safe control of the vehicle.

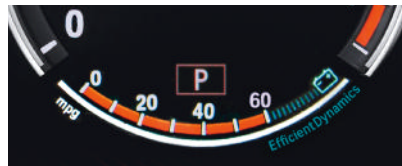

■ **BMW EfficientDynamics** in action: each time you take your foot off the gas pedal, Brake Energy Regeneration transforms the vehicle's kinetic energy into electricity, which is used to charge the battery. As a result, the battery draws less power from the engine, effectively reducing fuel consumption. Whenever this occurs, a blue indicator in the tachometer lights up.



□ **Lane Departure Warning feature<sup>2</sup>** senses when your vehicle is crossing over roadway lane markings or is changing lanes without signaling, and warns you by sending a mild vibration through the steering wheel. The system can be turned on and off via a button by the steering wheel.



□ **Active Blind Spot Detection** is activated when you use the turn-signal indicator before changing lanes. This feature warns if a vehicle is in your blind spot, or if a vehicle is approaching at high speed in the passing lane.

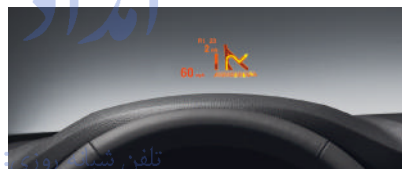

□ **Head-up Display** projects important travel information, such as current speed and Check Control data, on the windshield directly in your line of vision. Directional arrows from the Navigation system (if so equipped) can also be displayed.



□ **Parking Assistant** makes parking a breeze by searching for suitable parking spots and then steering your vehicle into them. Simply press the "Park Assistant" button, then drive along potential parking spaces on the left or right side of the road, staying below 22 mph and no more than five feet away. Using ultrasonic sensors integrated into the side indicators, the system searches for and measures parking spaces. When a space at least four feet longer than your vehicle is spotted, it is shown on your Control Display. Shift into reverse and Park Assistant takes control of steering your vehicle into the selected space; you operate the accelerator and brake pedals. The acoustic and visual warnings of Park Distance Control (PDC) provide assistance.



□ **Rear-view Camera** shows on the Control Display the area behind your vehicle. Working with Park Distance Control, interactive guidelines indicate if a parking space can accommodate the vehicle, and display parking trajectories and turn angles. The Rear-view Camera is activated by engaging reverse gear.

■ **Park Distance Control (PDC)** uses eight sensors – four in the front, four in the rear – to help you judge how close you are to other vehicles and unseen objects when parking. The warning beeps come faster as the bumper approaches the object, turning into a constant tone when the distance is less than 12 inches.



□ **Side- and Top-view Cameras** display video images on the Control Display of traffic approaching the front of the vehicle from the sides, such as when exiting a garage or parking space, by using cameras positioned in the front bumpers. The Top-view Camera provides video images of the road alongside doors, taken by cameras positioned in the exterior mirrors. (Delayed availability for Side-view cameras.)

For details on the availability of standard and optional features, please refer to the **Equipment charts** in the following section of this brochure.

## Standard/optional equipment.



■ **iDrive Controller**, conveniently located on the center console, is the central command element for the iDrive system. It can be rotated, pushed and lifted to operate various functions via the Control Display. Four frequently selected menus – CD, radio, Navigation system and telephone – can be called up using direct menu-control buttons.



■ **Control Display** shows the functions of the iDrive Controller, vehicle settings and radio, as well as the Navigation system. The glare-free, high-resolution color monitor is located next to the instrument cluster at an ideal viewing height and distance.



■ **BMW Assist™** and Bluetooth® system offers hands-free calling through your BMW-approved Bluetooth phone. The BMW Assist Safety Plan is included for four years, providing Automatic Collision Notification, Emergency Request, Roadside Assistance, Door Unlock, Stolen Vehicle Recovery, TeleService and more. The optional Convenience Plan offers Directions, Traffic, Weather, Critical Calling and Concierge services, as well as BMW Search™ which allows online access to current fuel prices, weather forecasts, Bloomberg's stock indices and the powerful reach of the Google Maps™ database. (See page 66 for details of standard and optional services available with BMW Assist.)



■ □ **Navigation system** features a high-resolution, glare-free monitor, and uses GPS satellites in conjunction with data stored on an internal hard drive. Includes 3-D daytime and nighttime maps, zoom, travel planner and an Assistance Window. The system provides Real Time Traffic information on potential traffic problems and solutions.



■ □ **Hard disc drive**, included as part of the Navigation system, provides 12 GB of storage space. Store and quickly access media files or up to 2,000 songs, transferred from a CD, MP3 player or USB stick.



■ **Integrated Owner's Manual** provides quick and immediate access to all vehicle-specific information. The Owner's Manual can be accessed via the iDrive and shown on the Control Display. The system's user-friendly features include multimedia elements such as animations and dynamic illustrations.



□ **BMW Night Vision with Pedestrian Detection** can scan up to 900 feet ahead using an infrared camera in the front bumper.<sup>1</sup> It can detect people and animals, as well as the direction of their movement, up to approximately 300 feet away, and displays their presence on the Drive screen and Head-up Display (if so equipped). The system gives a visual warning as soon as pedestrians or animals move toward the road, alerting you to potential dangers significantly earlier, so you can react more quickly.



<sup>1</sup> Under optimal road conditions. Night Vision performance is also limited by rain, fog, humidity and other weather conditions.



■ **BMW anti-theft AM/FM stereo CD/MP3 audio system** offers Radio Data System (RDS), Auto-Store, and 3-channel FM diversity antenna system. □ **Premium high-fidelity system** is a 16-speaker, multi-channel system that outputs reproduction of the surround information contained in the stereo signal in a nine-channel format (seven mid- and high-range channels and two central bass channels) as well as 5.1 surround sound from a DVD source. Includes a 600-watt digital amplifier with nine channels. The system compensates for driving noise in smooth steps with speed-dependent equalizing. All speakers are fitted with very strong, yet compact neodymium drives.



□ **Rear-seat entertainment** includes two tilt-adjustable, independently operated 8-inch color screens integrated into the back of the front seats. The system includes a remote control and headphone jacks.



■ **AUX-IN connection**, includes a 12V power outlet, for an external audio device. □ **Smartphone Integration**, for iPhone® and similar devices, allows access to stored music, can improve signal reception, and recharges the phone battery. See your BMW center for phone models compatible with this option.



■ **2-zone automatic climate control** allows driver and front passenger to select individual temperatures and choice of fan speeds, as well as choose automatic or manual airflow and recirculation. The automatic recirculation control activates whenever certain air pollutants are detected. The system also features a mist-up sensor, solar sensor and residual heat use.



□ **4-zone automatic air conditioning** builds on the 2-zone system with air vents in the B-pillar and at the rear of the center console, to ensure virtually draftless ventilation for rear-seat passengers. Additionally, the temperature in both left and right rear cabin can be tailored via two control dials with displays.

For details on the availability of standard and optional features, please refer to the **Equipment charts** in the following section of this brochure.

## Standard/optional equipment.



□ **18-way power Multi-contour front seats** conform to your body to provide optimum support and exceptional comfort over long distances.

In addition to horizontal, vertical and angled adjustments, Multi-contour seats include an articulated upper backrest, Comfort headrest (two-way power, two-way manual "relax headrest"), and four-way power-adjustable lumbar support. Both driver's and front-passenger's seats include memory function.

□ **Active front seats** imperceptibly raise and lower the left and right halves of the seating surface. This movement keeps the spine in motion, exercising various support muscles to help reduce fatigue on longer trips.



□ **Power rear sunshade** can be extended with the touch of a button to protect the cabin from the sun's rays in warm weather or retracted to allow the sun to help warm the interior in colder weather.



□ **Rear side sunshades** keep the sun's heat and glare away from the rear cabin while maintaining your privacy. When not in use, these manually adjustable sunshades conveniently disappear into the side doors.



□ **Rear seat backrests** can be folded individually in a 60/40 split to optimize the number of passengers and amount of cargo.

□ **Ski bag** can accommodate up to four pairs of skis or other long objects for practical transport inside the vehicle. The bag protects transported items while simultaneously protecting the vehicle interior from damage.

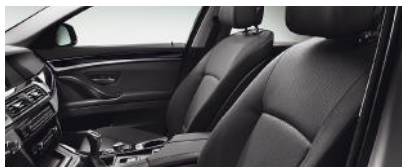

■ **10-way power-adjustable driver's and front passenger's seats** with memory system for driver's seat, steering wheel and outside mirrors.

■ **Lumbar support** in the front seats adds four-way power-adjustable support for the lower back. Lumbar positions can be customized with up/down and in/out adjustments.

□ **Heated rear seats** are a welcome feature in cooler weather for left and right rear-seat occupants. With the touch of a button, passengers can individually select their preferred level of warmth.

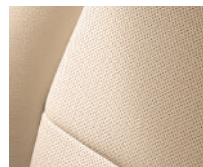

□ **Active Ventilated seats** gently blows warm or cool air through the micro-perforations in the leather to keep driver and front passenger comfortably dry in hot weather, and warm in colder weather.



■ **Front armrest** with integrated storage compartment opens up to allow access to the optional iPod® and USB adapters, and Smartphone Integration adapter.



■ □ **Ambiance lighting** adds a touch of elegance to cabin lighting. Turn the headlights on to enjoy the drama of a warm reddish light that runs from front to rear beneath the inner door ledge. Interior lighting also includes soft white rear reading and footwell lights, illumination of the front center armrest storage compartment, indirectly lit door pockets, exit lights, and proximity illumination in the outside door handles.



■ **Storage compartment beneath the luggage compartment floor** offers additional storage space, thanks to the use of run-flat tires, which eliminates the need for a spare tire and wheel. The luggage compartment itself is illuminated and fully finished and includes an interior and remote trunk release.

□ **Power trunk lid** operation provides automatic opening and closing via remote control.

■ **Central locking** for the doors and fuel cap, including Cooled Drivesaway Protection and a remote control with automatically recharging battery in the key.



□ **Comfort Access system** offers an even greater degree of convenience: keyless access to your vehicle. Simply carrying the remote key in a pocket or purse allows you to unlock the doors by touching the door handle. You can also turn the engine on or off by pressing the Start/Stop button without the remote key. (Note: foot must be on brake to start the engine.)

For details on the availability of standard and optional features, please refer to the **Equipment charts** in the following section of this brochure.

■ Standard □ Optional or included in optional package

ایراد خودرو فارما

۰۲۱-۸۸۸۶۲۰۸۵

FarmaSOS.com

## Equipped with the best ideas. Original BMW Accessories.

Driving a BMW is always a special experience, which can be enhanced even further with Original BMW Accessories. Benefit from innovative solutions combining unique ideas, stunning design and supreme functionality. Discover the wide range of Original BMW Accessories available to you, enhancing such vehicle aspects as the exterior, interior, technology, transporters, protection and details to customize your vehicle. For additional information on Original BMW Accessories, please visit your authorized BMW center or

[bmwusa.com/accessories](http://bmwusa.com/accessories)



Leave a sporty impression with a **Carbon Fiber Rear Deck Lid Spoiler** and **20" Cross Spoke (Style 312)** cast alloy wheels coated in BMW Ferric Gray.

# FarmaSOS.com

BMW's selection of **trunk mats** help keep your trunk protected, clean and looking new.



**Snap-in Adapter with USB interface** plays stored music through your vehicle speakers, charges the phone and accesses the car antenna for better reception.



**Infrared stereo headphones**, specially designed for use with the optional BMW rear-seat entertainment system.

Performance and efficiency	528i	535i	550i
3.0-liter dual overhead cam (DOHC), 24-valve inline 240-horsepower 6-cylinder engine with composite magnesium/aluminum engine block, Valvetronic, and Double-VANOS steplessly variable valve timing	●		
3.0-liter, dual overhead cam (DOHC), 24-valve, 300-hp inline 6-cylinder engine with TwinPower Turbo technology, piezo direct fuel injection, Valvetronic, and Double-VANOS steplessly variable valve timing		●	
4.4-liter, 32-valve 400-hp V-8 engine with TwinPower Turbo technology, piezo direct fuel injection, 4 overhead camshafts, and Double-VANOS steplessly variable valve timing			●
Direct ignition system with knock control	●	●	●
Electronically controlled engine cooling (map cooling)	●	●	●
6-speed manual transmission	●	●	●
8-speed automatic transmission with Sport and Manual shift modes and Adaptive Transmission Control (ATC)	●	○	○
8-speed Sport Automatic transmission with Sport and Manual shift modes and steering wheel-mounted paddle shifters (requires Sport Package)	○	○	○

Handling, ride and braking	528i	535i	550i
Twin-tube gas-pressure shock absorbers	●	●	●
4-wheel ventilated anti-lock disc brakes (ABS) with composite front rotors and Dynamic Brake Control (DBC), and brake pad wear indicators	●	●	●
Vehicle-speed-sensitive variable-assist (Servotronic), variable-ratio power steering	●	●	●
Dynamic Stability Control (DSC), including Brake Fade Compensation, Start-off Assistant, Brake Drying, and Brake Stand-by features, with Dynamic Traction Control (DTC)	●	●	●
Electronic limited-slip differential	●	●	●
Brake Energy Regeneration system	●	●	●
Driving Dynamics Control	○	○	○
Dynamic Damping Control	▲	▲	▲
Active Roll Stabilization	▲	▲	▲
Integral Active Steering with Servotronic power assist (requires Dynamic Handling Package)		○	○
Increased top-speed limiter	□	□	□

Exterior and aerodynamics	528i	535i	550i
Star Spoke (Style 327) 17 x 8.0 light alloy wheels, 225/55 run-flat <sup>1</sup> all-season tires	●		
Radial Spoke (Style 237) 18 x 8.0 light alloy wheels, 245/45 run-flat <sup>1</sup> all-season tires <sup>2</sup>		●	
Star Spoke (Style 330) 18 x 8.0 light alloy wheels, 245/45 rear run-flat <sup>1</sup> all-season tires <sup>2</sup>			●
V Spoke (Style 328) 18 x 8.0 light alloy wheels, 245/45 run-flat <sup>1</sup> performance tires <sup>2, 3</sup>	□		
V Spoke (Style 331) 19 x 8.5 front, 19 x 9.0 rear light alloy wheels; 245/40 front, 275/35 rear run-flat <sup>1</sup> performance tires <sup>2, 3</sup>		□	
W Spoke (Style 332) 19 x 8.5 front, 19 x 9.0 rear light alloy wheels; 245/40 front, 275/35 rear run-flat <sup>1</sup> performance tires <sup>2, 3</sup>			□
Xenon Adaptive Headlights with dynamic auto-leveling, LED Corona headlight-rings and Cornering Lights	○	●	●
Front foglights	●	●	●
Retractable, high-intensity headlight washers	★	★	★
Rain-sensing windshield wipers with adjustable speed	●	●	●
Power adjustable, heated, folding, body-color side-view mirrors	●	●	●
Metallic paint	○	○	●
Shadowline exterior trim	□	□	□

- Standard
- Optional
- ▲ Included in Dynamic Handling Package
- Included in Sport Package
- △ Included in Active Ventilated Seat Package
- ★ Included in Cold Weather Package
- ◆ Included in Premium Package
- ◆ Included in Premium Package II

<sup>1</sup> Run-flat tires do not come equipped with a spare tire and wheel.  
<sup>2</sup> Due to low-profile tires, please note: wheels, tires and suspension parts are more susceptible to road hazard and consequential damages.  
<sup>3</sup> Performance tires not recommended for driving in ice and snow.

Interior seating and trim	528i	535i	550i
10-way power-adjustable driver's and front passenger's seat with 4-way lumbar support, and memory system for driver's seat, steering wheel and outside mirrors	●	●	●
18-way power Multi-contour front seats; includes articulated upper backrest, 4-way lumbar support, passenger's seat memory, Active Head Restraints, and adjustable thigh support	○/△/□	○/△/□	○/△/□
Active Ventilated front seats	△	△	△
Active front seats	△	△	△
3-stage heated front seats	○/△/★/◆	○/△/★/◆	○/△/★/◆
Heated rear seats	★	★	★
Leatherette upholstery	●	●	●
Dakota Leather upholstery and door trim	○/◇	○/◇	●
Nappa Leather upholstery and door trim	○	○	○
Dark Wood trim	●	●	●
Light Wood trim	○	○	○
Anthraxite Wood trim	○	○	○
Aluminum trim	○	○	○
Open storage compartments in all doors and front seatback storage	●	●	●
Foldup rear seat center armrest	●	●	●
Split fold-down rear seats	○	○	○
Floor mats	●	●	●

Audio system	528i	535i	550i
Anti-theft AM/FM stereo/CD audio system with Auto-Store, FM diversity antenna system, and MP3 capabilities	●	●	●
High-fidelity 12-speaker sound system, including 2 subwoofers under the front seats, and digital 7-channel amplifier with 205 watts of power	●	●	●
Enhanced Premium High-fidelity 16-speaker sound system with Digital Sound Processing (DSP), 2 subwoofers under the front seats and digital 9-channel amplifier with 600 watts of power	◆	◆	◆
HD Radio™ with "multicast" FM station reception	●	●	●
iPod® and USB adapter (includes cable connector)	○/◆	○/◆	○/◆
Smartphone Integration (for iPhone® and similar devices) – charges the phone, accesses stored music, and improves phone reception	○	○	○
Satellite radio preparation	●	●	●
SIRIUS Satellite Radio with one-year subscription (please visit your authorized BMW center for details on services and equipment)	○/◆	○/◆	○/◆
Rear-seat entertainment	○	○	○

Comfort and convenience	528i	535i	550i
Engine Start/Stop button	●	●	●
Vehicle & Key Memory	●	●	●
2-way power moonroof with remote, expanded "one-touch" operation, anti-trapping feature, and sliding interior sunshade	●	●	●
Power windows with key-off and "one touch" up and down operation both front and rear, anti-trapping feature, opening from remote, and closing from exterior lock	●	●	●
Power trunk lid opening and closing	☆	☆	☆
Automatic climate control with separate left/right temperature and air distribution controls, with automatic air recirculation	●	●	●
4-zone automatic climate control with 4 individual temperature settings	○	○	○
Micro-filter ventilation system with replaceable active-charcoal filters	●	●	●
Automatic tilt-down of passenger's side-view mirror (when car is shifted into reverse gear)	●	●	●
Power tilt and telescopic steering wheel with automatic tilt-up for easy entry and exit	●	●	●
Park Distance Control (front and rear)	○◆	○◆	○◆
Parking Assistant	■	■	■
Automatic high beams	■	■	■
Heated steering wheel	★	★	★
Comfort Access keyless entry with multi-function remote control	○☆	○☆	○☆
Automatic-dimming interior rear-view mirror and exterior side-view mirrors	◇	◇	◇
Soft-close automatic door operation	☆	☆	☆
Manual rear side-window sunshades and power rear-window sunshade	○◆	○◆	○◆
Interior Ambiance lighting	◇	◇	◇
Interior courtesy lights with automatic dimming function	●	●	●
Front map lights and rear reading lights with separate controls for the left and right	●	●	●
Dual front sun visors with illuminated mirrors	●	●	●
Dual cupholders in front and rear	●	●	●
Automatic headlight on/off control	●	●	●
Fully finished trunk with interior and remote trunk release	●	●	●
Power outlet in front passenger's footwell, front center console storage compartment, rear center console, and in trunk	●	●	●
Glove compartment	●	●	●
Ski bag (requires split fold-down rear seats)	○	○	○

**Instrumentation and controls**

3-spoke leather-wrapped multi-function steering wheel with controls for audio system, cruise control, and Bluetooth® wireless communication for hands-free mobile phone (if so equipped) <sup>4</sup>	●	●	●
3-spoke leather-wrapped multi-function sport steering wheel with controls for audio system, cruise control, and Bluetooth wireless communication for hands-free mobile phone (if so equipped) <sup>4</sup>	□	□	□
Electronic analog speedometer and tachometer	●	●	●
iDrive system with on-board computer and Controller, and 8 programmable memory buttons	●	●	●
Condition-based Service display with additional functions accessible through iDrive system	●	●	●
Service Interval Indicator and expanded Check Control vehicle monitor system	●	●	●

- Standard
- Optional
- ☆ Included in Convenience Package
- ◆ Included in Premium Package
- ◆ Included in Premium Package II
- Included in Driver Assistance Package
- ★ Included in Cold Weather Package
- Included in Sport Package

<sup>4</sup> Check for a list of BMW-compatible Bluetooth enabled mobile phones at your authorized BMW center or bmwusa.com.  
<sup>5</sup> Cruise Control is not a substitute for the driver's own responsibility in adjusting speed and otherwise controlling the vehicle. After evaluating the road, traffic and visibility conditions, the driver must decide whether and how the system is used.  
<sup>6</sup> Requires clearly definable lane markings that are not obscured by rain, snow, etc. Lane Departure Warning feature is not a substitute for the driver's own responsibility in maintaining safe control of the vehicle.  
<sup>7</sup> For more information please refer to page 66 or visit bmwassist.com.

Instrumentation and controls (Continued)	528i	535i	550i
Tire Pressure Monitor	●	●	●
Rear-window defroster	●	●	●
Dynamic Cruise Control <sup>5</sup>	●	●	●
Active Cruise Control (ACC) with Stop & Go <sup>6</sup>	○	○	○
Hard drive-based Navigation system with voice feedback, Voice command system and Real Time Traffic Information	○◆	○◆	○◆
Black Panel Display	●	●	●
Head-up Display (HUD)	○	○	○
Night Vision with Pedestrian Detection (Night Vision performance is limited by rain, fog, humidity and other weather conditions; requires Cold Weather Package)	○	○	○
Integrated 3-button Universal garage-door opener	○	○	●
Rear-view Camera (528i and 535i require Park Distance Control)	○◆	○◆	○◆
Side- and Top-view Cameras include Top View (video of road alongside doors, taken by cameras in exterior mirrors) and Side View (video of traffic approaching vehicle from the side, taken by cameras in front bumper); images displayed on the Control Display (requires Rear-view Camera; Side-view Cameras; delayed availability)	○	○	○

**Safety and security**

Driver's and passenger's front airbag supplemental restraint system (SRS) with advanced technology; dual-threshold, dual-stage deployment; and front-passenger seat sensors designed to prevent unnecessary airbag deployment	●	●	●
3-point safety belts with force limiters and head restraints at all seating positions	●	●	●
Active Head Restraints for driver and front passenger	●	●	●
Front- and rear-seat Head Protection System (HPS)	●	●	●
Front-seat side-impact airbags	●	●	●
Acoustic safety-belt warning	●	●	●
Front safety belts with automatic pretensioners	●	●	●
Lane Departure Warning feature that alerts the driver of an improper lane-changing maneuver <sup>6</sup>	■	■	■
Active Blind Spot Detection <sup>7</sup>	■	■	■
LATCH attachments on child-restraint safety installation	●	●	●
Interlocking door anchoring system to help protect against door intrusion in side impacts	●	●	●
BMW's Advanced Safety System for integrated deployment of passive and active safety features	●	●	●
Crash sensor that activates Battery Safety Terminal disconnect of alternator, fuel pump and starter from battery; automatically unlocks doors, and turns on hazard and interior lights	●	●	●
Anti-theft alarm system with keypad remote operation and interior motion detector	●	●	●
Remote keyless entry security alarm system with selective unlocking and double-lock feature (programmed at BMW center), remote trunk opening, interior motion detector, and panic feature	●	●	●
Adaptive Brake Lights	●	●	●
Bluetooth wireless technology for hands-free calling (with Bluetooth compatible mobile phone, if so equipped <sup>7</sup> ), phonebook downloading and speech recognition capabilities (please visit your authorized BMW center for details on standard and optional services)	●	●	●
BMW Assist™ Safety Plan: includes four years of Automatic Collision Notification, Emergency Request, Enhanced Roadside Assistance, Door Unlock, Stolen Vehicle Recovery, Customer Relations, TeleService, MyInfo lets you send business locations and street addresses directly to your BMW and Navigation system (if so equipped) <sup>7</sup>	●	●	●
BMW Assist Convenience Plan: includes unlimited personalized Directions, Traffic and Weather reports; Concierge service; BMW Search™ for online access to up-to-date fuel prices, weather forecasts and Bloomberg's stock indices; Google Maps™ database; Critical Calling (4 operator-assisted calls per year) <sup>7</sup>	○	○	○

**BMW Services**

BMW Ultimate Service™ (for complete details on BMW Ultimate Service, visit bmwusa.com/ultimateservice)	●	●	●
--	---	---	---

Active Ventilated Seat Package	528i	535i	550i
18-way power Multi-contour front seats; includes articulated upper backrest, 4-way lumbar support, passenger's-seat memory, Active Head Restraints, and adjustable thigh support	○△□	○△□	○△□
Active Ventilated front seats	△	△	△
Active front seats	△	△	△
3-stage heated front seats	○△★◆	○△★◆	○△★◆

Convenience Package (528i and 535i require Premium Package)			
Power trunk lid opening and closing	☆	☆	☆
Comfort Access keyless entry with multi-function remote control	○☆	○☆	○☆
Soft-close automatic door operation	☆	☆	☆

Cold Weather Package			
Retractable, high-intensity headlight washers	★	★	★
3-stage heated front seats	○△★◆	○△★◆	○△★◆
Heated rear seats	★	★	★
Heated steering wheel	★	★	★

Driver Assistance Package (528i and 535i require Park Distance Control)			
Parking Assistant	■	■	■
Automatic high beams	■	■	■
Lane Departure Warning feature that alerts the driver of an improper lane-changing maneuver <sup>8</sup>	■	■	■
Active Blind Spot Detection	■	■	■

Dynamic Handling Package (Requires Sport Package)			
Dynamic Damping Control	▲	▲	▲
Active Roll Stabilization		▲	▲

- Standard
- Optional
- △ Included in Active Ventilated Seat Package
- ☆ Included in Convenience Package
- ★ Included in Cold Weather Package
- Included in Driver Assistance Package
- ▲ Included in Dynamic Handling Package
- ◆ Included in Premium Package
- ◆ Included in Premium Package II
- Included in Sport Package

<sup>8</sup> Requires clearly definable lane markings that are not obscured by rain, snow, etc. Lane Departure Warning feature is not a substitute for the driver's own responsibility in maintaining safe control of the vehicle.

<sup>9</sup> Run-flat tires do not come equipped with a spare tire and wheel.

<sup>10</sup> Due to low-profile tires, please note: wheels, tires and suspension parts are more susceptible to road hazard and consequential damages. Performance tires not recommended for driving in ice and snow.

<sup>11</sup> Check for a list of BMW-compatible Bluetooth enabled mobile phones at your authorized BMW center or bmwusa.com.

Premium Package	528i	535i	550i
Dakota Leather upholstery and door trim	○◇	○◇	●
Automatic-dimming interior rear-view mirror and exterior side-view mirrors	◇	◇	●
Interior Ambiance lighting	◇	◇	●
Integrated 3-button Universal garage-door opener	◇	◇	●

Premium Package II (Requires Premium Package)			
3-stage heated front seats	○△★◆	○△★◆	○△★◆
Enhanced Premium high-fidelity 16-speaker sound system with Digital Sound Processing (DSP), 2 subwoofers under the front seats and digital 9-channel amplifier with 600 watts of power	◆	◆	◆
iPod <sup>®</sup> and USB adapter (includes cable connector)	○◆	○◆	○◆
SIRIUS Satellite Radio with one-year subscription (please visit your authorized BMW center for details on services and equipment)	○◆	○◆	○◆
Park Distance Control (front and rear)	○◆	○◆	●
Manual rear side-window sunshades and power rear-window sunshade	○◆	○◆	○◆
Hard drive-based Navigation system with voice feedback, Voice command system and Real Time Traffic Information	○◆	○◆	●
Rear-view Camera (528i and 535i require Park Distance Control)	○◆	○◆	○◆

Sport Package			
Increased top-speed limiter	□	□	□
V Spoke (Style 328) 18 x 8.0 light alloy wheels, 245/45 run-flat performance tires <sup>9</sup>	□		
V Spoke (Style 331) 19 x 8.5 front, 19 x 9.0 rear light alloy wheels; 245/40 front, 275/35 rear run-flat performance tires <sup>9</sup>		□	
W Spoke (Style 332) 19 x 8.5 front; 19 x 9.0 rear light alloy wheels; 245/40 front, 275/35 rear run-flat performance tires <sup>9</sup>			□
Shadowline exterior trim	□	□	□
18-way power Multi-contour front seats; includes articulated upper backrest, 4-way lumbar support, passenger's-seat memory, Active Head Restraints, and adjustable thigh support	○△□	○△□	○△□
3-spoke leather-wrapped multi-function sport steering wheel with controls for audio system, cruise control, and Bluetooth <sup>11</sup> ; wireless communication for hands-free mobile phone (if so equipped) <sup>10</sup>	□	□	□



Weight		528i	535i	550i
Unladen weight				
Manual transmission	lbs	—	4056	4310
Automatic transmission	lbs	3814	4090	4343
Weight distribution, front/rear				
Manual transmission	%	—	50.8/49.2	52.4/47.6
Automatic transmission	%	50.0/50.0	50.9/49.1	52.8/47.2

Engine				
Type/cylinders/valves per cylinder		Inline 6/4	TwinPower Turbo Inline 6/4	TwinPower Turbo V-8/4
Displacement	cc	2996	2979	4395
Bore/stroke	inch	3.30/3.50	3.30/3.50	3.50/3.50
Nominal output/rpm	hp	240/6600	300/5800	400/5500-6400
Max. torque/rpm	lb-ft	230/2600-3000	300/1200-5000	450/1750-4500
Compression ratio	:1	10.7	10.2	10.0

Transmission				
Manual gear ratios	I/II/III:1	—	4.11/2.32/1.54	5.08/2.80/1.78
	IV/V/VI/R:1	—	1.18/1.00/0.85/3.73	1.26/1.00/0.84/4.61
Final drive ratio			3.23	3.08
Automatic gear ratios	I/II/III/IV:1	4.71/3.14/2.11/1.67	4.71/3.14/2.11/1.67	4.71/3.14/2.11/1.67
	V/VI/VII/VIII/R:1	1.29/1.00/0.84/0.67/3.30	1.29/1.00/0.84/0.67/3.30	1.29/1.00/0.84/0.67/3.30
Final drive ratio	:1	3.39	3.08	2.81

Performance				
Top speed <sup>1</sup>	mph	130 [150]	130 [155]	130 [155]
Acceleration 0-60 <sup>2</sup>				
Manual transmission	sec	—	5.7	5.0
Automatic transmission	sec	6.6	5.7	5.0
Drag coefficient	C <sub>d</sub>	0.28	0.29	0.30

Fuel consumption <sup>3</sup>				
Manual transmission				
City/highway	mpg	—	19/28	15/22
Automatic transmission				
City/highway	mpg	TBD/TBD	20/29	17/25
Fuel tank capacity, approx.	gal	18.4	18.4	18.4

Figures in [ ] apply to vehicles with Sport Package.

<sup>1</sup> Top speed limited electronically.

<sup>2</sup> BMW AG test results. Actual acceleration results may vary, depending on specification of vehicle, road and environmental conditions; testing procedures and driving style. These results should be used for comparison only and verification should not be attempted on public roads. BMW urges you to obey all posted speed laws and always wear safety belts.

<sup>3</sup> EPA-estimated figures are for comparison purposes only. Your actual mileage will vary, depending on speed, driving habits, trip length and driving conditions; actual mileage may be lower.

Wheels		528i	535i	550i
Tire dimensions		225/55	245/45	245/45
Wheel dimensions		17 x 8.0	18 x 8.0	18 x 8.0
Material		light alloy	light alloy	light alloy

Ventilated disc brakes				
Front/diameter	inch	13.7 x 1.2	13.7 x 1.4	14.7 x 1.4
Rear/diameter	inch	13.6 x 0.8	13.6 x 0.9	14.6 x 0.9
Steering type/steering ratio	:1	Rack & Pinion/17	Rack & Pinion/17	Rack & Pinion/17

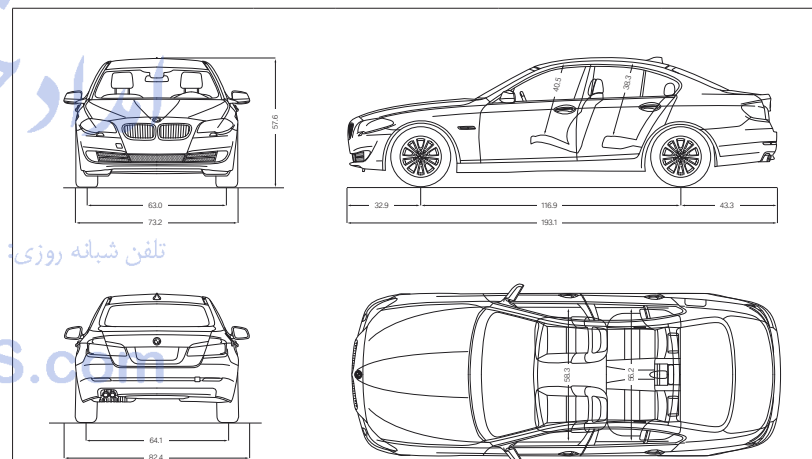

All dimensions in the technical drawings are shown in inches.

U.S. Importer: BMW of North America, LLC, Woodcliff Lake, NJ 07677. All illustrations and specifications contained in this brochure are based on the latest product information available at the time of printing. BMW reserves the right to make changes at any time, without notice, in colors, materials, equipment, specifications and models. BMW may, subject to legal requirements, determine the Model Year designation of its vehicles. The Model Year designation on any particular model may be longer or shorter than 12 months. Some vehicles pictured may contain non-U.S. equipment. Some models may be shown with optional equipment. While BMW NA makes all reasonable efforts to provide accurate information in this brochure, there is no guarantee or warranty of accuracy. Furthermore, we do not assume any liability for the accuracy or completeness of information presented. This brochure shall not be used or relied upon as a substitute for information that is available from your BMW center. Further information can be obtained from your authorized BMW center or [bmwnusa.com](http://bmwnusa.com).

©2010 BMW of North America, LLC. Not to be reproduced wholly or in part without written permission of BMW NA. The BMW name, model names and logo are registered trademarks. The Bluetooth word mark and logos are owned by the Bluetooth SIG, Inc. and any use of such marks by BMW is under license. iPhone and iPod are registered trademarks of Apple Inc. Other trademarks and trade names are the property of their respective owners.

**We constantly monitor your BMW's needs – so you don't have to.** Tracking mountain switchbacks, the last thing you should be thinking about is the state of your brake pads. Thanks to BMW's integrated on-board diagnostics system, you will always know exactly when the next service is due, and what work will be required.

Condition-Based Service (CBS) measures the condition of key parts that are subject to wear and tear. It also tracks fluid levels and monitors your BMW's time- and mileage-dependent service requirements. Using this data, the Info

Display in the cockpit automatically alerts you in advance whenever any part of your vehicle will require servicing. You can also use the iDrive Control Display to find out which components will need to be serviced, and when.

When combined with TeleService – the innovative telematics service included with the standard BMW Assist™ Safety Plan<sup>1</sup> – the CBS-collected data is automatically transmitted to your BMW center, which then contacts you to set up a service appointment. And because they use only **Original BMW Parts**, you can rely on expert fit and long-lasting BMW quality.

## JOY IS THE FEELING OF BEING LOOKED AFTER BY THE BEST. BMW SERVICE FOR YOUR BMW.

**BMW Ultimate Service.™** At BMW, we believe that a premium ownership experience should feature performance and luxury, as well as safety and convenience. We believe you should be able to drive a BMW to its potential, while enjoying peace of mind and reduced cost of ownership. That's the idea behind BMW Ultimate Service: a suite of comprehensive programs and services that are included with every new vehicle. The New Vehicle/SAV Limited Warranty, the BMW Maintenance Program, Roadside Assistance and BMW Assist with TeleService come standard. BMW Ultimate Service starts with the **New Vehicle/SAV Limited Warranty**, providing you with coverage for the first four years or 50,000 miles, whichever comes first. Additionally, you have 12-year, unlimited-mileage warranty protection against corrosion and rust perforation.<sup>2</sup> **BMW Maintenance Program** is one of the most comprehensive maintenance programs in its class. We cover all factory-recommended maintenance during the New Vehicle/SAV Limited Warranty coverage period. This includes scheduled oil services and inspections. Also covered is the replacement of items that are subject to normal wear and tear, such as brake pads, wiper blade inserts and engine drive belts.<sup>3</sup> And,

thanks to BMW's advanced engineering, most owners enjoy a well-balanced maintenance schedule, with flexible routine service intervals that can save you time. When your vehicle requires attention, your authorized BMW center ensures that it receives only genuine BMW parts – or your assurance of exacting quality standards.

**BMW Roadside Assistance** is provided free of charge for the first four years – with no mileage limit. Call **1-800-332-4BMW (4269)** for friendly on-the-road help, 24/7, anywhere in the United States, Canada and Puerto Rico. This includes everything from flat-tire changes, emergency gasoline and lock-out service, to towing, alternative transportation and even trip-interruption benefits. This service also provides valuable trip-routing advice.

BMW's unique **TeleService**, included in the BMW Assist Safety Plan, continually monitors specific parts that are subject to wear and tear – including the engine oil, micro-filter, spark plugs, brake linings and various fluids – as well as services that require attention at regular intervals, such as vehicle service inspections. This data is automatically transmitted to your BMW center, which will then call you to schedule a service appointment. You don't have to keep track of when your vehicle requires routine maintenance. An added benefit: any needed maintenance service parts will already be on hand, so your BMW is serviced and returned to you as quickly as possible.

as well as Bloomberg's stock indices and the powerful reach of the Google Maps database – delivered to the iDrive display right inside your vehicle.

BMW's unique **TeleService**, included in the BMW Assist Safety Plan, continually monitors specific parts that are subject to wear and tear – including the engine oil, micro-filter, spark plugs, brake linings and various fluids – as well as services that require attention at regular intervals, such as vehicle service inspections. This data is automatically transmitted to your BMW center, which will then call you to schedule a service appointment. You don't have to keep track of when your vehicle requires routine maintenance. An added benefit: any needed maintenance service parts will already be on hand, so your BMW is serviced and returned to you as quickly as possible.

For more details on BMW Ultimate Service, visit your authorized BMW center or log on to [bmwusa.com/ultimateservice](http://bmwusa.com/ultimateservice).

## THE MOST EXCITING PLACE IN AMERICA TO DRIVE THE ALL-NEW 5 SERIES SEDAN.

### The BMW Performance Center in Spartanburg, SC.

Just beyond the foothills of the Carolinas' Blue Ridge Mountains lies the \$12 million BMW Performance Center. This sprawling, modern complex houses the world-famous BMW Performance Driving School, as well as the Zentrum Museum, BMW Boutique, BMW Delivery Center, and a Corporate Conference Center. Nearby is BMW's only manufacturing facility in the U.S., where models, such as the SAV<sup>®</sup>, are built for export worldwide. It's a unique place where BMW enthusiasts can spend days – or, in the surrounding area, an entire vacation.



## JOY COMES IN MANY FORMS.

### BMW Virtual Center.

If you get the sudden urge to shop for a BMW but your BMW center is closed, there's good news – the BMW Virtual Center is open 24 hours a day! Log on to [bmwusa.com](http://bmwusa.com), and in the top navigation bar, choose "Build Your Own," and then the model that interests you. Configure the BMW of your dreams, and see what the monthly payments would be. You can even send the specifications to your authorized BMW center, apply for financing, or request a test drive – all online!

### BMW Financial Services.

Arranging to buy or lease a BMW is easier than you may think. Your authorized BMW center offers leasing and financing to suit your personal needs through BMW Financial Services.<sup>4</sup> Start the process at our website, where you can build your "dream vehicle," get an estimate on a monthly lease or financing payment, submit a credit application to BMW Financial Services – and get approval – all online! To find out how BMW Financial Services can help put you behind the wheel of your favorite BMW model, log on to [bmwusa.com/fs](http://bmwusa.com/fs) or call, toll-free, **1-800-578-5000**.

### BMW Publications in "Media Gallery & Library."

Sent to new owners and lessees several times a year, **BMW Magazine** is a fascinating view of the latest events and products in the world of BMW, including personality profiles, travel reviews, and the latest BMW technologies. You can read articles from **BMW Magazine** on the BMW website at [bmwusa.com](http://bmwusa.com) under the "Media Gallery & Library" heading, found in the "Experience" section. Here, you can also view featured videos and images, read recent news articles, and download BMW wallpapers. While you're there, check out the "News Feed" area to enjoy articles from **Inside Track**. For more information, call Customer Assistance at **1-800-334-4BMW (4269)** or visit BMW online at [bmwusa.com](http://bmwusa.com).

The new **BMW Welt** ("BMW World") delivery and brand-experience center in Munich is bold proof of BMW's passion for design. When you take advantage of the BMW European Delivery Program,<sup>5</sup> this is where you will meet your new BMW – in a personalized process that is highly dramatic and totally unforgettable. (You might also realize substantial savings that just may pay for your trip.) While you're there, marvel at the historic BMWs in the Museum; learn about our engineers' newest innovations in the Technology and Design Atelier; and take a tour of the plant to experience firsthand the state-of-the-art methods used to create a BMW. Then comes the unique experience of driving your new BMW on the roads it was designed for. To learn more, visit [bmwusa.com/europeandelivery](http://bmwusa.com/europeandelivery).

<sup>1</sup> The BMW Assist and Bluetooth Hands-free Calling system with 4 years of Safety Plan services is standard. In order to receive BMW Assist services, a subscriber agreement must be completed and the vehicle ignition must be turned on (except for Door Unlock and Stolen Vehicle Recovery), battery charged and connected and vehicle's electrical system operational; services may be limited to certain geographic areas. Call toll-free **1-888-333-6118**, go to [bmwassist.com](http://bmwassist.com), or visit your BMW center for additional program details. Services are subject to the terms and conditions of your subscriber agreement.

<sup>2</sup> See your authorized BMW center for details on these limited warranties.

<sup>3</sup> The BMW Maintenance Program covers factory-recommended maintenance services as determined by the Service Interval Indicator for all new eligible MY 2004 and later BMW vehicles. Specific additional items that need replacement due to normal wear and tear are also covered. The maintenance coverage period is for the first 4 years or 50,000 miles, whichever comes first. Exclusions from coverage include: gasoline, gasoline additives, windshield washer fluid and additives, battery, tires, wheels, wheel alignment and tire balancing. All work must be performed by an authorized BMW center. See the Service and Warranty Information booklet for specific terms, conditions and limitations. Further information can also be obtained from your authorized BMW center.

<sup>4</sup> Requires BMW Assist Safety Plan subscription. Services are subject to the terms and conditions of your subscriber agreement. Please go to [bmwassist.com](http://bmwassist.com) for additional details on the optional Convenience Plan.

<sup>5</sup> Subject to credit approval and other terms and conditions.

<sup>6</sup> Not all models available for BMW European Delivery Program. Please go to [bmwusa.com](http://bmwusa.com) or visit your authorized BMW center for details.

### BMW Performance Driving School.

Whether you've been driving for decades or just got your learner's permit, we can help take your driving skills to the next level. Behind the wheel of our new BMWs and under the expert guidance of professional driving instructors, you'll hone your driving skills on a versatile driving course – 1.7 miles of asphalt that can be configured in a multitude of ways. In One- and Two-Day Schools you can tackle the skid pad, slalom course and water walls. The BMW Performance Driving School is about control and pushing a BMW to its limits – and yours.

### BMW Performance Center Delivery.

You'll always remember the fun of taking delivery of your new BMW – with BMW Performance Center Delivery. After enjoying dinner and an overnight stay at a first-class hotel, we'll take you and your companion to the Performance Center where a Product Specialist will give you an in-depth introduction to your new BMW. Then at the Performance Driving School, you'll get tips from a professional driving instructor as you explore the dynamic capabilities of a similar model. It's exciting, it's enlightening – and it's all compliments of BMW with your new vehicle.

To learn more about the BMW Performance Center, call **888-345-4269** or visit [bmwusa.com/performancecenter](http://bmwusa.com/performancecenter).

More about BMW



bmwusa.com  
1-800-334-4BMW

The Ultimate  
Driving Machine®



FarmaSOS.com

#### **BMW and the environment.**

BMW is a strong proponent of the environment and social responsibility. It is important to manage the earth's resources responsibly, and not jeopardize the needs of future generations. That is why BMW makes vehicles that minimize adverse environmental impact, from production (pollution prevention and waste minimization at the plant) through owner use (low emissions) to eventual disposal (easy drainability of all fluid-related components and easy neutralization of all pyrotechnic devices).

This effort has been recognized worldwide and, as a result, we are pleased to have received numerous environmental honors. In the U.S., for example, the Environmental Protection Agency accepted BMW's Spartanburg, SC production and manufacturing facility as a charter member of the agency's National Environmental Performance Track. Internationally, BMW AG – the parent company of both BMW of North America and BMW Manufacturing Co., Spartanburg, SC – was the first automotive company to be represented on the Dow Jones Sustainability Group Index, and has remained on the Index ever since. At BMW, we strive for high performance in everything we do.

**BMW recommends** 