

BMW X3  
Sports Activity  
Vehicle®

X3 xDrive28i  
X3 xDrive35i



The Ultimate  
Driving Machine®



تلفن شبانه روزی: ۰۲۱-۸۸۸۶۲۰۸۵

FarmaSOS.com

# THE BMW X3.

MAKE EVERY DAY LESS EVERYDAY.

**BMW EfficientDynamics**

Less emissions. More driving pleasure.

# LIFE IS A JOURNEY THAT NEVER ENDS.

**BMW EfficientDynamics**  
Less emissions. More driving pleasure.

Uniting sporty elegance with pure power and extreme efficiency, the BMW X3 opens up a whole new world of possibilities. The X3 xDrive35i with its 3.0-liter TwinPower Turbo inline six-cylinder engine delivers 300 horsepower for quick acceleration with impressive fuel economy. Discover new horizons at [bmwusa.com/X3](http://bmwusa.com/X3).





## The BMW X3

### VERSATILITY NEVER LOOKED BETTER.

- 08 **Exterior**  
Attention-getting from every angle.
- 10 **Performance**  
Inspiring driving, responsive handling.
- 12 **BMW EfficientDynamics**  
Always thinking ahead.
- 14 **Customizing technologies**  
Bumper-to-bumper innovation.
- 16 **Versatility**  
Built for whatever lies ahead.
- 18 **In demand**  
Interview with exterior designer Erik Goplen.
- 20 **Interior and BMW ConnectedDrive**  
One-of-a-kind, down to the last detail.
- 22 **Quality**  
Nothing but the best.
- 26 **Cargo capacity**  
A multi-faceted interior space.

[bmwusa.com/X3](http://bmwusa.com/X3)

## Technology

### INNOVATION MEETS INSPIRATION.

- 28 **BMW EfficientDynamics**  
Technology for reduced fuel consumption and emissions.
- 30 **Engines**  
Maximum performance from minimized fuel consumption.
- 32 **Chassis and safety**  
Advanced systems for greater safety and driving pleasure.
- 36 **BMW ConnectedDrive**  
A suite of integrated features for greater convenience, infotainment and safety.
- 40 **8-speed STEPTRONIC automatic transmission**  
Setting the standard for comfort and efficiency.

## Equipment

### FILLED WITH WHAT MOVES YOU.

- 42 **Equipment combinations**
- 44 **M Sport Package**
- 46 **Dream it. Build it. Drive it.**
- 48 **Exterior colors**
- 49 **Upholstery colors and materials**
- 50 **Interior trims**
- 51 **Recommended color combinations**
- 52 **Equipment features and options**
- 58 **X-Line exterior trim**
- 59 **Original BMW Accessories**

[bmwusa.com/byo](http://bmwusa.com/byo)

## Overview

### SPECIFICATIONS AND SERVICES.

- 60 **Build Your Own Technical data**
- 61 **Technical data**
- 64 **BMW Services**  
Exclusive offers for BMW customers.

## Editorial

# AUTOMOTIVE LOVE AT FIRST SIGHT.

There are few vehicles that connect you to the driving experience in a truly satisfying way. That's because there are few vehicles that can deliver on all counts – whether you're on a snowy excursion with friends, heading toward soccer practice in muddy conditions, or merely tackling the thrilling corners of a challenging stretch of secluded tarmac. Real life is dynamic, unpredictable and exciting – and requires a vehicle that can respond accordingly. Here's the perfect answer: the BMW X3. An exuberant take on BMW's original Sports Activity Vehicle,<sup>®</sup> the BMW X3 plots a course for modern-day adventurers. Its rugged and powerful exterior is also graceful and agile. Its interior, which caters to the driver's needs, is also elegantly designed with comfort in mind. And it offers generous helpings of horsepower, available in two flavors. It's not enough to simply read about the BMW X3. This is a vehicle that must be driven to be truly savored. Welcome to driving bliss.

[bmwusa.com/X3](http://bmwusa.com/X3)

امداد خودرو فارما  
تلفن شماره روزی: ۰۸۵-۱۸۸۶۲۰۸۵  
FarmaSOS.com  
[bmwusa.com](http://bmwusa.com)

For exclusive BMW photos, behind-the-scenes videos, and the latest BMW news:

Like us on Facebook:  
[facebook.com/bmwusa](https://facebook.com/bmwusa)

Follow us on Twitter:  
[twitter.com/bmwusa](https://twitter.com/bmwusa)

Find us on [youtube.com/bmwusa](https://youtube.com/bmwusa)

Follow us on [instagram.com/bmwusa](https://instagram.com/bmwusa)





# BLISS, BUILT TO ORDER.

There's no stopping it: once you've been inside the BMW X3, you realize just how far the original Sports Activity Vehicle® has come. Welcome to driving bliss – with a compelling X factor: the ability to custom-order The Ultimate Driving Machine® of your dreams.

امداد خود را

تلفن شبانه روزی: ۰۸۵

masos.com



# PRECISION ENGINEERING MEETS PERSONALIZED ELEGANCE.

Rugged and agile, yet sophisticated and sporty – the BMW X3 arrives ready to alter your preconceptions. The exterior reflects this balanced vision: a dynamic silhouette, an aggressively styled front end, a large titanium kidney grille, chrome tailpipe finishers and a bold character line on either side directly communicate the BMW X3's personality. This commanding presence is further enhanced with LED Corona headlight-rings that double as Daytime Running Lights. And since it is built at BMW's Spartanburg, South Carolina, manufacturing plant, when you factory-order your vehicle, you'll have unprecedented levels of control over its appearance. Get ready for a one-of-a-kind driving experience.

[bmwusa.com/X3](http://bmwusa.com/X3)



**WITH JUST ONE LOOK, IT WILL TANTALIZE. WITH JUST ONE DRIVE, IT WILL CAPTIVATE. THE BMW X3.**



Get the latest information on BMW standard and optional features, packages and technical specifications. Visit [bmwusa.com](http://bmwusa.com), select the BMW model of your choice, and click on "Features & Specs."



**THE BMW X3 GETS YOU THERE.  
IT ALSO SIMPLY GETS YOU.**

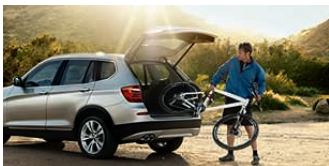

## **RESPONDS TO THE ROAD – AND TO YOUR NEEDS.**

When it comes to driving technologies, the BMW X3 starts where others leave off. The most recent iteration of xDrive intelligent all-wheel drive imbues the BMW X3 with confidence-boosting grip on nearly any road for optimum traction, regardless of driving conditions. Two powerful yet fuel-efficient engine options give you the best of both worlds. And wherever you're headed, you'll have everything you need with you – thanks to abundant cabin and storage space, flexible split-folding rear seats and available roof rails. Discover the true capabilities of an all-wheel-drive vehicle – as only BMW could deliver.

Get the latest information on BMW standard and optional features, packages and technical specifications. Visit [bmwusa.com](http://bmwusa.com), select the BMW model of your choice, and click on "Features & Specs."





**A TRULY REWARDING DRIVE  
SHOULD BE ABOUT MORE THAN  
JUST PLEASING THE DRIVER.**

From the ground up, the BMW X3 delivers all the right moves while creating as little waste and as few emissions as possible. Two fuel-efficient TwinPower Turbo engine options deliver ample amounts of pure horsepower while sipping gas. The lightweight engine in both models is mated to a standard 8-speed automatic transmission with ideally spaced gear ratios for smoother, cleaner shifting that also contributes to a higher mpg rating. Even the BMW X3's next-generation xDrive intelligent all-wheel-drive system offers faster response and improved handling characteristics. But efficiency doesn't start and stop merely with the powertrain. Auto Start-Stop technology can actually turn the engine off when you're at a light for increased fuel economy. In every BMW model, innovative resource-saving technologies breathe new and sustainable life into ultimate driving. Take, for example, Brake Energy Regeneration: the battery actually captures the kinetic energy otherwise wasted during coasting and braking, and uses it to help charge the battery. Electric Power Steering conserves fuel by using the battery's charge instead of relying on the engine's output to operate the power steering system. The extensive use of lightweight components also reduces the amount of fuel the BMW X3 uses to chase after driving joy. The net result of these EfficientDynamics technologies: reduced emissions and less waste – helping to save fuel costs while protecting the resources of the planet. While competitors build all-wheel-drive vehicles designed only to conquer the elements, the BMW X3 is designed to also live in harmony with them.

Get the latest information on BMW standard and optional features, packages and technical specifications. Visit [bmwusa.com](http://bmwusa.com), select the BMW model of your choice, and click on "Features & Specs."

**BMW EFFICIENT DYNAMICS:  
CONSERVING RESOURCES  
WHILE MAXIMIZING OUTPUT.**

A mandate that has long guided the engineering and design principles of BMW, EfficientDynamics leads us to new standards and processes that make the most of every ounce of BMW power. From lightweight construction to fuel-efficient engines to advanced energy-saving technologies, EfficientDynamics ensures the future of driving joy will continue – as it does so spectacularly in the BMW X3.

[bmwusa.com/EfficientDynamics](http://bmwusa.com/EfficientDynamics)

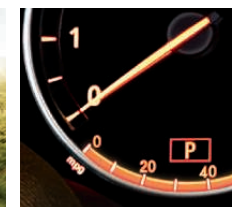



آردا خودرو کارنا  
 تلف شیکه روزن: ۰۸۵ ۷۶۲ ۸۷۱  
 FarmaSOS.com

## TECHNOLOGY, NOT MAGIC.

It takes an extraordinary vehicle to cater to virtually every driver's every whim. The BMW X3 goes above and beyond the call of duty, with a host of available driving technologies that make life behind the wheel that much more enjoyable. In addition to traction-enhancing xDrive all-wheel drive, the Driving Dynamics Control feature adjusts the driving characteristics to your liking when you choose one of three settings: ECO PRO, COMFORT, or SPORT. Available Variable Sport Steering offers improved handling for high-performance driving situations. Performance Control, which is included in the Dynamic Handling Package along with Dynamic Damper Control and Variable Sport Steering, maintains a rear-wheel-drive-oriented torque split for sportier handling and responsiveness. And if you're looking for even more track-inspired fun, choose the 8-speed Sport Automatic transmission with Sport and Manual shifting modes, as well as steering wheel-mounted paddle shifters. The BMW X3 is designed to help you – actually, to encourage you – to test your driving limits.<sup>1</sup>

[bmwusa.com/X3](http://bmwusa.com/X3)

## DYNAMIC DAMPING CONTROL: FEEL THE ROAD BENEATH YOU – OR NOT.

<sup>1</sup> BMW urges you to obey all posted speed laws and always wear safety belts.

Get the latest information on BMW standard and optional features, packages and technical specifications. Visit [bmwusa.com](http://bmwusa.com), select the BMW model of your choice, and click on "Features & Specs."







**THE BMW X3 HAS A PLACE FOR EVERYTHING – AND PUTS EVERYTHING IN ITS RIGHT PLACE.**



## **A REAL TEAM PLAYER.**

Versatility: that's the appeal of the BMW X3's interior. No space is squandered, so nothing is squeezed in – just loads of flexible space for passengers and cargo. Up front, its updated center console, handily located cupholders and expanded door pockets help keep everything organized, secure and within easy grasp. In back is the largest cargo space in its class. Stick with standard 60/40 rear split-folding seats, or for even greater storage flexibility, upgrade to 40/20/40 split-folding seats. Enjoy the push-button ease of a power tailgate; add a retractable cargo net and roof rails for even more organized carrying capacity. When it comes to sheer convenience, the BMW X3 is a hands-down winner.

Get the latest information on BMW standard and optional features, packages and technical specifications. Visit [bmwusa.com](http://bmwusa.com), select the BMW model of your choice, and click on "Features & Specs."

# AN ART OBJECT WITH AN ALL-WHEEL-DRIVE SOUL.

The BMW X3's look harkens back to some classic BMW X touchpoints, while offering some intriguing new variations on a theme. Erik Goplen, automotive designer at BMW Group DesignworksUSA, provides the lowdown on some of the highlights of the BMW X3's design.



**Mr. Goplen, for three years you worked on the exterior design of the BMW X3. What kind of impression did you hope to make with this design?**

The BMW X3 needed to be instantly recognizable in two ways: first, as a member of the BMW SAV® family and second, as the successor to the previous BMW X3. Every BMW SAV represents powerful agility and a very sturdy presence on the road. We generated this impression through the use of typical SAV proportions, like the upright kidney grilles, shortened hood and steeply slanted rear window. We also wanted to make the BMW X3 appear more adult, as a logical "next step."



**What tells the viewer that they're looking at the BMW X3?**

First of all, the size – it's been increased over its predecessor, with greater presence and appeal. Then, of course, the typical BMW SAV characteristics, as well as similarities this BMW X3 shares with the previous one. The classic "three-eyed face" of the BMW SAV family is very distinctive – the double round headlights and the foglights, which are situated particularly high up and toward the edges of the vehicle's front end. From the side, you can see that the Hofmeister kink is positioned higher than it is on other models, which lends the windows a special SAV aesthetic. The rear lights are still L-shape and, when together with the Xenon Headlights, they're very much in keeping with BMW style.



**What other distinguishing BMW features does the BMW X3 have?**

Well, for example, take the typical double round headlights. They feature a clear and simplified design and are topped off by distinctive chrome-color "eyebrows." They give the vehicle a more determined look. Plus, of course, there are the classic convex-concave surfaces, which create a shimmering interplay between light and shadow.



**BMW's are famous for their carefully crafted details. Which parts are you particularly fond of?**

One particularly striking design element of this BMW X3 is its clear side contours, which curve upwards sharply after the front wheel arch, and carry on through to the rear lights. An additional contour runs along the rear wheel arch to further emphasize the vehicle's powerful agility. Details, such as the side indicators, were also refined – in this case, through integration in specially molded casings.

**I found the unusual contours on the hood particularly eye-catching. What's your take on it?**

The hood is a real work of art, as far as modern metalworking techniques are concerned. It makes a really strong statement; you could just about hang it on your wall at home! The strongly defined lines really bring out the sporty and robust appearance of the front end – they're a distinguishing feature of all BMW SAVs.



فارما سوس

تلفن شبانه روزی: ۰۲۱-۸۸۸۶۲۰۸۵

FarmaSOS.com

## TAKE CONTROL OF YOUR INNER WORLD.

Soothing and energizing, replete with elegant accents and driver-centric technologies: the BMW X3's command center connects you to more than just the road. The Driving Dynamics Control with ECO PRO tailors engine-throttle response, transmission shift characteristics and power-steering assist levels. When the X3 is equipped with Dynamic Damping Control, you can even choose the level of road feel from the suspension by selecting the COMFORT or SPORT modes. While en route, the Head-up Display projects crucial driving information onto the windshield at eye level. Use the Navigation system to plot your trip, with advanced mapping and local searches powered by Google Maps,™ shown on the easy-to-view on-board Display screen. The comprehensive BMW ConnectedDrive system, including available features such as BMW Assist eCall,™ Remote Services, BMW Online, BMW Apps, Concierge and more, offers a unique and seamless array of safety, convenience and infotainment features. Access phone numbers, calendars and to-do lists using your iDrive Controller. Play music wirelessly from any compatible music player or Bluetooth® mobile phone<sup>1</sup> through your speakers. Connect your iPod® or iPhone® using your USB cable, and the cover art of your favorite albums pops up on your Display screen. When you pair the on-board Navigation system with a compatible smartphone,<sup>1</sup> you can display text messages on your iDrive screen or have them read aloud. The BMW X3 is packed full of technology that integrates with both your lifestyle and your driving style.

[bmwusa.com/connecteddrive](http://bmwusa.com/connecteddrive)



<sup>1</sup> Check for a list of tested mobile phones at your authorized BMW center or [bmwusa.com/bluetooth](http://bmwusa.com/bluetooth).

Get the latest information on BMW standard and optional features, packages and technical specifications. Visit [bmwusa.com](http://bmwusa.com), select the BMW model of your choice, and click on "Features & Specs."

**A LOGICAL EXTENSION  
OF YOUR DRIVING PASSION.**



## UP-FRONT ABOUT LUXURY.

Elegant, roomy and convenient: the BMW X3 offers front-seat occupants a spectacular window on the world outside. This quiet cabin is complemented by equally impressive amenities, such as eight-way power-adjustable seats clad in Nevada Leather upholstery with contrast stitching. And modern yet elegant trim options, including Brushed Aluminum and Finesse Wave Wood, offer luxurious highlights in eye-catching places, like at the doors and on the dash.

Get the latest information on BMW standard and optional features, packages and technical specifications. Visit [bmwusa.com](http://bmwusa.com), select the BMW model of your choice, and click on "Features & Specs."

تلفن شبانه روزی: ۰۲۱-۸۸۶۶۰۸۵

FarmaSOS.com



**LIKE AN EXPERT CHEF,  
THE BMW X3 DELIVERS  
ON BOTH SUBSTANCE  
AND STYLE.**

Rear-seat passengers, rejoice: the BMW X3 makes traveling even long distances a breeze. Comfort that comes with plenty of personal space – both legroom and headroom – is amplified by the Panoramic moonroof that lets in the sky. Sit back and relax while taking in shimmering hi-fi sounds produced by the premium audio system, complete with 16 upgraded speakers. The BMW X3 does its best to accommodate passengers, first and foremost. The split-folding rear seats – configured in a standard 60/40 style, or a 40/20/40 arrangement – ensure you can transport your friends and your gear in comfort and style.

Get the latest information on BMW standard and optional features, packages and technical specifications. Visit [bmwusa.com](http://bmwusa.com), select the BMW model of your choice, and click on "Features & Specs."



فارسا

تلفن شبانه روزی: ۰۲۱-۸۸۸۶۲۰۰

FarmaSOS.com



Nature enthusiasts can start planning their next camping or hiking adventure with friends – the generous luggage compartment makes light work of backpacks, hiking boots and walking poles. And the BMW xDrive all-wheel-drive system can help you scale even the steepest mountain roads.



Winter sports fans can store skis, snowboards and boots easily, as the rear seatbacks fold down in a 40/20/40 split. This folding system creates ample room in the rear for two adults plus the ski and snowboard bag.

## LET YOUR INSTINCTS LEAD YOU.

From sports enthusiasts to weekend hobbyists, the BMW X3 has the capacity to let you live your life. So no matter what you're into, you can put it into this Sports Activity Vehicle.<sup>®</sup>



Sporty types will look forward to the drive to weekly practice. Tall occupants will no longer have to deal with limited headspace and cramped knees. Water bottles can be stored in the door pockets and two energy drinks fit in the cup-holders next to the gear lever knob.

Get the latest information on BMW standard and optional features, packages and technical specifications. Visit [bmwusa.com](http://bmwusa.com), select the BMW model of your choice, and click on "Features & Specs."

۰۲۱-۸۸۶۲۰۸۵

FarmaSO

Dog owners will find it easy to chauffeur their four-legged friends to the park in the BMW X3. Fitted mats from the BMW Accessories line protect the loading area and rear seats from dirt and stains. A net separates the dogs in the luggage compartment from the passengers in the rear. And if your pooch prefers to travel in his crate, there's plenty of room for that, too. In the BMW X3, even large-scale transport is no sweat.



## BMW EfficientDynamics

Less emissions. More driving pleasure.

BMW was one of the first manufacturers to pursue the goal of efficient driving technologies, as part of a multi-award-winning sustainability strategy. BMW EfficientDynamics represents an acclaimed standard package of innovative technologies that reduce fuel consumption and emissions, while simultaneously enhancing dynamic performance. Since 1995 BMW has been able to reduce the CO<sub>2</sub> emissions of its entire fleet by approximately 30 percent, and intends to achieve a further 25 percent reduction by 2020.



## BMW EFFICIENT DYNAMICS – MAKING A LITTLE GO A LONG WAY.

Different paths to the same destination: unmistakable BMW driving pleasure. Under the umbrella of the BMW EfficientDynamics project, BMW is continuously developing innovative systems that will bring us closer to the goal of emissions-free mobility in the long term. This BMW program for more driving pleasure is based on several pillars:

**Eco-friendly technology.** The development of more efficient vehicles powered by conventional diesel and gasoline engines are continuing challenges. A comprehensive technology package enables the reduction of fuel consumption and emissions, while at the same time increasing power output and driving enjoyment. These advances are based on innovations such as BMW TwinPower Turbo technology, Brake Energy Regeneration, and many others.

**BMW ActiveHybrid.** With the BMW ActiveHybrid 3, BMW ActiveHybrid 5 and BMW ActiveHybrid 7, BMW has impressive hybrid production models in its range. All combine outstanding efficiency with superlative dynamic ability.

**BMW ActiveE.** Since 2011, there has been a new form of dynamism on the roads: the all-electric BMW ActiveE. It is manufactured in a small production run, as part of a pilot project. In this way, BMW is preparing the way for the emissions-free mobility of the future.

**BMW i.** The BMW i will launch two completely new vehicle concepts for sustainable mobility in an urban environment. Key features of the BMW i3 and BMW i8 concepts include the use of lightweight materials such as Carbon Fiber Reinforced Plastic (CFRP), electric drive systems, powerful battery technology and eco-friendly production methods. The BMW i3 will be on the road in late 2013 and the i8 in 2014; both are an important part of EfficientDynamics technologies.

[bmwactivatethefuture.com](http://bmwactivatethefuture.com)  
[bmw-i-usa.com](http://bmw-i-usa.com)

## AT A GLANCE: BMW EFFICIENT DYNAMICS FEATURES IN THE BMW X3.

**BMW TwinPower Turbo technology.** This innovative turbocharging technology efficiently reclaims the energy contained in exhaust gases, using a twin-scroll charger with a double-flow exhaust system.

**High Precision Direct Injection.** In this latest-generation direct fuel injection system, the piezo injectors are positioned very close to the spark plugs. They inject fuel at high pressure, with extreme precision for very efficient combustion.

**Double-VANOS valve timing.** BMW's VANOS valve timing system "steplessly" varies the points in the combustion cycle when valves open and close. Double-VANOS refers to the fact that it operates on both the intake and exhaust camshafts. Electronically controlled in response to engine speed, temperature and load, it reduces emissions, and enhances low- to medium-speed torque, as well as fuel efficiency.

**8-speed STEPTRONIC automatic transmission.** The particularly smooth gear shifts of the 8-speed automatic transmission produce greater engine efficiency at every speed. The result: a reduction in fuel consumption and more comfortable gear changes. Both driver and passengers enjoy a supremely comfortable drive, underscored by significantly reduced fuel consumption and emissions.

**Auto Start-Stop function.** An idling engine burns fuel unnecessarily. The Auto Start-Stop function enhances fuel efficiency by switching off the engine when the vehicle is not moving. (The intelligent electronics system first checks the battery charge level and calculates if other electric systems, such as the air conditioning or heated rear windshield, require more energy.) Once the foot brake is released the engine starts up again.

**Electric Power Steering.** In comparison with conventional, hydraulic steering systems, the electric power steering system uses energy only during actual steering maneuvers. When driving straight ahead, the electronic motor is inactive.

**Brake Energy Regeneration.** In vehicles with Brake Energy Regeneration, the alternator normally generates electricity only when the driver takes his or her foot off the accelerator or brake pedal. Kinetic energy that was previously unharmed is transformed into electrical energy, then fed into the battery. In this way, electricity is generated without consuming fuel.

# ENGINES THAT MAKE THE MOST OF EVERY OUNCE – AND GIVE BACK A THOUSANDFOLD.

Every BMW engine follows the tenets of EfficientDynamics: reliable power and torque with exceptional fuel efficiency. On paper, the two available engine options for the BMW X3 are impressive feats of advanced engineering; in person, however, both engines exhibit all the power and excitement that make the BMW X3 such a thrilling vehicle. Both engines – an inline six-cylinder and an inline four-cylinder – incorporate TwinPower Turbo technology that delivers award-winning performance and innovative BMW enhancements that help lower emissions and reduce waste.

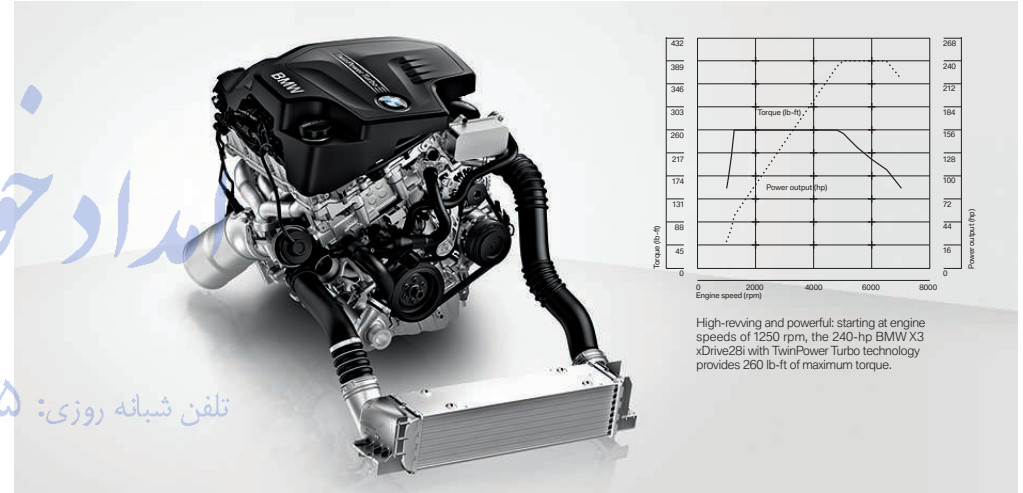
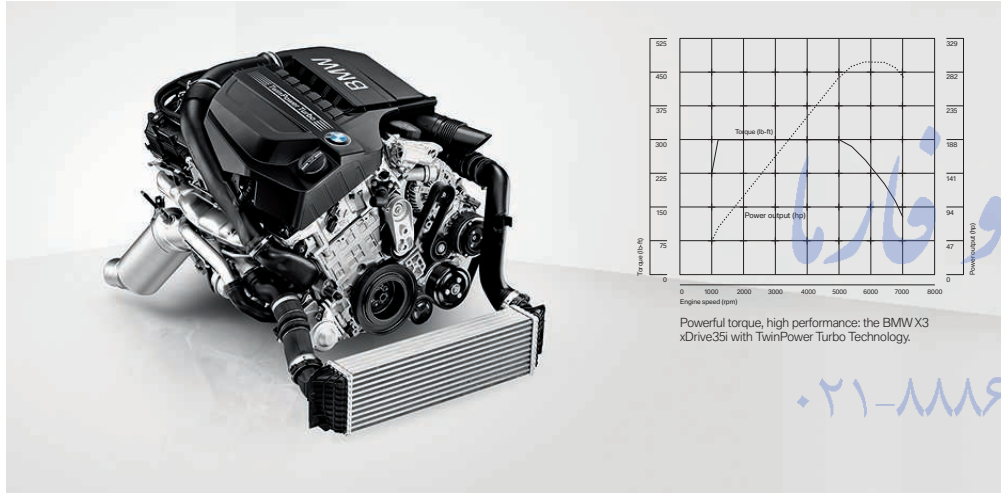

**BMW X3 xDrive35i.**  
BMW's award-winning 3.0-liter six-cylinder engine harnesses twin-scroll turbo technology in combination with direct fuel injection and Valvetronic. Output is an awe-inspiring 300 hp at 5800 rpm, with 300 lb-ft of pavement-punishing torque available from 1300 to 5000 rpm. But the same advanced technology that enables such impressive revs and pulse-raising power from this innovative engine also renders it one of the most fuel-efficient in its class. Now you can dominate the road while decreasing emissions.

[bmwusa.com/X3](http://bmwusa.com/X3)

FarmaSO

**BMW X3 xDrive28i.**  
Small is the next big idea in engines – namely, BMW's mighty inline four-cylinder TwinPower Turbo. Displacing just 2.0 liters, this 240-hp marvel generates 260 lb-ft of torque at just 1250 rpm, for potent thrust that kicks in right from the start and continues all the way up to 4800 rpm. Lightweight and smooth-running, it incorporates BMW's award-winning High Precision Direct Injection, Valvetronic and Double-VANOS technologies. Its dynamic performance is equaled by spectacular fuel efficiency, taking you further on every gallon of gas than did its six-cylinder predecessor.

تلفن شبانه روزی: ۰۲۱-۸۸۸۶۲۰۸۵





“THE ROAD CHANGES – BUT MY CONFIDENCE NEVER DOES.”

“For me, pure joy means being able to conquer the most challenging roads without compromising on safety. In the BMW X3, part of this involves innovative suspension technologies. BMW puts the best of its engineering into the BMW X3 so that I can confidently enjoy even the most demanding drives.”



## THE FEELING OF DRIVING THE BMW X3 IS SIMPLY INCREDIBLE. LIKE THE TECHNOLOGY BEHIND IT.

The formula sounds simple: a near-perfect 50/50 weight distribution between the front and rear axles. Yet few other makes have ever been able to duplicate this balance. BMW's engineers also have conjured similar triumphs in neutral steering properties, directional stability and traction control. A five-arm rear axle and wide track improve the responsiveness of the dampers, providing a more comfortable ride. Here are some more advanced technologies that combine to make the BMW X3 such a powerful presence on the road.

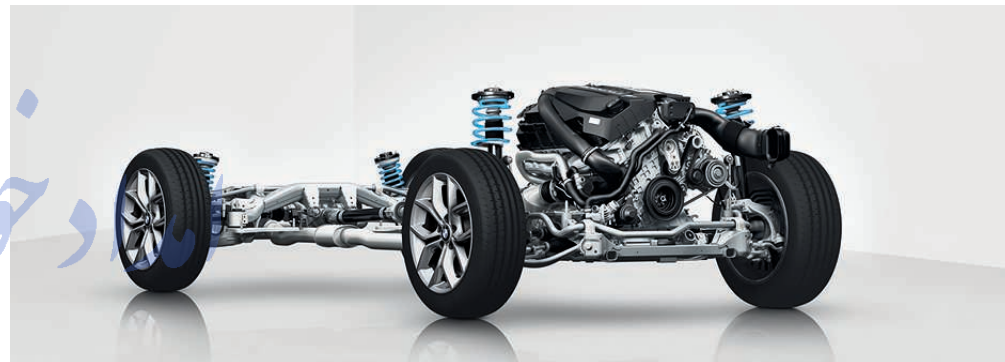

**xDrive.** Slippery leaves on wet roads, snow and ice – regardless of the road surface quality – the xDrive intelligent all-wheel-drive system and Dynamic Stability Control (DSC) give you road-gripping stability and outstanding traction. xDrive reacts immediately upon detecting over- or understeer, and employs an electronically controlled multi-plate clutch to redistribute drive power between axles in only fractions of a second.

**Dynamic Damping Control.** This available system adjusts the damping characteristics to suit the driving conditions and road quality. The damping changes contribute to a more stable-feeling ride.

**Variable Sport Steering.** This system continuously adjusts the steering ratio and steering force to suit the changing driving situation. The steering ratio is constantly adjusted depending on the steering movement. So you can enjoy increased agility on winding roads, more safety at higher speeds, and great flexibility when parking.

**Performance Control.** This system works together with xDrive, BMW's intelligent all-wheel-drive system, to improve handling in turns by dynamically intervening in specific engine and braking processes. Performance Control optimizes the management of engine power during turns by applying the brake slightly to the inside wheel while simultaneously increasing power to the outside wheel.

**Driving Dynamics Control including ECO PRO mode.** Choose from three settings: ECO PRO, COMFORT, and SPORT, to adjust engine-throttle response, transmission shift characteristics and power-steering assist. In addition, the traction control feature can be disengaged when driving on sand, gravel, or deep packed snow.

# ON THE ROAD: A FEELING OF UNPARALLELED SECURITY, THANKS TO A HOST OF BMW DRIVING TECHNOLOGIES.

For every potentially hazardous situation you face on the road, the BMW X3 answers with cutting-edge technologies. Superb handling and intelligent suspension control systems include Dynamic Stability Control with the innovative xDrive all-wheel-drive system. The BMW X3 integrates the latest active and passive safety features to deliver the most pleasure out of every drive. You'll feel secure and protected, no matter where your journey takes you.

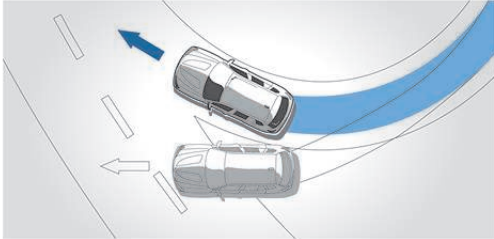

**Dynamic Stability Control (DSC)** provides remarkable tenacity on slippery road surfaces. If the system senses over- or understeer, it modulates engine power and can apply brakes individually to help keep the vehicle under control and going in the intended direction. In addition, the BMW X3 features Start-off Assistant, which acts to prevent the vehicle from rolling downhill for one-and-a-half seconds after the foot brake is released.

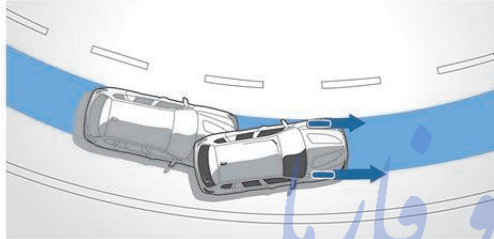

**Dynamic Traction Control (DTC)** is a sub-function of the DSC system. By raising the threshold for engine and braking interventions, it allows some additional wheelspin. This increases traction on loose surfaces, such as snow and gravel, and also allows the driver to enjoy an even sportier driving style. The DTC function is normally inactive, and must be switched on by pushing the DSC button.

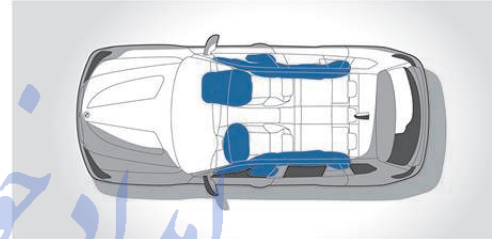

**Airbags**, designed to deploy only as needed in the event of a collision, are an integral part of the passive safety system in the BMW X3. Six airbags are installed for occupant protection: one front- and side-impact airbag each for the driver and front passenger, and continuous Head Protection System (HPS) airbags at the sides of the front and rear cabin to help protect all occupants.

Please note: These pictures of airbags are for illustrative purposes only. Depending upon the type of accident, none, some or all airbags may deploy.

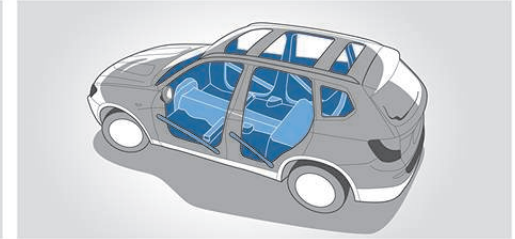

**Passenger cell with BMW's door-anchoring system** includes reinforcing bars with hook-like members within each door. In a serious side collision, the bars hook the door to the body, locking them together to make a more rigid passenger cell. When the pressure is released, the anchoring system is designed to disengage so that the doors can be opened (unless further damage from the impact prevents them from opening). An integrated rollover sensor provides additional passenger protection, while the BMW X3's hood has been redesigned to help protect pedestrians.

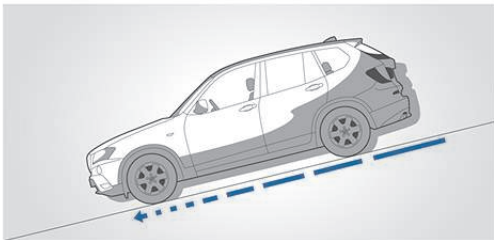

**Hill Descent Control (HDC)** helps the BMW X3 drive down steep hills without having to "ride the brake." By pressing the HDC button, the system keeps the BMW X3's speed under control automatically.

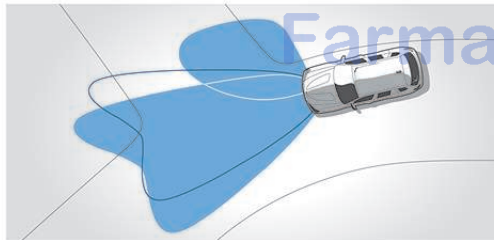

**Adaptive Headlights with LED Corona headlight-rings** automatically swivel to follow the curves of the road, enhancing visibility when driving at night. The system uses data from on-board sensors and the steering wheel angle to determine the vehicle's direction. The outer headlights then swivel accordingly, up to 15 degrees left or right. An auto-leveling feature adjusts the headlight beam's trajectory for varying passenger and cargo loads.



**BMW restraint system** for the driver and front passenger is comprised of three-point safety belts combined with safety-belt pretensioners that automatically tighten the lap and shoulder belts around front-seat occupants in the event of a severe frontal collision. Always wear your safety belt and always place children in the rear seat.

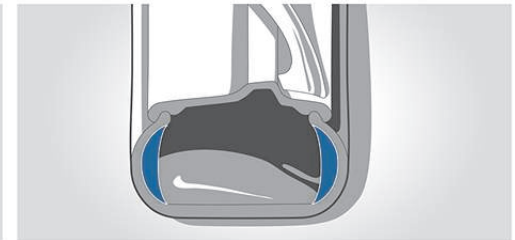

**Run-flat tires.** Thanks to reinforced sidewalls, run-flat tires maintain their shape and rim position even after suffering a complete loss of tire pressure.<sup>1</sup> They allow you to continue driving at a reduced speed until you reach a safe area to change a tire or wait for Roadside Assistance. The **Tire Pressure Monitor** alerts you when there is a drop in tire pressure; if the loss is severe, an acoustic warning is triggered.

<sup>1</sup> Please see the Owner's Manual for more information detailing allotted miles to travel and load weight rules.



## BMW ConnectedDrive In touch with your world.

Every day, our world is becoming increasingly networked. Many BMW drivers, however, are better connected than the rest, obtaining information on the road, communicating by phone or email, and always updated on the latest events. BMW ConnectedDrive encompasses all these services, including traffic features that allow BMW vehicles and their occupants to network with the outside world.



**Enhanced mobile networking.** The BMW Vision ConnectedDrive is a visionary Roadster whose amazing design goes far deeper than its dynamic, flowing lines. Three levels in the interior each symbolize a facet of BMW ConnectedDrive – Convenience, Infotainment and Safety; accompanying functions and controls are highlighted with different colored lights that illuminate information. An extraordinary synthesis of exterior and interior style and substance, the BMW Vision ConnectedDrive points the way to a mobile networking future. More information on this concept vehicle and further research projects can be found in the Future Lab.

[bmw.com/futurelab](http://bmw.com/futurelab)



## BMW CONNECTED DRIVE: CONVENIENCE, INFOTAINMENT AND SAFETY TECHNOLOGIES MEET IN ONE SUITE.

BMW drivers have long been accustomed to seamless communication between their vehicle and their personal and professional lives, such as making hands-free phone calls as well as requesting information or emergency assistance. Now, with the BMW ConnectedDrive concept, that idea has come to encompass all the services and innovative technologies that network BMW vehicles and their passengers with the outside world. BMW ConnectedDrive provides greater convenience, infotainment, safety and security.

**Convenience.** BMW ConnectedDrive innovations include helpful devices that make driving, navigating and parking much easier – and leave you much more relaxed.



**Park Distance Control (PDC)** facilitates parking and maneuvering in tight spaces. Sensors located in the front and rear bumpers help you judge how close you are to other vehicles and unseen objects: beeps sound a warning with progressively greater frequency as the bumper approaches the object, and become a constant tone when the distance is less than a foot. A visual graphic showing the distance of your vehicle to an obstacle is also shown in the iDrive Control Display.



**Head-up Display** projects important travel information, such as current speed, on the windshield directly in the driver's line of vision in a multi-color display. Directional arrows and corresponding travel information from the Navigation system and Check Control data can also be displayed.

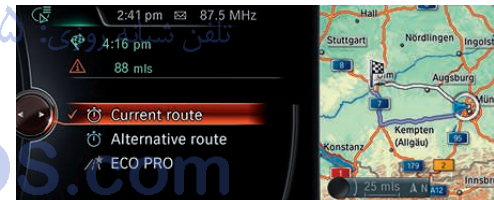

BMW's **Navigation system** uses Global Positioning System (GPS) satellites and data stored on an internal hard drive to guide you to your destination, which is displayed on a 8.8-inch high-resolution screen. The 200 GB hard-drive-based system features include 3-D daytime and nighttime maps, zoom and satellite images, travel planner, and an Assistance Window. It also offers Voice command for convenient, hands-free operation, and 20 GB of storage for your favorite media files. The available BMW Online option includes MyInfo, which allows Google Maps™ destinations to be sent to your vehicle.



**Rear-view Camera with Top View** clearly shows the rear and side areas of the vehicle on the Control Display. Interactive "track" lines indicate whether a parking space is large enough to accommodate the vehicle. The Rear-view Camera is manually activated by pressing a button on the console, or automatically activated when the reverse gear is engaged.

Get the latest information on BMW standard and optional features, packages and technical specifications. Visit [bmwusa.com](http://bmwusa.com), select the BMW model of your choice, and click on "Features & Specs."

# STAY TOTALLY IN TOUCH WHEREVER YOU GO – WITH BMW CONNECTED DRIVE.

Whether you're far from home or just in the next town, ConnectedDrive offers convenience and peace of mind. There are new features that extend BMW's leadership in wireless communications. Marvel at an extensive array of new Mobile Office functions. Get a visual image of your callers. ConnectedDrive offers all this - and more.

[bmwusa.com/connecteddrive](http://bmwusa.com/connecteddrive)

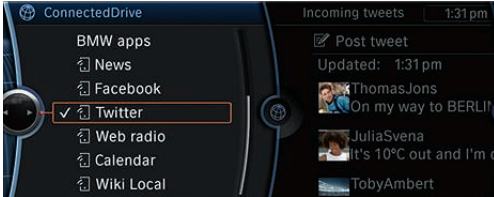

**BMW Apps** lets you access social networks through your iPhone®, and see them on the Display screen.<sup>1</sup> Tune in to **Web radio** and search for stations from around the globe by name, location or genre. You can also store your favorite stations, find similar stations, display station information, and change the quality of the audio. Your favorite entries are stored on your iPhone, so you can take them with you from one vehicle to another.

Please note: • A broadband data link is required. The costs for this (e.g., data roaming) are regulated by the customer agreement with the mobile phone service provider.  
• Not all features available while vehicle is in motion; see dealer for details.  
• Web radio audio quality depends on the bit rate of the station, and data reception depends on your cell service. Data transfer comes over the iPhone.



**BMW Connected App**, a suite of integrated web-connected features, can read aloud your Facebook® and Twitter® feeds, and lets you send prewritten tweets with a single click. **Wiki Local** finds and reads aloud Wikipedia® articles based on your location or destination while **Wiki Tourguide** finds and lists articles about nearby points of interest, sorted by distance from your vehicle's current location. The **Last Mile Navigation** and **Vehicle Finder** provide walking directions to your destination after you've parked – and directions back to your car later.

Please note: Local information may not be available in all areas.



Add the popular **Stitcher SmartRadio™** app to your smartphone and create your own personal talk radio station experience. The mobile leader in on-demand news, entertainment, sports and talk radio, Stitcher SmartRadio not only lets you create and run your favorite programs, it introduces you to new content, based on your personal preferences.

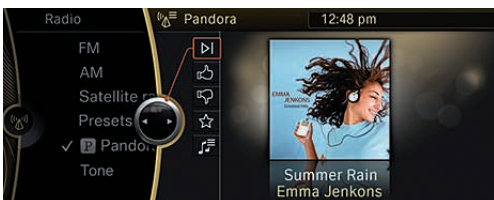

Part of BMW Apps, **Pandora®** is an innovative streaming audio service that delivers personalized music selections right to your BMW.<sup>1</sup> Create new stations and tailor your listening experience by rating songs with either a thumbs-up or thumbs-down. Even while listening, you can stay in touch: your BMW can still receive calls through Bluetooth® technology without missing a beat.

<sup>1</sup> Requires BMW Apps option and a compatible iPhone and iOS version.



**MyInfo** allows you to send business locations and street addresses to your BMW from Google Maps.™ Destinations and phone numbers can be accessed and exported to your Navigation system for immediate route guidance.

Get the latest information on BMW standard and optional features, packages and technical specifications. Visit [bmwusa.com](http://bmwusa.com), select the BMW model of your choice, and click on "Features & Specs."



Use the time you spend in your vehicle even more effectively with BMW's **Mobile Office** feature.<sup>2</sup> For example, text messages and emails can be transferred from your Bluetooth paired phone directly to the vehicle's Control Display and can be read back to you using Text-to-speech functionality and the vehicle's audio system.

<sup>2</sup> Not all mobile phones are compatible with Mobile Office, and some compatible phones support a limited number of Mobile Office functions. For the complete list of compatible mobile phones and the details regarding which Mobile Office functions are supported by each phone, please visit [bmwusa.com/bluetooth](http://bmwusa.com/bluetooth).

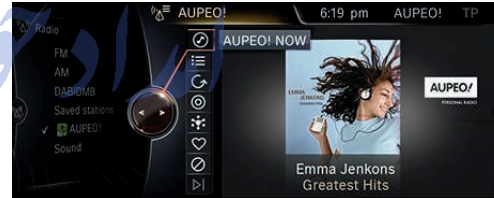

Enjoy discovering new favorite sounds in your BMW, thanks to the **AUPEO! Personal Radio** app – another part of BMW Apps. This customizable internet radio service uses a recommender system to match music to your individual taste. Enter a genre or artist, and an algorithm developed by the Fraunhofer Institute recommends tracks that match your taste, compiled from a database of almost one million tracks. You can also use the Mood Tuner function, which selects sounds according to mood; or choose from more than 150 channels pre-compiled into categories, such as 80s Best or Rock Classics.

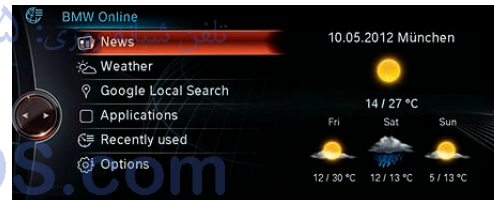

**BMW Online** allows online access to up-to-date fuel prices and gas station locations; the latest weather forecasts, advisories and warnings; Dow Jones, S&P 500 and NASDAQ indices; and the powerful reach of the Google Maps database – all delivered on the Control Display inside your vehicle. Access news headlines and have them read aloud via Text-to-speech technology. "Send to Mail" pinpoints your current location and planned destination, and allows you to send the information to any smartphone or email account. Then it's just a quick hyperlink to Google Maps for your friends and family to see where you are and where you're going.



**Enhanced functions** add to the ease and pleasure of using your iPod or iPhone. Want to know which CD that song comes from? The album cover is shown on your Display screen. Don't purchase additional cables – your iPod or iPhone's original USB cable connects to your BMW's USB port. Another rare feature: with Bluetooth Audio Streaming, you can wirelessly play music through the BMW audio system from any Bluetooth compatible music player or mobile phone, from anywhere in your vehicle.



**BMW Assist eCall™** gives you peace of mind knowing that a friendly response specialist is there to help you 24/7, at the touch of a button. It includes Automatic Collision Notification, Emergency Request (SOS button) and Customer Relations. **TeleService** transmits your vehicle's operating status and upcoming service needs to your preferred BMW center. **Concierge** adds personalized Directions and services for restaurant and hotel recommendations, with the destination address and phone number sent to your BMW. Make up to four operator-assisted calls per year with Critical Calling if your mobile phone is not available or its battery is discharged.

AN INGENUOUS  
COMBINATION.

Engineer Jan Kretschmer has headed BMW's automatic transmission department since 2008. He started at BMW back in 1994 and has been responsible for projects such as the Sequential Manual Gearbox (SMG).

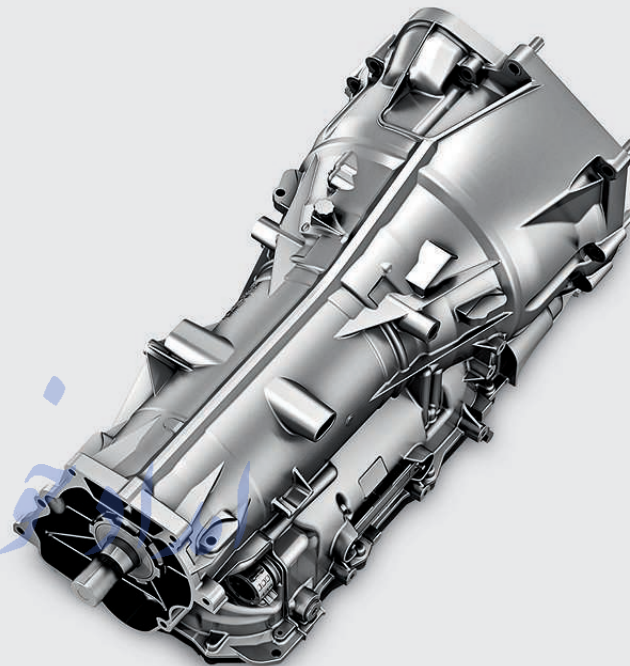
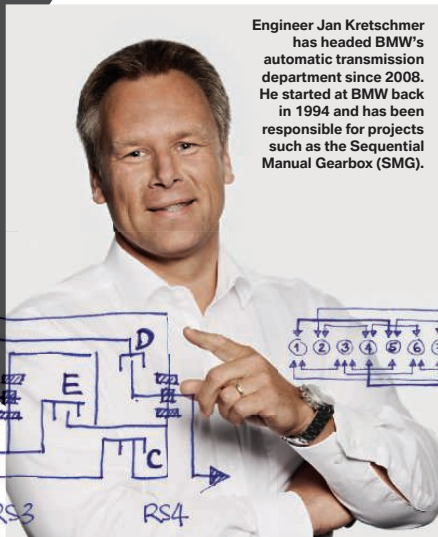

تلفن شبانه روزی: ۰۲۱-۸۸۸۶۲۰۸۵

FarmaSOS.com

**Seldom has a transmission received such high praise as the BMW 8-speed STEPTRONIC automatic transmission.**

In 2006, a group of BMW engineers scored a major breakthrough: they worked out the one optimal configuration out of ten million possible variations for an 8-speed automatic transmission. The BMW X3 benefits from their discovery. For the first time ever, the BMW X3's automatic transmission now consumes the same or even less fuel than the equivalent model with a manual transmission – regardless of the engine type – thanks to a new level of mechanical efficiency and advanced engineering.

Jan Kretschmer heads up BMW's development team for automatic transmissions and is intimately familiar with the magic combination.

"It is the only possible configuration of four gear sets and five shift elements for an 8-speed transmission with this high degree of efficiency." The 8-speed automatic is not only more efficient than other transmissions in its class; one of its main characteristics is the level of comfort it provides. Gear shifts in the BMW X3 are incredibly smooth and discreet. Just as any experienced driver with a manual transmission would do, this 8-speed automatic transmission stays in a low gear ahead of turns, so as to best accelerate out of them. And on long downhill stretches, it downshifts to make use of the engine's braking force.

These sort of capabilities result from the work put in by Jan Kretschmer and his team. Using the vehicle sensors, they analyzed every on-road set of circumstances and defined the appropriate gear. Comfortable and efficient, this 8-speed automatic transmission is also exceptionally quick. When needed it can switch gears faster than a racecar driver. It can also skip as many gears as necessary, switching directly from eighth down to second gear.

The ingenious combination that our engineering team worked out for the BMW X3 now governs gear selection in hundreds of thousands of vehicles, over countless miles of road worldwide. With its precision and efficiency, it truly brings the engine and the driver together.

## White heat.



The BMW X3 stands apart from the crowd in deep Alpine White paint, paired with 18-inch V Spoke (Style 307) light alloy wheels. Black Nevada Leather

upholstery with light contrast stitching, and Fineline Wave Wood trim give the elegant, airy cabin an unmistakable character.

## True blue.



To achieve a dynamic look, team attention-getting Deep Sea Blue Metallic paint and the gleam of 19-inch Double Spoke (Style 309) light alloy wheels on the

X3 xDrive35i. This sporty attitude continues inside with sport seats upholstered in Sand Beige Nevada Leather with Fineline Siena Wood interior trim.

تلفن شبانه روزی: ۰۸۵-۸۸۸۶۲۰۲۱

FarmaSOS.com



Get the latest information on BMW standard and optional features, packages and technical specifications. Visit [bmwusa.com](http://bmwusa.com), select the BMW model of your choice, and click on "Features & Specs."

## Muscular charisma: the M Sport Package.

Performance enhancements and sporting accents highlight the BMW X3's athleticism, inside and out.

The **M Sport Package** injects the look and feel of BMW M to an already energetic performer, with technologies like Dynamic Damping Control and Performance Control increasing the BMW X3's precise, athletic handling.

Your choice of dramatic high-gloss shadowline trim or BMW Individual Satin Aluminum trim frames the windows and covers the roof rails. The muscular look of an Aerodynamic kit is enhanced by the gleam of 19-inch Double Spoke (Style 369M) light alloy wheels with run-flat all-season tires.<sup>1</sup> And only vehicles boasting the M Sport Package can be ordered in Carbon Black Metallic.

The excitement continues inside, where M door sills and footrests welcome you into the performance-styled cabin. The thick, three-spoke M sport steering wheel offers superb grip; in the BMW X3 xDrive35i the hands-on thrill of an 8-speed Sport Automatic transmission with Sport and Manual shift modes and steering wheel-mounted paddle shifters get your adrenaline pumping. Power front sport seats with adjustable back bolsters and thigh support hold you tight when cornering, while overhead, an Anthracite headliner adds to the high-performance ambiance.



Step up to eye-catching M style with **M door-sill finishers** with chrome insets and the M logo.



**Leather-wrapped multi-function M sport steering wheel** with the M logo is purpose-driven. The wide rim is designed for better grip, while steering wheel-mounted paddle shifters let you switch gears while keeping your hands on the wheel.



**Sport seats** are 8-way power adjustable and specially bolstered to hold you snugly in place during sporty driving maneuvers, while supporting you comfortably over long drives.

امداد خودرو فارما

تلفن شبانه روزی: ۰۸۵-۸۸۸۶۲

alphaSOS.com



<sup>1</sup>Run-flat tires do not come equipped with a spare tire and wheel. Driving over rough or damaged road surfaces, as well as debris, curbs and other obstacles, can cause serious damage to wheels, tires and suspension parts. This is more likely to occur with low-profile tires, which provide less cushioning between the wheel and the road. Be careful to avoid road hazards and reduce your speed, especially if your vehicle is equipped with low-profile tires.

Wheel and tire specifications are subject to change. Get the latest information on BMW standard and optional features, packages and technical specifications. Visit [bmwusa.com](http://bmwusa.com), select the BMW model of your choice, and click on "Features & Specs."

## DREAM IT. BUILD IT. DRIVE IT.

There are many advantages to factory-ordering your BMW X3: watching its construction and getting it delivered in four to six weeks – or taking advantage of the BMW Performance Center Delivery experience, courtesy of BMW.

When you factory-order a new BMW X3, you can actually watch it being built, with video clips and stills from many of its major construction moments at the BMW Manufacturing Co. in Spartanburg, South Carolina. Since it's assembled in the U.S., your custom-ordered X3 can be delivered to your BMW center in as little as four to six weeks.

Better yet, turn this exciting occasion into a complete adventure with BMW Performance Center Delivery. After enjoying dinner and an overnight stay at a first-class hotel, you and a companion will be given an in-depth introduction to your new BMW by a Product Specialist. Then, at the BMW Performance Driving School, you'll get tips from a professional driving instructor as you explore the dynamic capabilities of a similar model. While you're there, be sure to visit the Zentrum museum, where BMW's past, present and future come together; and the gift shop, where you can find a wide selection of enticing Lifestyle Accessories. It's exciting, it's enlightening, and it's all compliments of BMW with your new vehicle.

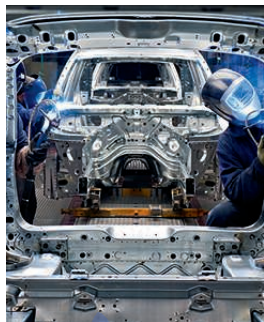

### BMW Performance Center



A sprawling, modern \$12 million complex, the BMW Performance Center houses the world-famous BMW Performance Driving School, as well as the Zentrum Museum, BMW Boutique, BMW Delivery Center, and a Corporate Conference Center.

BMW Manufacturing Co. is the sole place of origin for all BMW X3 vehicles worldwide. BMW's recent expansion of this remarkable facility features a number of advanced and environmentally conscious construction processes and technologies.

It's not just the BMW X3 that's built in Spartanburg. All BMW X5 and X6 vehicles, including the M versions, are also made in BMW's South Carolina plant.





## Exterior colors.



668 Jet Black (Non-metallic)

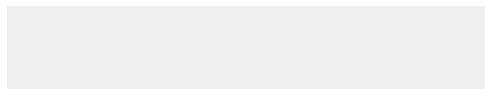

300 Alpine White (Non-metallic)



475 Black Sapphire Metallic



354 Titanium Silver Metallic



806 Sparkling Bronze Metallic



A52 Space Gray Metallic



A14 Mineral Silver Metallic



A82 Vermilion Red Metallic



A76 Deep Sea Blue Metallic



896 Blue Water Metallic



416 Carbon Black Metallic

## Upholstery colors and materials.



KCB4 Beige Leatherette



KCSW Black Leatherette



LUB4 Sand Beige Nevada Leather



LUBK Mojave Nevada Leather



LUCX Oyster Nevada Leather



LUCZ Chestnut Nevada Leather

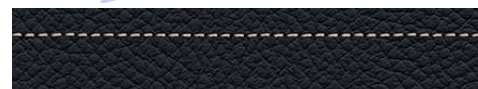

LUSW Black Nevada Leather

اردو خودرو فارما  
تلفن شبانه روزی: ۰۲۱-۸۸۸۶۲۰۸۵

FarmaSOS.com

The pages in this section of the brochure show available colors and materials for the BMW X3 SAV<sup>®</sup>. Use these samples to compare paint, upholstery, trim colors and combinations. Please note that these samples are representations; they are not exact reproductions. To see the actual colors, visit your local authorized BMW center. They will be happy to show you original samples and assist you with special requests.

Leather upholstery: Leather on all seating surfaces; other components may be Leather or Leatherette.

For details on the availability of standard and optional exterior paints and upholstery materials and colors, please visit [bmwusa.com/byo](http://bmwusa.com/byo).

## Interior trims.



4CG Silver Matte



4AD Brushed Aluminum



4CH Finesline Wave Wood



4DE Finesline Siena Wood

## Recommended color combinations.

Upholstery materials	Leatherette		Nevada Leather				
	Beige	Black	Sand Beige	Mojave	Oyster	Chestnut	Black
<b>Upholstery colors</b>							
<b>Exterior colors</b>							
668 Jet Black (Non-metallic)	●	●	●	●	●	●	●
300 Alpine White (Non-metallic)	●	●	●	●	●	●	●
475 Black Sapphire Metallic	●	●	●	●	●	●	●
354 Titanium Silver Metallic	●	●	●	●	●	●	●
B06 Sparkling Bronze Metallic	●	●	●	●	●	●	●
A52 Space Gray Metallic	●	●	●	●	●	●	●
A14 Mineral Silver Metallic	●	●	●	●	●	●	●
A82 Vermilion Red Metallic	●	●	●	●	●	●	●
A76 Deep Sea Blue Metallic	●	●	●	●	●	●	●
896 Blue Water Metallic	●	●	●	●	●	●	●
416 Carbon Black Metallic	●	●	●	●	●	●	●
<b>Interior trims</b>							
4CG Silver Matte	●	●	●	●	●	●	●
4AD Brushed Aluminum	●	●	●	●	●	●	●
4CH Finesline Wave Wood	●	●	●	●	●	●	●
4DE Finesline Siena Wood	●	●	●	●	●	●	●

● Recommended color combination

Leather upholstery: Leather on all seating surfaces; other components may be Leather or Leatherette.

For details on the availability of standard and optional exterior paints and upholstery materials and colors, please visit [bmwusa.com/byo](http://bmwusa.com/byo).

## Equipment features and options.



**Xenon Adaptive Headlights** optimize road illumination when entering a turn or corner, helping to enhance visibility when driving at night. Sensors continuously monitor the angle of the steering wheel to determine the direction in which your vehicle is heading. The outer headlights swivel accordingly, up to 15 degrees left or right. **Xenon low- and high-beam headlights** illuminate the road ahead and to the side. An auto-leveling feature adjusts for varying passenger and cargo loads. LED **Corona headlight-rings** that circle both headlights and high beams also act separately as Daytime Running Lights and parking lights.

**Automatic high beams** automatically switch between high and low beams according to oncoming traffic, traffic ahead, and the level of street lighting.



**Rain sensor** uses infrared light to measure the amount of rain. When the wipers are in the "intermittent" mode, the rain sensor automatically adjusts the windshield-wiping interval as needed. **Automatic headlight control** (not shown), included with rain sensor, activates headlights by means of a sensor that responds to darkness.



**Lights package** adds lights in the door handles that radiate downward for approximately 20 seconds when doors are unlocked, allowing safe vehicle access in the dark. Ambiance lighting, illuminated driver and front-passenger vanity mirrors, front footwell lights, front and rear reading lights, and lighting for the storage compartment in the instrument panel are also included.



BMW's distinctive **twin-kidney grille** features a chrome surround with aluminum vertical slats. It is positioned above a supplemental intake grille in the front fascia.



**Taillight cluster** with taillight, brakelights and turn-signal indicators incorporate LED technology for greater visibility.

**Adaptive Brakelights** warn following vehicles by increasing in brightness when the intensity of your braking action is increased.



**Satin Aluminum roof rails**, cleanly integrated into the BMW X3's design, provide the foundation for BMW's (accessory) modular roof rack system, which allows the convenient and secure transporting of luggage, bicycles, surfboards, etc.



**Panoramic moonroof** features extra-large dual-glass panels to let the sun and stars shine in, whether it is open or closed. Easy-to-use features include a power slide and lift control, a comfort opening/closing function, and a power sunshade to shield passengers from excessive glare and heat.



**Power tailgate** conveniently opens and closes at the touch of a button on the remote key.



**Dual circular-chrome-surround exhaust tips** are cleanly integrated into the left side of the BMW X3 rear fascia.

FarmaSOS.com

## Equipment features and options.



**V Spoke (Style 307)** 18x8.0 light alloy wheels with 245/50 run-flat all-season tires.<sup>1</sup>



**Y Spoke (Style 308)** 18x8.0 light alloy wheels with 245/50 run-flat all-season tires.<sup>1</sup>



**Double Spoke (Style 309)** 19x8.5 light alloy wheels with 245/45 run-flat all-season tires.<sup>1</sup>



**Double Spoke (Style 369M)** 19x8.5 light alloy wheels with 245/45 run-flat all-season tires.<sup>1</sup>



**Three-spoke leather-wrapped multi-function sport steering wheel** with power tilt/telescoping feature lets you keep both hands on the wheel while adjusting both the audio and a Bluetooth® enabled mobile phone. The left-hand buttons are used to operate all cruise control functions, while those on the right serve the audio functions, such as radio, phone and Voice command. **Variable Sport Steering** continuously adjusts the steering ratio and steering force to suit the changing driving situation.



**Three-spoke leather-wrapped multi-function steering wheel** provides buttons on the left for operating the cruise control functions; buttons on the right adjust all audio-related functions, including Bluetooth enabled mobile phone.



**8-speed STEPTRONIC automatic transmission** with Adaptive Transmission Control (ATC) provides extremely fast synchronized shifting in either the Sport or Manual shift mode. By increasing the number of gears to eight, the transmission provides a more efficient shifting sequence and improved fuel economy.

**8-speed Sport Automatic transmission** includes Adaptive Transmission Control (ATC) with Sport or Manual shift modes and steering wheel-mounted paddle shifters. When in Sport mode, shifts can be generated via the console-mounted shift lever or the paddle shifters.



**Instrument panel** features a red backlit speedometer and tachometer. Centered between the two easy-to-read analog instruments is the on-board computer with liquid crystal display providing additional important driving information.

<sup>1</sup> Run-flat tires do not come equipped with a spare tire and wheel. Driving over rough or damaged road surfaces, as well as debris, curbs and other obstacles, can cause serious damage to wheels, tires and suspension parts. This is more likely to occur with low-profile tires, which provide less cushioning between the wheel and the road. Be careful to avoid road hazards and reduce your speed, especially if your vehicle is equipped with low-profile tires.

<sup>2</sup> Cruise control is not a substitute for the driver's own responsibility in adjusting speed and otherwise controlling the vehicle. After evaluating the road, traffic and visibility conditions, the driver must decide whether and how the system is used.



**Dynamic Cruise Control** lets you set and keep to a chosen speed above 20 mph, including automatic application of the brakes when driving downhill. It is activated and regulated via controls positioned on the left side of the steering wheel, and deactivated by applying the brakes or switching off the feature.<sup>2</sup>



**Automatic-dimming interior and exterior mirrors** sense the bright headlights of vehicles behind you, and automatically darken. The exterior power-adjustable side-view mirrors include fold-in function. **Alarm system** emits an acoustic signal and immediately switches on the hazard warning lights in the event of an attempted break-in or tampering.



**iDrive Controller**, conveniently located on the center console, is the central command element for the iDrive system. It can be rotated, pushed and tilted to operate various functions via the Control Display. Four frequently selected menus – CD, radio, Navigation system and telephone – can be called up using direct menu-control buttons.



**BMW Apps**, a feature of the BMW ConnectedDrive interface, allows an iPhone® iOS 4.x to play apps specially modified for BMW and BMW-approved third-party apps. Imagine accessing your Twitter® or Facebook® account in the Display monitor, or listening to Web radio while you drive. Use the iPod® Out function with your smartphone to select music tracks, compile playlists and use Genius to find similar sounds. **Smartphone Integration**, which provides connectivity for iPhone and similar devices, is included with Enhanced USB and Bluetooth Audio Streaming. In conjunction with the Snap-in Adaptor accessory it allows access to stored music, can improve signal reception, and recharges the phone battery. (See your BMW center for compatible phone models.)



**BMW anti-theft AM/FM stereo CD/MP3 player** includes Radio Data System, Auto-Store, and 3-channel FM diversity antenna; reads/displays song title.



**Premium high-fidelity system** is a 16-speaker, multi-channel system that outputs reproduction of the surround information contained in the stereo signal in a nine-channel format (seven mid- and high-range channels and two central bass channels) as well as 5.1 surround sound from a DVD source. Includes a 600-watt digital amplifier with nine channels. The system compensates for driving noise in smooth steps with speed-dependent equalizing. All 16 speakers are fitted with very strong, yet compact neodymium drives.

Wheel and tire specifications are subject to change. Get the latest information on BMW standard and optional features, packages and technical specifications. Visit [bmwusa.com](http://bmwusa.com), select the BMW model of your choice, and click on "Features & Specs."



**HD Radio™** receives free, digital AM/FM broadcasts in clear, static-free sound, multicast FM stations, and innovative data services.



**Automatic climate control system** allows occupants to select a specific cabin temperature and choice of fan speeds, as well as automatic or manual airflow and recirculation. The automatic recirculation control activates whenever certain air pollutants are detected. The system also includes defrost/demist and MAX A/C functions.

## Equipment features and options.



**Eight-way power front sport seats** with two-way manual thigh support adjustment and driver's-seat memory system make the driving experience more enjoyable. Thanks to specially padded, highly contoured adjustable side bolsters, sport seats provide optimum lateral support during tight cornering, while remaining exceptionally comfortable when driving over long distances. The seats also include two-way manual adjustment for the head restraints.



**Eight-way adjustable front seats**, shown here upholstered in Mojave Nevada Leather, include two-way manual headrests and driver's-seat and mirror memory.



**Storage space** abounds throughout the BMW X3's cabin – in the front center console, in door storage pockets and in the rear cabin.



**Lumbar support for driver and front passenger seat** adds four-way adjustable comfort for the lower back. Lumbar support can be adjusted up/down and in/out.



**Heated steering wheel** makes gloves unnecessary for cold weather driving. A flick of the switch quickly warms the steering wheel rim to the perfect temperature.



**Rear-seat backrests** providing a 40/20/40 split afford even greater versatility by providing additional passenger seating and cargo-transporting options.



**Rear side sunshades** keep the sun's heat and glare away from the rear cabin while maintaining your privacy. When not in use, these manually adjustable sunshades conveniently disappear into the side doors.



**Privacy glass** in the rear cabin windows helps suppress excessive heating of the interior and also filters the sun's harmful UV rays more effectively than clear glass.



**Front armrest** with storage compartment opens up to allow access to the USB audio connection, and Smartphone Integration adapter. **Front cupholders** are integrated into the dashboard within convenient reach of the driver and front passenger. **Rear cupholders** are integrated into the rear-seat center armrest.



**Heated front seats** (shown) and **heated rear seats** are a welcome feature for driver and front passenger in cooler weather. By pressing the icon button, seat surface and backrest are heated and quickly radiate comfortable warmth in your choice of settings.



**Storage package** enhances safety and convenience by securing items of various sizes and shapes during transport. Includes luggage nets on the back of the front seats, under the center console on the passenger side, and on the left side of the cargo area; two cargo rails with four fastening points in the cargo area floor; a reversible mat; multi-purpose hooks; and a tensioning strap.



**Comfort Access system** offers an even greater degree of convenience: keyless access to your vehicle. Simply carrying the remote key in a pocket allows you to lock or unlock the doors by touching the door handle. The opening and closing of the power tailgate is an added function, making access to the cargo area available at the touch of a button.

FarmaSOS.com

## X-Line exterior trim.



**X-Line exterior trim package** gives a customized appearance. Using durable aluminum with a satin finish and stainless steel, each design element contributes to a cohesive sport-inspired theme that complements specific BMW X3 design features.

**Aluminum side-window trim.** Satin aluminum edging outlining the side-window frames (left and below) contributes to the eye-catching profile of the BMW X3.



**Side skirts.** The satin aluminum accent strip incorporated into each side panel (above and right) adds a subtle yet distinctive visual touch – as do the BMW door-sill finishers that greet those entering or exiting.



**Front fascia insert.** The lower part of the front fascia is trimmed with an eye-catching titanium panel.



**Inset on rear bumper.** The lower part of the rear bumper is highlighted with a titanium panel similar to the front fascia panel.



**Stainless steel luggage compartment loading sill.** The edge of the luggage compartment floor is clad in stainless steel, providing extra durability as well as an attractive look to the rear cabin.



**Door-sill finisher.** Trim with BMW logo for a gleaming welcome every time you open the door.

## Original BMW Accessories.



**X-Line Pro design package, surfboard carrier, 20-inch Star Spoke (Style 311) light alloy cast wheels in chrome.**



**BMW Holder for Apple® iPad®** mounts behind the front seats, securing and keeping the iPad handy for back-seat users. It can also be rotated 360° – great for watching films, composing email, viewing photos and more.



**Snap-in Adapter with USB interface** makes it easy to hook up your phone to make calls or listen to music.



**Floor tray, floor mat and storage box** help keep the cargo area of your BMW X3 clean and protected. The heavy-duty rubber floor tray and mat are specially tailored to fit the cargo area to contain fluids and mud. Both feature a nonslip surface. Also available: a cargo area storage box designed to safely keep smaller items from rolling around.

Driving a BMW is always a special experience – but it can be enhanced even further with Original BMW Accessories. These innovative products combine unique ideas, stunning design and easy functionality. Discover the wide range of Original BMW Accessories available to you, including accessories for the exterior, interior, technology, transporters, protection and details to customize your vehicle. For additional information on Original BMW Accessories, please visit your authorized BMW center or log on to [shopbmwusa.com](http://shopbmwusa.com).

## CRAFT YOUR OWN BMW – AT [BMWUSA.COM/BYO](http://BMWUSA.COM/BYO).

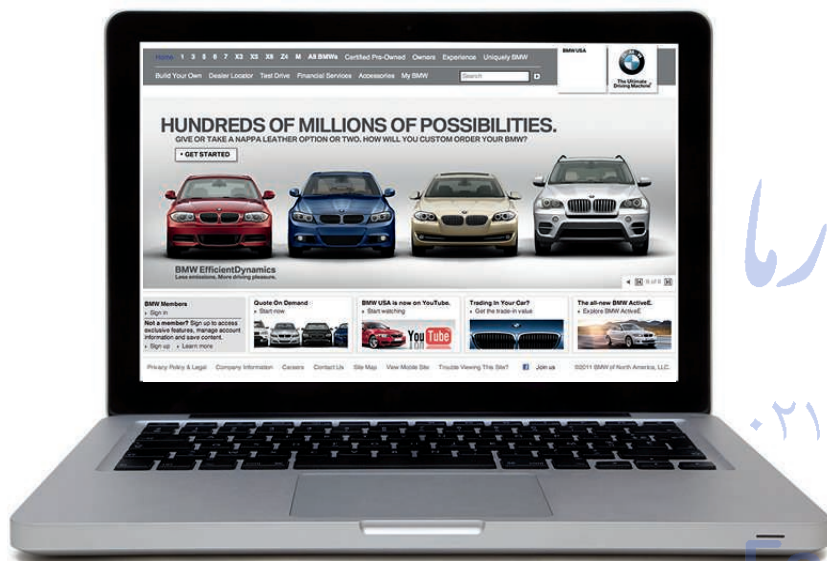

At BMW, we want you to create your own Ultimate Driving Machine® That's why BMW offers one of the widest model ranges of any luxury automotive manufacturer. And each BMW model offers its own universe of personalizing possibilities.

It's easy to get the latest information on your favorite BMW model. Simply visit [bmwusa.com](http://bmwusa.com) and click on the BMW model of your choice. Select "Features & Specs" to see all the standard features and available options and packages, as well as technical specifications.

Then create the exact BMW model that fulfills your needs by clicking on "Build Your Own" – or just visit [bmwusa.com/byo](http://bmwusa.com/byo). Here you'll be able to select from among the many interior and exterior colors and trims, personalizing options and value-added packages. Build a BMW model that reflects your style, then view it in 360° detail. At the press of a button, see payment and financing options, get a same-day quote, download a product brochure and even schedule a test drive. BMW makes it easier than ever to make your ultimate driving dreams come true, at [bmwusa.com](http://bmwusa.com).

ارزاد خودرو فارما

تلفن: ۰۲۱-۸۸۸۶۲۰۸۵

FarmaSOS.com

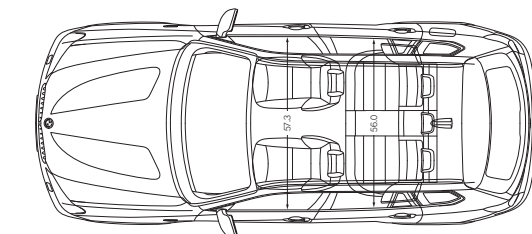
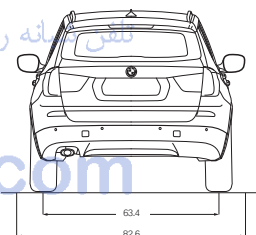
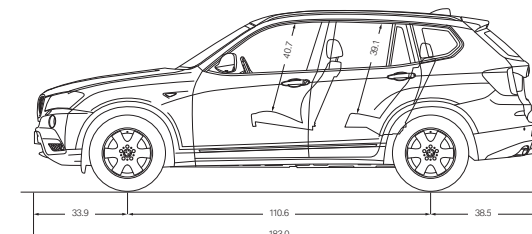
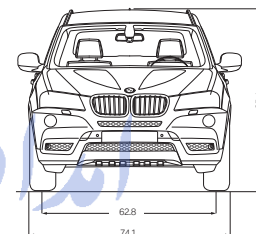

All dimensions in the technical drawings are given in inches.

Technical data		X3 xDrive28i	X3 xDrive35i
----------------	--	--------------	--------------

Weight			
Unladen weight	lb	4068	4222
Weight distribution, front / rear	%	49.9 / 50.1	49.6 / 50.4
Permitted payload	lb	904	904
Permitted roof load	lb	220	220

Engine			
Type / cylinders / valves per cylinder		TwinPower Turbo Inline 4 / 4	TwinPower Turbo Inline 6 / 4
Displacement	cc	1997	2979
Bore / stroke	inch	3.3 / 3.5	3.3 / 3.5
Nominal output / rpm	hp	240 / 5000	300 / 5800
Maximum torque / rpm	lb-ft	260 / 1250-4800	300 / 1300-5000
Compression ratio	:1	10.0	10.2

Transmission			
Automatic gear ratios – 8-speed STEPTRONIC			
I / III / III / IV	:1	4.71 / 3.14 / 2.11 / 1.67	4.71 / 3.14 / 2.11 / 1.67
V / VI / VII / VIII / R	:1	1.29 / 1.00 / 0.84 / 0.67 / 3.30	1.29 / 1.00 / 0.84 / 0.67 / 3.30
Final drive ratio	:1	3.39	3.39

Performance			
Top speed <sup>1</sup>	mph	130	130
Acceleration 0 – 60 mph <sup>2</sup>	sec	6.6	5.5

<sup>1</sup> Top speed limited electronically.

<sup>2</sup> BMW AG test results. Actual acceleration results may vary, depending on specification of vehicle; road and environmental conditions; testing procedures and driving style. These results should be used for comparison only and verification should not be attempted on public roads. BMW urges you to obey all posted speed laws and always wear safety belts.

<sup>3</sup> EPA-estimated figures are for comparison purposes only. Your actual mileage will vary, depending on speed, driving habits, trip length and driving conditions; actual mileage may be lower.

<sup>4</sup> Run-flat tires do not come equipped with a spare tire and wheel.

Technical data		X3 xDrive28i	X3 xDrive35i
----------------	--	--------------	--------------

Fuel consumption <sup>3</sup>			
City	mpg	21	19
Highway	mpg	28	26
Tank capacity, approximate	gal	17.7	17.7

Wheels			
Run-flat tire <sup>4</sup> dimensions		245 / 50	245 / 50
Wheel dimensions	inch	18 x 8.0	18 x 8.0
Material		light alloy	light alloy

Ventilated disc brakes			
Front / diameter	inch	12.9	12.9
Rear / diameter	inch	13.0	13.0

Electrical system			
Battery capacity	Ah	90	90
Alternator output	A	210	210
	W	2940	2940

U.S. Distributor: BMW of North America, LLC, Woodcliff Lake, NJ 07677. All illustrations and specifications contained in this brochure are based on the latest product information available at the time of printing. BMW reserves the right to make changes at any time, without notice, in colors, materials, equipment, specifications and models. BMW may subject to legal requirements, determine the Model Year designation of its vehicles. The Model Year designation on any particular model may be longer or shorter than 12 months. Some vehicles pictured may contain non-U.S. equipment. Some models may be shown with optional equipment. While BMW NA makes all reasonable efforts to provide accurate information in this brochure, there is no guarantee or warranty of accuracy. Furthermore, we do not assume any liability for the accuracy or completeness of information presented. This brochure shall not be used or relied upon as a substitute for information that is available from your authorized BMW center. Further information can be obtained from your authorized BMW center or [bmwusa.com](http://bmwusa.com).

©2013 BMW of North America, LLC. Not to be reproduced wholly or in part without written permission of BMW NA. The BMW name, model names and logo are registered trademarks. The Bluetooth word mark and logos are owned by the Bluetooth SIG, Inc. and any use of such marks by BMW is under license. iPhone and iPod are registered trademarks of Apple Inc. Other trademarks and trade names are the property of their respective owners.



We believe that a premium ownership experience should feature performance and luxury, as well as safety and convenience. We believe you should be able to drive a BMW to its potential, while enjoying peace of mind and reduced cost of ownership. That's the idea behind **BMW Ultimate Service**<sup>®</sup>: a suite of comprehensive programs and services that are included in every new BMW vehicle. It starts with the **New Vehicle/SAV Limited Warranty**,<sup>1</sup> providing you

with coverage for the first four years or 50,000 miles, whichever comes first. Additionally, you enjoy 12-year, unlimited-mileage warranty protection against corrosion and rust perforation.<sup>1</sup> BMW Ultimate Service continues with **BMW Maintenance Program** for up to the first four years or 50,000 miles,<sup>2</sup> **BMW Roadside Assistance**, and more.

## GOING BEYOND ENGINEERING: THE HIGH-PERFORMANCE BMW OWNERSHIP EXPERIENCE.



### BMW Maintenance Program

is one of the most comprehensive maintenance programs in its class. We cover all factory-recommended maintenance for up to the first four years or 50,000 miles, whichever comes first. This includes scheduled oil services and inspections. Also covered is the replacement of items that are subject to normal wear and tear, such as brake pads, wiper blade inserts and engine drive belts.<sup>2</sup> And, thanks to BMW's advanced engineering, most owners enjoy a well-balanced maintenance schedule, with flexible routine service intervals that can save you time. When your vehicle requires attention, your authorized BMW center ensures that it receives only genuine BMW parts – your assurance of exacting quality standards.

For more details on BMW Ultimate Service and the BMW Maintenance Program, visit your authorized BMW center or log on to [bmwusa.com/ultimateservice](http://bmwusa.com/ultimateservice).



### BMW Assist eCall,<sup>3</sup> a safety feature

of BMW ConnectedDrive, lets you enjoy peace of mind knowing that a friendly response specialist is there to help you, 24/7, at just the push of a button. This includes Emergency Request (SOS button), Automatic Collision Notification, and Customer Relations. **BMW TeleService**<sup>3</sup> continually monitors specific vehicle parts that are subject to wear and tear, as well as services that require attention at regular intervals, such as vehicle service inspections. This data is automatically transmitted to your authorized BMW center, which informs a BMW Service Advisor to call and schedule a convenient service appointment. You don't have to keep track of when your vehicle requires routine maintenance. An added benefit: any needed maintenance service parts will already be on hand, so your BMW is serviced and returned to you as quickly as possible. And because they use only Original BMW Parts, you can rely on expert fit and long-lasting BMW quality.



**BMW Roadside Assistance** is provided free of charge for the first four years – with no mileage limit. Call **1-800-332-4BMW (4269)** for friendly on-the-road help, 24/7, anywhere in the United States, Canada and Puerto Rico. This includes everything from flat-tire changes, emergency gasoline and lock-out service, to towing, alternative transportation and even trip-interruption benefits. This service also provides valuable trip-routing advice.

**BMW Online**<sup>4</sup> provides up-to-date web information: business and stock reports, as well as weather updates. BMW Online also includes **MyInfo**, which allows you to send business locations and street addresses with their associated phone numbers from the Google Maps™ website directly to your BMW. The destination can be sent to your Navigation system for turn-by-turn directions.

**Enhanced USB and Bluetooth**<sup>®</sup> with Smartphone Integration offers an array of Mobile Office<sup>5</sup> functions. With the BMW Navigation system and your mobile phone linked via Bluetooth technology, Mobile

Office transfers text messages and emails to your iDrive Display screen and then reads them aloud to you. While en route, a calendar and to-do list can also appear on your Display screen. Running late? Click on the phone number in the calendar to call your appointment. For a list of tested mobile phones, visit [bmwusa.com/bluetooth](http://bmwusa.com/bluetooth).

**Remote Services**<sup>3</sup> include Remote Door Unlock, Stolen Vehicle Recovery, and access to the My BMW Remote app, which allows you to control your BMW from your mobile device.

For the ultimate in coverage, add the optional **Concierge Services**.<sup>6</sup> You'll enjoy unlimited access to personalized Directions and services for restaurant and hotel recommendations, with the destination address and phone number not only sent right to your BMW, but also transferred to your Navigation system for route guidance. Another useful Concierge feature: **Critical Calling**. This lets you make up to four operator-assisted calls per year, up to five minutes per call, if your mobile phone is not available, or if its battery is discharged.



**BMW Financial Services.** Arranging to buy or lease a BMW is easier than you may think. Your authorized BMW center offers leasing and financing to suit your personal needs through BMW Financial Services.<sup>7</sup> Start the process at our website, where you can build your "dream vehicle," get an estimate on a monthly lease or financing payment, submit a credit application to BMW Financial Services – and get approval – all online!<sup>7</sup> To find out how BMW Financial Services can help put you behind the wheel of your favorite BMW or call, log on to [bmwusa.com/fs](http://bmwusa.com/fs) or call, toll-free, **1-800-578-5000**.



**BMW Virtual Center.** If you get the sudden urge to shop for a BMW but your authorized BMW center is closed, there's good news – the BMW Virtual Center is open 24 hours a day! Log on to [bmwusa.com/byo](http://bmwusa.com/byo), and choose the model that interests you. Configure the BMW of your dreams, and see what the monthly payments would be. You can even send the specifications to your authorized BMW center, apply for financing, or request a test drive – all online!



**BMW Magazine.** A fascinating view of the latest events and products in the world of BMW, including travel reviews, personality profiles, and the latest BMW technologies. Sent to new owners and lessees twice a year, you can also read articles from **BMW Magazine** on the BMW website at [bmwusa.com](http://bmwusa.com) under the "Explore BMW" heading, found in the "News" section under "Magazines."



**BMW Performance Driving School.** Take your driving skills to the next level. Behind the wheel of new BMWs and under the guidance of professional instructors, you'll hone your driving skills on a 1.7-mile driving course that can be configured in a multitude of ways. In One- and Two-Day Schools you can tackle the skid pad, slalom course and water walls. The BMW Performance Driving School is about control and pushing a BMW to its limits – and yours. Visit [bmwusa.com/pds](http://bmwusa.com/pds).

**Performance Center Delivery.** You'll always remember the fun of taking delivery of your new BMW – especially with BMW Performance Center Delivery in Spartanburg, SC. After enjoying dinner and an overnight stay at a first-class hotel, we'll take you and your companion to the Performance Center where a Product Specialist will give you an in-depth introduction to your new BMW. Then at the Performance Driving School, you'll get tips from a professional driving instructor as you explore the dynamic capabilities of a similar model. It's exciting, it's enlightening – and it's all compliments of BMW with your new vehicle. To learn more about the BMW Performance Center, call **1-888-345-4269** or visit [bmwusa.com/pdsdelivery](http://bmwusa.com/pdsdelivery).



The **BMW Welt** ("BMW World") delivery and brand-experience center in Munich is bold proof of BMW's passion for design. When you take advantage of the BMW European Delivery Program,<sup>8</sup> this is where you will meet your new BMW – in a personalized process that is highly dramatic and totally unforgettable. (You might also realize substantial savings that just may pay for your trip.) While you're there, marvel at the historic BMWs in the Museum; learn about our engineers' newest innovations in the Technology and Design Atelier; and take a tour of the plant to experience firsthand the state-of-the-art methods used to create a BMW. Then comes the unique experience of driving your new BMW on the roads it was designed for. To learn more, visit [bmwusa.com/europeandelivery](http://bmwusa.com/europeandelivery).

## ON-BOARD SERVICE ALERTS.

### We monitor your BMW's needs – so you don't have to.

Tackling mountain switchbacks, the last thing you should be thinking about is the state of your brake pads. Thanks to BMW's integrated on-board diagnostics system, you will always know exactly when the next service is due, and what work will be required. Condition-Based Service (CBS) measures the condition of key parts that are subject to wear and tear. It also tracks fluid levels and monitors your BMW's time- and mileage-dependent service requirements. Using this data, the Info Display in the cockpit automatically alerts you in advance whenever any part of your vehicle will require servicing – so there are no surprises ahead.

<sup>1</sup> See your authorized BMW center for details on these limited warranties.

<sup>2</sup> All BMWs come with the BMW Maintenance Program standard for up to 4 years or 50,000 miles from the in-service date, whichever comes first. The BMW Maintenance Program covers factory-recommended maintenance services as determined by the Service Interval Indicator for all new eligible MY2004 and later BMW vehicles. Exclusions from coverage include: gasoline, gasoline additives, windshield washer fluid and additives, battery, tires, wheels, wheel alignment and tire balancing. All work must be performed by an authorized BMW center. For all Model Year 2015 and later vehicles sold or leased by an authorized BMW center on or after July 1, 2014; BMW Maintenance Program coverage is not transferable to subsequent purchasers, owners or lessees. Certain limitations and exclusions apply to this program; please see [bmwusa.com/ultimateservice](http://bmwusa.com/ultimateservice) or ask your authorized BMW center for details.

<sup>3</sup> On 2014 and later BMW X3 SAV<sup>®</sup> models, BMW Assist eCall and BMW TeleService are standard and include 10 years of service. Remote Services (offered in combination with the Navigation system and included in the Technology Package) includes 10 years of service. In order to receive these services, a subscriber agreement must be completed and transferred to the BMW Assist™ Response Center. GPS and underlying wireless services must be available and functioning, vehicle ignition must be turned on (except for Remote Services), battery must be charged and connected, and vehicle's electrical system operational. Due to wireless carrier coverage, services may be limited in certain geographic areas. Call toll-free **1-888-333-6118**, go to [bmwassist.com](http://bmwassist.com), or visit your authorized BMW center for additional program details. Services are subject to the terms and conditions of your subscriber agreement.

<sup>4</sup> BMW Online comes with a 3-year subscription and is included in Technology Package or with Navigation system. Subject to the terms and conditions of your subscriber agreement. Please go to [bmwusa.com/connecteddrive](http://bmwusa.com/connecteddrive) for additional details on BMW Online.

<sup>5</sup> Not all mobile phones are compatible with Mobile Office, and some compatible phones support a limited number of Mobile Office functions. For the complete list of compatible mobile phones and the details regarding which Mobile Office functions are supported by each phone, please visit [bmwusa.com/bluetooth](http://bmwusa.com/bluetooth).

<sup>6</sup> Concierge Services (optional and requires Technology Package) includes a 3-year subscription. Subject to the terms and conditions of your subscriber agreement. Please visit [bmwusa.com/connecteddrive](http://bmwusa.com/connecteddrive) for additional details on Concierge Services.

<sup>7</sup> Subject to credit approval and other terms and conditions.

<sup>8</sup> Not all models are available for BMW European Delivery Program. Please go to [bmwusa.com/europeandelivery](http://bmwusa.com/europeandelivery) or visit your authorized BMW center for details.

More about BMW



The Ultimate Driving Machine®

bmwusa.com  
1-800-334-4BMW



امداد خودرو فارما

تلفن شبانه روزی: ۰۲۱-۸۸۸۶۴۰۸۵

FarmaSOS.com

#### BMW and the environment.

BMW is a strong proponent of the environment and social responsibility. We launched BMW EfficientDynamics back in 2000 – the philosophy of providing greater power with increased efficiency and fewer emissions. This has resulted in significant benefits today – for our customers, the climate and the environment.

That year, ecological sustainability was also declared one of BMW's core strategic principles; it is now firmly anchored in our entire production chain. It starts with the development of fuel-saving and alternative vehicle concepts, continues with environmentally friendly production processes, and ends with innovative recycling methods. This effort has been recognized worldwide; in 1999, BMW AG – the parent company of BMW of North America and BMW Manufacturing Co. in Spartanburg, SC – was the first automotive company to be represented on the Dow Jones Sustainability Group Index. It has remained on the Index ever since; moreover, since 2005, BMW has been voted the world's most sustainable automobile manufacturer. At BMW, we strive for and achieve high performance in all we do.

©2013 BMW of North America, LLC. Not to be reproduced wholly or in part without written permission of BMW NA. The BMW name, logo, model names, Sports Activity Vehicle and SAV are registered trademarks. The Bluetooth word mark and logos are owned by the Bluetooth SIG, Inc. and any use of such marks by BMW is under license. iPod, iPhone and iPad are registered trademarks of Apple Inc. Other trademarks and trade names are the property of their respective owners.

BMW recommends **EDGE**

