

2010 BMW X6  
Sports Activity  
Coupe™

X6 xDrive35i  
X6 xDrive50i  
ActiveHybrid X6



The Ultimate  
Driving Machine®



تلفن شبانه روزی: ۰۲۱-۸۸۸۶۲۰۸۵

FarmaSOS.com

**THE BMW X6.**  
A COUPE ABOVE.



امداد خودرو فارما

تلفن شبانه روزی: ۰۸۵-۸۸۸۶۲۰۲۱

FarmaSOS.com

**Contents**

**2010 BMW X6 Sports Activity Coupe™**

- 4 | 13 Exterior
- 14 | 17 Interior



**Technology**

- 18 | 19 BMW EfficientDynamics
- 20 | 21 Engines
- 22 | 25 BMW ActiveHybrid X6
- 26 | 27 Dynamic Performance Control | Active Steering | Adaptive Drive
- 28 | 29 Safety features | Head-up Display
- 30 | 31 BMW ConnectedDrive

**Equipment**

- 32 | 35 Paints | Upholsteries | Interior trims | Combinations
- 36 | 37 Selection examples
- 38 | 39 Interior luggage compartment
- 40 | 46 Standard | Optional equipment
- 47 | 53 Optional packages
- 54 | 55 Standard safety features and technology illustrations
- 56 | 62 Equipment charts
- 63 | 64 Technical data
- 65 BMW Accessories
- 66 | 67 BMW Services

The allure of a sleek, muscular coupe. The dynamic traction of an SAV.® The lightning-quick cornering of Dynamic Performance Control. The BMW X6 is the world's first four-door Sports Activity Coupe™ — a new concept where Advanced Turbo power, sophisticated luxury, and flexible storage and seating all support your driving ambitions.

	<p>X6 xDrive50i shown with the following equipment:</p>
<p><b>BMW X6</b></p> 	<p>Engine: 32-valve, Advanced Turbo 4.4-liter V-8          Exterior color: Vermilion Red Metallic          Upholstery: Oyster Nevada Leather          Interior trim: Dark Bamboo Wood          Optional equipment: Sport Package, Star Spoke (Style 259) 20" light alloy wheels, Cold Weather Package</p>
<p>For details on paint, upholstery and interior trims, please refer to pages 32-35.</p>	



امداد خودرو پارسی

تلفن: ۰۲۱-۸۸۸۶۲۰۸۵

FarmaSOS.com

The allure of thoughtful design.

BMW's engineers and designers have created an exciting and practical class of all-wheel-drive vehicles: a Sports Activity Coupe.™ Equal parts sensual and sensible, its sure-footed athleticism and striking appearance are matched by the practicality of four doors and a usable cargo area. It's a vehicle that makes no compromises in performance – on the road or in your daily life.

Breaking new ground. Setting new standards.

امداد خودرو فارما

تلفن شبانه روزی: ۰۲۶-۸۸۸۶۲۰۸۵

FarmaSOS.com



Ignite your driving passion at every turn.

The X6's innovative, sporty look reflects the components that give it a sports car-like driving feel that's not usually associated with AWD vehicles. In addition to a powerful engine and taut suspension, BMW's revolutionary Dynamic Performance Control technology can transfer power between the rear wheels for quick high-performance cornering. Adaptive Drive, which is included in the optional Sport Package, adds Active Roll Stabilization (ARS) and Electronic Damping Control (EDC) to the mix. ARS helps eliminate body roll, keeping the vehicle level, stable and agile; EDC continuously adjusts the shock absorbers from the softest to the firmest settings for outstanding compliance and body control. In the X6, it all comes together in a unique driving experience.



امداد خودرو فارس

تلفن شبانه روزی: ۰۲۱-۸۸۸۶۲۰۸۵

FarmaSOS.com

Adaptable grip and smart brakes to conquer any road, in any weather.

Not all roads are dry and level, freshly paved straightaways. That's good news for the X6 Sports Activity Coupe.™ It welcomes challenges, easily tackling rough surfaces, tight corners, steep climbs and steeper downhills. Power distribution is nominally 40% front axle, 60% rear, for balanced handling. However, BMW's xDrive intelligent all-wheel-drive technology continuously and undetectably transfers power between both axles, depending upon which has greater traction, while Dynamic Performance Control transfers power between the two rear wheels. On gentle downgrades, Dynamic Cruise Control<sup>1</sup> applies the brakes automatically, keeping you at a constant speed. And on a steep downhill grade, press the Hill Descent Control button to help keep the X6 to a steady crawl without even touching the brakes. Speaking of brakes, Dynamic Stability Control includes four innovative brake-optimizing features. When stopped on a hill, **Start-off Assistant** helps keep the X6 from rolling forward or backward after you take your foot off the brake pedal. When you quickly take your foot off the accelerator, **Brake Stand-by** anticipates the need for a short stop, and pre-tenses the calipers. Whenever moisture is detected, **Brake Drying** periodically and discreetly brings the brake pads into contact with the rotors to help dry them. And on long, gradual downhill slopes, **Brake Fade Compensation** helps keep your brake pedal action even, so you don't have to keep increasing brake pressure.

<sup>1</sup> Dynamic Cruise Control is not a substitute for the driver's own responsibility in adjusting speed and otherwise controlling the vehicle. After evaluating road, traffic and visibility conditions, the driver must decide whether and how the system is used.

امداد خودرو فارما

تلفن: ۰۲۱-۸۸۸۶۲۰۸۵

FarmaSO3.com



Drive all you want — you can't throw it off guard.

In addition to inventing its own class, the BMW X6 brings with it a host of innovative technologies. Chief among them: the outstanding driving characteristics of Dynamic Performance Control. Based on BMW's intelligent xDrive all-wheel-drive system that seamlessly distributes power from rear to front, Dynamic Performance Control adds a secondary functionality of shifting power between the rear wheels. This helps maintain the sportier driving dynamics associated with rear-wheel-drive vehicles, so you get the best of both worlds: sporty road feel combined with pavement-hugging traction. It's an idea that perfectly fits the X6.

امداد خودرو فارما

تلفن شبانه روزی: ۰۲۱-۸۸۸۶۲۰۸۵

FarmaSOS.com





امداد خودرو فارس

تلفن شبانه روزی: ۰۸۵-۸۸۸۶۴-۰۲۱

FarmasOS.com

Inside a unique vehicle, a familiar perspective.

The X6 may be difficult to classify at first glance. But from behind the wheel, it looks exactly like a BMW. The leather-wrapped multi-function sport steering wheel swiftly transmits your every driving input. Steering wheel-mounted paddle shifters make shifting through all six gears a motorsport-inspired experience. Every gauge and instrument dial is easy to read; every control is conveniently placed within arm's length. Standard appointments include the newest version of iDrive, which offers a variety of entertainment and communications options, six programmable memory buttons, and a hard drive with 12 GB of space that can store up to 2,000 songs. A unique touch: kneepads that give your legs a better grip in tight turns. And the commanding seat position reminds you that once you're in the X6, you're in charge of the road.



### 360 degrees of pure BMW luxury.

You have to hand it to the BMW designers: they truly understand the concept of comfort. The X6 offers a spacious interior, with a surprising amount of leg- and headroom for both the front and back seats. And while some all-wheel-drive vehicles may favor utility over luxury, the X6 impresses with a wealth of premium interior features, such as supple Nevada Leather upholstery and exotic Dark Bamboo Wood trim. So no matter what the scenery outside offers, the view of the cabin is always first-rate.



امداد خودرو فارما

تلفن شبانه روزی: ۰۲۱-۸۸۸۶۲۰۸۵

FarmaSOS.com

This is how much has gone in.

At BMW, we create dynamic vehicles that thrill you with quick acceleration, predictable handling and unshakable control. We are also busy finding ways to sustain this level of performance while incorporating innovative fuels and technologies to help preserve the environment. This is what we refer to as EfficientDynamics. This goal has led to the visionary CleanEnergy hydrogen-powered engine, which is currently used in the emission-free BMW Hydrogen 7 Sedan. BMW Advanced Diesel with BluePerformance, which offers diesel power with quick acceleration, increased fuel efficiency and reduced emissions, was introduced to the U.S. in select models in 2009. In fact, every BMW on the road today comes standard with technology that boosts performance while simultaneously reducing fuel consumption and CO<sub>2</sub> emissions.

**High Precision Injection**

Turbocharging is traditionally known for boosting power at the expense of fuel efficiency. BMW Advanced Turbo engines with piezo direct fuel injection, however, inject gasoline at high pressure and with extreme precision into each cylinder. And, thanks to BMW's fast and flexible electronic control system, both the timing and quantity of the fuel injections can be precisely adjusted to driving conditions. As a result, BMW vehicles achieve greater power with excellent fuel efficiency.

**Aerodynamics**

The more smoothly that air flows over a vehicle, the more efficiently it can operate. All BMWs are designed for a low coefficient of aerodynamic drag, which translates into quicker acceleration, more stable handling, quieter operation and greater fuel efficiency. A BMW's integrated front spoilers reduce the amount of air flowing underneath, minimizing front-end lift. This allows a BMW to hug the road at higher speeds for excellent stability.

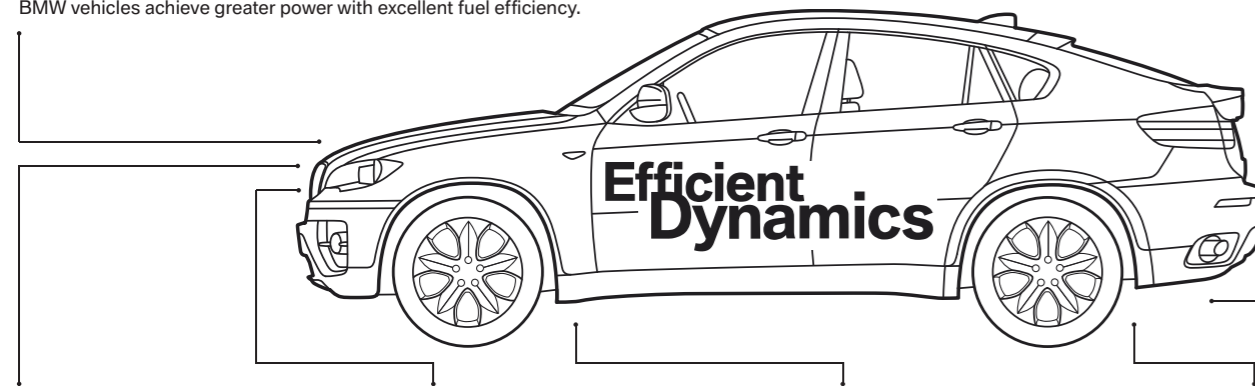

**Double-VANOS**

VANOS is BMW's valve timing system that can steplessly vary the points in the combustion cycle when valves open and close. Double-VANOS refers to the fact that it operates on both the intake and exhaust camshafts. Electronically controlled in response to engine speed, load and temperature, VANOS reduces emissions, and enhances low- to medium-speed torque, as well as fuel efficiency.

**Advanced Turbo engines**

Benefiting from BMW's Advanced Turbo technology, both X6 engines deliver quick acceleration while virtually eliminating turbo lag. Fuel economy is strong, as well, thanks to precise piezo direct fuel injection.

**Efficient automatic transmission**

A highly efficient 6-speed Sport Automatic transmission with Adaptive Transmission Control, Sport and STEPTRONIC Manual shift modes, and steering wheel-mounted paddle shifters enhances performance, comfort and fuel efficiency.

**Lightweight construction**

Our engineers use lightweight aluminum throughout our vehicles in the front section, for example, or for the suspension. BMW's inline six-cylinder Advanced Turbo engine is all aluminum. Taken together, these weight savings lead to lower fuel consumption and better axle load distribution for more agility especially in curves.

And this is what comes out.

امداد خودرو فارما

تلفن شبانه روزی: ۰۲۱-۸۸۸۶۲۰۸۵

FarmaSOS.com

BMW models have low CO<sub>2</sub> emissions today. But that's just for starters. We're carrying on our research in the quest to bring you greater driving pleasure, with fewer emissions and decreased fuel consumption.



The Advanced Turbo V-8 engine in the X6 xDrive50i delivers eager acceleration in every driving situation. It's also efficient, thanks to its direct fuel-injection system.

A turbocharged driving experience is par for the course.

Dynamic ultimate driving requires an engine that can keep up. Both engine options for the X6 offer plenty of muscle to go from smooth highway driving to exhilarating uphill charges, all with BMW's signature crisp acceleration and responsive powerband. You'll find the X6 is capable of handling even the most challenging drives with ease.

In both engines, "turbo lag" is virtually a thing of the past, thanks to BMW's innovative use of Advanced Turbo technology, direct injection, VANOS and clean engine management software. These features also help make BMW turbocharged engines remarkably fuel-efficient.



**BMW EfficientDynamics**  
Less emissions. More driving pleasure.

Two engines. Six gears. One great vehicle. The X6.

However you prefer your acceleration, there is an X6 that's precisely your speed.

**X6 xDrive35i:** This revolutionary inline six-cylinder Advanced Turbo powerplant, named "International Engine of the Year" in 2007, 2008 and 2009, offers an outstanding 300 hp and 300 lb-ft of torque, launching the X6 xDrive35i from 0-60 in 6.5 exhilarating seconds.<sup>1</sup> It not only delivers thrilling driving, but is also one of the most fuel-efficient six-cylinder engines on the market.

**X6 xDrive50i:** BMW engineers developed a V-8 for the X6 xDrive50i that features cutting-edge Advanced Turbo power for reliable, virtually lag-free performance and acceleration in any situation. Both brawny and efficient, this 400-hp engine generates 450 lb-ft of torque to propel the X6 xDrive50i from 0-60 in a scant 5.3 seconds.<sup>1</sup>

The X6 channels power through a smooth-shifting, 6-speed Sport Automatic transmission. Use the sleek, ergonomically designed electronic shift knob to select Automatic with Adaptive Transmission Control, Sport, or STEPTRONIC Manual shift modes. And when the urge for racing-inspired driving excitement strikes, steering wheel-mounted paddle shifters offer quick control.

<sup>1</sup> BMW AG test results. BMW urges you to obey all posted speed laws and always wear safety belts.

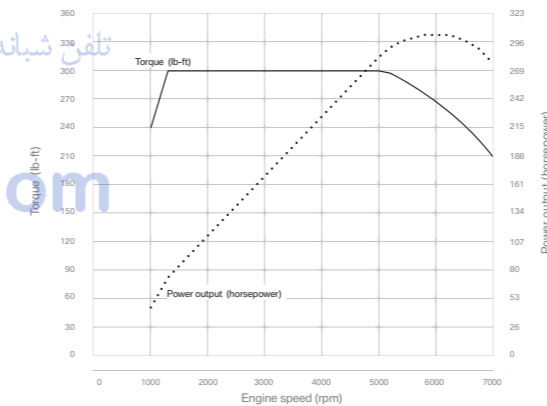

**Portrait of an engineering masterpiece: the X6 xDrive35i Advanced Turbo engine produces 300 hp at 5800 rpm, and quickly develops 300 lb-ft of torque at 1400 rpm, which continues without fading through to the 5000 rpm range. With such a broad range of powerful torque, you can enjoy smooth, robust acceleration in any gear, at any speed.**



**BMW's 300-hp, Advanced Turbo inline six, which powers the X6 xDrive35i, was named "International Engine of the Year" for three years running in 2007, 2008 and 2009.<sup>2</sup>**

<sup>2</sup>International Engine of the Year awards.



امداد خودرو فارما

تلفن شبانه روزی: ۰۸۵-۸۸۸۶۲۰۲۱

FarmaSOS.com

A new form of hybrid power that's nothing short of electrifying.

Forget everything you previously thought about hybrids: that they are slow, unexciting vehicles that sacrifice fun in the name of frugality. Just as the X6 is the world's first Sports Activity Coupe,<sup>TM</sup> BMW is introducing the ActiveHybrid X6, featuring an all-new form of power poised to revolutionize the industry. This "full hybrid" combines the awe-inspiring muscle and acceleration of a BMW V-8 gasoline engine with the super efficiency of two electric motors, harnessed by a two-mode transmission. No other hybrid can surpass the ActiveHybrid X6's combination of acceleration, top speed and distance. Under 40 mph, and for 1.5 miles, the electric motors can be used alone "silently and smoothly generating maximum torque from a standing start. Over 40 mph, the combustion engine takes over. Running on a combination of electric and gasoline power, the ActiveHybrid X6 makes the trip from 0 to 60 in 5.4 seconds.<sup>1</sup> Yet even though it is heavier than its combustion-powered sibling, it achieves 20 percent greater efficiency. This is truly the "Best of Hybrid" BMW-style.

<sup>1</sup> BMW AG test results. BMW urges you to obey all posted speed laws and always wear safety belts.

ActiveHybrid



## BMW puts the "high performance" in "hybrid."

**EXPERIENCE STILLNESS WITHOUT STANDING STILL.** At speeds of up to 40 mph, the BMW ActiveHybrid X6 is able to run on electric power alone for brief periods. This occurs automatically and allows you to drive almost noiselessly – and, above all, totally emission-free. You can hardly experience more serene driving pleasure than that.

**ARGUABLY THE BEST BRAKING POWER GENERATOR.** Brake Energy Regeneration – the principle of recuperating braking energy – is as simple as it is intelligent. Each time you apply the brakes or take your foot off the accelerator pedal, kinetic energy is released. Light braking boosts this energy generation further – which, in the ActiveHybrid X6, is made available for electronic braking, as well as stored in a high-performance battery. It can then be reused by the drive system. This saves fuel while also ensuring that the energy gained while braking can be used at any time to enhance overall output.

**ACCELERATING THE EXHILARATION.** The BMW ActiveHybrid boost function is proof that enhanced efficiency can go hand-in-hand with maximum driving pleasure. With this feature, the electric motor gives a temporary – but potent – boost to the combustion engine's output. A key advantage is that it provides spontaneous and powerful output, especially from a standing start, as well as during acceleration and when passing. As a result, the ActiveHybrid X6's performance is significantly enhanced without using more gasoline. Leave it to BMW to increase driving joy while reducing consumption and emissions.

**INTELLIGENT ENERGY MANAGEMENT STARTS BEFORE YOU DO.** The BMW ActiveHybrid models are the first BMW vehicles with an automatic transmission to feature an engine Start/Stop function. Every time you come to a standstill in the BMW ActiveHybrid X6, you actively save fuel, thanks to the Hybrid Start/Stop function. That's because the engine switches off when the car is stationary. This cuts fuel consumption and emissions, especially in city traffic, so you are doing a favor to both your wallet and the environment.

تلفن شبانه روزی: ۰۲۱-۸۸۸۶۲۰۸۵



**Streamline (Style 297)** 20 x 10.0 front, 20 x 11.0 rear light alloy wheels with 275/40 front and 315/35 rear **run-flat performance tires**,<sup>1</sup> standard on the ActiveHybrid X6, reduce unsprung weight for increased performance.



**Exclusivity that runs a blue streak:** contrast stitching, unique to the ActiveHybrid X6 interior, underscores its premium status.



**Special welcome:** chrome door-sill finishers give an eco-friendly greeting with BMW ActiveHybrid lettering.



**Power play:** a graphic in the Control Display shows the source of power flow in real time. Electric power is shown in blue; power from the combustion engine, in red.



**Electric air conditioning compressor:** The electric drive of the air conditioning system runs independently of the combustion engine. You can create a comfortable climate and maintain it while driving on electric power alone – or even when the engine is switched off. This leaves more hybrid energy available for other uses, and full use of all hybrid functions – even during sporty driving and in extreme weather.

**Battery:** The high-performance nickel-metal hydride battery stored over the rear axle is powerful enough for daily use. Yet its compact design leaves ample room to stow four golf bags in the cargo area, as in the other X6 models.

**Two-mode active transmission:** Thanks to this innovative technology, the electric motors and the combustion engine can be used alone or together for optimum performance. Mode 1 provides high-traction, low-speed starts, which are perfect for city driving. Mode 2, which is geared for higher speeds and highways, optimizes performance for maximum efficiency and driving excitement. The 7-speed automatic transmission delivers the BMW high-performance driving experience, with deep reserves of power always on tap. Manual gear changes can also be carried out using steering wheel-mounted gearshift paddles.

**Two electric motors:** These start the engine and, when needed, back up the combustion engine to enhance driving dynamics. In addition, the two electric motors enable the vehicle to drive on electric power alone, which contributes to a substantial cut in consumption and up to a 20 percent reduction in emissions. During Brake Energy Regeneration, the two electric motors also act as generators, storing energy for later use.

<sup>1</sup>Run-flat tires do not come equipped with a spare tire and wheel. Due to low-profile tires, please note: wheels, tires and suspension parts are more susceptible to road hazard and consequential damages. Performance tires not recommended for driving in ice and snow conditions.



All-wheel-drive technology takes an innovative new turn.

Dynamic Performance Control is an advanced driving technology that made its BMW debut on the X6 Sports Activity Coupe.™ Offered in tandem with the road-gripping control of xDrive intelligent all-wheel drive, it creates a new standard for sporty driving pleasure.

Where xDrive all-wheel drive can send available power from the rear to the front, Dynamic Performance Control smoothly apportions available power between the rear wheels. When cornering, Dynamic Performance Control sends more power to the outside rear wheel, enabling the vehicle to "turn in" with less understeer. Minimizing understeer (the tendency to plow through a turn) lets you make tight turns and corner with confidence.

Previously, cornering technologies minimized understeer by applying the brakes to the inside rear wheel, slowing the vehicle down. And unlike other manufacturers' cornering technologies, BMW's Dynamic Performance Control works all the time — even when you take your foot off the accelerator in corners. The result is constant control, experiencing quicker turns and improved handling for optimum performance.

Dynamic Performance Control also works in tandem with BMW's Dynamic Stability Control (DSC), to keep intervention to a minimum when accelerating out of a bend. With Dynamic Performance Control, you can fully appreciate the power and performance of the X6, in virtually any driving situation.



In a right-hand curve, Dynamic Performance Control applies additional power to the left rear wheel, enabling the vehicle to "turn in" faster. Because of the reduced understeer, the vehicle corners with greater control and precision.



If you're driving straight ahead, the power is distributed evenly over both rear wheels for optimum acceleration.



In a left-hand curve, Dynamic Performance Control allocates more driving torque to the right rear wheel, enabling the vehicle to "turn in" with less understeer.

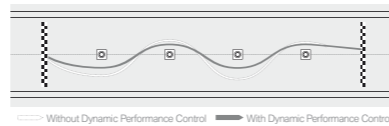

Dynamic Performance Control lets you hug corners more tightly and take them more quickly. In addition to precise control, its seamless distribution of power between the two rear wheels adds greater agility and sportiness for a thrilling driving experience.

## القيادة الذكية والفرمان النشط

Active Steering and Adaptive Drive: Two great ways to tame curves — wherever you find them.

The goal of BMW suspension engineers is to combine sporty handling with optimum body control and ride comfort. In addition to a meticulously tuned chassis, xDrive intelligent all-wheel drive and Dynamic Performance Control, the X6 offers two features that take driving joy even further. Active Steering delivers greater driving enjoyment with even more direct steering when cornering, and greater agility on twisty sections of road. At low and moderate speeds, it takes just two turns of the steering wheel to move the front wheels from far left to far right. When the steering wheel is turned the same amount at higher speeds, the steering ratio gradually changes, providing greater directional stability and more comfortable cruising.

In the Sport Package, Adaptive Drive offers performance-elevating Active Roll Stabilization (ARS) and ride-enhancing Electronic Damping Control (EDC). In corners, the vehicle's body tends to roll, affecting handling characteristics. ARS twists specially designed two-piece anti-roll bars to generate stronger resistance to body roll, keeping the vehicle more level and providing maximum stability and agility. EDC, on the other hand, instantly and continuously adjusts the shock absorbers from the softest to the firmest settings. The result is exceptional riding comfort and fluid handling at all times, during changes in vehicle speed, load or road and driving conditions.

## FarmaSOS.com

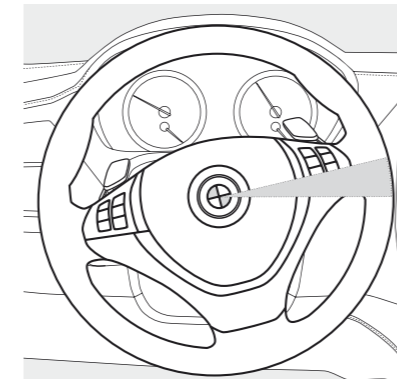

Greater agility at low and medium speeds: With Active Steering, a small turn of the steering wheel translates into a big turn of the front wheels.

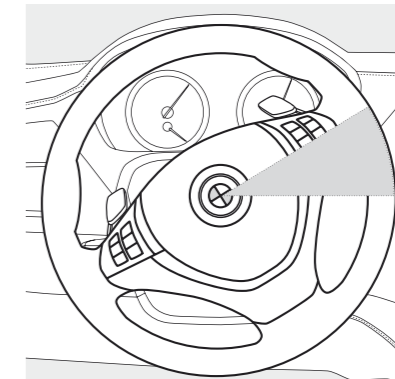

At higher speeds, greater stability and precision: A bigger turn of the steering wheel is needed to turn the front wheels.

For details on the availability of standard and optional features, please refer to the Standard equipment | Optional equipment charts at the back of this brochure.



Adaptive Headlights automatically swivel in the direction you are turning, keeping the road ahead illuminated — even around bends.



In the event of a severe impact, the X6's extremely rigid steel structure is designed to route impact forces around the passenger cell, and deform in a predetermined way. The BMW Advanced Safety System coordinates the activation of airbags, head restraints, safety-belt pretensioners and more, all helping to protect you and your passengers.

Please note: These pictures of airbags are for illustrative purposes only. Depending upon the type of accident, none, some or all airbags may deploy.



When it comes to active and passive safety, the BMW X6 is an overachiever.

As you would expect from a company committed to innovative ideas, the BMW X6 is filled with state-of-the-art safety features. — Active — safety features help you avoid getting involved in an accident. Like all BMWs, the X6 responds to your evasive maneuvers with quick acceleration, nimble handling and fade-resistant braking. During normal driving, if you slam on the brakes, **Dynamic Brake Control** applies the maximum available stopping power. At the same time, the **Adaptive Brake Lights** feature automatically activates additional brake light surfaces, signaling the intensity of your stopping action to those following you. The X6 also includes a wealth of other intelligent active safety features. At night or in poor lighting conditions, **Xenon Adaptive Headlights** provide daylight-like illumination, with headlights that horizontally pivot, lighting up the road around corners. **Hill Descent Control** helps the X6 tackle steep downhill slopes with ease, keeping you at a low, steady speed without riding the brake. The list of X6 active safety features continues — as does your driving peace of mind.

However, should an accident prove unavoidable, the X6's impressive — passive — safety features help protect you and your passengers. BMW's use of high-strength steel creates an extremely sturdy safety cage that, in a severe impact, deforms in a predetermined pattern as the force is routed around the passenger cell. High-strength structural reinforcements are integrated into all four doors to help protect occupants in a side-on collision by reducing intrusions into the passenger area. BMW's supplemental restraint system includes front-seat and seat-mounted airbags for the driver and front passenger, as well as BMW's unique **Head Protection System (HPS)** — a tubular cushion that stays inflated, helping to protect all four occupants' heads by shielding them from shattered glass and debris. The system also helps protect occupants with highly developed and coordinated restraints, such as three-point safety belts and front-seat **Active Head Restraints**.

At the end of the day, BMW believes the only thing that should set your heart beating faster is the pure enjoyment of driving an X6.

See everything at a glance — including the road.

Taking your eyes off the road, even if only to quickly check the speedometer, is a distraction. That's why BMW's Head-up Display is designed to give you important driving information at a glance. Vehicle speed, Check Control warnings, directional arrows from the Navigation system, cruise control information and more are projected clearly onto the windshield in the driver's line of sight. You can also adjust the display for brightness and height, or turn it off. The display lets you keep both eyes focused on the road, so you can navigate traffic while staying informed.

For details on the availability of standard and optional features, please refer to the Standard equipment | Optional equipment charts at the back of this brochure.

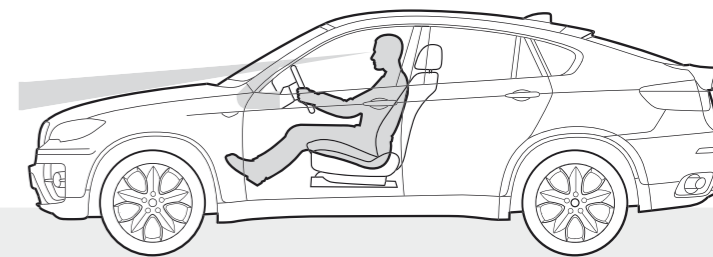

The Head-up Display shows relevant information, such as the car's speed, directly into the driver's field of vision. The height-adjustable display helps keep you focused on what's happening on the road.

فارس خودرو  
تلفن شبانه روزی: ۰۸۵-۸۸۸۶۲۰۲۱

FarmaSOS.com



Select not only the fastest, but also the most interesting roads to reach your destination.

When an upcoming service need is detected, your BMW automatically transmits all relevant information to your BMW service advisor, who then contacts you to arrange an appointment.

Heading for a traffic jam? **Real Time Traffic Information** lets you know in advance and even recommends an alternative route.

Get into a serious accident? Your BMW automatically calls for help and communicates all relevant information.

All drivers sometimes need to stop and refuel. Let a **BMW Assist** Concierge locate and send the address of your preferred gas station and the best local restaurant to your BMW.

Find many more ways how **BMW Assist** makes every trip you take more enjoyable.

Need an address or telephone number? **BMW Search** uses Google Maps to find them, then your Navigation system guides you there.

امداد خودرو فارما

تلفن شماره روزی: ۰۲۱-۸۸۶۲۰۸۵

FarmaSOS.com

## Two for the road: Navigation and BMW Assist™

When you're far from home or just in the next town it's easy to find your way with confidence and peace of mind with the convenient features and services available on your BMW.

**BMW Assist Safety Plan** gives you peace of mind knowing that a friendly response specialist is there to help you 24/7, at the touch of a button. Enjoy four years of a wide range of services at no additional charge. The Safety Plan includes Automatic Collision Notification, Emergency Request (SOS), TeleService, Enhanced Roadside Assistance, Door Unlock, Stolen Vehicle Recovery, Customer Relations and MyInfo.



The optional **BMW Assist Convenience Plan** adds personalized Directions, Traffic and Weather reports, BMW Search and Concierge services to not only recommend restaurants and hotels, but then also send the destination address and phone number right to your BMW. You can make up to four operator-assisted calls per year with Critical Calling if your cell phone is not available or its battery is discharged.

**MyInfo** allows you to send business locations and street addresses to your BMW from your computer. Destinations and phone numbers can be accessed and exported to your Navigation system for immediate route guidance, while you can call the destination with your Bluetooth® linked phone.



**BMW Search™** allows online access to up-to-date fuel prices, the latest weather forecasts, Bloomberg stock indices and the powerful reach of the Google Maps™ database delivered on your control display inside your vehicle.



In most large cities, **Real Time Traffic Information** makes you aware of traffic congestion before you encounter it. This feature displays and describes current local traffic information on your control display; in case of congestion, it suggests alternate routes.



BMW is the first automobile manufacturer to offer **BMW Trips**, giving you the opportunity to directly transfer personally planned trips from the Internet to your Navigation system via a USB memory stick. (Delayed availability.)





The pages in this section of the brochure show available colors and materials for the BMW X6. Use these samples to compare paint, upholstery, trim colors and combinations. Please note that these samples are representations; they are not exact reproductions. To see the actual colors, visit your local BMW SAV® center. They will be happy to show you original samples and assist you with special requests. All paint colors are standard.

[bmwusa.com/byo](http://bmwusa.com/byo)

### Paints

300 Alpine White Non-metallic

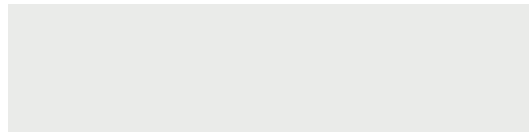

668 Jet Black Non-metallic



354 Titanium Silver Metallic

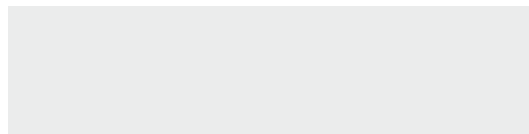

A14 Mineral Silver Metallic

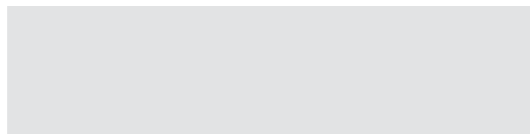

A52 Space Gray Metallic



A81 Tasman Green Metallic



A35 Monaco Blue Metallic



A76 Deep Sea Blue Metallic



A82 Vermilion Red Metallic



475 Black Sapphire Metallic



Standard  Optional

### Upholsteries

LUB4 Sand Beige Nevada Leather



LUCX Oyster Nevada Leather



LUCH Chateau Nevada Leather<sup>1</sup>

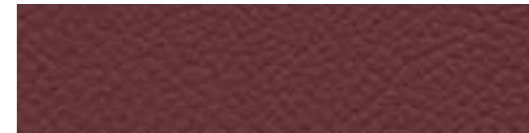

LUD3 Saddle Brown Nevada Leather<sup>1</sup>



LUSW Black Nevada Leather

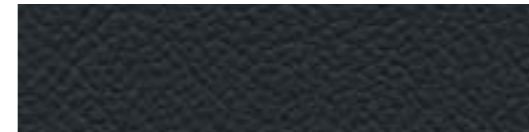

LVB4 Sand Beige Perforated Nevada Leather<sup>2</sup>



LVSW Black Perforated Nevada Leather<sup>2</sup>

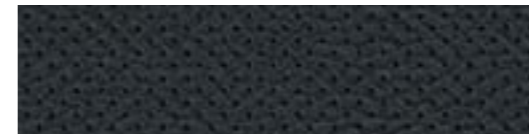

NAB4 Sand Beige Nappa Leather<sup>3</sup>

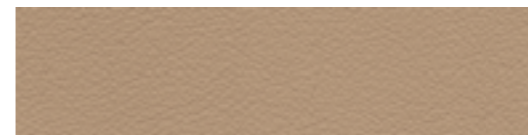

NASW Black Nappa Leather<sup>3</sup>



GHCH Chateau Alcantara/Leather combination<sup>4</sup>



GHSW Black Alcantara/Leather combination<sup>4</sup>



Leather upholstery includes all seating surfaces, headrests, door armrests and front center console armrest.

<sup>1</sup> X6 xDrive35i: requires optional multi-contour seats.

<sup>2</sup> No-cost option; requires and must be ordered with optional Active Ventilated Seat Package.

<sup>3</sup> Optional; includes Nappa Leather-covered dashboard and center console. X6 xDrive35i: requires optional multi-contour seats.

<sup>4</sup> No-cost option; requires and must be ordered with optional sport seats.

امداد خودرو فارما

تلفن شبانه روزی: ۰۲۱-۸۸۸۶۲۰۸۵

FarmaSOS.com

**Recommended color combinations**

Materials	Nevada Leather <sup>1</sup>					Perforated Nevada Leather <sup>2</sup>		Nappa Leather <sup>3</sup>		Alcantara/Leather combination <sup>4</sup>	
	Sand Beige	Oyster	Chateau <sup>5</sup>	Saddle Brown <sup>5</sup>	Black	Sand Beige	Black	Sand Beige	Black	Chateau	Black
<b>Upholstery colors</b>											
<b>Exterior colors</b>											
<b>300</b> Alpine White Non-metallic		•	•	•	•	•	•	•	•	•	•
<b>668</b> Jet Black Non-metallic		•	•	•	•	•	•	•	•	•	•
<b>354</b> Titanium Silver Metallic			•	•			•		•	•	•
<b>A14</b> Mineral Silver Metallic		•	•	•			•		•	•	•
<b>A52</b> Space Gray Metallic			•	•			•		•	•	•
<b>A81</b> Tasman Green Metallic		•	•		•	•	•	•	•		•
<b>A35</b> Monaco Blue Metallic		•	•		•	•	•	•	•		•
<b>A76</b> Deep Sea Blue Metallic		•	•		•	•	•	•	•		•
<b>A82</b> Vermilion Red Metallic		•	•			•	•	•	•		•
<b>475</b> Black Sapphire Metallic		•	•	•	•	•	•	•	•	•	•
<b>Interior trims</b>											
<b>4AD</b> Brushed Aluminum											
<b>4AZ</b> Dark Bamboo Wood											
<b>4BN</b> Ash Grain Wood											

د خودرو فارما

تلفون شماری: ۰۲۱-۸۸۸۶۲۰۸۵

FarmaSOS.com

**Interior trims**

**4AD** Brushed Aluminum



**4AZ** Dark Bamboo Wood



**4BN** Ash Grain Wood



All interior trims are available as no-cost options .

All paint colors are standard, and all interior trims are no-cost options.

<sup>1</sup> Standard.

<sup>2</sup> No-cost option; requires and must be ordered with optional Active Ventilated Seat Package.

<sup>3</sup> Optional; includes Nappa Leather-covered dashboard and center console.

X6 xDrive35i: requires optional multi-contour seats.

<sup>4</sup> No-cost option; requires and must be ordered with optional sport seats.

<sup>5</sup> X6 xDrive35i: requires optional multi-contour seats.

For details on the availability of standard and optional features, please refer to the **Standard equipment** | **Optional equipment** charts at the back of this brochure.



### Heart of fire.

Outside: timeless Jet Black paint. Inside: the glow of red Chateau Nevada Leather against the black dash and carpeting. Like the fire within the coal, this X6 is visually smoldering, ready to ignite the passion of anyone who comes near. Optional 20" Y Spoke (Style 214) wheels are available with the optional Sport Package.



امداد خودرو باران

تلفن شبانه روزی: ۰۲۱-۸۸۸۶۲۰۸۵

FarmaSOS.com



The flexible cargo space of the X6, with 60/40 split-folding rear seats and available pass-through, maximizes your hauling possibilities.



When equipped with the Premium Package, two lashing rails with four sliding lashing eyes, as well as additional lighting, make it easy to see and secure cargo safely and quickly.



With both rear seats lowered, the X6 provides almost 60 cu. ft. of usable storage space.

### Plenty of room for all that matters.

BMW created the X6 with a spacious, flexible cargo area that carries your gear with ease. 60/40 split-folding rear seats and a retractable cargo cover come standard; an available pass-through with ski bag helps protect skis, poles and other long items, as well as the interior. A Storage package, included in the Premium Package, adds additional lighting and two lashing rails with four sliding lashing eyes. So feel free to bring along some friends and their gear — the X6 can handle it.

For details on the availability of standard and optional features, please refer to the Standard equipment | Optional equipment charts at the back of this brochure.

ایجاد خودرو فارما  
تلفن شماره روزی: ۰۸۵ ۰۱۶۲ ۸۷۸۲۰۲۱  
FarmaSOS.com



■ **Xenon Adaptive Headlights** optimize road illumination when the X6 enters a turn or corner, helping to enhance visibility when driving at night. Sensors continuously monitor the angle of the steering wheel to determine the direction in which the X6 is heading. The outer headlights swivel accordingly, up to 15 degrees left or right.

**Xenon low- and high-beam headlights** illuminate the road ahead and to the side with brilliant clarity. An auto-leveling feature adjusts for varying passenger and cargo loads. The **Corona headlight-rings** that circle both headlights and high beams also act separately as Daytime Running Lights and parking lights.



■ **Halogen free-form foglights** are cleanly integrated into the front air dam, illuminating the road ahead in bad weather and poor visibility. They also provide another practical feature: **Cornering Lights**. When the system senses you are making a turn  based on your steering angle and speed  a reflector mechanism in the foglight housing casts additional lighting up to 90 degrees in the direction of the turn. This enhances visibility and recognition of people and objects.



■ **Adaptive Brake Lights** increase vehicle visibility and signal the intensity of your braking action, thereby warning following drivers to brake quickly.



■ **Dual rectangular-shape chrome exhaust tips** are strikingly positioned in the rear fascia of the X6 xDrive50i. With their bold styling, these exhaust tips identify this X6 as the model with the V-8 engine.



■ **Dual circular-shape chrome exhaust tips**, integrated into the X6 xDrive35i's rear fascia, stand out and add an attractive touch to the exhaust system.



■ **Star Spoke (Style 232)** 19 x 9.0 light alloy wheels with 255/50 **run-flat<sup>1</sup> all-season tires** are standard on the X6 xDrive35i.



■/□ **V Spoke (Style 257)** 19 x 9.0 light alloy wheels with 255/50 **run-flat<sup>1</sup> all-season tires** are standard on the X6 xDrive50i and optional on the ActiveHybrid X6.

البراد خودرو فارما

تلفن شبانه روزی: ۰۲۱-۸۸۸۶۲۰۸۵



■ **Rain sensor** uses infrared light to measure the amount of rain. When the wipers are in the  intermittent  mode, the rain sensor automatically adjusts the windshield-wiping interval as needed. **Automatic headlight control** (not shown), included with rain sensor, activates headlights by means of a sensor that responds to darkness.



■ Signature **kidney grille** sits over the special intake grille, underscoring the X6's rugged stance. (Kidney grille has Black finish on X6 xDrive35i; Titanium finish on X6 xDrive50i.)



□ **Power-adjustable folding exterior side-view mirrors**, in matching body color, automatically dim when reflecting bright lights, helping to eliminate glare when driving at night. (Included in Premium Package.)



□ **Running boards**, designed to add to the X6's overall visual appeal, make it easy for passengers to enter and exit the X6 with comfort.

FarmaSOS.com



□ **Star Spoke (Style 212)** 19 x 9.0 light alloy wheels with 255/50 **run-flat<sup>1</sup> all-season tires** are included in the X6 xDrive35i Sport Package and Sport Activity Package.



□ **Star Spoke (Style 258)** 19 x 9.0 light alloy wheels with 255/50 **run-flat<sup>1</sup> all-season tires** are included in the X6 xDrive50i Sport Package and Sport Activity Package.



□ **Y Spoke (Style 214)** 20 x 10.0 front, 20 x 11.0 rear light alloy wheels with 275/40 front and 315/35 rear **run-flat<sup>1</sup> performance tires<sup>2</sup>** are available as an option when ordering the X6 xDrive35i Sport Package and Sport Activity Package. (Not available on X6 xDrive50i or ActiveHybrid X6.)



□ **Star Spoke (Style 259)** 20 x 10.0 front, 20 x 11.0 rear light alloy wheels with 275/40 front and 315/35 rear **run-flat<sup>1</sup> performance tires<sup>2</sup>** are available as an option when ordering the X6 xDrive50i Sport Package and Sport Activity Package. (Not available on X6 xDrive35i.)

<sup>1</sup> Run-flat tires do not come equipped with a spare tire and wheel.

<sup>2</sup> Due to low-profile tires, please note: wheels, tires and suspension parts are more susceptible to road hazard and consequential damages. Performance tires not recommended for driving in ice and snow conditions.



■ **Three-spoke leather-wrapped multi-function sport steering wheel**, featuring power tilt/telescoping adjustments, lets you keep both hands on the steering wheel while adjusting both the audio and a BMW-approved, Bluetooth® enabled mobile phone.



■/□ **Voice command** lets you verbally control numerous Navigation system functions and dial phone numbers hands-free. The Voice command button must be pressed before each use, so conversations won't accidentally activate the phone or other systems. (Voice command is part of the Navigation system.)



■/□ **Navigation system** features a high-resolution, glare-free monitor, and uses GPS satellites in conjunction with data stored on an internal hard drive. Includes 3-D daytime and nighttime maps, zoom, travel planner and an Assistance Window. The system provides Real Time Traffic Information on potential traffic problems and solutions. The hard drive offers 12 GB of space that can hold up to 2,000 of your favorite songs.



□ **Rear-view camera with Top View** is activated automatically by shifting into reverse gear, or manually by pressing the parking-assist button. The color display shows a real camera image that may include **static** and **track** lines to help you when backing up or parallel parking.



■ **Park Distance Control** uses eight sensors **four in the front, four in the rear** to help you judge how close you are to other cars and unseen objects when parking. The warning beeps come faster as the bumper approaches the object, turning into a constant tone when the distance is less than 12 inches.



■ **Dynamic Cruise Control** lets you store and keep to a chosen speed above 20 mph, and automatically applies the brakes downhill. It is activated via the left-hand steering column switch, and deactivated by applying the brakes or via the switch.

Cruise control is not a substitute for the driver's own responsibility in adjusting speed and otherwise controlling the vehicle. Due to road, traffic and visibility conditions, the driver must decide whether and how the system is used.

تلفن شبانه روزی: ۰۲۱-۸۸۸۶۲۰۸۵



■ **Engine Start/Stop button and remote key** control the engine. First, insert the remote key into the starter switch slot. After the electronic identification system confirms that it is the correct remote key, you can start (or later, turn off) the engine by pressing the Start/Stop button. (Foot must be on brake in order to start.)



■ **iDrive Controller**, which is conveniently located on the center console, is the central command element for the iDrive system and can be rotated, pushed and tilted to operate various functions via the Control Display. Additionally, four frequently selected menus **CD, radio, Navigation system and telephone** can be called up using direct menu-control buttons.



■ **Six programmable memory buttons** offer convenient storage of your most frequently accessed iDrive settings, such as favorite radio stations, Navigation system addresses, phone numbers (when equipped with a BMW-approved Bluetooth enabled mobile phone), and more.



■ **Glare-free Control display screen**, linked with the iDrive and Navigation system, renders clear images and text. The surface of this new-generation display is equipped with transreflective technology, ensuring legibility by automatically making adjustments to the brightness or background lighting in bright- or poor-light conditions.



■ **Sport Automatic transmission** provides extremely fast synchronized shifting, whether performed by the Automatic shift mode or by means of the race-inspired steering wheel-mounted paddle shifters.



■ **Electromechanical parking brake with Automatic Hold** keeps the vehicle stationary whenever the vehicle comes to a stop, then releases the brake when the driver steps on the accelerator pedal.



■ **Front cupholders** integrated into the center console are located within convenient reach of the driver and front passenger.



■ **Front armrest** with integrated storage compartment folds up to allow access to the optional iPod® and USB adapter port (shown on page 50).



□ **Head-up Display** projects important travel information, such as current speed, on the windshield directly in the driver's line of vision. Directional arrows from the Navigation system and Check Control data can also be displayed.



□ **Ten-way power front sport seats** with two-way manual thigh support adjustment and driver's seat memory system make the X6 driving experience more enjoyable. Thanks to specially padded, highly contoured side bolsters, sport seats provide optimum lateral support during tight cornering, while remaining exceptionally comfortable when driving over long distances. The seats have power adjustments for seat height, backrest angle, seat bottom angle, forward/backward position and head-restraint height; includes manual adjustment for thigh support.



■/□ **20-way power multi-contour front seats** conform to your body to provide optimum support and exceptional comfort over long distances. In addition to horizontal, vertical and angled adjustments, seats include an articulated upper backrest, backrest width, Comfort headrest (two-way power, two-way manual (relax headrest!)), and four-way power-adjustable lumbar support. Both driver's and front-passenger's seats include memory function.

فارس خودرو فارما

تلفن شبانه روزی: ۰۲۱-۸۸۸۶۲۰۸۵



■ **Dynamic Performance Control Display** shows the percentage of drive force apportioned between the front and rear axles, as well as between the left and right rear wheels.



■ **BMW anti-theft AM/FM stereo CD/MP3 player** includes Radio Data System, Auto-Store, and 3-channel FM diversity antenna; reads/displays song title.  
 ■ **HD Radio™** receives free, digital AM/FM broadcasts in clear, static-free sound; multicast FM stations, and innovative data services.



■ **Kneepads** along the sides of the center console provide greater comfort and grip for the driver and front passenger's knees especially during quick, sharp turns.



■ **Storage space** abounds throughout the cabin in the front center console, in door storage pockets and in the rear cabin.



■ **Rear cabin seats** securely and comfortably hold two passengers. The ergonomic belt system includes center-mounted buckles, two three-point safety belts and head restraints.



■ **Power seat adjustments** allow customized comfort for driver and front passenger. On the driver's side, a two-driver memory system automatically adjusts the driver's seat, side-view mirrors and the steering wheel position.



□ **Heated front seats** are a welcome feature in cooler weather. With the touch of a button, driver and front passenger can individually select from three heat settings.



■ **Two-way power glass moonroof** with remote, expanded one-touch operation, slides back or tilts up to let in as much fresh air and sky as you like, while a wind deflector helps keep the wind out. Includes a sliding interior sunshade.



■ **60/40 split-folding seat** gives you the flexibility to carry any combination of cargo and passengers.



■ **Retractable cargo cover** keeps contents of the cargo area hidden from sight. When not in use, it can easily be removed.



■ **12V power outlets** are included in the front and rear passenger areas, as well as in the cargo area.



□ **Rear-seat entertainment** system lets passengers in the rear cabin watch DVDs or listen to their choice of CDs through headphones or the vehicle speaker system. The system features a fold-down 8-inch color screen and can be controlled via a wireless remote control or manually by the rear-seat passengers.

**Premium Package**

The X6 Premium Package enhances your driving experience every day. Soothe your back with the ergonomic comfort of lumbar support, and your eyes with the ambient lighting package, as well as automatic-dimming rear- and side-view mirrors that cut headlight glare. You'll enjoy the convenience of a cargo-area Storage package, a Universal garage-door opener, and a digital compass to help keep you on track to your driving destination. The Premium Package also includes the roadgoing peace of mind of BMW Assist<sup>1</sup> with Bluetooth wireless communication system.



**Ambiance lighting package** includes lights in the exterior door handles that radiate downward whenever the doors are unlocked. They illuminate the area outside the doors for approximately 20 seconds to enable safe vehicle access in the dark. Also included are rear reading lights, rear footwell illumination, and ambient interior lighting.

تلفن شبانه روزی: ۰۲۱-۸۸۸۶۲۰۸۵

FarmaSOS.com



■ **Rear cupholders** are integrated into the rear armrest.



□ **BMW Assist<sup>1</sup>** and Bluetooth<sup>®</sup> system offers hands-free calling through your BMW-approved Bluetooth phone. The BMW Assist Safety Plan is included for 4 years, providing Automatic Collision Notification, Emergency Request, Roadside Assistance, Door Unlock, Stolen Vehicle Recovery, TeleService and more. The optional Convenience Plan offers Directions, Traffic, Weather, Critical Calling and Concierge services.

<sup>1</sup>See page 66 for details of standard and optional services available with BMW Assist.™



□ **Comfort Access system** offers an even greater degree of convenience: keyless access to your vehicle. Simply carrying the remote key in a pocket allows you to unlock the doors by touching the door handle. You can also turn the engine on or off by pressing the Start/Stop button without inserting the remote key. (Foot must be on brake in order to start.)



**Lumbar support** for front seats adds four-way power-adjustable comfort for the lower back. Lumbar support can be adjusted up/down and in/out.



**Storage package** adds practical extras: additional lighting and two lashing rails with four sliding lashing eyes.



The **automatic-dimming inside rear-view mirror** darkens in response to the bright headlights of vehicles behind you. The easy-to-read **digital compass**, integrated into the mirror, is a convenient way to constantly keep your bearings while driving. A **three-button Universal garage-door opener** can be programmed to open garage doors and activate various remote convenience functions.

For details on the availability of standard and optional features, please refer to the Standard equipment | Optional equipment charts at the back of this brochure.



**Active Ventilated Seat Package<sup>1</sup>**

For the ultimate in comfort, BMW offers the optional Active Ventilated Seat Package. Both the driver and front passenger enjoy highly supportive 20-way power multi-contour front seats upholstered in Perforated Nevada Leather. The internal sections of the seats contain multiple fans that provide forced ventilation through a permeable, "sandwich" seat layer. In cooler weather, temperature-adjustable air flows through the seat and seat-back, providing welcome heating. In warmer weather, air circulates through the seat and seatback, helping to dissipate perspiration. The Active function in the driver's seat raises and lowers the left and right halves of the seat, helping to relieve fatigue during extended trips. By combining multi-contour support, ventilation and Active driver support, BMW's Active Ventilated Seat Package adds to your long-distance traveling comfort and pleasure.

<sup>1</sup> Requires optional Perforated Nevada Leather and optional Cold Weather Package or heated front seats.



**20-way power multi-contour front seats** conform to your body to provide optimum support and exceptional comfort over long distances. In addition to horizontal, vertical and angled adjustments, multi-contour seats include an articulated upper backrest, backrest width, Comfort headrest (two-way power, two-way manual "relax headrest"), and four-way power-adjustable lumbar support. Both driver's and front-passenger's seats include memory function.



**Active driver's seat** helps decrease stiffness or fatigue on long trips. When activated, the driver's seat surface is continuously and imperceptibly raised and lowered from side to side, keeping your spine in motion and exercising various support muscles.



**Front seat ventilation** gently blows warm air or cool air through the microperforations in the leather to help keep driver and front passenger comfortably dry in hot weather, and warm in colder weather.

**Cold Weather Package**

Whether it's driving to the slopes, or just running errands around town, there's nothing like the feeling of three-stage heated front seats on a cold morning. Add the pleasure of a heated steering wheel on those blustery days, and you are truly ready for whatever nature has in store. Retractable, high-intensity headlight washers help maintain optimal visibility in all weather and driving conditions, and the ski bag is a must for protecting skis, poles and other long objects.



**Retractable, high-intensity headlight washers** help keep lights clean of ice, mud, road salt and other coatings, for maximum road lighting and enhanced driving visibility.



**Ski bag** allows for clean transport of up to four pairs of skis with up to four occupants in the vehicle. Whenever the ski bag is not in use, it remains stored conveniently and discreetly behind the rear center armrest.



**Heated rear seats** are a welcome feature for left and right rear-seat occupants in cooler weather. With the touch of a button, passengers can individually select their preferred level of warmth.



**Heated steering wheel** is a feature that, like heated seats, becomes a "must-have" once it's experienced. The heating switch is conveniently located on the multi-function steering wheel.

تلفن شبانه روزی: ۰۲۱-۸۸۸۶۲۰۸۵

FarmaSOS.com

**Premium Sound Package**

Whatever your preference in music, you can enjoy the extraordinary listening experience of the Premium high-fidelity audio system and six-disc DVD changer. An equalizing method used in professional studio applications has been fitted into the X6, and the integration of 16 speakers with elaborate Digital Signal Processing (DSP) leads to optimal sound reproduction at all seating locations. And, whether your choice of music ranges from Bluegrass to Beethoven, an iPod® and USB adapter interface enables you to scroll through and select your favorites.



**Premium high-fidelity system** is a multi-channel system that outputs reproduction of the surround information contained in the stereo signal in a nine-channel format (seven medium-high range channels and two central bass channels). The 16-speaker system is comprised of one center bass speaker sub-woofer below each front seat; one mid-range and one high-range speaker each in the door trim panels; one mid-range and one high-range speaker each in the D-pillar; one mid-range and one high-range speaker in the instrument panel (center channel); and a digital amplifier with nine channels and 600-watt output (7x50 watts + 2x125 watts). All speakers are fitted with very strong, yet compact Neodymium drives. The system also compensates for driving noise in smooth steps by speed-dependent equalizing in the low range.

**Rear Climate Package**

Let your rear-seat passengers create their own oasis of comfort. With the Rear Climate Package, all occupants, both front and rear, enjoy individual climate control settings. Each can customize the temperature and airflow rate to their own preferences. Privacy glass and manual rear side sunshades reduce the heat and glare of the sun, helping to keep the cabin cool and glare-free while increasing privacy.



**Privacy glass** in the rear and rear side windows enhances passenger privacy, while it reduces sun glare and interior heat.



**DVD changer**, located in the glovebox, accommodates six discs, as well as single-feed. The easily accessible six-disc changer supports multi-channel sources, and plays compressed audio formats (MP3, WMA, etc.). When equipped with the Navigation system, the DVD changer can also play video on the iDrive screen when the vehicle is stationary.



**iPod and USB adapter** lets you scroll through and select music by using the vehicle's radio controls, the multi-function steering wheel buttons or the iDrive Controller. Music titles are displayed on the radio or screen. **Auxiliary input port** lets you connect an external audio source, such as an iPod or MP3 player.

امداد خودرو فارس  
تلفن شبانه روزی: ۰۲۱-۸۸۸۶۲۰۸۵

FarmaSOS.com



**Four-zone climate control** lets occupants, both front and rear, select individual temperature and fan settings.



**Rear side sunshades** keep the sun's heat and glare away from the rear cabin while maintaining privacy. When not in use, these manually adjustable sunshades conveniently disappear into the side doors.

**Sport Package / Sport Activity Package**

The X6 was made for sporty driving. Make the most of its fun-loving capabilities by adding the optional Sport Package or Sport Activity Package to the X6 xDrive35i or X6 xDrive50i. High-gloss shadowline trim and 19" light alloy wheels with run-flat<sup>1</sup> all-season tires present an impressive sight. To enhance driving performance, the Sport Package includes Adaptive Drive with Active Roll Stabilization and Electronic Damping Control. This complements the already stiff suspension to provide more precise and agile handling. Front sport seats are designed to hold you secure in tight turns; an Anthracite headliner completes the sporty interior. Optional 20" light alloy wheels with mixed-size run-flat<sup>1</sup> performance tires<sup>2</sup> are available on both X6 models.



**10-way power front sport seats** with two-way manual thigh support adjustment and driver's seat memory system make the X6 driving experience more enjoyable. Side bolsters on the seats cradle you comfortably over long distances, while holding you firmly in place during sporty driving maneuvers.



**High-gloss shadowline trim** gives the front and rear side-window frames and door-sill trim strips a sportier look.



**Star Spoke (Style 259)** 20 x 10.0 front, 20 x 11.0 rear light alloy wheels with 275/40 front and 315/35 rear **run-flat<sup>1</sup> performance tires<sup>2</sup>** are available as an option when ordering the X6 xDrive50i Sport Package and Sport Activity Package. (Not available on X6 xDrive35i.)



**Star Spoke (Style 258)** 19 x 9.0 light alloy wheels with 255/50 **run-flat<sup>1</sup> all-season tires** are included in the X6 xDrive50i Sport Package and Sport Activity Package. (Not available on X6 xDrive35i.)



**Star Spoke (Style 212)** 19 x 9.0 light alloy wheels with 255/50 **run-flat<sup>1</sup> all-season tires** are included in the X6 xDrive35i Sport Package and Sport Activity Package. (Not available on X6 xDrive50i.)



**Y Spoke (Style 214)** 20 x 10.0 front, 20 x 11.0 rear light alloy wheels with 275/40 front and 315/35 rear **run-flat<sup>1</sup> performance tires<sup>2</sup>** are available as an option when ordering the X6 xDrive35i Sport Package and Sport Activity Package. (Not available on X6 xDrive50i.)

<sup>1</sup> Run-flat tires do not come equipped with a spare tire and wheel. However, a spare tire and wheel can be ordered as an option in X6 xDrive35i and X6 xDrive50i.

<sup>2</sup> Due to low-profile tires, please note: wheels, tires and suspension parts are more susceptible to road hazard and consequential damages. Performance tires not recommended for driving in ice and snow conditions.

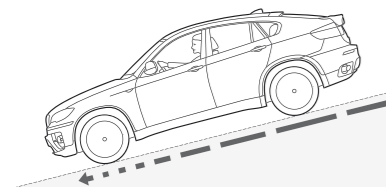

**Hill Descent Control (HDC)** helps the X6 drive down steep hills without having to ride the brake. By pressing the HDC button, the system keeps the X6's speed under control automatically.

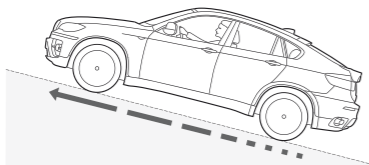

**Start-off Assistant** keeps the X6 from rolling either backward or forward when you're stopped on a hill. The system momentarily holds the X6's position as you take your foot off the brake pedal and start driving.

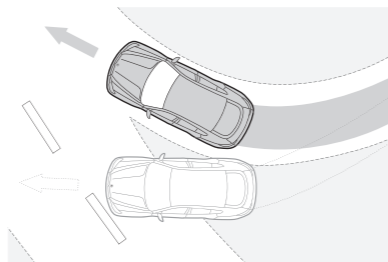

**Dynamic Stability Control** provides remarkable tenacity on slippery road surfaces. If the system senses over- or understeer, it modulates engine power and can apply brakes individually to help keep the vehicle under control and going in the intended direction.

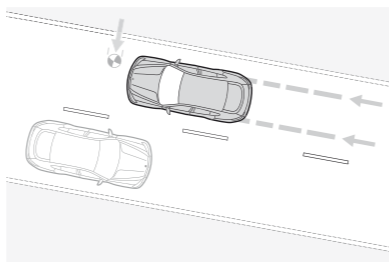

**Dynamic Brake Control** senses panic braking maneuvers, and immediately builds up maximum brake pressure. This cuts down the overall braking distance significantly. When Dynamic Brake Control is activated, the system also deploys **Adaptive Brake Lights**. These increase vehicle visibility and signal the intensity of your braking action, thereby warning following drivers to brake quickly.

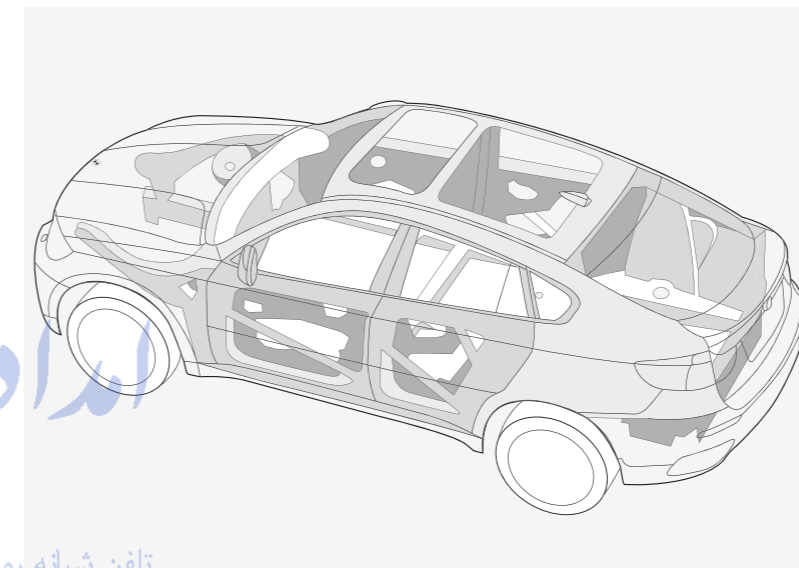

**Extremely rigid body** creates a protective safety cell that directs severe impact forces around the passenger compartment. Thanks to BMW's intelligent lightweight design and the use of high-strength steels, the interior passenger compartment is surrounded by a stronger shell than was previously possible to construct.

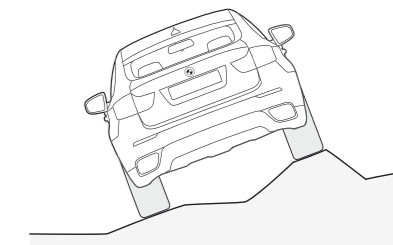

**Rollover sensor**, linked with the Dynamic Stability Control system, quickly detects when the X6 is at risk of rolling over and assists the driver in maintaining control of the vehicle. If a rollover is imminent, the airbags and the safety-belt pretensioners are immediately triggered to provide additional occupant protection.

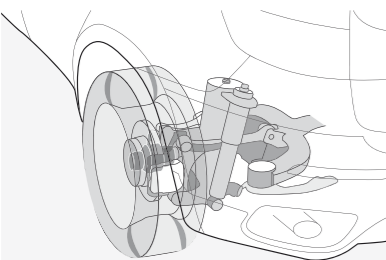

**Tire Pressure Monitor** is an electronic control system designed to warn the driver if there is a sudden and irregular loss of tire pressure. Should the target pressure of a tire fall below 25%, a warning light alerts the driver.

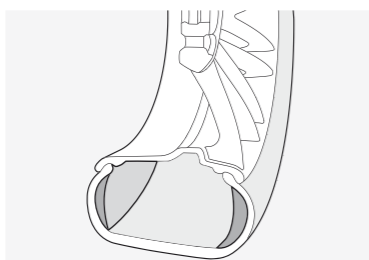

**Run-flat tires** allow speeds of up to 50 mph and travel from 30 to 150 miles after a loss of air pressure, depending on the passenger load and weight of articles being transported.<sup>1</sup> In situations that would normally result in a flat tire, reinforced sidewalls help prevent the tires from collapsing or loosening from the rim. In the event of a decline in tire pressure, the driver is warned by the **Tire Pressure Monitor**.

<sup>1</sup>Please see your X6 Owner's Manual for more information detailing allotted miles to travel and load weight rules.

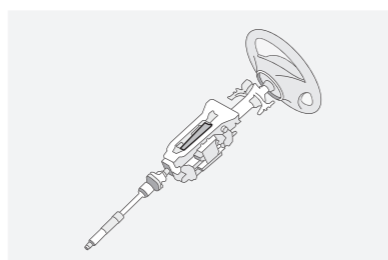

**Telescoping steering column system.** In a collision, a section absorbs a portion of the impact force and collapses, helping to protect the driver.

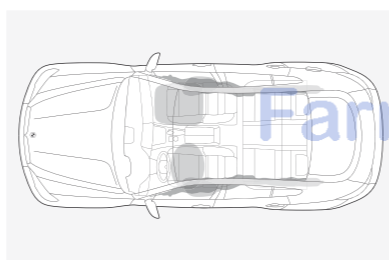

In the event of a collision, only the **airbags** that are needed are deployed. This includes front airbags with advanced deployment technology, front side-impact airbags, and front and rear HPS (Head Protection System).

Note: These pictures of airbags are for illustrative purposes only. Depending upon the type of accident, none, some or all airbags may deploy.

تلفن شبانه روزی: ۰۲۱-۸۸۸۶۲۰۸۵

FarmaSOS.com

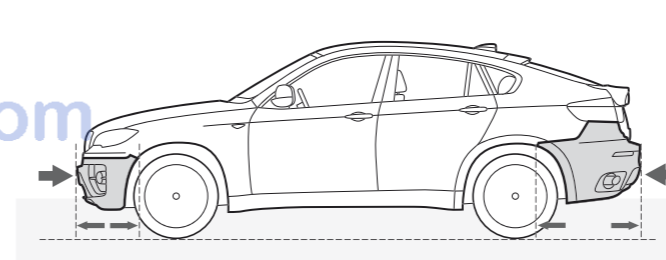

**Impact-absorbing bumpers** and compressible crush tubes front and rear help absorb the force of impact in collisions up to nine mph, minimizing damage to the vehicle's body and simplifying repairs. Only at higher impact speeds do structural supports begin to deform, dissipating impact energy to help protect occupants.

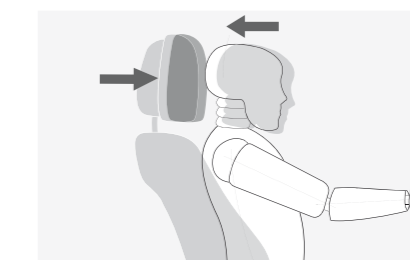

**Active Head Restraints** in the front seats reduce the risk of whiplash or neck/head/spine injury. When sensors detect a rear-end collision, the headrests rapidly and automatically pivot forward, supporting the driver's and front-seat occupant's heads.

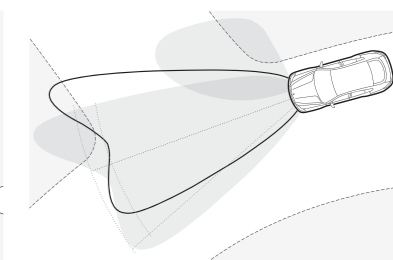

**Xenon Adaptive Headlights** with Corona headlight-rings automatically swivel to follow the curves of the road. The system uses data from on-board sensors and the steering wheel angle to determine the vehicle's direction, then adjusts the headlights accordingly, for excellent nighttime vision. **Cornering Lights**, integrated into each of the foglight housings and activated whenever the X6's turn-signal indicators are used, project additional lighting and increased illumination in the direction of the turn.

Performance and efficiency	X6 xDrive35i	X6 xDrive50i	ActiveHybrid X6
3.0-liter dual overhead cam (DOHC), 24-valve inline 300-hp 6-cylinder engine with Advanced Turbo technology, piezo direct fuel injection, and Double-VANOS steplessly variable valve timing	●		
4.4-liter, 32-valve 400-hp V-8 engine with Advanced Turbo technology, piezo direct fuel injection, 4 overhead camshafts, and Double-VANOS steplessly variable valve timing		●	
ActiveHybrid combustion engine: 4.4-liter, 32-valve 400-hp V-8 engine with Advanced Turbo technology, piezo direct fuel injection, 4 overhead camshafts, and Double-VANOS steplessly variable valve timing; 90-hp electric motor A and 84-hp electric motor B with power split drive mode (output branched concept) for power conversion			●
6-speed Sport Automatic transmission with Adaptive Transmission Control (ATC), Sport and STEPTRONIC Manual shift modes, and steering wheel-mounted paddle shifters	●	●	
7-speed Sport Automatic transmission with Adaptive Transmission Control (ATC), Sport and STEPTRONIC Manual shift modes, and steering wheel-mounted paddle shifters			●
2-mode active transmission with an electrical continuously variable mode (ECVT), optimized for low and high speeds, and a fixed transmission ratio			●
Performance upgrade (requires Sport Package or Sport Activity Package)	○	○	

Handling, ride and braking	X6 xDrive35i	X6 xDrive50i	ActiveHybrid X6
xDrive all-wheel-drive system	●	●	●
Dynamic Stability Control (DSC), including Brake Fade Compensation, Start-off Assistant, Brake Drying, and Brake Stand-by features, with Dynamic Traction Control (DTC), and Dynamic Brake Control	●	●	●
Dynamic Performance Control	●	●	●
Hill Descent Control (HDC)	●	●	●
Double wishbone front suspension	●	●	●
Lightweight multi-link integral rear suspension	●	●	●
Engine-speed-sensitive power steering	●	●	●
4-wheel anti-lock ventilated disc brakes; electronic front/rear proportioning	●	●	●
Self-leveling suspension			●
Active Steering with Servotronic power assist (requires Sport Package)	○	○	
Adaptive Drive: includes Active Roll Stabilization and Electronic Damping Control	□	□	

- Standard
- Optional
- Included in Sport Package
- ▣ Included in Sport Activity Package
- ★ Included in Cold Weather Package
- △ Included in Premium Sound Package

<sup>1</sup> Run-flat tires do not come equipped with a spare tire and wheel. However, a spare tire and wheel can be ordered as an option in X6 xDrive35i and X6 xDrive50i.

<sup>2</sup> Due to low-profile tires, please note: wheels, tires, and suspension parts are more susceptible to road hazard and consequential damage. Performance tires not recommended for driving in snow and ice conditions.

Exterior	X6 xDrive35i	X6 xDrive50i	ActiveHybrid X6
Star Spoke (Style 232) 19 x 9.0 light alloy wheels, and 255/50 run-flat <sup>1</sup> all-season tires	●		
V Spoke (Style 257) 19 x 9.0 light alloy wheels, and 255/50 run-flat <sup>1</sup> all-season tires		●	○
Streamline (Style 297) 20 x 10.0 front, 20 x 11.0 rear light alloy wheels, and 275/40 front, 315/35 rear run-flat <sup>1</sup> performance tires <sup>2</sup>			●
Star Spoke (Style 212) 19 x 9.0 light alloy wheels, and 255/50 run-flat <sup>1</sup> all-season tires	□/▣		
Star Spoke (Style 258) 19 x 9.0 light alloy wheels, and 255/50 run-flat <sup>1</sup> all-season tires		□/▣	
Y Spoke (Style 214) 20 x 10.0 front, 20 x 11.0 rear light alloy wheels, and 275/40 front, 315/35 rear run-flat <sup>1</sup> performance tires <sup>2</sup> (requires Sport Package or Sport Activity Package; includes increased top-speed limiter)	○		
Star Spoke (Style 259) 20 x 10.0 front, 20 x 11.0 rear light alloy wheels, and 275/40 front, 315/35 rear run-flat <sup>1</sup> performance tires <sup>2</sup> (requires Sport Package or Sport Activity Package ; includes increased top-speed limiter)		○	
Xenon Adaptive Headlights with auto-leveling and Corona headlight-rings	●	●	●
Halogen free-form foglights with Cornering Lights function	●	●	●
Retractable, high-intensity headlight washers	★	★	★
Dual power outside mirrors	●	●	●
Intermittent rain-sensing windshield wipers with adjustable and vehicle-speed-sensitive wiping interval, single-wipe control, windshield-washer system with heated washer jets	●	●	●
Metallic paint	●	●	●
Body-color exterior door handles	●	●	●
Chrome exhaust tips (dual rectangular shape on X6 xDrive50i and ActiveHybrid X6)	●	●	●
Matte-black finish on side-window frame and door-sill trim	●		
Chrome finish on side-window frame and door-sill trim		●	●
High-gloss shadowline trim	□/▣	□/▣	
Running boards	○	○	●
Space-saver spare wheel and tire	○	○	

Audio system	X6 xDrive35i	X6 xDrive50i	ActiveHybrid X6
Anti-theft AM/FM stereo CD radio with Radio Data System (RDS), MP3 capabilities, and 3-channel FM diversity antenna system	●	●	●
High-fidelity 10-speaker sound system includes 2 subwoofers under the front seats and digital 7-channel amplifier with 205 watts of power	●	●	
Premium high-fidelity 16-speaker sound system with Digital Sound Processing (DSP), 2 subwoofers under the front seats and digital 9-channel amplifier with 600 watts of power	△	△	●
Enhanced Premium high-fidelity 16-speaker sound system with 825 watts of power and DIRAC Live technology, including adjustments for sound, stereo or spatial sound (Dolby® Pro Logic II and multichannel 5.1) and 7-band equalizer via iDrive			○
6-disc DVD changer with MP3 capabilities	△	△	●
SIRIUS Satellite Radio with one-year subscription (for additional information, please visit your authorized BMW SAV® center)	○	○	○
Rear-seat entertainment	○	○	○
HD Radio™ with   multicast   FM station reception	●	●	●
Smartphone Integration (requires Premium Package or BMW Assist™ and Premium Sound Package in X6 xDrive35i and X6 xDrive50i)	○	○	○
iPod® and USB adapter (includes cable connector)	△	△	●

اپراد خودرو فارما

تلفون: ۰۲۱-۸۸۸۶۲۰۸۵

FarmaSOS.com

Interior	X6 xDrive35i	X6 xDrive50i	ActiveHybrid X6
10-way power-adjustable driver's and passenger's seat and memory system for driver's seat, steering wheel and outside mirrors	●		
20-way power multi-contour front seats † include standard 10-way power seat functions, plus additional power adjustment functions for shoulder and thigh support, backrest width and lumbar support (contour and position), 2-way manual lateral adjustment for Comfort headrest, and 2-driver memory system	○/□/■/◆ <sup>3</sup>	●	●
10-way power-adjustable front sport seats with 2-way manual thigh support adjustment, and memory system for driver's seat, steering wheel and outside mirrors (no-cost option in X6 xDrive50i with Sport Package or Sport Activity Package)	○/□/■	○	
4-way adjustable power lumbar support for front seats	◇	●	●
Active seat for driver <sup>3</sup>	◆	◆	◆
Front ventilated seats <sup>3</sup>	◆	◆	◆
3-stage heated front seats	○/★	○/★	●
Front-seat center console with armrest, storage compartment, and auxiliary input	●	●	●
Heated rear seats	★	★	★
Rear-seat center armrest	●	●	●
Split-folding rear seats	●	●	●
Nevada Leather upholstery (covers all seating surfaces, headrests, door armrests, front center console armrest)	●	●	●
Perforated Nevada Leather upholstery (no-cost option; requires and must be ordered with Active Ventilated Seat Package)	○	○	○
Nappa Leather upholstery, dashboard, center console and upper door panel (requires multi-contour front seats)	○	○	●
Nappa Leather upholstery, dashboard and upper door panel	○	○	○
Alcantara/Leather combination upholstery (no-cost option; requires optional sport seats)	○	○	○
Brushed Aluminum interior trim (no-cost option)	○	○	○
Dark Bamboo Wood interior trim (no-cost option)	○	○	○
Ash Grain Wood interior trim	●	●	●
Anthracite headliner	□/■	□/■	●
Ambiance lighting package	◇	◇	●
Storage package † includes 2 lashing rails, 4 sliding lashing eyes, and lighting in the cargo area	◇	◇	●
Fully finished cargo area	●	●	●
Retractable cargo cover	●	●	●

- Standard
- Optional
- Included in Sport Package
- Included in Sport Activity Package
- Included in Technology Package
- ◇ Included in Premium Package
- ◆ Included in Active Ventilated Seat Package
- ▲ Included in Rear Climate Package
- ★ Included in Cold Weather Package

<sup>3</sup> Requires Cold Weather Package or heated front seats, and Perforated Nevada Leather.

Comfort and convenience	X6 xDrive35i	X6 xDrive50i	ActiveHybrid X6
Engine Start/Stop button	●	●	●
Vehicle & Key Memory	●	●	●
2-way power glass moonroof with † one-touch‡ operation, sliding interior sunshade, and wind deflector	●	●	●
Power windows with key-off operation, † one-touch‡ opening and closing of all door windows, and anti-trapping feature	●	●	●
Automatic front climate control with separate left/right temperature settings, automatic air conditioning, and recirculation control	●	●	●
4-zone climate control with 4 individual temperature settings	▲	▲	●
Active-charcoal micro-filter ventilation	●	●	●
Heated steering wheel	★	★	★
Comfort Access keyless entry	○	○	●
Power tailgate	●	●	●
Soft-close automatic door operation	○	○	●
Park Distance Control (front and rear)	●	●	●
Dual cupholders front and rear	●	●	●
Dual front sun visors with illuminated mirrors	●	●	●
Automatic tilt-down of right outside mirror for visibility of curb when backing up	●	●	●
Automatic-dimming rear-view mirror with digital-readout compass and automatic-dimming, power-folding side-view mirrors	◇	◇	●
Automatic headlight on/off control	●	●	●
Automatic high beams (requires Premium Package in X6 xDrive35i and X6 xDrive50i)	○	○	○
Privacy glass in rear windows	▲	▲	●
Rear manual side-window sunshades	▲	▲	○
Trailer hitch prewiring	●	●	●
Ski bag	★	★	★

Instrumentation and controls	X6 xDrive35i	X6 xDrive50i	ActiveHybrid X6
3-spoke leather-wrapped multi-function sport steering wheel with paddle shifters	●	●	●
Dynamic Cruise Control	●	●	●
Service Interval Indicator and Check Control vehicle monitor	●	●	●
Electronic analog instrumentation with LED illumination	●	●	●
Outside-temperature display	●	●	●
Tire Pressure Monitor	●	●	●
iDrive system with on-board computer and Controller, and 6 programmable memory buttons	●	●	●
Navigation system with Voice command and Real Time Traffic Information	○/■	●	●
Time-delay courtesy lights † automatically activate when driver's door handle is lifted, remote control is used, or engine is turned off	●	●	●
Head-up Display (HUD) (X6 xDrive35i requires optional Navigation system or Technology Package)	○	○	●
Rear-view camera with Top View	■	○	●
Rear-window defroster	●	●	●
Integrated 3-button Universal garage-door opener	◇	◇	●



Safety and security	X6 xDrive35i	X6 xDrive50i	ActiveHybrid X6
Driver's and passenger's front airbag supplemental restraint system (SRS) with advanced technology: dual-threshold, dual-stage deployment; and front-passenger seat sensors designed to prevent unnecessary airbag deployment	●	●	●
3-point safety belts and head restraints at all seating positions	●	●	●
Front safety belts with automatic pretensioners	●	●	●
Active Head Restraints in front seats	●	●	●
Front- and rear-compartment Head Protection System (HPS) with front side-impact airbags	●	●	●
Rollover sensor that triggers airbags and safety-belt pretensioners in the event of a rollover	●	●	●
Adaptive Brake Lights	●	●	●
Battery Safety Terminal and automatic fuel cut-off, triggered by airbag deployment	●	●	●
Central locking system and Coded Driveaway Protection	●	●	●
Anti-theft alarm system with keyhead remote operation interior motion detector	●	●	●
BMW Assist™ with Bluetooth® wireless technology for hands-free calling (with Bluetooth enabled mobile phone), with phonebook downloading and speech recognition capabilities (please visit your authorized BMW SAV® center for details on standard and optional services and a list of BMW-approved Bluetooth technology enabled mobile phones)	○◇	○◇	●

BMW Services	X6 xDrive35i	X6 xDrive50i	ActiveHybrid X6
BMW Ultimate Service™ (for complete details on BMW Ultimate Service, visit <a href="http://bmwusa.com/ultimateservice">bmwusa.com/ultimateservice</a> )	●	●	●

Active Ventilated Seat Package <sup>4</sup>	X6 xDrive35i	X6 xDrive50i	ActiveHybrid X6
20-way power multi-contour front seats † include standard 10-way power seat functions, plus additional power adjustment functions for shoulder and thigh support, backrest width and lumbar support (contour and position), 2-way manual lateral adjustment for Comfort headrest, and 2-driver memory system	◆	●	●
Active seat for driver	◆	◆	◆
Front ventilated seats	◆	◆	◆

Cold Weather Package	X6 xDrive35i	X6 xDrive50i	ActiveHybrid X6
Retractable, high-intensity headlight washers	★	★	★
3-stage heated front seats	○★	○★	●
Heated steering wheel	★	★	★
Ski bag	★	★	★
Heated rear seats	★	★	★

- Standard
- Optional
- Included in Sport Package
- ▣ Included in Sport Activity Package
- Included in Technology Package
- ◇ Included in Premium Package
- ◆ Included in Active Ventilated Seat Package
- ▲ Included in Rear Climate Package
- ★ Included in Cold Weather Package

<sup>4</sup> Requires Cold Weather Package or heated front seats, and Perforated Nevada Leather.  
<sup>5</sup> Run-flat tires do not come equipped with a spare tire and wheel. However, a spare tire and wheel can be ordered as an option in X6 xDrive35i and X6 xDrive50i.  
<sup>6</sup> Requires Sport Package or Sport Activity Package; includes increased top-speed limiter. Due to low-profile tires, please note: wheels, tires, and suspension parts are more susceptible to road hazard and consequential damage. Performance tires not recommended for driving in snow and ice conditions.

Premium Package	X6 xDrive35i	X6 xDrive50i	ActiveHybrid X6
4-way adjustable power lumbar support for front seats	◇	●	●
Ambiance lighting package	◇	◇	●
Storage package † includes 2 lashing rails, 4 sliding lashing eyes, and lighting in the cargo area	◇	◇	●
Automatic-dimming rear-view mirror with digital-readout compass and automatic-dimming, power-folding side-view mirrors	◇	◇	●
Integrated 3-button Universal garage-door opener	◇	◇	●
BMW Assist with Bluetooth wireless technology for hands-free calling (with Bluetooth enabled mobile phone), with phonebook downloading and speech recognition capabilities (please visit your authorized BMW SAV center for details on standard and optional services and a list of BMW-approved Bluetooth technology enabled mobile phones)	○◇	○◇	●

Rear Climate Package	X6 xDrive35i	X6 xDrive50i	ActiveHybrid X6
4-zone climate control with 4 individual temperature settings	▲	▲	●
Privacy glass in rear windows	▲	▲	●
Rear manual side-window sunshades	▲	▲	○

Sport Package/Sport Activity Package	X6 xDrive35i	X6 xDrive50i	ActiveHybrid X6
Adaptive Drive† includes Active Roll Stabilization and Electronic Damping Control (not included in Sport Activity Package)	□	□	●
Star Spoke® (Style 212) 19 x 9.0 light alloy wheels, and 255/50 run-flat <sup>5</sup> all-season tires	□/▣	□/▣	●
Star Spoke (Style 258) 19 x 9.0 light alloy wheels, and 255/50 run-flat <sup>5</sup> all-season tires	□/▣	□/▣	●
Y Spoke (Style 214) 20 x 10.0 front, 20 x 11.0 rear light alloy wheels, and 275/40 front, 315/35 rear run-flat <sup>5</sup> performance tires <sup>6</sup>	○	○	●
Star Spoke (Style 259) 20 x 10.0 front, 20 x 11.0 rear light alloy wheels, and 275/40 front, 315/35 rear run-flat <sup>5</sup> performance tires <sup>6</sup>	○	○	●
High-gloss shadowline trim	□/▣	□/▣	●
20-way power multi-contour front seats † include standard 10-way power seat functions, plus additional power adjustment functions for shoulder and thigh support, backrest width and lumbar support (contour and position), 2-way manual lateral adjustment for Comfort headrest, and 2-driver memory system	○/◆ <sup>4</sup>	●	●
10-way power-adjustable front sport seats with 2-way manual thigh support adjustment, and memory system for driver's seat, steering wheel and outside mirrors (no-cost option in X6 xDrive50i with Sport Package or Sport Activity Package)	□/▣	○	●
Anthracite headliner	□/▣	□/▣	●
Performance upgrade (requires Sport Package or Sport Activity Package)	○	○	●

Technology Package	X6 xDrive35i	X6 xDrive50i	ActiveHybrid X6
Navigation system with Voice command, Real Time Traffic Information and Online Information Services	○/■	●	●
Rear-view camera with Top View	■	○	●

Premium Sound Package	X6 xDrive35i	X6 xDrive50i	ActiveHybrid X6
Premium high-fidelity 16-speaker sound system with Digital Sound Processing (DSP), 2 subwoofers under the front seats and digital 9-channel amplifier with 600 watts of power	△	△	●
6-disc DVD changer with MP3 capabilities	△	△	●
iPod® and USB adapter (includes cable connector)	△	△	●

Stand-alone optional equipment	X6 xDrive35i	X6 xDrive50i	ActiveHybrid X6
Active Steering with Servotronic power assist (requires Sport Package)	○	○	
Y Spoke (Style 214) 20 x 10.0 front, 20 x 11.0 rear light alloy wheels, and 275/40 front, 315/35 rear run-flat <sup>7</sup> performance tires <sup>8</sup> (requires Sport Package or Sport Activity Package; includes increased top-speed limiter)	○		
Star Spoke (Style 259) 20 x 10.0 front, 20 x 11.0 rear light alloy wheels, and 275/40 front, 315/35 rear run-flat <sup>7</sup> performance tires <sup>8</sup> (requires Sport Package or Sport Activity Package; includes increased top-speed limiter)		○	
V Spoke (Style 257) 19 x 9.0 light alloy wheels, and 255/50 run-flat <sup>7</sup> all-season tires		●	○
Performance upgrade (requires Sport Package or Sport Activity Package)	○	○	
Running boards	○	○	●
Space-saver spare wheel and tire	○	○	
20-way power multi-contour front seats <sup>□</sup> include standard 10-way power seat functions, plus additional power adjustment functions for shoulder and thigh support, backrest width and lumbar support (contour and position), 2-way manual lateral adjustment for Comfort headrest, and 2-driver memory system	○/□/◆ <sup>9</sup>	●	●
10-way power-adjustable front sport seats with 2-way manual thigh support adjustment, and memory system for driver's seat, steering wheel and outside mirrors (no-cost option in X6 xDrive50i with Sport Package or Sport Activity Package)	○/□/■	○	
3-stage heated front seats	○/★	○/★	●
Perforated Nevada Leather upholstery (no-cost option; requires and must be ordered with Active Ventilated Seat Package)	○	○	○
Nappa Leather upholstery, dashboard and center console (requires multi-contour front seats)	○	○	●
Alcantara/Leather combination upholstery (no-cost option; requires optional sport seats)	○	○	○
Brushed Aluminum interior trim (no-cost option)	○	○	○
Dark Bamboo Wood interior trim (no-cost option)	○	○	○
Comfort Access keyless entry	○	○	●
Soft-close automatic door operation	○	○	●
SIRIUS Satellite Radio with one-year subscription (for additional information, please visit your authorized BMW SAV® center)	○	○	○
Rear-seat entertainment	○	○	○
Smartphone Integration (requires Premium Package or BMW Assist,™ and Premium Sound Package in X6 xDrive35i and X6 xDrive50i)	○	○	○
Automatic high beams (requires Premium Package in X6 xDrive35i and X6 xDrive50i)	○	○	○
Navigation system with Voice command, Real Time Traffic Information and Online Information Services	○/■	●	●
Head-up Display (HUD) (X6 xDrive35i requires optional Navigation system or Technology Package)	○	○	●
Rear-view camera with Top View	■	○	●
BMW Assist with Bluetooth® wireless technology for hands-free calling (with Bluetooth enabled mobile phone)	○/◇	○/◇	●

- Standard
  - Optional
  - △ Included in Premium Sound Package
  - Included in Sport Package
  - Included in Sport Activity Package
  - ◇ Included in Premium Package
  - ◆ Included in Active Ventilated Seat Package
  - ★ Included in Cold Weather Package
  - Included in Technology Package
- <sup>7</sup> Run-flat tires do not come equipped with a spare tire and wheel. However, a spare tire and wheel can be ordered as an option in X6 xDrive35i and X6 xDrive50i.
- <sup>8</sup> Requires Sport Package; includes increased top-speed limiter. Due to low-profile tires, please note: wheels, tires, and suspension parts are more susceptible to road hazard and consequential damage. Performance tires not recommended for driving in snow and ice conditions.
- <sup>9</sup> Requires Cold Weather Package or optional heated front seats, and Perforated Nevada Leather.

Weight		X6 xDrive35i	X6 xDrive50i	ActiveHybrid X6
Unladen weight	lbs	4894	5269	5765
Weight distribution, front/rear	%	49.5/50.5	51.9/48.1	51.1/48.9

Engine		X6 xDrive35i	X6 xDrive50i	ActiveHybrid X6
Liters/type		3.0-liter turbocharged inline 6	4.4-liter turbocharged V-8	4.4-liter turbocharged V-8
Bore/stroke	inch	3.31/3.53	3.50/3.48	3.50/3.48
Nominal output/rpm	hp	300/5800 (320/5800-6000)	400/5500-6400 (440/5500-6000)	400/5500-6400
Maximum torque/rpm	lb-ft	300/1400-5000 (330/1600)	450/1750-4500 (480/2000)	450/1750-4500

Transmission		X6 xDrive35i	X6 xDrive50i	ActiveHybrid X6
Automatic gear ratios	I/II/III	:1	4.17/2.34/1.52	4.17/2.34/1.52
	IV/V/VI/VII/R	:1	1.14/0.87/0.69/□ /3.40	1.14/0.87/0.69/□ /3.40
Final drive ratio		:1	3.91	3.64

Performance		X6 xDrive35i	X6 xDrive50i	ActiveHybrid X6
Drag coefficient	C <sub>d</sub>	0.35	0.37	0.36
Top speed <sup>1</sup>	mph	130 [150]	129 [156]	130
Acceleration 0-60 mph <sup>2</sup>	sec	6.5 (6.3)	5.3 (5.1)	5.4

Fuel consumption <sup>3</sup>		X6 xDrive35i	X6 xDrive50i	ActiveHybrid X6
City / highway	mpg	15/20	12/18	TBD
Approx. tank capacity	gal	22.5	22.5	TBD

Tires, wheels and brakes		X6 xDrive35i	X6 xDrive50i	ActiveHybrid X6
Tire dimensions and type	standard	255/50 run-flat all-season	255/50 run-flat all-season	275/40 front, 315/35 rear run-flat performance
Wheel dimensions/material	standard	19 x 9.0/light alloy	19 x 9.0/light alloy	20 x 10.0 front, 20 x 11.0 rear/light alloy
Brakes, front/rear	inch	13.7/13.6	14.4/13.6	15.1/13.6

Figures in ( ) refer to optional Performance upgrade; requires Sport Package or Sport Activity Package. All-season tires limited to 130 mph. Figures in [ ] refer to Sport Package with optional 20" wheels and performance tires.

<sup>1</sup> Top speed limited electronically.  
<sup>2</sup> BMW AG test results. Actual acceleration results may vary, depending on specification of vehicle; road and environmental conditions; testing procedures and driving style. These results should be used for comparison only and verification should not be attempted on public roads. BMW urges you to obey all posted speed laws and always wear safety belts.  
<sup>3</sup> EPA-estimated figures are for comparison purposes only. Your actual mileage will vary, depending on speed, driving habits, trip length and driving conditions; actual mileage may be lower.



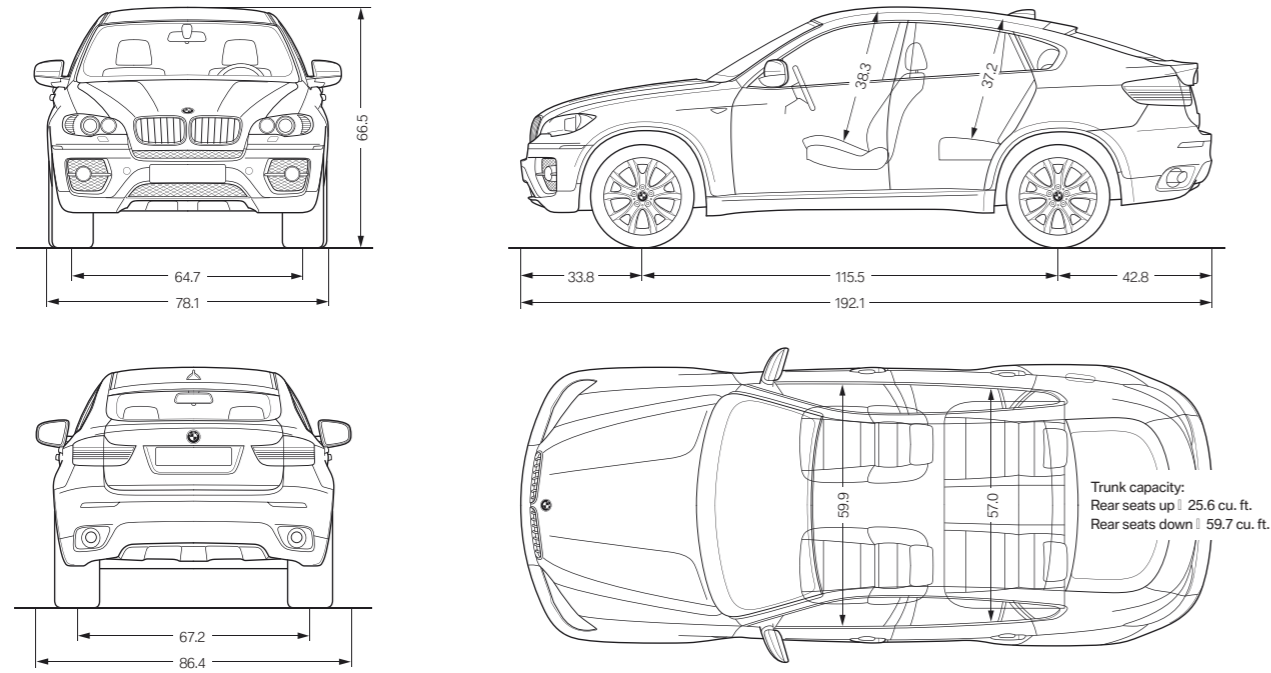

All dimensions of the technical drawings in inches. Height indicated with roof antenna and unloaded.

**BMW Recycling.**

BMW is a strong proponent of the environment and social responsibility. It is important to manage the earth's resources responsibly, and not jeopardize the needs of future generations. That is why BMW makes vehicles that minimize adverse environmental impact, from production (pollution prevention and waste minimization at the plant) through owner use (low emissions) to eventual disposal (easy drainability of all fluid-related components and easy neutralization of all pyrotechnic devices).

This effort has been recognized worldwide and, as a result, we are pleased to have received numerous environmental honors. In the U.S., for example, the Environmental Protection Agency accepted BMW's Spartanburg, SC production and manufacturing facility as a charter member of the agency's National Environmental Performance Track. Internationally, BMW AG is the parent company of both BMW of North America and BMW Manufacturing Co., Spartanburg, SC. BMW was the first automotive company to be represented on the Dow Jones Sustainability Group Index, and has remained on the Index ever since. At BMW, we strive for high performance in everything we do.

U.S. Distributor: BMW of North America, LLC, Woodcliff Lake, NJ 07677. All illustrations and specifications contained in this brochure are based on the latest product information available at the time of printing. BMW reserves the right to make changes at any time, without notice, in colors, materials, equipment, specifications and models. BMW may, subject to legal requirements, determine the Model Year designation of its vehicles. The Model Year designation on any particular model may be longer or shorter than 12 months. Some vehicles pictured may contain non-U.S. equipment. Some models may be shown with optional equipment. While BMW NA makes all reasonable efforts to provide accurate information in this brochure, there is no guarantee or warranty of accuracy. Furthermore, we do not assume any liability for the accuracy or completeness of information presented. This brochure shall not be used or relied upon as a substitute for information that is available from your BMW SAV® center. Further information can be obtained from your authorized BMW SAV center or [bmwusa.com](http://bmwusa.com).

©2009 BMW of North America, LLC. Not to be reproduced wholly or in part without written permission of BMW NA. The BMW name, logo, model names and SAV are registered trademarks. The Bluetooth word mark and logos are owned by the Bluetooth SIG, Inc. and any use of such marks by BMW is under license. iPod is a registered trademark of Apple Inc. Other trademarks and trade names are the property of their respective owners.

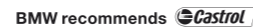

Equipped with the best ideas.  
Original BMW Accessories.



Add the convenience of a rear-deck bicycle holder, and the bold gleam of 21" Star Spoke (Style 128) chrome wheels

Driving a BMW is always a special experience and it can be enhanced even further with Original BMW Accessories. Benefit from innovative solutions that combine unique ideas, stunning design and smart functionality. Discover a wide range of Original BMW Accessories that customize, enhance and protect your X6's exterior, interior, technology and transporters. From load carriers to cargo

mats, sheepskin seat covers and more, every Original BMW Accessory adheres to BMW's highest quality standards. Each is designed to fit the X6 perfectly and last just as long. For additional information on BMW Accessories, please see your authorized BMW SAV® center or visit online at [accessories.bmwusa.com](http://accessories.bmwusa.com).



Rear entertainment system with 7" tilt-adjustable color screens.



Snap-in-adaptor for iPhone™ lets you control music and make hands-free calls through the steering wheel or iDrive.



Non-slip dual-sided cargo mat tailored to fit the X6 helps keep the cargo area carpet clean.

امداد خودرو فارما  
تلفون: ۰۲۱-۸۸۸۶۲۰۸۵  
FarmaSOS.com

## BMW European Delivery: Save money ☺ and drive your new BMW on the roads it was designed for.

The new **BMW Welt** ( BMW World ) delivery and brand-experience center in Munich is bold proof of BMW's passion for design. When you take advantage of the BMW European Delivery Program,<sup>1</sup> this is where you will meet your new BMW ☺ in a personalized process that is highly dramatic and totally unforgettable. (You might also realize substantial savings that just may pay for your trip.) While you're there, marvel at the historic BMWs in the Museum; learn about our engineers' newest innovations in the Technology and Design Atelier; and take a tour of the plant to experience firsthand the state-of-the-art methods used to create a BMW. Then comes the unique experience of driving your new BMW on the roads it was designed for. To learn more, visit [bmwusa.com/europeandelivery](http://bmwusa.com/europeandelivery).

### BMW Ultimate Service.™

At BMW, we believe that a premium ownership experience should feature performance and luxury, as well as safety and convenience. We believe you should be able to drive a BMW to its potential, while enjoying peace of mind and reduced cost of ownership. That's the idea behind BMW Ultimate Service: a suite of comprehensive programs and services that are included in every 2009 and later model year vehicle. The New Vehicle Limited Warranty, the BMW Maintenance Program, and Roadside Assistance come standard, with BMW Assist™ offered as an option. BMW Ultimate Service starts with the **New Vehicle Limited Warranty**, providing you with coverage for the first four years or 50,000 miles, whichever comes first. Additionally, you have 12-year, unlimited-mileage warranty protection against corrosion and rust perforation.<sup>2</sup> **BMW Maintenance Program** is one of the most comprehensive maintenance programs in its class. We cover all factory-recommended maintenance during the New Vehicle Limited Warranty coverage period. This includes scheduled oil services and inspections. Also covered is the replacement of items that are subject to normal wear and tear, such as brake pads, wiper blade inserts and engine drive belts.<sup>3</sup> And, thanks to BMW's advanced engineering, most owners enjoy a well-balanced maintenance schedule, with flexible routine service intervals that can save you time. When your vehicle requires attention, your authorized BMW or BMW SAV® center ensures that it receives only genuine BMW parts ☺ your assurance of exacting quality standards.

**BMW Roadside Assistance** is provided free of charge for the first four years ☺ with no mileage limit. Call **1-800-332-4BMW (4269)** for friendly on-the-road help, 24/7, anywhere in the United States, Canada and Puerto Rico. This includes everything from flat-tire changes, emergency gasoline and lock-out service, to towing, alternative transportation and even trip-interruption benefits. This service also provides valuable trip-routing advice.

The **BMW Assist™** Safety Plan<sup>4</sup> is an optional four-year program. You'll enjoy peace of mind knowing that a friendly response specialist is there to help you, 24/7, at just the push of a button. The Safety Plan includes Automatic Collision Notification, Emergency Request, Enhanced Roadside Assistance, Door Unlock, Stolen Vehicle Recovery and Customer Relations. MyInfo allows you to send business locations and street addresses with their associated phone numbers from the Google Maps™ website directly to your BMW. The destination can be sent to your Navigation system for turn-by-turn directions, and you can call the destination via your Bluetooth® linked cell phone. And for the ultimate in coverage, add the optional **Convenience Plan.**<sup>5</sup> You'll enjoy unlimited access to personalized Directions, Traffic and Weather reports, as well as our Concierge feature, which can send a destination address and phone number, such as a restaurant or hotel, right to your BMW. You can make up to four operator-assisted calls per year with Critical Calling if your cell phone is not available, or if its battery is discharged. BMW Search™ allows online access to up-to-date fuel prices and the latest weather forecasts, as well as Bloomberg's stock indices and the powerful reach of the Google Maps™ database ☺ delivered to the iDrive display right inside your vehicle.

BMW's unique **TeleService**, included in the BMW Assist Safety Plan, continually monitors specific parts that are subject to wear and tear ☺ including the engine oil, micro-filter, spark plugs, brake linings and various fluids ☺ as well as services that require attention at regular intervals, such as vehicle service inspections. This data is automatically transmitted to your BMW center, which will then call you to schedule a service appointment. You don't have to keep track of when your vehicle requires routine maintenance. An added benefit: any needed maintenance service parts will already be on hand, so your BMW is serviced and returned to you as quickly as possible.

For more details on BMW Ultimate Service, visit your preferred BMW or BMW SAV center or log on to [bmwusa.com/ultimateservice](http://bmwusa.com/ultimateservice).

### BMW Virtual Center.

If you get the sudden urge to shop for a BMW but your BMW center is closed, there's good news ☺ the BMW Virtual Center is open 24 hours a day! Log on to [bmwusa.com](http://bmwusa.com), then click on the model series you are interested in. After selecting the BMW that interests you, click on ☺ Build Your Own ☺ Configure the BMW of your dreams, and see what the monthly payments would be. You can even send the specifications to your authorized BMW or BMW SAV® center, apply for financing, or request a test drive ☺ all online!

### BMW Financial Services.

Arranging to buy or lease a BMW is easier than you may think. Your authorized BMW SAV center offers leasing and financing to suit your personal needs through BMW Financial Services.<sup>6</sup> Start the process at our website, where you can build your ☺ dream vehicle,☺ get an estimate on a

monthly lease or financing payment, submit a credit application to BMW Financial Services ☺ and get approval ☺ all online!<sup>6</sup> To find out how BMW Financial Services can help put you behind the wheel of your favorite BMW model, log on to [bmwusa.com/fs](http://bmwusa.com/fs) or call, toll-free, **1-800-578-5000**.

### BMW Publications and Media Gallery.

Sent to new owners and lessees several times a year, **BMW Magazine** is a fascinating view of the latest events and products in the world of BMW, including personality profiles, travel reviews, and the latest BMW technologies. You can read articles from **BMW Magazine**, as well as **Mdriver** and **Inside Track** on the BMW website at [bmwusa.com](http://bmwusa.com) in the Media Gallery/News Feed, found in the Experience section. Here you can also view featured videos and images, read recent news articles, and download BMW wallpapers. For more information, call Customer Assistance at **1-800-334-4BMW (4269)** or visit BMW online at [bmwusa.com](http://bmwusa.com).

<sup>1</sup> Not all models available for BMW European Delivery Program. Please go to [bmwusa.com](http://bmwusa.com) or visit your local authorized BMW or BMW SAV center for details.

<sup>2</sup> See your authorized BMW SAV center for details on these limited warranties.

<sup>3</sup> The BMW Maintenance Program covers factory-recommended maintenance services as determined by the Service Interval Indicator for all new eligible MY 2004 and later BMW vehicles. Specific additional items that need replacement due to normal wear and tear are also covered. The maintenance coverage period is for the first 4 years or 50,000 miles, whichever comes first. Exclusions from coverage include: gasoline, gasoline additives, windshield washer fluid and additives, tires, wheels, wheel alignment and tire balancing. All work must be performed by an authorized BMW SAV center. See the Service and Warranty Information booklet for specific terms, conditions and limitations. Further information can also be obtained from your local authorized BMW SAV center.

<sup>4</sup> The BMW Assist and Bluetooth Hands-free Calling system with 4 years of Safety Plan services is optional or included in the Premium Package. In order to receive BMW Assist services, a subscriber agreement must be completed and transferred to the BMW Assist Response Center. GPS and underlying wireless services must be available and functioning; vehicle ignition must be turned on (except for Door Unlock and Stolen Vehicle recovery), battery charged and connected and vehicle's electrical system operational; services may be limited to certain geographic areas. Call toll-free **1-888-333-6118**, log on to [bmwassist.com](http://bmwassist.com), or visit your BMW SAV center for additional program details. Services are subject to the terms and conditions of your subscriber agreement.

<sup>5</sup> Requires BMW Assist Safety Plan subscription. Services are subject to the terms and conditions of your subscriber agreement. Please go to [bmwassist.com](http://bmwassist.com) for additional details on the optional Convenience Plan.

<sup>6</sup> Subject to credit approval and other terms and conditions.

More about BMW



bmwusa.com  
1-800-334-4BMW

The Ultimate  
Driving Machine®

# امداد خودرو فارما

تلفن شبانه روزی: ۰۲۱-۸۸۸۶۲۰۸۵

FarmaSOS.com