

# Contents

## A-Z

Owner's Manual  
for Vehicle



The Ultimate  
Driving Machine



# THE BMW 4 SERIES CONVERTIBLE.

## OWNER'S MANUAL.

**BMW EfficientDynamics**  
Less emissions. More driving pleasure.

# امداد خودرو فارما

تلفن شبانه روزی: ۰۲۱-۸۸۸۶۲۰۸۵

**FarmaSOS.com**

## 4 Series **Owner's Manual for Vehicle**

Thank you for choosing a BMW.

The more familiar you are with your vehicle, the better control you will have on the road. We therefore strongly suggest:

Read this Owner's Manual before starting off in your new BMW. Also use the Integrated Owner's Manual in your vehicle. It contains important information on vehicle operation that will help you make full use of the technical features available in your BMW. The manual also contains information designed to enhance operating reliability and road safety, and to contribute to maintaining the value of your BMW.

Any updates made after the editorial deadline for the printed or Integrated Owner's Manual are found in the appendix of the printed Quick Reference for the vehicle.

Supplementary information can be found in the additional brochures in the onboard literature.

We wish you a safe and enjoyable ride.

BMW AG

امداد خود راننده فارما

تلفن شبانه روزی: ۰۲۱-۸۸۸۶۲۰۸۵

**FarmaSOS.com**

The Owner's Manual is available in many countries as an app.

For more information, go to

[www.bmw.com/bmw\\_drivers\\_guide](http://www.bmw.com/bmw_drivers_guide)

# امداد خودرو فارما

تلفن شبانه روزی: ۰۲۱-۸۸۸۶۲۰۸۵

[FarmaSOS.com](http://FarmaSOS.com)

© 2014 Bayerische Motoren Werke  
Aktiengesellschaft

Munich, Germany

Reprinting, including excerpts, only with the written  
consent of BMW AG, Munich.

US English X/14, 11 14 490

Printed on environmentally friendly paper, bleached  
without chlorine, suitable for recycling.

# ADDENDUM TO BMW 4 SERIES OWNER'S MANUAL 1402956860

We wanted to provide you with some updates and clarifications with respect to the printed BMW Owner's Manual. These updates and clarifications will supersede the materials contained in that document.

1. Where the terms "service center," "the service center," "your service center," "service specialist," or "service" are used in the Owner's Manual, we wanted to clarify that the terms refer to a BMW dealer's service center or another service center or repair shop that employs trained personnel that can perform maintenance and repair work on your vehicle in accordance with BMW specifications.
2. Where the text of the Owner's Manual contains an affirmative instruction to contact a "service center" or "your service center," we wanted to clarify that BMW recommends that, if you are faced with one of the situations addressed by that text, you contact or seek the assistance of a BMW dealer's service center or another service center or repair shop that employs trained personnel that can perform maintenance and repair work on your vehicle in accordance with BMW specifications.

While BMW of North America LLC, at no cost to you, will pay for repairs required by the limited warranties provided with respect to your

vehicle and for maintenance under the Maintenance Program during the applicable warranty and maintenance coverage periods, you are free to elect, both during those periods and thereafter, to have maintenance and repair work provided by other service centers or repair shops.

3. Where the Owner's Manual makes reference to parts and accessories having been approved by BMW, those references are intended to reflect that those parts and accessories are recommended by BMW of North America LLC. You may elect to use other parts and accessories, but, if you do, we recommend that you make sure that any such parts and/or accessories are appropriate for use on your vehicle.
4. At page 7, under the warranty section's discussion of homologation, where it states that you "cannot lodge warranty claims for your vehicle there," the text should read that you "may not be able to lodge warranty claims for your vehicle there."
5. At page 7, under the "Parts and accessories" section, in the sixth sentence, the word "cannot" should read "does not."
6. At page 56, in the "Check and replace safety belts" section, the

text beginning, "This should only be done by your service center . . ." should be disregarded and the following text should be read in lieu thereof: "BMW recommends having this work performed by a service center as it is important that this safety feature functions properly."

7. At page 90, under the heading: "Special windshield," the paragraph beginning, "Therefore, have the special windshield . . ." should be disregarded and the following text should be read in lieu thereof: "BMW recommends that you have the special windshield replaced by the service center."
8. At page 99, under the heading: "Hints," the sentence beginning, "Only have the airbags checked . . ." should be disregarded and the following language should be read in lieu thereof: "The manufacturer of your vehicle strongly suggests that you have airbags checked, repaired or dismantled and the system scrapped by your service center or an authorized repair shop for handling explosives."
9. At page 99, in the "Triggered rollover protection system" section, the sentence beginning, "Have this work performed only by your service center . . ." should be disregarded and the following text should be read in lieu thereof: "BMW recommends having this work performed by a service center as it is important that this safety feature functions properly."
10. At page 169 under the heading: "Objects within the range of movement of the pedals" and at page 223 under the heading: "Carpets and floor mats," the paragraph that begins: "Only use floor mats . . ." should be disregarded and the following language should be read in lieu thereof: "The manufacturer of your vehicle recommends that you use floor mats that have been identified by it as appropriate for use in your vehicle and that can be properly fixed in place."
11. At page 188, under the heading "Tire inflation pressure specifications," the sentence beginning, "Tire inflation pressure specifications apply to approved tire sizes . . ." should be disregarded.
12. At page 195, under the heading: "Mounting," the paragraph beginning, "Have mounting and balancing . . ." should be disregarded and the following text should be read in lieu thereof: "BMW recommends that you have mounting and balancing performed by your service center or a tire mounting specialist."
13. At page 195, under the heading: "Approved wheels and tires," the term "Approved" should be disregarded and in lieu thereof, the term "Recommended" should be read in its place. In addition, the text of that section should be disregarded and the following text should be read in lieu thereof:

The manufacturer of your vehicle strongly suggests that you use wheels and tires that have been recommended by the vehicle manufacturer for your vehicle type; otherwise, for example, despite having the same official size ratings, variations can lead to body contact and with it, the risk of severe accidents.

The manufacturer of your vehicle does not evaluate non-recommended wheels and tires to determine if they are suitable for use on your vehicle.

14. At page 196 and 197, under the heading: "Fine-link snow chains," the text should be disregarded and the following text should be read in lieu thereof:

Only certain types of fine-link snow chains have been tested by the manufacturer of your vehicle and are determined by the manufacturer of your vehicle to be road safe and are recommended by the manufacturer of your vehicle.

Information about recommended snow chains is available from a service center.

15. At page 199, under the heading "Hood," the sentence beginning, "If you are unfamiliar" should be disregarded.
16. At page 202, under the heading: "Approved oil types," the references to "Approved" should be read as "Suitable." Where it reads: You

can add oils with the following specifications," that text should be disregarded, and the following text read in lieu thereof: "Add engine oils that meet the following oil rating standards: . . ."

17. At page 202, under the heading: "Alternative oil types," the text preceding the chart should be disregarded, and in lieu thereof should be read as follows: "If an engine oil suitable for continuous use is not available, up to 1 US quart/liter of an engine oil with the following oil rating can be added: . . ." The reference to "specification" should be read as "rating."
18. At page 202, under the heading: "Engine oil change," the text should be disregarded and in lieu thereof should be read as follows:

BMW recommends that you have the oil changed at your BMW dealer's service center or at another service center that has trained personnel that can perform the work in accordance with BMW specifications.

19. At page 204, under the heading: "Service and Warranty Information Booklet for US models and Warranty and Service Guide Booklet for Canadian models," the second paragraph should be disregarded and the following text read in lieu thereof:

The manufacturer of your vehicle recommends that you have maintenance and repair performed

by your BMW dealer's service center or another service center or repair shop that employs trained personnel that can perform maintenance and repair work on your vehicle in accordance with BMW specifications. The manufacturer of your vehicle recommends that you maintain records of all maintenance and repair work performed on your vehicle.

After a battery replacement, the manufacturer of your vehicle recommends that you have the battery registered on your vehicle by a service center to ensure that all comfort functions are fully available, and that any "check control" messages of these comfort functions are no longer displayed.

20. At page 207, where it reads: "Do not perform work/bulb replacement on xenon headlights," that text should be disregarded and in lieu thereof the following text should be read: "Xenon headlamp work or replacement can cause serious and fatal injuries." In the text that follows, where it reads: "[h]ave any work on the xenon lighting system . . .," the following words should be read as preceding that passage: "It is strongly suggested that you . . ."

21. At page 212, under the "Battery replacement" section, the text should be disregarded and in lieu thereof the following text should be read:

Use of recommended vehicle batteries

The manufacturer of your vehicle recommends that you use vehicle batteries that it has tested and recommends for use in your vehicle; otherwise the vehicle could be damaged and systems or functions may not be fully available.



# Contents

The fastest way to find information on a particular topic or item is by using the index, refer to page 230.

6 Notes

## At a glance

14 Cockpit

18 iDrive

26 Voice activation system

29 Integrated Owner's Manual in the vehicle

## Controls

34 Opening and closing

52 Adjusting

61 Transporting children safely

64 Driving

76 Displays

91 Lights

96 Safety

119 Driving stability control systems

124 Driving comfort

145 Climate control

153 Interior equipment

163 Storage compartments

## Driving tips

168 Things to remember when driving

171 Loading

174 Saving fuel

## Mobility

184 Refueling

186 Fuel

188 Wheels and tires

198 Engine compartment

200 Engine oil

203 Coolant

204 Maintenance

206 Replacing components

215 Breakdown assistance

220 Care

## Reference

226 Technical data

230 Everything from A to Z

تلفن شبانه روزی: ۰۲۱-۸۸۸۶۲۰۸۵

FarmaSOS.com

# Notes

## Using this Owner's Manual

### Orientation

The fastest way to find information on a particular topic is by using the index.

An initial overview of the vehicle is provided in the first chapter.

### Updates made after the editorial deadline

Any updates made after the editorial deadline for the Owner's Manuals are found in the appendix of the printed Quick Reference for the vehicle.

### User's manual for Navigation, Entertainment, Communication

The topics of Navigation, Entertainment, Communication and the short commands of the voice activation system are described in a separate user's manual, which is also included with the onboard literature.

## Symbols

 Indicates precautions that must be followed precisely in order to avoid the possibility of personal injury and serious damage to the vehicle.

◀ Marks the end of a specific item of information.

 Refers to measures that can be taken to help protect the environment.

"..." Identifies display texts in vehicle used to select individual functions.

»...« Verbal instructions to use with the voice activation system.

»...« Identifies the answers generated by the voice activation system.

## Symbols on vehicle components

 Indicates that you should consult the relevant section of this Owner's Manual for information on a particular part or assembly.

## Vehicle features and options

This Owner's Manual describes all models and all standard, country-specific and optional equipment that is offered in the model series. Therefore, in this Owner's Manual, we also describe and illustrate features that are not available in your vehicle, e.g., because of the selected optional features or the country-specific version.

This also applies to safety-related functions and systems.

For any options and equipment not described in this Owner's Handbook, refer to the Supplementary Owner's Handbooks.

On right-hand drive vehicles, some controls are arranged differently from what is shown in the illustrations.

## Status of the Owner's Manual

### Basic information

The manufacturer of your vehicle pursues a policy of constant development that is conceived to ensure that our vehicles continue to embody the highest quality and safety standards. In rare cases, therefore, the features described in this Owner's Manual may differ from those in your vehicle.

## Updates made after the editorial deadline

Any updates made after the editorial deadline for the Owner's Manuals are found in the appendix of the printed Quick Reference for the vehicle.

## For your own safety

### Warranty

Your vehicle is technically configured for the operating conditions and registration requirements applying in the country of first delivery - homologation. If your vehicle is to be operated in a different country it might be necessary to adapt your vehicle to potentially differing operating conditions and permit requirements. If your vehicle does not comply with the homologation requirements in a certain country you cannot lodge warranty claims for your vehicle there. Further information can be obtained from your Service Centre.

### Maintenance and repairs

Advanced technology, e.g., the use of modern materials and high-performance electronics, requires suitable maintenance and repair work.

Therefore, have this work performed only by a BMW center or a workshop that works according to BMW repair procedures with appropriately trained personnel.

If work is not carried out properly, there is a danger of subsequent damage and related safety hazards.

## Parts and accessories

BMW recommends using parts and accessories approved by BMW for this purpose.

Your BMW center is the right contact for genuine BMW parts and accessories, other products approved by BMW and related qualified advice.

BMW has tested these products for safety and suitability in relation to BMW vehicles.

BMW can assume responsibility for them. However, we cannot assume any responsibility whatsoever for parts and accessories that have not been specifically approved by BMW.

BMW cannot evaluate whether each individual product from another manufacturer can be used with BMW vehicles without presenting a safety hazard. This guarantee is also not applicable when country-specific government approval has been granted. Testing of this kind may fail to embrace the entire range of potential operating conditions to which components might be exposed on BMW vehicles. Such products could conceivably fail to comply with BMW's own stringent quality standards.

### California Proposition 65 Warning

California laws require us to state the following warning:

Engine exhaust and a wide variety of automobile components and parts, including components found in the interior furnishings in a vehicle, contain or emit chemicals known to the State of California to cause cancer and birth defects and reproductive harm. In addition, certain fluids contained in vehicles and certain products of component wear contain or emit chemicals known to the State of California to cause cancer and birth defects or other reproductive harm. Battery posts, terminals and related accessories contain lead and lead com-

pounds. Wash your hands after handling. Used engine oil contains chemicals that have caused cancer in laboratory animals. Always protect your skin by washing thoroughly with soap and water.

## Service and warranty

We recommend that you read this publication thoroughly. Your vehicle is covered by the following warranties:

- ▷ New Vehicle Limited Warranty.
- ▷ Rust Perforation Limited Warranty.
- ▷ Federal Emissions System Defect Warranty.
- ▷ Federal Emissions Performance Warranty.
- ▷ California Emission Control System Limited Warranty.

Detailed information about these warranties is listed in the Service and Warranty Information Booklet for US models or in the Warranty and Service Guide Booklet for Canadian models.

Your vehicle has been specifically adapted and designed to meet the particular operating conditions and homologation requirements in your country and continental region in order to deliver the full driving pleasure while the vehicle is operated under those conditions. If you wish to operate your vehicle in another country or region, you may be required to adapt your vehicle to meet different prevailing operating conditions and homologation requirements. You should also be aware of any applicable warranty limitations or exclusions for such country or region. In such case, please contact Customer Relations for further information.

## Maintenance

Maintain the vehicle regularly to sustain the road safety, operational reliability and the New Vehicle Limited Warranty.

Specifications for required maintenance measures:

- ▷ BMW Maintenance system

- ▷ Service and Warranty Information Booklet for US models
- ▷ Warranty and Service Guide Booklet for Canadian models

If the vehicle is not maintained according to these specifications, this could result in serious damage to the vehicle. Such damage is not covered by the BMW New Vehicle Limited Warranty.

## Data memory

Many electronic components on your vehicle are equipped with data memories that temporarily or permanently store technical information about the condition of the vehicle, events and faults. This technical information generally records the state of a component, a module, a system or the environment:

- ▷ Operating mode of system components, fill levels for instance.
- ▷ Status messages for the vehicle and from its individual components, e.g., wheel rotation speed/vehicle speed, deceleration, transverse acceleration.
- ▷ Malfunctions and faults in important system components, e.g., lights and brakes.
- ▷ Responses by the vehicle to special situations such as airbag deployment or engaging the stability control system.
- ▷ Ambient conditions, such as temperature.

This data is purely technical in nature and is used to detect and correct faults and to optimize vehicle functions. Motion profiles over routes traveled cannot be created from this data. When service offerings are used, e.g., repair services, service processes, warranty claims, quality assurance, this technical information can be read out from the event and fault memories by the service personnel, including the manufacturer, using special diagnostic tools. You can obtain further information there if you need it. After an error is corrected,

the information in the fault memory is deleted or overwritten on a continuous basis.

With the vehicle in use there are situations where you can associate these technical data with individuals if combined with other information, e.g., an accident report, damage to the vehicle, eye witness accounts — possibly with the assistance of an expert.

Additional functions that are contractually agreed with the customer - such as vehicle emergency locating - you can transmit certain vehicle data from the vehicle.

## Event Data Recorder EDR

This vehicle is equipped with an event data recorder EDR. The main purpose of an EDR is to record, in certain crash or near crash-like situations, such as an air bag deployment or hitting a road obstacle, data that will assist in understanding how a vehicle's systems performed. The EDR is designed to record data related to vehicle dynamics and safety systems for a short period of time, typically 30 seconds or less.

The EDR in this vehicle is designed to record such data as:

- ▶ How various systems in your vehicle were operating.
- ▶ Whether or not the driver and passenger safety belts were fastened.
- ▶ How far, if at all, the driver was depressing the accelerator and/or brake pedal.
- ▶ How fast the vehicle was traveling.

These data can help provide a better understanding of the circumstances in which crashes and injuries occur.

EDR data are recorded by your vehicle only if a nontrivial crash situation occurs; no data are recorded by the EDR under normal driving conditions and no personal data, e.g., name, gender, age, and crash location, are recorded.

However, other parties, such as law enforcement, could combine the EDR data with the type of personally identifying data routinely acquired during a crash investigation.

To read data recorded by an EDR, special equipment is required, and access to the vehicle or the EDR is needed. In addition to the vehicle manufacturer, other parties, such as law enforcement, that have the special equipment, can read the information if they have access to the vehicle or the EDR.

## Vehicle identification number

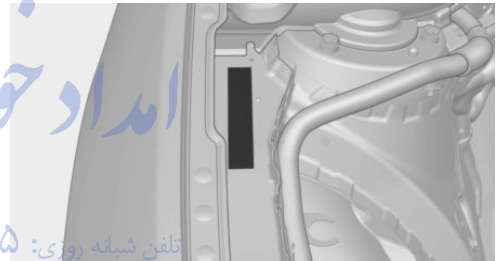

The vehicle identification number can be found in the engine compartment.

The vehicle identification number can also be found behind the windshield.

## Reporting safety defects

### For US customers

The following only applies to vehicles owned and operated in the US.

If you believe that your vehicle has a defect which could cause a crash or could cause injury or death, you should immediately inform the National Highway Traffic Safety Administration NHTSA, in addition to notifying BMW of North America, LLC, P.O. Box 1227, Westwood, New Jersey 07675-1227, Telephone 1-800-831-1117.

If NHTSA receives similar complaints, it may open an investigation, and if it finds that a safety defect exists in a group of vehicles, it may order a recall and remedy campaign.

However, NHTSA cannot become involved in individual problems between you, your dealer, or BMW of North America, LLC.

To contact NHTSA, you may call the Vehicle Safety Hotline toll-free at 1-888-327-4236 (TTY: 1-800-424-9153); go to <http://www.safercar.gov>; or write to: Administrator, NHTSA, 400 Seventh Street, SW., Washington, DC 20590. You can also obtain other information about motor vehicle safety from <http://www.safercar.gov>.

### For Canadian customers

Canadian customers who wish to report a safety-related defect to Transport Canada, Defect Investigations and Recalls, may call the toll-free hotline 1-800-333-0510. You can also obtain other information about motor vehicle safety from <http://www.tc.gc.ca/roadsafety>.

تلفن شبانه روزی: ۰۲۱-۸۸۸۶۲۰۸۵

FarmaSOS.com

# امداد خودرو فارما

تلفن شبانه روزی: ۰۲۱-۸۸۸۶۲۰۸۵

**FarmaSOS.com**



# امداد خودرو فارما

تلفن شماره اورژانس: ۰۲۱-۸۸۸۶۲۰۸۵

[FarmaSOS.com](http://FarmaSOS.com)



## At a glance

These overviews of buttons, switches and displays are intended to familiarize you with your vehicle. You will also become quickly acquainted with the available control concepts and options.

امداد خودرو فارما

تلفن شبانه روزی: ۰۲۱-۸۸۸۶۲۰۸۵

FarmaSOS.com

# Cockpit

## Vehicle features and options

This chapter describes all standard, country-specific and optional features offered with the series. It also describes features that are not

necessarily available in your car, e. g., due to the selected options or country versions. This also applies to safety-related functions and systems.

## All around the steering wheel

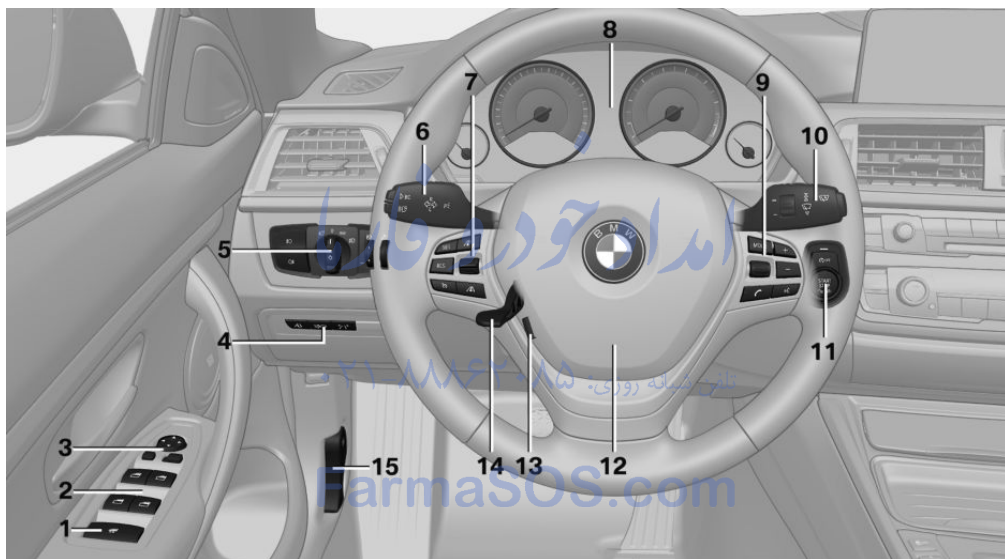

- 1 Power windows, all 45
- 2 Power windows, individual 45
- 3 Exterior mirror operation 58
- 4 Glove compartment on the driver's side 163

### Driver assistance systems



Active Blind Spot Detection 115



Intelligent Safety 105



Lane departure warning 114

- 5 Lights

























Front fog lights 94



Parking lights 91









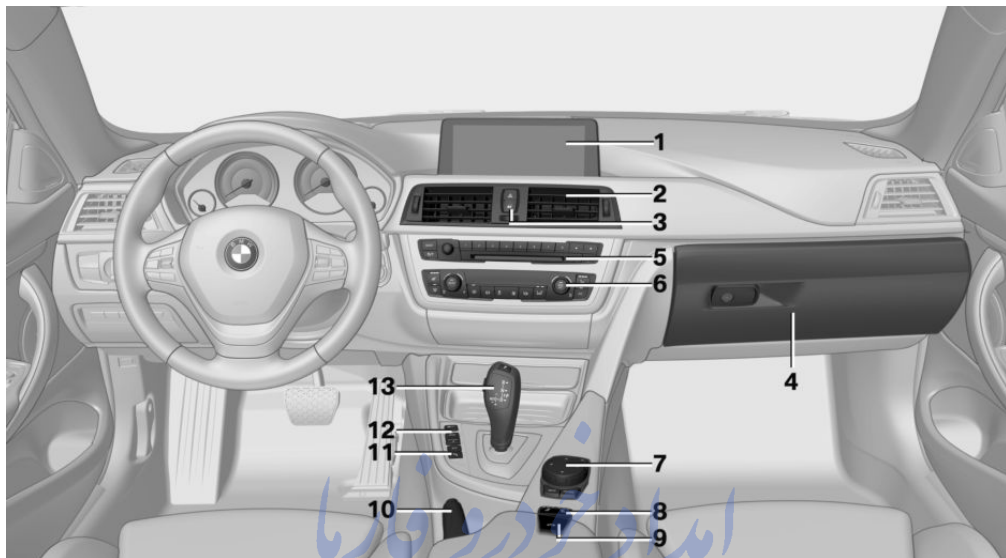

Low beams 91

-  Automatic headlight control [92](#)  
 Daytime running lights [92](#)  
 Adaptive Light Control [92](#)  
 High-beam Assistant [93](#)  
 Instrument lighting [94](#)
-  **6** Steering column stalk, left
-  Turn signal [68](#)
-  High beams, headlight flasher [68](#)
-  High-beam Assistant [93](#)
-  Roadside parking lights [92](#)
-  Computer [85](#)
- 7** Steering wheel buttons, left
-  Store speed [130](#), [124](#)
-  Resume speed [132](#), [124](#)
-  Cruise control on/off, interrupting [131](#)
-  Active Cruise Control on/off, interrupting [124](#)
-  Reduce distance [127](#)
-  Increase distance [127](#)
- Cruise control rocker reel [132](#), [126](#)
- 8** Instrument cluster [76](#)
- 9** Steering wheel buttons, right
-  Entertainment source
-  Volume
-  Voice activation [26](#)
-  Telephone, see user's manual for Navigation, Entertainment and Communication
- Thumbwheel for selection lists [85](#)
- 10** Steering column stalk, right
-  Wiper [69](#)
-  Rain sensor [70](#)
-  Clean the windshields and headlights [70](#)
- 11**  Start/stop the engine and reel the ignition on/off [65](#)
-  Auto Start/Stop function [66](#)
- 12** Horn, total area
- 13**  Steering wheel heating [60](#)
- 14** Adjust steering wheel [60](#)
- 15** Unlock hood [199](#)





## All around the center console



- 1 Control Display 18
- 2 Ventilation 151
- 3  Hazard warning system 215
- 4  Central locking system 39
- 5 Radio/CD/Multimedia, see user's manual for Navigation, Entertainment and Communication
- 6 Climate control 145
- 7 Controller with buttons 18
- 8 Neck warmer 54
- 9 Hardtop 46
- 10 Parking brake 67
- 11  PDC Park Distance Control 132
- 11  Rearview camera 135
- 11  Parking assistant 140
- 11  Surround View 135
- 11  Side View 137
- 12  Driving Dynamics Control 121
- 12  DSC Dynamic Stability Control 119
- 13 Steptronic transmission selector lever 72

## All around the roofliner



- |   |   |  |   |   |   |
|---|---|--|---|---|---|
| 1 |  | Intelligent Emergency Re-<br>quest 215 | 3 |  | Interior lights 94                                  |
| 2 |  | Reading lights 94                      | 4 |  | Indicator lamp, front-seat pas-<br>senger airbag 98 |

FarmaSOS.com

# iDrive

## Vehicle features and options

This chapter describes all standard, country-specific and optional features offered with the series. It also describes features that are not necessarily available in your car, e. g., due to the selected options or country versions. This also applies to safety-related functions and systems.

## The concept

The iDrive combines the functions of many switches. Thus, these functions can be operated from a central location.



Using the iDrive during a trip

To avoid becoming distracted and posing an unnecessary hazard to your vehicle's occupants and to other traffic, never attempt to use the controls or enter information unless traffic and road conditions allow it. ◀

## Control elements at a glance

### Control elements

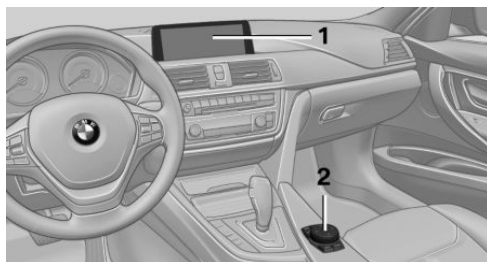

- 1 Control Display
- 2 Controller with buttons and, depending on the equipment version, with touchpad

## Control Display

### Hints

- ▶ To clean the Control Display, follow the care instructions.
- ▶ Do not place objects close to the Control Display; otherwise, the Control Display can be damaged.
- ▶ In the case of very high temperatures on the Control Display, e.g. due to intense solar radiation, the brightness may be reduced down to complete deactivation. Once the temperature is reduced, e.g. through shadow or climate control system, the normal functions are re-established.

### Switching on

1. Switch on the ignition.
2. Press the controller.

### Switch off

1.  Press button.
2. "Turn off control display"

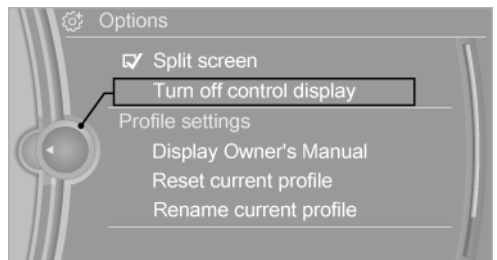

## Controller with navigation system

The buttons can be used to open the menus directly. The controller can be used to select menu items and enter the settings.

Some iDrive functions can be operated using the touchpad on the controller.

## 1. Turn.

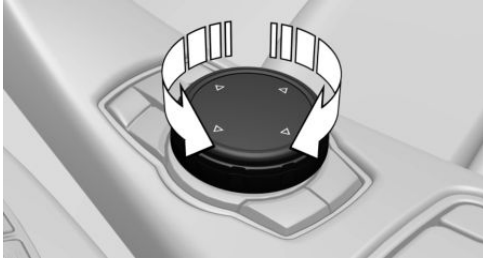

## 2. Press.

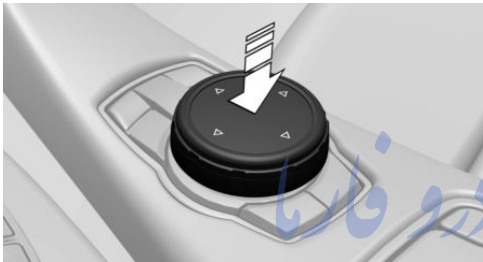

## 3. Move in four directions.

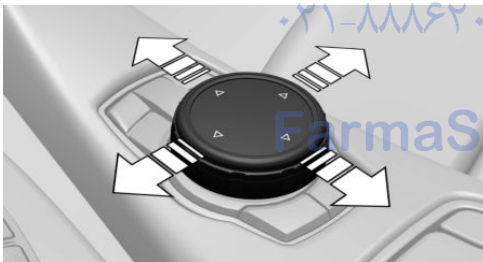

## Buttons on controller

| Press button | Function                   |
|--------------|----------------------------|
| MENU         | Open the main menu.        |
| RADIO        | Opens the Radio menu.      |
| MEDIA        | Opens the Multimedia menu. |
| NAV          | Opens the Navigation menu. |
| TEL          | Opens the phone menu.      |

| Press button | Function                     |
|--------------|------------------------------|
| BACK         | Displays the previous panel. |
| OPTION       | Opens the Options menu.      |

## Controller without navigation system

The buttons can be used to open the menus directly. The controller can be used to select menu items and enter the settings.

## 1. Turn.

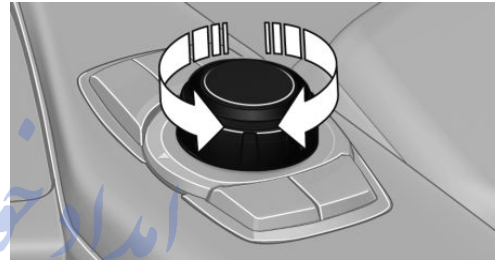

## 2. Press.

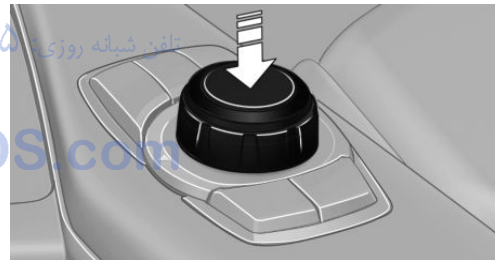

## 3. Move in two directions.

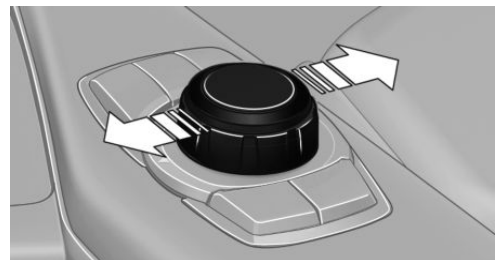

## Buttons on controller

| Press button | Function  |
|--------------|---|
| MENU         | Open the main menu.   |
| Audio        | Open audio menu last listened to, reel between audio menus. |
| TEL          | Opens the phone menu.                                       |
| BACK         | Open previous panel.  |
| OPTION       | Opens the Options menu.                                     |

## Operating concept

### Opening the main menu

 Press button.

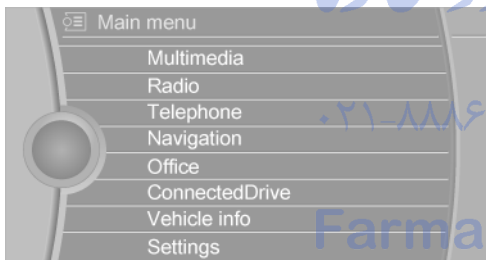

The main menu is displayed.

All iDrive functions can be called up via the main menu.

### Selecting menu items

Highlighted menu items can be selected.

1. Turn the controller until the desired menu item is highlighted.

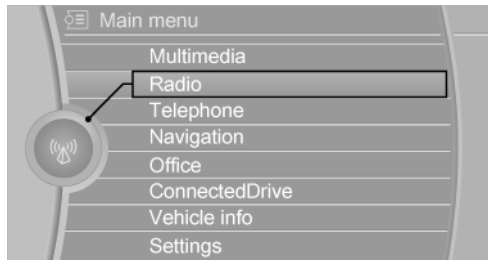

2. Press the controller.

### Menu items in the Owner's Manual

In the Owner's Manual, menu items that can be selected are set in quotation marks, e.g., "Settings".

### Changing between panels

After a menu item is selected, e.g., "Radio", a new panel is displayed. Panels can overlap.

- ▶ Move the controller to the left.
  - Closes current display and shows previous display.
  - Reopens previous display by pressing BACK button. In this case, the current panel is not closed.
- ▶ Move the controller to the right.
  - Opens new display on top of previous screen.

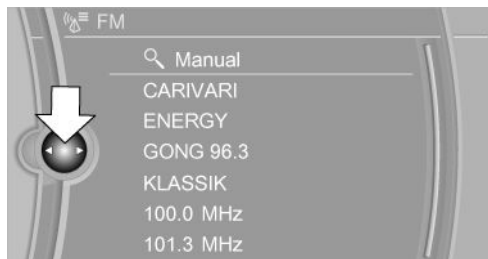



White arrows pointing to the left or right indicate that additional panels can be opened.

## Display of an opened menu

When selecting a menu, it generally opens with the panel that was last selected in that menu. To display the first panel of a menu:

- Move the controller to the left repeatedly until the first panel is displayed.
- Press the menu button on the controller twice.

## Opening the Options menu



Press button.

The "Options" menu is displayed.

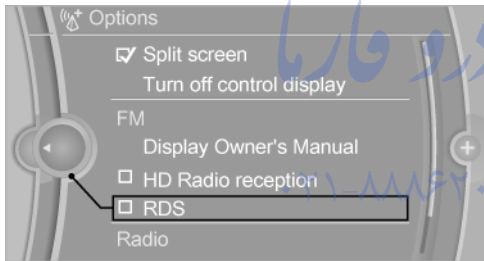

Additional options: move the controller to the right repeatedly until the "Options" menu is displayed.

## Options menu

The "Options" menu consists of various areas:

- Screen settings, e.g., "Split screen".  
This area remains unchanged.
- Control options for the selected main menu, e.g., for "Radio".
- If applicable, further operating options for the selected menu, e.g., "Store station".

## Changing settings

1. Select a field.

2. Turn the controller until the desired setting is displayed.

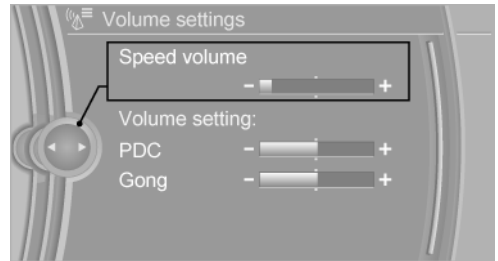

3. Press the controller.

## Activating/deactivating the functions

Several menu items are preceded by a checkbox. It indicates whether the function is activated or deactivated. Selecting the menu item activates or deactivates the function.

- Function is activated.
- Function is deactivated.

## Touchpad

Some iDrive functions can be operated using the touchpad on the controller:

### Selecting functions

1. "Settings"
2. "Touchpad"
3. Select the desired function.
  - "Speller": enter letters and numbers.
  - "Interactive map": viewing the interactive map.
  - "Browser": enter Internet addresses.
  - "Audio feedback": pronounces entered letters and numbers.

## Entering letters and numbers

Entering letters requires some practice at the beginning. When entering, pay attention to the following:

- ▶ For the input of upper/lower case letters and numbers, it may be necessary to reel via the controller to the corresponding Input mode, refer to page 25, e.g. when the spelling of upper and lower case letters is identical.
- ▶ Enter characters as they are displayed on the Control Display.
- ▶ Always enter associated characters, such as accents or periods so that the letter can be clearly recognized. Possible input depends on the set language. Where necessary, enter special characters via the controller.
- ▶ To delete a character, slide to the left on the touchpad.
- ▶ To enter a blank space, slide to the right in the center of the touchpad.
- ▶ To enter a hyphen, slide to the right in the upper area of the touchpad.
- ▶ To enter an underscore, swipe to the right in the lower area of the touchpad.

## Using interactive map and Internet

Via touch-pad move the interactive map in the navigation system and Internet sites.

| Function  | Controls                                     |
|---|--|
| Move interactive map or Internet sites.           | Swipe into respective direction.             |
| Enlarge/shrink interactive map or Internet sites. | Drag in or out on the touchpad with fingers. |
| Display the menu or open a link in the Internet.  | Tap once.                                    |

## Changing settings

You may change control display settings via touchpad. Swipe left or right accordingly.

## Example: setting the clock

### Setting the clock

On the Control Display:

1.  Press button. The main menu is displayed.
2. Turn the controller until "Settings" is highlighted, and then press the controller.

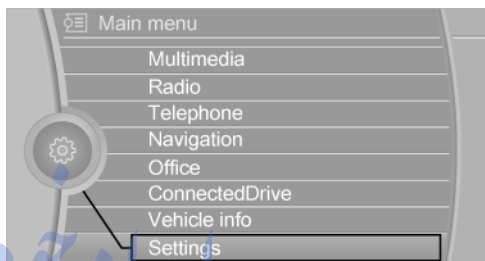

3. If necessary, move the controller to the left to display "Time/Date".
4. Turn the controller until "Time/Date" is highlighted, and then press the controller.



5. Turn the controller until "Time:" is highlighted, and then press the controller.



- Turn the controller to set the hours and press the controller.
- Turn the controller to set the minutes and press the controller.

## Status information

### Status field



The following information is displayed in the status field at the top right:

- Time.
- Current entertainment source.
- Sound output, on/off.
- Wireless network reception strength.
- Phone status.
- Traffic bulletin reception.







### Status field symbols





The symbols are grouped as follows.

#### Radio symbols







| Symbol  | Meaning                             |
|---|-------------------------------------|
|   | HD radio station is being received. |
|  | Satellite radio is switched on.     |

#### Telephone symbols

| Symbol   | Meaning   |
|--|---|
|  | Incoming or outgoing call.  |
|  | Missed call.  |
|  | Wireless network reception strength.<br>Symbol flashes: network search. |
|  | Wireless network is not available.                                      |
|  | Bluetooth is switched on.   |
|  | Roaming is active.  |

| Symbol  | Meaning                    |
|---|----------------------------|
|  | Text message was received. |
|  | Check the SIM card.        |
|  | SIM card is blocked.       |
|  | SIM card is missing.       |
|  | Enter PIN.                 |

#### Entertainment symbols

| Symbol  | Meaning                       |
|---|-------------------------------|
|  | CD/DVD player.                |
|  | Music collection.             |
|  | Gracenote® database.          |
|  | AUX-IN port.                  |
|  | USB audio interface.          |
|  | Mobile phone audio interface. |

#### Additional symbols

| Symbol  | Meaning                             |
|---|-------------------------------------|
|  | Spoken instructions are turned off. |

## Split screen

### General information

Additional information can be displayed on the right side of the split screen, e.g., information from the computer.

In the divided screen view, the so-called split screen, this information remains visible even when you change to another menu.

### Switching the split screen on and off

-  Press button.
- "Split screen"

## Selecting the display

1.  Press button.
2. "Split screen"
3. Move the controller until the split screen is selected.
4. Press the controller or select "Split screen content".
5. Select the desired menu item.

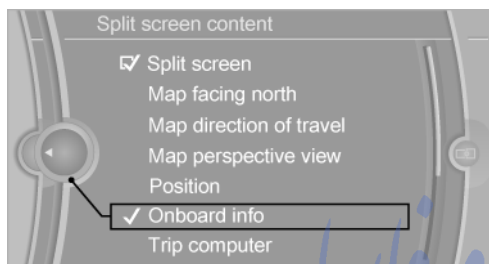

## Programmable memory buttons

### General information

The iDrive functions can be stored on the programmable memory buttons and called up directly, e.g., radio stations, navigation destinations, phone numbers and menu entries.

Settings are stored for the profile currently in use.

### Without navigation system and telephone

Only radio stations can be stored on the buttons, refer to user's manual for Navigation, Entertainment, Communication.

### Saving a function

1. Highlight the function via the iDrive.
2.  Press and hold the desired button, until a signal sounds.

## Running a function

- 1... Press button.
- The function will work immediately. This means, e.g., that the number is dialed when a phone number is selected.

## Displaying the button assignment

Touch buttons with bare fingers. Do not wear gloves or use objects.

The key assignment is displayed at top edge of screen.

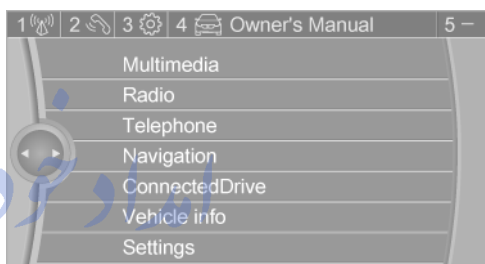

## Deleting the button assignments

1. Press buttons 1 and 8 simultaneously for approx. five seconds.
2. "OK"

## Deleting personal data in the vehicle

### The concept

Depending on the usage, the vehicle saves personal data, such as stored radio stations. These personal data can be permanently deleted through iDrive.

### General information

Depending on the equipment package, the following data can be deleted:

- ▷ Personal Profile settings.
- ▷ Stored radio stations.
- ▷ Stored Favorites buttons.

- ▷ Travel and computer information.
- ▷ Music collection.
- ▷ Navigation, e.g. stored destinations.
- ▷ Phone book.
- ▷ Online data, e.g. Favorites, cookies.
- ▷ Voice notes.
- ▷ Login accounts.
- ▷ RemoteApp smartphone tethering.

Altogether, the deletion of the data can take up to 30 minutes.

### Functional requirement

Data can only be deleted while stationary.

### Deleting data

Heed and follow the instructions on the Control Display.

1. Switch on the ignition.
2. "Settings"
3. Open "Options".
4. "Delete personal data"
5. "Continue"
6. "OK"

## Entering letters and numbers

### General information

On the Control Display:

1. Turn the controller: select letters or numbers.
2. Select additional letters or numbers if needed.
3. "OK": confirm the entry.

| Symbol | Function  |
|--------|---|
| ⬅      | Press the controller: delete the letter or number.                          |
| ⬅      | Press the controller for an extended period: delete all letters or numbers. |

### Switching between cases, letters and numbers

Depending on the menu, you can reel between entering upper and lower case, letters and numbers:

| Symbol           | Function           |
|------------------|--------------------|
| A <sup>B</sup> c | Enter the letters. |
| 1@+              | Enter the numbers. |
| abc or ABC       | Tip controller up. |

### Without navigation system

@<sup>A</sup> A<sup>a</sup> a<sup>@</sup> Select the symbol.

### Entry comparison

Entering names and addresses: choice is narrowed down with every letter entered and letters may be added automatically.

Entries are continuously compared with data stored in the vehicle.

- ▷ Only those letters are offered during input for which data is available.
- ▷ Target search: names of locations may be entered in languages available through Control Display.

# Voice activation system

## Vehicle features and options

This chapter describes all standard, country-specific and optional features offered with the series. It also describes features that are not necessarily available in your car, e. g., due to the selected options or country versions. This also applies to safety-related functions and systems.

## The concept

- ▷ Most functions displayed on the Control Display can be operated by voice commands via the voice activation system. The system supports you with announcements during input.
- ▷ Functions that can only be used when the vehicle is stationary cannot be used via the voice activation system.
- ▷ The system uses a special microphone on the driver's side.
- ▷ ›...‹ Verbal instructions in the Owner's Manual to use with the voice activation system.

## Requirements

Via the Control Display, set a language that is also supported by the voice activation system so that the spoken commands can be identified.

Set the language, refer to page 88.

## Using voice activation

### Activating the voice activation system

1.  Press button on the steering wheel.
2. Wait for the signal.
3. Say the command.

A command that is recognized by the voice activation system is announced and displayed in the instrument cluster.

 This symbol in the instrument cluster indicates that the voice activation system is active.

If no other commands are available, use function via iDrive.

### Terminating the voice activation system

 Briefly press the button on the steering wheel or ›Cancel‹.

## Possible commands

Most menu items on the Control Display can be voiced as commands.

The available commands depend on the menu that is currently displayed on the Control Display.

There are short commands for many functions.

You may select lists such as phone lists via voice activation. Read these lists out loud exactly as they show in the respective list.

### Having possible commands read aloud

You can have available commands read out loud for you: ›Voice commands‹

E. g. if the "Settings" menu is displayed, the commands for the settings are read out loud.

## Executing functions using short commands

Execute functions on the main menu via short commands. It almost doesn't matter which menu item is selected, e.g., ›Vehicle status‹.

List of short commands for the voice activation system, see Navigation, Entertainment, Communication Owner's Manual.

## Help dialog for the voice activation system

Calling up help dialog: ›Help‹

Additional commands for the help dialog:

- ▶ ›Help with examples‹: announces information about the current operating options and the most important commands for them.
- ▶ ›Help with voice activation‹: information about the principle of operation for the voice activation system is announced.

## One example: open the tone settings

### Via the main menu

The commands of the menu items are spoken just as they are selected via the controller.

1. Turn on the Entertainment sound output if needed.
2.  Press button on the steering wheel.
3. ›Radio‹
4. ›Tone‹

### Via short command

The desired tone settings can also be started via a short command.

1. Turn on the Entertainment sound output if needed.

2.  Press button on the steering wheel.
3. ›Tone‹

## Setting the voice dialog

Set system to standard dialog or use a short version.

The short version of the voice dialog plays back short messages in abbreviated form.

1. "Settings"
2. "Language/Units"
3. "Speech type:"
4. Select setting.



## Adjusting the volume

Turn the volume button while giving an instruction until the desired volume is set.

- ▶ The volume remains constant even if the volume of other audio sources is changed.
- ▶ The volume is stored for the profile currently in use.

## Hints on Emergency Requests

Do not use the voice activation system to initiate an Emergency Request. In stressful situations, the voice and vocal pitch can change.

This can unnecessarily delay the establishment of a phone connection.

Instead, use the SOS button, refer to page 215, close to the interior mirror.

## Environmental conditions

- ▷ Say the commands, numbers, and letters smoothly and with normal volume, emphasis, and speed.
- ▷ Always say commands in the language of the voice activation system.
- ▷ Keep the doors, windows, and lowerable hardtop closed to prevent noise interference.
- ▷ Avoid making other noise in the vehicle while speaking.

امداد خودرو فارما

تلفن شبانه روزی: ۰۲۱-۸۸۸۶۲۰۸۵

FarmaSOS.com



# Integrated Owner's Manual in the vehicle

## Vehicle features and options

This chapter describes all standard, country-specific and optional features offered with the series. It also describes features that are not necessarily available in your car, e. g., due to the selected options or country versions. This also applies to safety-related functions and systems.

## Integrated Owner's Manual in the vehicle

The Integrated Owner's Manual can be displayed on the Control Display. It specifically describes features and functions found in the vehicle.

### Components of the Integrated Owner's Manual

The Integrated Owner's Manual consists of three parts, which offer various levels of information or possible access.

#### Quick Reference Guide

The Quick Reference Guide provides information how to operate the car, how to use basic vehicle functions or what to do in case of a breakdown. This information can also be displayed while driving.

#### Search by images

Image search provides information and descriptions. This is helpful when the terminology for a feature is not at hand.

#### Owner's Manual

Search for information and descriptions by entering terms selected from the index.

## Select components

1.  Press button.
2. Turn the controller: open "Vehicle info".
3. Press the controller.
4. Selecting desired range:
  - ▷ "Quick reference"
  - ▷ "Search by pictures"
  - ▷ "Owner's Manual"

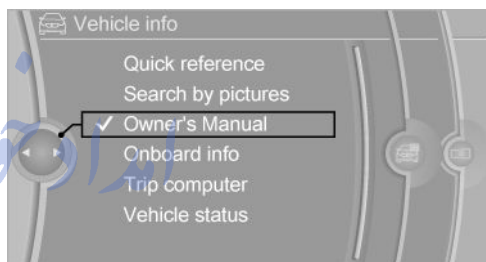

## Leafing through the Owner's Manual

### Page by page with link access

Turn the controller until the next or previous page is displayed.

### Page by page without link access

Scroll through the pages directly while skipping the links.

Highlight the symbol once. Now simply press the controller to browse from page to page.



Scroll back.



Scroll forward.

## Context help - Owner's Manual to the temporarily selected function

You may open the relevant information directly.

### Opening via the iDrive

To move directly from the application on the Control Display to the Options menu:

1.  Press button or move the controller to the right repeatedly until the "Options" menu is displayed.
2. "Display Owner's Manual"



### Opening when a Check Control message is displayed

Directly from the Check Control message on the Control Display:

"Display Owner's Manual"

### Changing between a function and the Owner's Manual

To reel from a function, e. g., radio, to the Owner's Manual on the Control Display and to alternate between the two displays:

1.  Press button or move the controller to the right repeatedly until the "Options" menu is displayed.
2. "Display Owner's Manual"
3. Select the desired page in the Owner's Manual.
4.  Press button again to return to last displayed function.
5.  Press button to return to the page of the Owner's Manual displayed last.

To alternate permanently between the last displayed function and the Owner's Manual repeat steps 4 & 5. Opens a new display every time.

## Programmable memory buttons

### General information

The Owner's Manual can be stored on the programmable memory buttons and called up directly.

### Storing

1. "Owner's Manual" Select via the iDrive.
2.  Press selected button for more than 2 seconds.

### Executing

1.  Press button. The Owner's Manual is displayed immediately.

امداد خودرو فارما

تلفن شبانه روزی: ۰۸۵ ۸۸۶۲۰۸۵

FarmaSOS.com

# امداد خودرو فارما

تلفن شبانه روزی: ۰۲۱-۸۸۸۶۲۰۸۵

**FarmaSOS.com**



START  
STOP  
ENGINE

امداد خودرو فارما

تلفن شبانه روزی: ۰۲۱-۸۸۸۶۲۰۸۵

[FarmaSOS.com](http://FarmaSOS.com)

## Controls

This chapter is intended to provide you with information that will give you complete control of your vehicle. All features and accessories that are useful for driving and your safety, comfort and convenience are described here.

تلفن شبانه روزی: ۰۲۱-۸۸۸۶۲۰۸۵

FarmaSOS.com

# Opening and closing

## Vehicle features and options

This chapter describes all standard, country-specific and optional features offered with the series. It also describes features that are not necessarily available in your car, e. g., due to the selected options or country versions. This also applies to safety-related functions and systems.

## Remote control/key

### General information

The vehicle is supplied with two remote controls with integrated key.

Every remote control holds a replaceable battery.

You may set the key functions depending on the optional features and country-specific version. For Settings, refer to page 42.

The vehicle stores personal settings for every remote control. Personal Profile, refer to page 35.

The remote controls hold information on required maintenance. Service data in the remote control, refer to page 204.

### At a glance

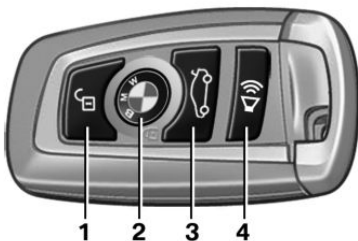

- 1 Unlocking
- 2 Locking

- 3 Unlocking the trunk lid
- 4 Panic mode

### Integrated key

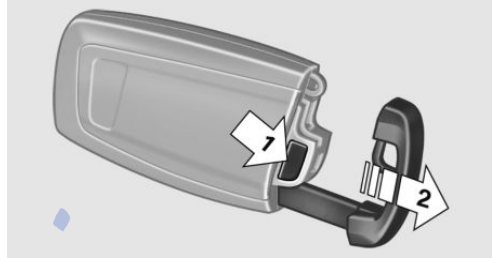

Press button on the back of the remote control, arrow 1, and pull out the key, arrow 2.

The integrated key fits the following locks:

- ▷ Driver's door.

### Replacing the battery

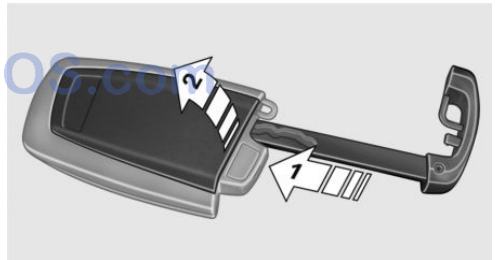

1. Remove integrated key from remote control.
2. Push in the catch with the key, arrow 1.
3. Remove the cover of the battery compartment, arrow 2.
4. Insert a battery of the same type with the positive side facing up.
5. Press the cover closed.



Take the used battery to a recycling center or to your service center.

## New remote controls

New remote controls are available from the service center.

## Loss of the remote controls

Lost remote controls can be disabled by your service center.

## Emergency detection of remote control

It is possible to reel on the ignition or start the engine in situations such as the following:

- ▷ Interference of radio transmission to remote control by external sources e.g., by radio masts.
- ▷ Empty battery in remote control.
- ▷ Interference from radio transmissions through mobile devices in close proximity to remote control.
- ▷ Interference of radio transmission by charger while charging items such as mobile devices in the vehicle.

A Check Control message is displayed if an attempt is made to reel on the ignition or start the engine.

## Starting the engine with emergency detection of the remote control

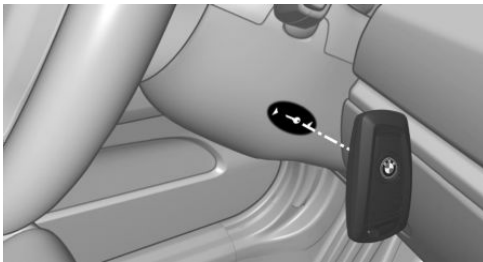

Steptronic transmission: if a corresponding Check Control message appears, hold the remote control, as shown, against the marked

area on the steering column and press the Start/Stop button within 10 seconds while pressing the brake.

If the remote control is not recognized: slightly change the height position of the remote control and repeat the procedure.

## Personal Profile

### The concept

Individual settings in the vehicle are saved in personal profiles. Every remote control is assigned the last active profile.

Three personal profiles and a guest profile can be created.

- ▷ Changes to the settings are automatically saved in the profile currently activated.
- ▷ Unlocking the car activates the profile that is stored in the remote control.
- ▷ Your personal settings will be recognized and activated even if the vehicle had been operated with another remote control.

### Adjusting

The settings for the following systems and functions are saved in the active profile. The scope of storable settings is country- and equipment-dependable.

- ▷ Unlocking and locking.
- ▷ Lights.
- ▷ Climate control.
- ▷ Radio.
- ▷ Instrument cluster.
- ▷ Programmable memory buttons.
- ▷ Volumes, tone.
- ▷ Control Display.
- ▷ Navigation.
- ▷ Park Distance Control PDC.
- ▷ Rearview camera
- ▷ Side View.

- ▷ Head-up Display.
- ▷ Driving Dynamics Control.
- ▷ Cruise control.
- ▷ Intelligent Safety.
- ▷ Active Blind Spot Detection.

## Profile management

### Opening profiles

Regardless of the remote control in use a different profile may be activated.

1. "Settings"
2. "Profiles"
3. Select a profile.

The activated profile is assigned to the currently used remote control.

### Renaming profiles

1. "Settings"
2. "Profiles"
3. "Options"
4. "Rename current profile"

### Resetting profiles

The settings of the active profile are reset to their default values.

1. "Settings"
2. "Profiles"
3. "Options"
4. "Reset current profile"

### Exporting profiles

Most settings of the active profile and the saved contacts can be exported.

This can be helpful for securing and retrieving personal settings, before delivering the vehicle to a workshop, e.g. Profiles can be taken to another vehicle equipped with the Personal Profile function.

The following export options are available:

- ▷ Via BMW Online.
- ▷ Via the USB port to a USB device.

Popular file systems for USB devices are supported. FAT32 and exFAT are the recommended formats for profile export. Other formats may not support the export.

1. "Settings"
2. "Profiles"
3. "Export profile"
4. BMW Online: "BMW Online"  
USB interface: "USB device"

### Importing profiles

Profiles exported via BMW Online can also be imported via BMW Online.

Profiles stored on a USB device can be imported via the USB interface.

Existing settings and contacts are overwritten with the imported profile.

1. "Settings"
2. "Profiles"
3. "Import profile"
4. BMW Online: "BMW Online"  
USB interface: "USB device"

### Using the guest profile

The guest profile is for individual settings that are saved in none of the three personal profiles.

This can be useful for drivers who are using the vehicle temporarily and do not have their own profile.

1. "Settings"
2. "Profiles"
3. "Guest"

The guest profile cannot be renamed. It is not assigned to the current remote control.



## Display profile list during start

The profile list can be displayed during each start to select the desired profile.

1. "Settings"
2. "Profiles"
3. "Options"
4. "Display user list at startup"

## Using the remote control

### Note

 Take the remote control with you. People or animals left unattended in a parked vehicle can lock the doors from the inside. Always take the remote control with you when leaving the vehicle so that the vehicle can then be opened from the outside. ◀

### Unlocking

 Press button on the remote control.

- ▶ All doors and the trunk lid are unlocked.
- ▶ Interior lamps and courtesy lamps are activated. This function is not available, if the interior lamps were switched off manually.
- ▶ The welcome lamps are switched on, if this function was activated.
- ▶ Exterior mirrors folded through convenient closing are folded open.

You can set how the vehicle is to be unlocked. For Settings, refer to page 42.

The alarm system, refer to page 43, is disarmed.

### Convenient opening

 Press and hold this button on the remote control.

The windows are opened, as long as the button on the remote control is pressed.

With Comfort Access, the remote control can be used to open the hardtop when in the vicinity of the vehicle.

 Press and hold this button on the remote control until the hardtop is fully opened and the hardtop well storage cover is fully closed.

 Danger of jamming. Monitor the opening process to ensure that no one becomes trapped; otherwise, injuries may result. ◀

Leaving the vicinity of the vehicle stops the motion.

### Locking

 Locking from the outside. Do not lock the vehicle from the outside with people inside the car, as the vehicle cannot be unlocked from inside without special knowledge. ◀

 Press button on the remote control.

All doors and the trunk lid are locked.

The alarm system, refer to page 43, is armed.

### Convenient closing

With Comfort Access, the hardtop and the window can be closed while you are close to the vehicle.

 Hold down the remote control button until the closing operation is completed.

Releasing the button or leaving the vicinity of the vehicle stops the motion.

 Monitor closing. Monitor closing to ensure that no one becomes trapped. ◀

## Switching on interior lights and courtesy lights



Press button on the remote control with the vehicle locked.

This function is not available, if the interior lamps were switched off manually.

If the button is pressed again within 10 seconds after vehicle was locked, the interior motion sensor and tilt alarm sensor of the anti-theft warning system, refer to page 44, are turned off. After locking, wait 10 seconds before pressing the button again.

## Panic mode

You can trigger the alarm system if you find yourself in a dangerous situation.



Press button on the remote control for at least 3 seconds.

To reel off the alarm: press any button.

## Unlocking the trunk lid



Press button on the remote control for approx. 1 second.

The trunk lid opens slightly, regardless of whether the vehicle was previously locked or unlocked.

Depending on the features and the country version, it is also possible to have door unlocked. Create the settings, refer to page 42.

If the doors were not unlocked, the trunk lid is locked again as soon as it closes.



Do not place the remote control in the cargo area

Take the remote control with you and do not leave it in the cargo area; otherwise, the remote control is locked inside the vehicle when the trunk lid is closed. ◀

## Malfunction

Remote control detection by the vehicle can among others be malfunctioning under the following circumstances:

- ▷ Interference of the radio connection from transmission towers or other equipment with high transmit power.
- ▷ Shielding of the remote control due to metal objects.
- ▷ Interference of the radio connection from mobile phones or other electronic devices in direct proximity.

Do not transport the remote control together with metal objects or electronic devices.

In the case of interference, the vehicle can also be unlocked and locked from the outside without remote control, refer to page 39.

### For US owners only

The transmitter and receiver units comply with part 15 of the FCC/Federal Communication Commission regulations. Operation is governed by the following:

FCC ID:

- ▷ LX8766S.
- ▷ LX8766E.
- ▷ LX8CAS.
- ▷ LX8CAS2.
- ▷ MYTCAS4.

Compliance statement:

This device complies with part 15 of the FCC Rules. Operation is subject to the following two conditions:

- ▷ This device may not cause harmful interference, and
- ▷ this device must accept any interference received, including interference that may cause undesired operation.

Any unauthorized modifications or changes to these devices could void the user's authority to operate this equipment.

## Without remote control

### From the outside



Locking from the outside

Do not lock the vehicle from the outside with people inside the car, as the vehicle cannot be unlocked from inside without special knowledge. ◀



Remove the key before pulling the door handle

Before pulling the outside door handle, remove the key to avoid damaging the paintwork and the key. ◀

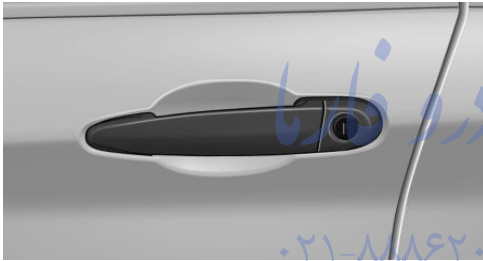

Unlock or lock the driver's door via the door lock using the integrated key, refer to page 34. The other doors must be unlocked or locked from the inside.

### Alarm system

The alarm system is not armed if the vehicle is locked with the integrated key.

The alarm system is triggered when the door is opened, if the vehicle was unlocked via the door lock.

In order to terminate this alarm, unlock vehicle with the remote control or reel on the ignition, if needed, through emergency detection of the remote control, refer to page 35.

### From the inside

### Unlocking and locking



Pressing the central locking system button locks or unlocks the vehicle with the doors closed.

The vehicle is not secured against theft when locking.

The fuel filler flap remains unlocked.

In the event of a severe accident, the vehicle is automatically unlocked. The hazard warning system and interior lights come on.

### Unlocking and opening

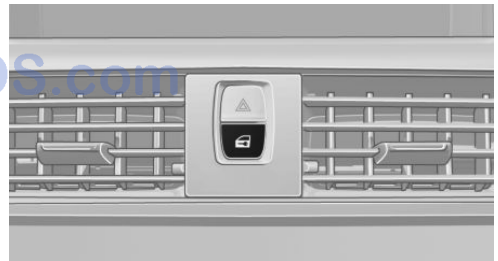

- ▶ Press the central locking system button to unlock the doors together, and then pull the door handle above the armrest.
- ▶ On the door to be opened, pull the door handle twice: the first time unlocks the door, the second time opens it. The other doors remain locked.

## Trunk lid

### Opening

During opening, the trunk lid pivots back and up.

Ensure that adequate clearance is available before opening.

### Opening from the outside

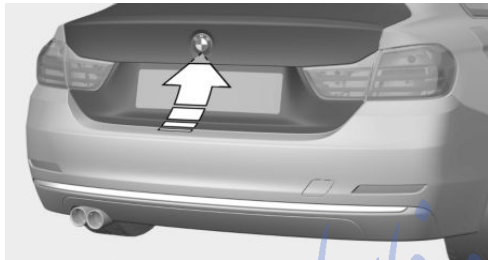

- ▷ Press button on the trunk lid.
- ▷  Press button on the remote control for approx. 1 second.  
As the case may be, the doors are also unlocked. Unlocking with the remote control, refer to page 38.

The trunk lid is unlocked and can be swung upward.

The trunk lid cannot be opened if the hardtop is not fully opened or closed.

### Opening from the inside

- ▷  With the vehicle is stationary, press the button in the driver's footwell.

The trunk lid is unlocked and opens slightly.

### Closing

#### Hints

- ▷  Keep the closing path clear  
Make sure that the closing path of the trunk lid is clear; otherwise, injuries may result. ◀



Do not place the remote control in the cargo area

Take the remote control with you and do not leave it in the cargo area; otherwise, the remote control is locked inside the vehicle when the trunk lid is closed. ◀

### Closing

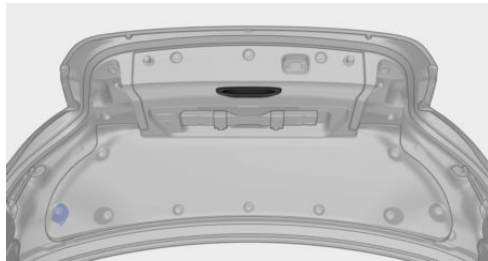

Recessed grips in the interior trim of the trunk lid make it easier to pull down the lid.



The loading aid, refer to page 160, can be operated using the trunk lid buttons.

### Locking separately

The trunk lid can be locked separately with the reel in the glove compartment. If the glove compartment is locked, the trunk lid cannot be opened.



- ▷ Trunk lid secured, arrow 1.
- ▷ Trunk lid not secured, arrow 2.

Slide the reel into the arrow 1 position. This secures the trunk lid and disconnects it from the central locking system.

This is beneficial when the vehicle is parked using valet service. The infrared remote control can be handed out without the key.

## Emergency unlocking



Pull the handle inside the cargo area.  
The trunk lid unlocks.

## Unlocking

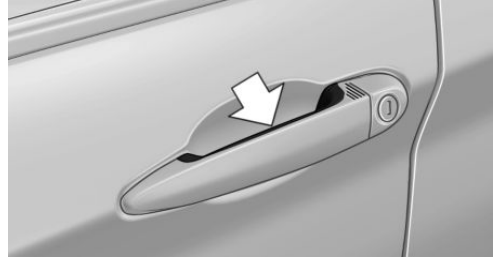

Grasp the door handle on the driver's or front passenger door completely, arrow.

This corresponds with pressing the button on the remote control. 

## Comfort Access

### The concept

The vehicle can be accessed without activating the remote control.

All you need to do is to have the remote control with you, such as in your pants pocket.

The vehicle automatically detects the remote control when it is in close proximity or in the car's interior.

Comfort Access supports the following functions:

- ▶ Unlocking/locking of the vehicle.
- ▶ Unlocking of the trunk lid separately.
- ▶ Start the engine.

### Functional requirements

- ▶ There are no external sources of interference nearby.
- ▶ To lock the vehicle, the remote control must be located outside of the vehicle.
- ▶ The next unlocking and locking cycle is not possible until after approx. 2 seconds.
- ▶ The engine can only be started if the remote control is in the vehicle.

## Locking

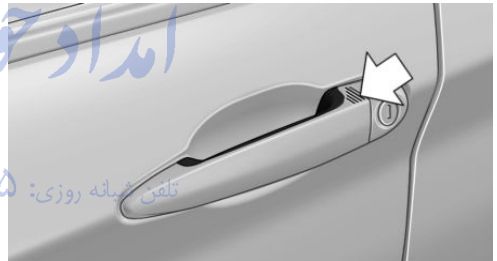

Touch the surface on the door handle of the driver's or front passenger door, arrow, with your finger for approx. 1 second without grasping the door handle.

This corresponds with pressing the button on the remote control. 

To save battery power, ensure that the ignition and all electronic systems and/or power consumers are turned off before locking the vehicle.

## Convenient closing



Monitor closing

Monitor closing to ensure that no one becomes trapped. ◀

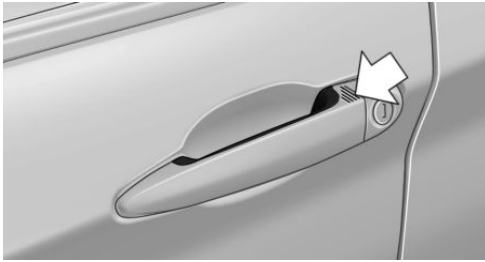

Touch the surface on the door handle of the driver's or front passenger door, arrow, with your finger and hold it there without grasping the door handle.

This corresponds to pressing and holding  the remote control button.

In addition to locking, the exterior mirrors fold in.

### Separately unlocking the trunk lid

Press button on the exterior of the trunk lid.

This corresponds to pressing  the remote control button.

The situation of the doors does not change.

 Do not place the remote control in the cargo area

Take the remote control with you and do not leave it in the cargo area; otherwise, the remote control is locked inside the vehicle when the trunk lid is closed. ◀

### Malfunction

Remote control detection by the vehicle can among others be malfunctioning under the following circumstances:

- ▷ Interference of the radio connection from transmission towers or other equipment with high transmit power.
- ▷ Shielding of the remote control due to metal objects.
- ▷ Interference of the radio connection from mobile phones or other electronic devices in direct proximity.

Do not transport the remote control together with metal objects or electronic devices.

In the case of a malfunction, unlock and lock the vehicle using the buttons of the remote control or using the integrated key, refer to page 39.

## Adjusting

### Unlocking

The settings are saved in the active profile, refer to page 35.

### Doors

1. "Settings"
2. "Doors/key"
3.  Select the symbol.
4. Select the desired function:

- ▷ "Driver's door only"

Only the driver's door and the fuel filler flap are unlocked. Pressing again unlocks the entire vehicle.

- ▷ "All doors"

The entire vehicle is unlocked.

### Trunk lid

Depending on optional features and country version, this setting is not offered in some cases.

1. "Settings"
2. "Doors/key"
3.  Select the symbol.
4. Select the desired function:

- ▷ "Tailgate"

The trunk lid unlocks.

- ▷ "Tailgate + door(s)"

The trunk lid and the doors are unlocked.

## Confirmation signals from the vehicle

The settings are saved in the active profile, refer to page 35.

1. "Settings"
2. "Doors/key"
3. Deactivate or activate the desired confirmation signals.
  - ▷ "Acoustic sig. lock/unlock"
  - ▷ "Flash when lock/unlock"

## Automatic locking

The settings are saved in the active profile, refer to page 35.

1. "Settings"
2. "Doors/key"
3. Select the desired function:
  - ▷ "Lock if no door is opened"
 

The vehicle locks automatically after a short period of time if no door is opened.
  - ▷ "Lock after start driving"
 

The vehicle locks automatically after you drive off.

## Retrieving the seat and mirror settings

The driver's seat and exterior mirror positions used last are stored for the remote control currently in use.

When the vehicle is unlocked, these positions are automatically retrieved if this function was activated.



Pinch hazard when moving back the seat

If this function is used, first make sure that the footwell behind the driver's seat is empty. Otherwise, people might get injured or objects damaged when the seat is moved back. ◀

The adjustment procedure is interrupted:

- ▷ When a seat position reel is pressed.

- ▷ When a button of the seat and mirror memory is pressed.

## Activating the setting

1. "Settings"
2. "Doors/key"
3. "Last seat position autom."

## Alarm system

### The concept

When the vehicle is locked, the vehicle alarm system responds to:

- ▷ Opening a door, the hood or the trunk lid.
- ▷ Movements in the interior.
- ▷ Changes in the vehicle tilt, e. g., during attempts at stealing a wheel or when towing the car.

- ▷ Disconnected battery voltage.

The alarm system briefly signals tampering:

- ▷ By sounding an acoustic alarm.
- ▷ By switching on the hazard warning system.
- ▷ By flashing the daytime running lights.

### Arming and disarming the alarm system

When you unlock or lock the vehicle, either with the remote control or via the Comfort Access, the alarm system is disarmed or armed at the same time.

### Door lock and armed alarm system

The alarm system is triggered when the door is opened, when the vehicle is unlocked via the door lock.

### Panic mode

You can trigger the alarm system if you find yourself in a dangerous situation.



Press button on the remote control for at least 3 seconds.

To reel off the alarm: press any button.

### Indicator lamp on the interior rearview mirror

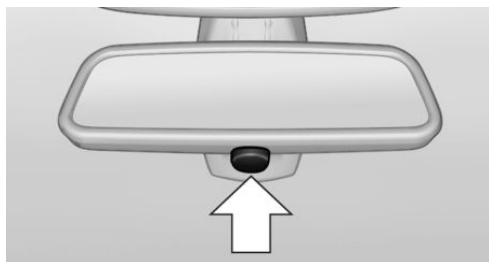

- ▷ The indicator lamp flashes briefly every 2 seconds:  
The system is armed.
- ▷ The indicator lamp flashes after locking:  
The doors, hood or trunk lid is not closed properly, but the rest of the vehicle is secured.  
After 10 seconds, the indicator lamp flashes continuously. Interior motion sensor and tilt alarm sensor are not active.  
When the still open access is closed, interior motion sensor and tilt alarm sensor will be switched on.
- ▷ The indicator lamp goes out after unlocking:  
The vehicle has not been tampered with.
- ▷ The indicator lamp flashes after unlocking until the engine ignition is switched on, but no longer than approx. 5 minutes:  
An alarm has been triggered.

### Tilt alarm sensor

The tilt of the vehicle is monitored.

The alarm system responds in situations such as attempts to steal a wheel or when the car is towed.

### Interior motion sensor

The interior is monitored to the height of the seats. The alarm system is armed together with the interior motion sensor even when the hardtop is open. Falling objects such as leaves can trigger the alarm unintentionally.

### Avoiding unintentional alarms

The tilt alarm sensor and interior motion sensor can be switched off together, such as in the following situations:

- ▷ In automatic car washes.
- ▷ In duplex garages.
- ▷ During transport on trains carrying vehicles, at sea or on a trailer.
- ▷ With animals in the vehicle.

### Switching off the tilt alarm sensor and interior motion sensor



Press the remote control button again within 10 seconds as soon as the vehicle is locked.

The indicator lamp lights up for approx. 2 seconds and then continues to flash.

The tilt alarm sensor and interior motion sensor are turned off, until the vehicle is locked again.



### Switching off the alarm

- ▷ Unlock vehicle with the remote control or reel on the ignition, if needed through emergency detection of remote control, refer to page 35.
- ▷ With Comfort Access: If you are carrying the remote control on your person, grasp the driver side or front passenger side door handle completely.





## Power windows

### General information

-  Take the remote control with you
-  Take the remote control with you when leaving the vehicle so that children, e.g., cannot operate the power windows and injure themselves. ◀





### Opening individually



- ▶  Press the button to the resistance point.  
The window opens while the reel is held.
- ▶  Press the reel beyond the resistance point.  
The window opens automatically. Pressing the reel again stops the motion.



See also: Convenient opening, refer to page 37, via remote control.

### Opening together

- ▶  Press the button to the resistance point.  
All windows open while the reel is being held.
- ▶  Press the reel beyond the resistance point.  
All windows open automatically.  
Pressing again stops the motion.



### Closing individually

-  Keep the closing path clear
-  Monitor closing and make sure that the closing path of the window is clear; otherwise, injuries may result. ◀

- ▶  Pull the reel to the resistance point.  
The window closes while the reel is held.
- ▶  Pull the reel beyond the resistance point.  
The window closes automatically. Pulling again stops the motion.

See also: Convenient closing, refer to page 37, via remote control.



### Closing together

- ▶  Pull the reel to the resistance point.  
All windows are closed while the reel is being held.
- ▶  Pull the reel beyond the resistance point.  
All windows are automatically closed.  
Pressing the reel stops the motion.

### Pinch protection system

-  Danger of jamming even with pinch protection

Even with the pinch protection system, check that the window's closing path is clear; otherwise, the closing action may not stop in certain situations, e.g., if thin objects are present. ◀

-  No window accessories
-  Do not install any accessories in the window's range of movement; otherwise, the pinch protection system will be impaired. ◀

If closing force exceeds a specific margin as a window closes, closing is interrupted.

The window reopens slightly.

## Closing without the pinch protection system

-  Keep the closing path clear  
Monitor closing and make sure that the closing path of the window is clear; otherwise, injuries may result. ◀

E.g. danger from the outside or ice might prevent window from closing properly - proceed as follows:

1. Pull the reel past the resistance point and hold it there.  
The pinch protection is limited and the window reopens slightly if the closing force exceeds a certain margin.
2. Pull the reel past the resistance point again within approx. 4 seconds and hold it there.  
The window closes without jam protection.

## Hardtop

### General information

The hardtop can be opened and closed at walking speed.

If the vehicle is accelerated while the hardtop is in motion, the movement is stopped.

### Hints

- ▷ If the hardtop is not completely opened or closed, the trunk lid cannot be opened since it would bump against the hardtop.
- ▷ If possible, close the hardtop when the vehicle is parked. A closed hardtop protects car from weather-related damage and against theft.
- ▷ It is not possible to start the engine and operate the hardtop simultaneously. When the engine is started using the Start/Stop button or using the Auto Start/Stop function, the hardtop movement is briefly interrupted.

## At a glance



Hardtop buttons

## Functional requirements

The ignition or radio-ready state must be switched on.

The following requirements must be fulfilled in order to be able to move the hardtop.

- ▷ The cargo area partition is flipped down.
- ▷ The loading aid, refer to page 159, is shut down.
- ▷ The trunk lid is closed.
- ▷ The external temperature is above 14 °F/-10 °C.
- ▷ The voltage of the vehicle electrical system is sufficient.
- ▷ The hardtop drive is not overheating.
- ▷ The vehicle speed is not too high.
- ▷ The lateral tilt of the vehicle is not too great.
- ▷ The windows can be lowered.

If this requirement is not met, a check control message is displayed.

## Safety information



- Note the swivel range of the hardtop  
The hardtop pivots back and up during opening and closing. When the hardtop is moved, e.g., in garages, make sure that the space at the top is at least 79 inches/2 meters and the space at the rear is at least 20 in-

ches/50 centimeters; otherwise, damages may result. ◀

**!** Do not place objects on the hardtop  
Do not place any objects on the hardtop, otherwise, they could fall and cause damage or injuries. ◀

**!** No hardtop movement when rollover protection is activated

Do not move the hardtop when rollover protection is activated; otherwise, it may result in damage to the hardtop. ◀

**!** Open and close hardtop completely  
Always open or close the hardtop completely. Hardtop and hardtop well storage cover are locked in the final positions. Driving with the hardtop or hardtop well storage cover unlocked can result in damage. ◀

**!** Do not reach into the hardtop mechanism

Do not reach into the hardtop mechanism during the opening and closing operation. Keep children away from the opening path of the hardtop, otherwise, there is a risk of injury. ◀

**!** Observe traffic during operation  
When the hardtop is opened while driving, be alert to traffic; otherwise, it may result in an accident. If possible, do not move the hardtop while driving in reverse because rearward vision is severely impaired while the hardtop is in motion. During windy conditions, do not operate the hardtop while driving. ◀

**!** Do not attach any roof carrier systems to the hardtop

Do not attach any roof carrier systems; otherwise, an accident may occur. ◀

**!** Do not move the hardtop with the bicycle racks mounted

Do not open or close the hardtop with the bicycle rack mounted on the trailer hitch; otherwise

damage to trunk lid and bicycle rack may occur. ◀

**!** Do not operate hardtop on uneven sections or road

Do not open or close hardtop on uneven sections of road. Otherwise, the vibrations can result in damage to the hardtop. ◀

## Using the cargo area

### When hardtop is open



Luggage can only be stored under the cargo area partition; note the respective label.

### When hardtop is closed



Luggage can be stowed under the cargo area partition and to the left and right of the lifting mechanism; note the respective label.

**!** Remove articles of luggage from the side areas

Before opening the hardtop, remove all pieces of luggage from the side areas. Otherwise, luggage and hardtop can be damaged. ◀



## Before opening and closing

- ▷ Follow the safety instructions for the hardtop.
- ▷ Make sure that the cargo area partition in the cargo area is folded down.
- ▷ Make sure that the cargo does not push against the cargo area partition from below.
- ▷ Make sure that the trunk lid is closed.

## Opening and closing from the inside

In order to protect the battery, move the hardtop only when the engine is running if possible.

Before closing the hardtop, remove any foreign objects from the windshield frame; otherwise, closing may be prevented.

- ▷  Press and hold the reel. The windows are rolled down, and the hardtop opens as long as the reel is pressed.
- ▷  Pull the reel and hold it. The windows are lowered, the hardtop closes and the windows are raised again as long as the reel is pulled.

Push or pull reel until the hardtop is completely open or closed and the end of the procedure is indicated by a corresponding Check Control message. Always make sure that the hardtop well storage cover is completely closed. If the hardtop is completely open or closed, hardtop and hardtop well storage cover are latched.

## Interruption

-  Open and close hardtop completely  
Always open or close the hardtop completely. Hardtop and hardtop well storage cover are locked in the final positions. Driving with the hardtop or hardtop well storage cover unlocked can result in damage.◀

The hardtop movement is interrupted if the reel is released. The sequence can be continued in the desired direction using the reel.

## Convenient operation from outside

When equipped with Comfort Access, the hardtop can also be operated from outside.

- ▷ Convenient opening with remote operation, refer to page 37.
- ▷ Convenient closing with the remote control, refer to page 37.

## Cargo area partition

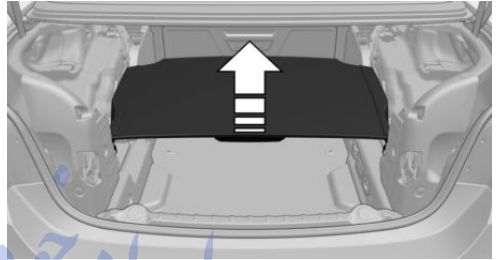

Fold down cargo area partition in the back so that the hardtop can be opened.

Fold down cargo area partition in the front in order to enlarge the cargo area lidacity when the hardtop is closed.

## Wind deflector

### The concept

The wind deflector reduces the air movement in the vehicle interior when driving with the hardtop down.

## At a glance

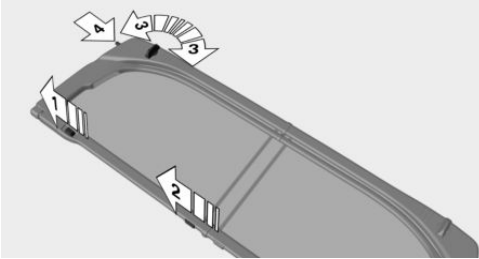

- ▶ The control elements, arrows 1 to 3, are present on both sides, so that the wind deflector can be installed and removed from both sides of the vehicle.
- ▶ If the wind deflector is fully extended, it is then secured.

Before retracting the release slide, arrow 1, or release slide, arrow 2, pull outward to unfasten the lock.

- ▶ When installed, the wind deflector can be folded forward in order to place luggage on the rear seat, e.g. With the release lever, arrow 3, the pins, arrow 4, can be retracted on both sides in order to fold the wind deflector forward.

## Installation

1. Unlock the rear seat backrest, arrow 1, and fold forward, arrow 2.

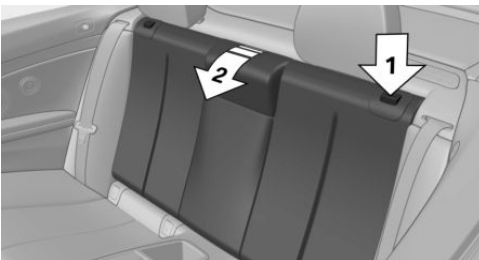

2. Push transport lock, arrow up. Remove wind deflector.

Fold the rear seat backrest rearward.

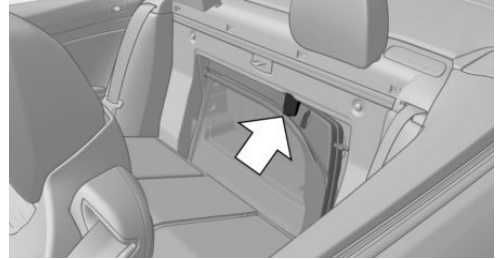

3. Fully extend the wind deflector and lock it.

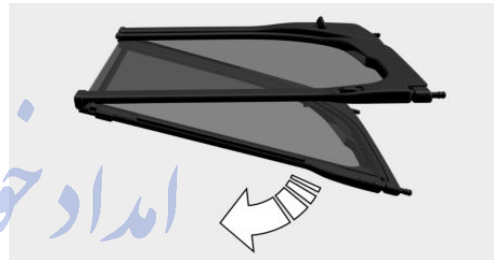

4. Insert wind deflector from one side of the vehicle with the pins in the corresponding fixtures on the opposite side of the vehicle.

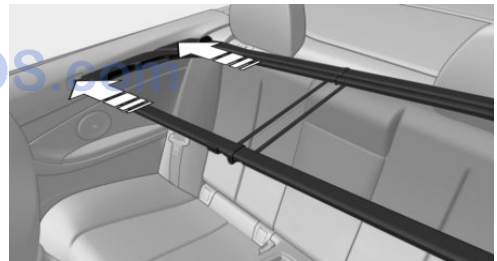

5. Pull the release slide, arrow 1, and press the wind deflector inwardly, arrow 2, to the extent that the wind deflector can be positioned in front of the mounts on the installation side.

Press the wind deflector downward until it locks, while inserting the pins in the corresponding mounts, arrow 3.

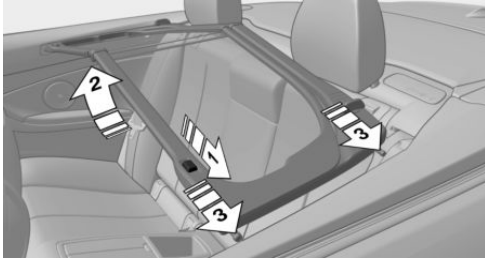

6. Grasp the inner framework of the wind deflector on the recessed grip and fold it up.

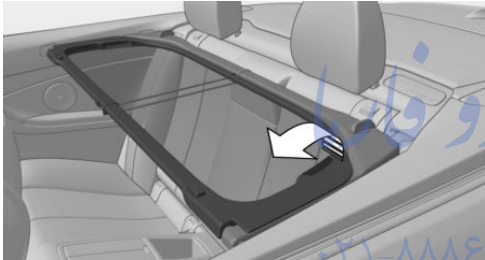

**!** Do not tilt the front seat backrest too far back

Do not tilt the front seat backrest too far back with the wind deflector installed if the seat is to be moved all the way back. Otherwise, the wind deflector will be damaged. ◀

### Removing

Proceed in reverse sequence.

Disengage the lock before retracting.

1. On vehicles with a through-loading system: fold rear transport locks down, arrow 1.

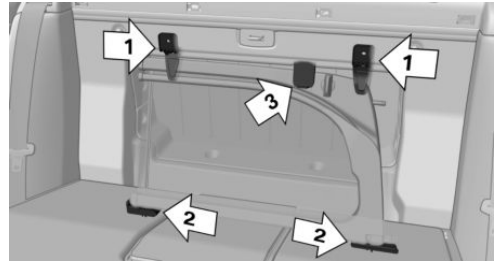

2. Place wind deflector in the orientation shown in the picture on the lower fixtures, arrow 2, and tilt it back.
3. Push the front transport lock down, arrow 3.

### Luggage on the back seat

In order to store luggage on the rear seat when the wind deflector is installed, the outer frame of the wind deflector is flipped up.

1. Turn the release lever 90 ° counterclockwise, arrow 1, and fold the outer frame forward, arrow 2.

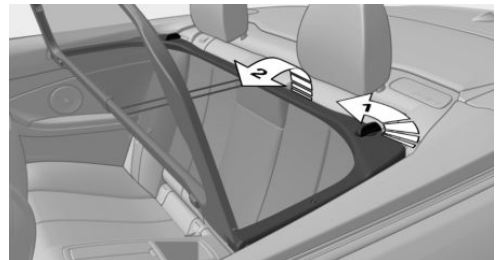

2. Place luggage on the rear seat. Make sure that the luggage does not project past the fixing points for the wind deflector.
3. Fold wind deflector back and align it with the fixture on the opposite side of the vehicle.

- Turn release lever clockwise by 45 ° in order to extend the opposing pin.
4. Align wind deflector with the installation side for mounting and turn release lever another 45 ° in order to extend the second pin.

امداد خودرو فارما

تلفن شبانه روزی: ۰۲۱-۸۸۸۶۲۰۸۵

FarmaSOS.com

# Adjusting

## Vehicle features and options

This chapter describes all standard, country-specific and optional features offered with the series. It also describes features that are not necessarily available in your car, e. g., due to the selected options or country versions. This also applies to safety-related functions and systems.

## Sitting safely

The ideal seating position can make a vital contribution to relaxed, fatigue-free driving.

The seating position plays an important role in an accident in combination with:

- ▷ Safety belts, refer to page 55.
- ▷ Head restraints, refer to page 56.
- ▷ Airbags, refer to page 96.

## Seats

### Hints

 Do not adjust the seat while driving  
Do not adjust the driver's seat while driving, or the seat could respond with unexpected movement and the ensuing loss of vehicle control could lead to an accident. ◀

 Do not incline the backrest too far to the rear

Also on the front passenger side, do not incline the backrest on the front passenger side too far to the rear while driving, or there is a risk of slipping under the safety belt in the event of an accident. This would eliminate the protection normally provided by the belt. ◀



Keep the movement area unobstructed  
When changing the seat position, keep the seat's area of movement unobstructed; otherwise, people might get injured or objects damaged. ◀

## Electrically adjustable seats

### At a glance

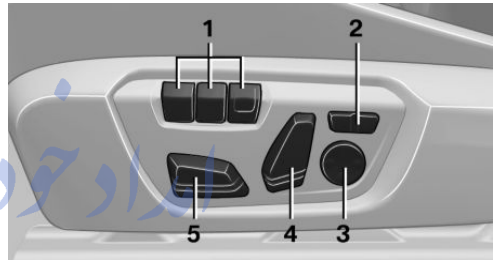

- 1 Seat and mirror memory
- 2 Backrest width
- 3 Lumbar support
- 4 Backrest tilt
- 5 Forward/backward, height, seat tilt

## General information

The seat setting for the driver's seat is stored for the profile currently in use. When the vehicle is unlocked via the remote control, the position is automatically retrieved if the Function, refer to page 43, is activated for this purpose.



## Adjustments in detail

### 1. Forward/back.

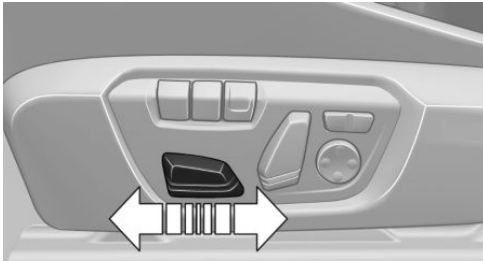

### 2. Height.

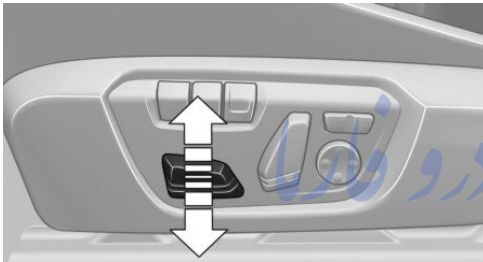

### 3. Seat tilt.

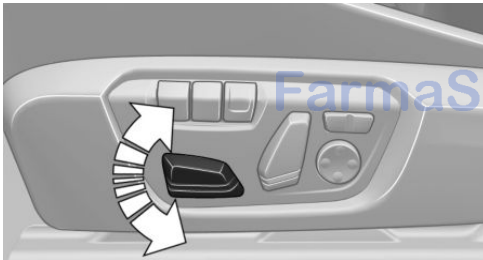

### 4. Backrest tilt.

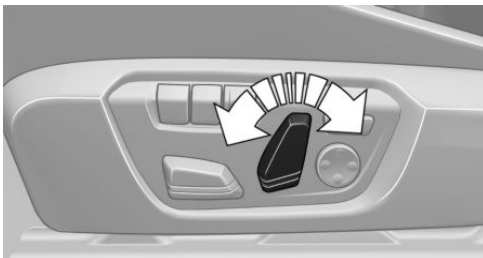

## Thigh support

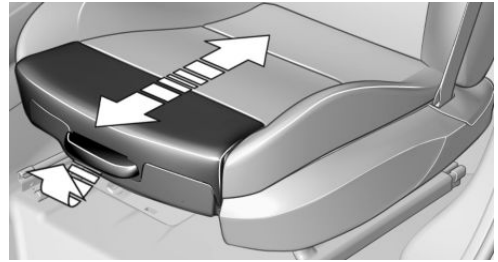

Pull the lever at the front of the seat and adjust the thigh support.

## Lumbar support

The curvature of the seat backrest can be adjusted in a way that it supports the lumbar region of the spine. The lower back and the spine are supported for upright posture.



► Press the front/rear section of the reel.

The curvature is increased/decreased.

► Press the upper/lower section of the reel.

The curvature is shifted up/down.

## Backrest width



Change the width of the backrest using the side wings to adjust the lateral support.

## Front seat heating



### Switching on



Press button once for each temperature level.

The maximum temperature is reached when three LEDs are lit.

If the journey is continued within approx. 15 minutes, the seat heating is activated automatically with the temperature selected last.

When ECO PRO, refer to page 175, is activated, the heater output is reduced.

### Switch off



Press button longer.  
The LEDs go out.

## Neck warmer

### The concept

The neck warmer ensures just the right temperature for the neck area via supply of warm air.

### Hints



Do not cover the neck warmer

Do not cover the neck warmer, e.g., with protective covers; otherwise, its operation could be impaired and result in damage. ◀



Adapt the supply of air accordingly

Hot air can flow out of the vents of the neck warmer in close proximity. Adapt the air feed as needed; otherwise, high temperatures can result in injuries or property damage. ◀

### At a glance



### Switching on



Press button once for each level.

The maximum temperature and fan output is reached when three LEDs are lit.

### Switch off



Press button longer.  
The LEDs go out.

## Entering the rear

### Note



Keep the movement area unobstructed

When changing the seat position, keep the seat's area of movement unobstructed; otherwise, people might get injured or objects damaged. ◀



Folding back and locking the backrest

Before driving off, fold back and lock the backrests; otherwise, an unexpected seat movement may cause an accident. ◀

تلفن شباتون: +۹۰ ۲۱ ۸۸۶۲۰۸۸

FarmaSOS.com

## Unlocking the backrest

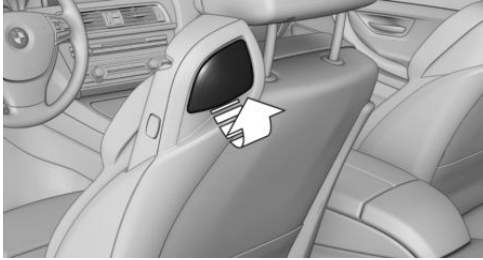

1. Pull lever up to the stop.
2. Fold backrest forward.

## Changing the seat position

### Requirements

- ▷ Vehicle at a standstill.
- ▷ When the door is open, the seat is accessible from the side on which the door is open.

### Controls

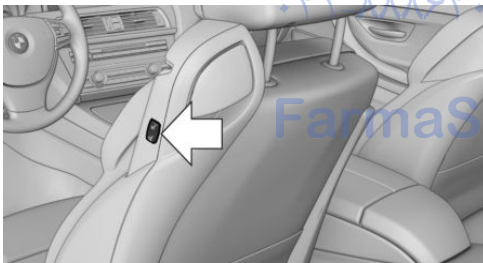

- ▷ Press and hold this button until the seat has moved to the desired position. Releasing the button stops window/roof movement.
- ▷ Press button briefly. The seat automatically moves to the respective end position. Pressing again stops the motion.

## Folding back and locking the backrest

After entering the rear, fold the backrest back and lock it.



Press button. The seat moves to its original position. Pressing again stops the motion.

## Safety belts

### Seats with safety belt

The vehicle has four seats, each of which is equipped with a safety belt.

### Number of safety belts

Your vehicle has been fitted with four safety belts for your and your passengers' safety. However, they can only offer protection when adjusted correctly.

### General information

Always make sure that safety belts are being worn by all occupants before driving off.

For the occupants' safety the belt locking mechanism triggers early. Slowly guide the belt out of the holder when applying it.

Although airbags enhance safety by providing added protection, they are not a substitute for safety belts.

The upper shoulder strap's anchorage point will be correct for adult seat occupants of every build if the seat is correctly adjusted.

### Hints



One person per safety belt

Never allow more than one person to wear a single safety belt. Never allow infants or small children to ride on a passenger's lap. ◀



Putting on the belt

Lay the belt, without twisting, snugly across the lap and shoulders, as close to the body as possible. Make sure that the belt lies low around the hips in the lap area and does not press on the abdomen. Otherwise, the belt

can slip over the hips in a frontal impact and injure the abdomen.

The safety belt must not lie across the neck, rub on sharp edges, be routed over breakable objects, or be pinched. ◀

 What reduces the restraining effect

Avoid wearing bulky clothing, and pull the shoulder belt periodically to readjust the tension. Make sure that the belt is not jammed; otherwise, the belt can be damaged and the restraining effect is reduced. ◀

## Buckling the belt

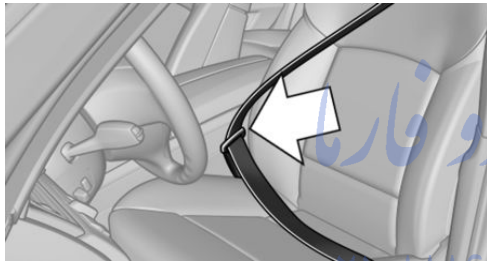

Make sure you hear the latch plate engage in the belt buckle.

## Unbuckling the belt

1. Hold the belt firmly.
2. Press the red button in the belt buckle.
3. Guide the belt back into its roll-up mechanism.

## Safety belt reminder for driver's and passenger's seat

 The indicator lamp lights up and a signal sounds. Make sure that the safety belts are positioned correctly. The safety belt reminder is active at speeds above approx. 6 mph/10 km/h. It can also be activated if objects are placed on the front passenger seat.

## Damage to safety belts

Wear and tear after accidents or when damaged otherwise:

Have the safety belts, including the safety belt tensioners, replaced and have the belt anchors checked.

 Check and replace safety belts

This should only be done by your service center; otherwise, this safety feature might not work properly. ◀

## Front headrests

### Correctly adjusted head restraint

A correctly adjusted head restraint reduces the risk of injury to cervical vertebrae in the event of an accident.

 Adjusting the head restraint

Adjust the head restraints of all occupied seats properly; otherwise, there is an increased risk of injury in an accident. ◀

### Height

Adjust the head restraint so that its center is approximately at ear level.

### Distance

Adjust the distance so that the head restraint is as close as possible to the back of the head.

If necessary, adjust the distance by adjusting the tilt of the backrest.

## Adjusting the height

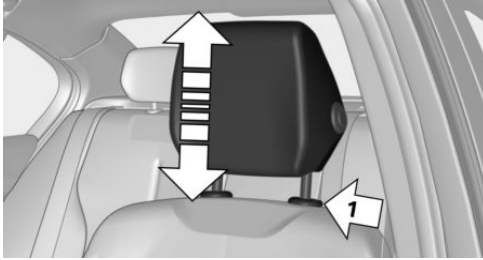

- ▷ To raise: push.
- ▷ To lower: press button, arrow 1, and push headrest down.

## Distance to the back of the head



- ▷ Forward: pull.
- ▷ Back: press the button and push the head restraint toward the rear.

## Seat and mirror memory

### Hints

 Do not retrieve the memory while driving  
Do not retrieve the memory setting while driving, as an unexpected movement of the seat could result in an accident. ◀

 Keep the movement area unobstructed  
When changing the seat position, keep the seat's area of movement unobstructed; otherwise, people might get injured or objects damaged. ◀

## The concept

Two driver's seat and exterior mirror positions can be stored per profile, refer to page 35, and called up. Settings for the backrest width and lumbar support are not stored in memory.

## At a glance



## Storing

1. Switch on the ignition.
2. Set the desired position.
3.  Press button. The LED in the button lights up.
4. Press selected button 1 or 2 while the LED is lit. The LED goes out.

If the SET button is pressed accidentally:

-  Press button again.  
The LED goes out.

## Calling up settings

### Comfort function

1. Open the driver's door.
2. Switch off the ignition.
3. Briefly press the desired button 1 or 2.

The corresponding seat position is performed automatically.

The procedure stops when a reel for adjusting the seat or one of the buttons is pressed.

## Safety mode

1. Close the driver's door or reel on the ignition.
2. Press and hold the desired button 1 or 2 until the adjustment procedure is completed.

## Calling up of a seat position deactivated

After a brief period, calling up stored seat positions is deactivated to save battery power.

To reactivate calling up of a seat position:

- ▷ Open and close the door or trunk lid.
- ▷ Press a button on the remote control.
- ▷ Press the Start/Stop button.

## Mirrors

### Exterior mirrors

#### General information

The mirror on the passenger side is more curved than the driver's side mirror.

Depending on the vehicle equipment, the mirror setting is stored for the profile currently in use. When the vehicle is unlocked via the remote control, the position is automatically retrieved if this function is active.

#### Note



Estimating distances correctly

Objects reflected in the mirror are closer than they appear. Do not estimate the distance to the traffic behind you based on what you see in the mirror, as this will increase your risk of an accident. ◀

## At a glance



- 1 Adjusting 58
- 2 Left/right, Automatic Curb Monitor
- 3 Fold in and out 59

## Selecting a mirror



To change over to the other mirror:  
Slide the switch.

## Adjusting electrically



The setting corresponds to the direction in which the button is pressed.

## Saving positions

Seat and mirror memory, refer to page 57.

## Adjusting manually

In case of electrical malfunction press edges of mirror.

## Automatic Curb Monitor

### The concept

If reverse gear is engaged, the mirror glass on the front passenger side is tilted downward. This improves your view of the curb and other low-lying obstacles when parking, e.g.

### Activating



1. Slide the switch to the driver's side mirror position.

2. Engage selector lever position R.

### Deactivating

Slide the switch to the passenger side mirror position.

### Fold in and out

 Press button.

Possible at speeds up to approx. 15 mph/20 km/h.

E. g. this is advantageous

- ▷ In car washes.
- ▷ In narrow streets.
- ▷ For folding mirrors back out that were folded away manually.

Mirrors that were folded in are folded out automatically at a speed of approx. 25 mph/40 km/h.

 Fold in the mirror in a car wash

Before washing the car in an automatic car wash, fold in the exterior mirrors by hand or with the button; otherwise, the mirrors could be damaged, depending on the width of the vehicle. ◀

### Automatic heating

Both exterior mirrors are automatically heated whenever the engine is running.

### Automatic dimming feature

Both exterior mirrors are automatically dimmed. Photocells are used to control the Interior rearview mirror, refer to page 59.

### Interior rearview mirror, manually dimmable

#### Turn knob

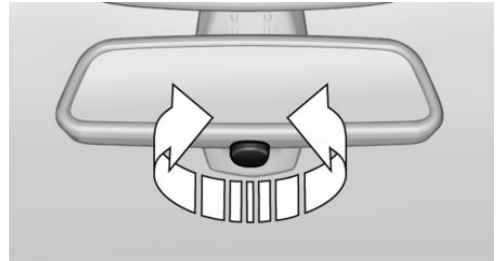

Turn the knob to reduce the blinding effect by the interior mirror.

### Interior rearview mirror, automatic dimming feature

#### The concept

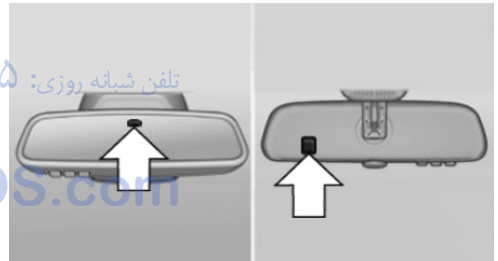

Photocells are used for control:

- ▷ In the mirror glass.
- ▷ On the back of the mirror.

### Functional requirement

For proper operation:

- ▷ Keep the photocells clean.
- ▷ Do not cover the area between the inside rearview mirror and the windshield.

## Steering wheel

### Note



Do not adjust while driving

Do not adjust the steering wheel while driving; otherwise, an unexpected movement could result in an accident. ◀

### Adjusting

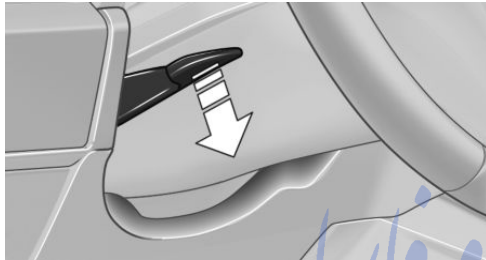

1. Fold the lever down.
2. Move the steering wheel to the preferred height and angle to suit your seating position.
3. Fold the lever back.

### Steering wheel heating



Press button.

- ▷ On: the LED lights up.
- ▷ Off: the LED goes out.

امداد خودرو فارما

تلفن شبانه روزی: ۰۲۱-۸۸۸۶۲۰۸۵

FarmaSOS.com



# Transporting children safely

## Vehicle features and options

This chapter describes all standard, country-specific and optional features offered with the series. It also describes features that are not

necessarily available in your car, e. g., due to the selected options or country versions. This also applies to safety-related functions and systems.

## The right place for children

### Note

 Children in the vehicle  
Do not leave children unattended in the vehicle; otherwise, they could endanger themselves and other persons, e.g., by opening the doors. ◀

### Children should always be in the rear

Accident research shows that the safest place for children is in the back seat.

 Transporting children in the rear  
Only transport children younger than 13 years of age or shorter than 5 ft/150 cm in the rear in child restraint systems provided in accordance with the age, weight and size of the child; otherwise, there is an increased risk of injury in an accident.

Children 13 years of age or older must wear a safety belt as soon as a suitable child restraint system can no longer be used due to their age, weight and size. ◀

### Children on the front passenger seat

Should it ever be necessary to use a child restraint system in the front passenger seat, make sure that the front, knee and side airbags on the front passenger side are deactivated. Automatic deactivation of front-seat passenger airbags, refer to page 98.

### Note

 Deactivating the front-seat passenger airbags

If a child restraint system is used in the front passenger seat, deactivate the front-seat passenger airbags; otherwise, there is an increased risk of injury to the child when the airbags are activated, even with a child restraint system. ◀

## Installing child restraint systems

### Hints

 Manufacturer's information for child restraint systems

To select, mount and use child restraint systems, observe the information provided by the system manufacturer; otherwise, the protective effect can be lost. ◀

 Ensuring the stability of the child seat  
When installing child restraint systems, make sure that the child seat is securely fastened to the backrest of the seat. Angle and headrest of the backrest might need to be adjusted or possibly be removed. Make sure that all backrests are securely locked. Otherwise the stability of the child seat can be affected, and there is an increased risk of injury because

of unexpected movement of the rear seat backrest. ◀

## On the front passenger seat

### Deactivating airbags

 Deactivating the front-seat passenger airbags

If a child restraint system is used in the front passenger seat, deactivate the front-seat passenger airbags; otherwise, there is an increased risk of injury to the child when the airbags are activated, even with a child restraint system. ◀

After installing a child restraint system in the front passenger seat, make sure that the front, knee and side airbags on the front passenger side are deactivated.

Deactivate the front-seat passenger airbags automatically, refer to page 98.

### Seat position and height

Before installing a child restraint system, move the front passenger seat as far back as possible and adjust its height to the highest and thus best possible position for the belt and to offer optimal protection in the event of an accident.

If the upper anchorage of the safety belt is located in front of the belt guide of the child seat, move the passenger seat carefully forward until the best possible belt guide position is reached.

### Backrest width

 Backrest width for the child seat

Before installing a child restraint system in the front passenger seat, the backrest width must be opened completely. Do not change

the adjustment after this; otherwise, the stability of the child seat will be reduced. ◀

Adjustable backrest width: before installing a child restraint system in the front passenger seat, open the backrest width completely. Do not change the backrest width again and do not call up a memory position.

### Child seat security



The rear safety belts and the front passenger safety belt can be permanently locked to fasten child restraint systems.

### Locking the safety belt

1. Pull out the strap completely.
2. Secure the child restraint system with the belt.
3. Allow the strap to be pulled in and pull it tight against the child restraint system. The safety belt is locked.

### Unlocking the safety belt

1. Unbuckle the belt buckle.
2. Remove the child restraint system.
3. Allow the strap to be pulled in completely.

## LATCH child restraint system

LATCH: Lower Anchors and Tether for Children.

### Note

 Follow manufacturer's information for LATCH child restraint systems

To mount and use the LATCH child restraint systems, observe the operating and safety information from the system manufacturer; otherwise, the level of protection may be reduced. ◀

### Mounts for the lower LATCH anchors

The lower anchors may be used to attach the CRS to the vehicle seat up to a combined child and CRS weight of 65 lb/30 kg when the child is restrained by the internal harnesses.

 Properly engage the lower LATCH anchors

Make sure that the lower LATCH anchors have properly engaged and that the child restraint system is resting snugly against the backrest; otherwise, the degree of protection may be reduced. ◀

Before mounting the LATCH child restraint system, pull the belt away from the child restraint system.



The corresponding symbol shows the mounts for the lower LATCH anchors.



### Position

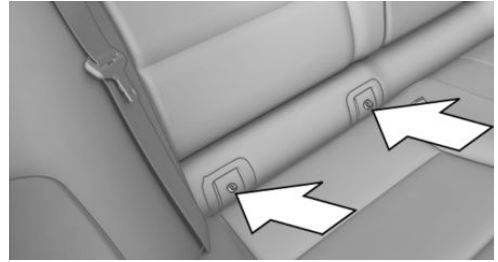

Attach to the lower LATCH anchors located behind the indicated covers.

### Assembly of LATCH child restraint systems

1. Mount the child restraint system; refer to the user's manual of the system.
2. Ensure that both LATCH anchors are properly connected.

### Child restraint fixing system with a tether strap

#### For Canadian customers Only

The following statement is required by Transport Canada:

This vehicle is not equipped with user-ready tether anchorages. As such neither a child restraint system, nor a booster cushion, requiring the use of a tether strap can be properly secured in the vehicle.

# Driving

## Vehicle features and options

This chapter describes all standard, country-specific and optional features offered with the series. It also describes features that are not necessarily available in your car, e. g., due to the selected options or country versions. This also applies to safety-related functions and systems.

## Start/Stop button

### The concept



Pressing the Start/Stop button switches the ignition on or off and starts the engine.

Steptronic transmission: The engine starts if the brakes are stepped on while pressing the Start/Stop button.

### Ignition on

Steptronic transmission: Press the Start/Stop button without stepping on the brake.

All vehicle systems are ready for operation.

Most of the indicator and warning lights in the instrument cluster light up for a varied length of time.

To save battery power when the engine is off, reel off the ignition and any unnecessary electronic systems/power consumers.

### Note

If the engine is switched off and the ignition is switched on, the system automatically switches to the radio-ready state if the lights are turned off or, if correspondingly equipped, the daytime running lights are activated.

## Ignition off

Steptronic transmission: Press the Start/Stop button again without stepping on the brake.

All indicator lights in the instrument cluster go out.

To save battery power when the engine is off, reel off the ignition and any unnecessary electronic systems/power consumers.



P when the ignition is switched off

P is engaged automatically when the ignition is switched off. When in an automatic car wash, e.g., ensure that the ignition is not switched off accidentally. ◀

The ignition automatically cuts off while the vehicle is stationary and the engine is stopped:

- ▶ When locking the vehicle, and when the low beams are activated.
- ▶ Shortly before the battery is discharged completely, so that the engine can still be started. This function is only available when the low beams are turned off.
- ▶ When opening or closing the driver door, if the driver's safety belt is unbuckled and the low beams are turned off.
- ▶ While the driver's safety belt is unbuckled with driver's door open and low beams off.

The low beams reel to parking lights after approx. 15 minutes of no use.

## Radio ready state

Activate radio-ready state:

- ▶ When the engine is running: press the Start/Stop button.

Some electronic systems/power consumers remain ready for operation.

The radio-ready state switches off automatically:

- ▶ After approx. 8 minutes.

- ▶ When the vehicle is locked using the central locking system.
- ▶ Shortly before the battery is discharged completely, so that the engine can still be started.

The radio-ready state remains active if, e.g., the ignition is automatically switched off for the following reasons:

- ▶ Opening or closing the driver's door.
- ▶ Unfastening of the driver's safety belt.
- ▶ When automatically switching from low beams to parking lights.

## Starting the engine

### Hints



#### Enclosed areas

Do not let the engine run in enclosed areas, since breathing in exhaust fumes may lead to loss of consciousness and death. The exhaust gases contain carbon monoxide, an odorless and colorless but highly toxic gas. ◀



#### Unattended vehicle

Do not leave the vehicle unattended with the engine running; doing so poses a risk of danger.

Before leaving the vehicle with the engine running, set the parking brake and place the transmission in selector lever position P or N to prevent the vehicle from moving. ◀



#### Repeated starting in quick succession

Avoid trying to start the vehicle repeatedly and in quick succession. Otherwise, the fuel is not burned or is inadequately burned, posing a risk of overheating and damage to the catalytic converter. ◀

Do not wait for the engine to warm-up while the vehicle remains stationary. Start driving at moderate engine speeds.

## Steptronic transmission

### Starting the engine

1. Depress the brake pedal.
2. Press the Start/Stop button.

The ignition is activated automatically for a certain time and is stopped as soon as the engine starts.

## Engine stop

### Hints



Take the remote control with you

Take the remote control with you when leaving the vehicle so that children, e.g., cannot start the engine. ◀



Apply parking brake and further secure the vehicle if needed.

Set the parking brake firmly when parking; otherwise, the vehicle could roll. On steep upward and downward inclines, further secure the vehicle, e.g., by turning the steering wheel in the direction of the curb. ◀

### Before driving into a car wash

So that the vehicle can roll into a car wash observe instructions for going into an automatic car wash, refer to page 220.

## Steptronic transmission

### Switching off the engine

1. Engage selector lever position P with the vehicle stopped.
2. Press the Start/Stop button.  
The engine is switched off.  
The radio-ready state is switched on.
3. Set the parking brake.

## Auto Start/Stop function

### The concept

The Auto Start/Stop function helps save fuel. The system switches off the engine during a stop, e.g., in traffic congestion or at traffic lights. The ignition remains switched on. The engine starts again automatically for driving off.

### Automatic mode

After every start of the engine using the Start/Stop button, the Auto Start/Stop function is in the last selected state, refer to page 67.

When the Auto Start Stop function is active, it is available when the vehicle is traveling faster than about 3 mph, approx. 5 km/h.

### Engine stop

The engine is switched off automatically during a stop under the following conditions:

Steptronic transmission:

- ▷ The selector lever is in selector lever position D.
- ▷ Brake pedal remains depressed while the vehicle is stopped.
- ▷ The driver's safety belt is buckled or the driver's door is closed.

The air flow from the air conditioner is reduced when the engine is switched off.

### Displays in the instrument cluster

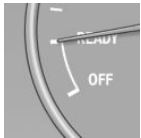

The READY display in the tachometer signals that the Auto Start/Stop function is ready to start the engine automatically.



The display indicates that the conditions for an automatic engine stop have not been met.

### Note

The engine is not switched off automatically in the following situations:

- ▷ External temperature too low.
- ▷ The external temperature is high and automatic climate control is running.
- ▷ The car's interior has not yet been heated or cooled to the required level.
- ▷ The engine is not yet at operating temperature.
- ▷ The wheels are at a sharp angle or the steering wheel is being turned.
- ▷ After driving in reverse.
- ▷ Fogging of the windows when the automatic climate control is switched on.
- ▷ Vehicle battery is heavily discharged.
- ▷ At higher elevations.
- ▷ The engine compartment lid is unlocked.
- ▷ The parking assistant is activated.
- ▷ Neck warmer is activated.
- ▷ Stop-and-go traffic.
- ▷ The selector lever is in position N, M/S or R.
- ▷ Use of fuel with high ethanol content.

### Starting the engine

The engine starts automatically under the following conditions:

- ▷ Steptronic transmission:  
By releasing the brake pedal.

After the engine starts, accelerate as usual.

### Safety mode

After the engine switches off automatically, it will not start again automatically if any one of the following conditions are met.

- ▷ The driver's safety belt is unbuckled and the driver's door is open.
- ▷ The hood was unlocked.

Some indicator lights light up for a varied length of time.

The engine can only be started via the Start/Stop button.

### Note

Even if driving off was not intended, the deactivated engine starts up automatically in the following situations:

- ▶ Excessive warming of the car's interior when the cooling function is switched on.
- ▶ The steering wheel is turned.
- ▶ Steptronic transmission: change from selector lever position D to R, N or M/S.
- ▶ Steptronic transmission: change from selector lever position P to N, D, R or M/S.
- ▶ Fogging of the windows when the automatic climate control is switched on.
- ▶ Vehicle battery is heavily discharged.
- ▶ Excessive cooling of the car's interior when the heating is switched on.

## Activating/deactivating the system manually

### Using the button



Press button.

- ▶ LED comes on: Auto Start/Stop function is deactivated.

The engine is started during an automatic engine stop.

The engine can only be stopped or started via the Start/Stop button.

- ▶ LED goes out: Auto Start/Stop function is activated.

## Switching off the vehicle during an automatic engine stop

During an automatic engine stop, the vehicle can be switched off permanently, e.g., when leaving it.

1. Press the Start/Stop button. The ignition is switched off. The Auto Start/Stop function is deactivated.

Selector lever position P is engaged automatically.

2. Set the parking brake.

Engine start as usual via Start/Stop button.

## Automatic deactivation

In certain situations, Auto Start/Stop function is deactivated automatically for safety reasons as if the driver were absent.

## Malfunction

The Auto Start/Stop function no longer switches off the engine automatically. A Check Control message is displayed. It is possible to continue driving. Have the system checked.

## Parking brake

### Applying

The lever automatically engages after being pulled up.



The indicator lamp lights up red. The parking brake is set.



Lower lamp: indicator lamp in Canadian models

## Releasing

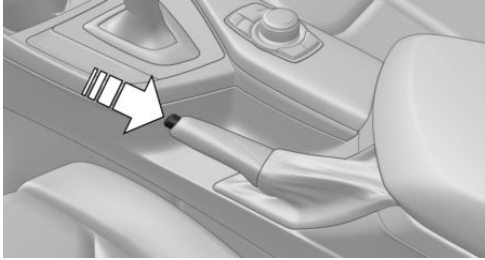

Raise lever slightly, press the button and guide the lever down.

## Hints



Use while driving

On rare occasions if it is necessary to use the parking brake while driving, do not use excessive force when applying it. When using it, keep the button on the lever depressed.

Otherwise, using excessive force when applying the parking brake may cause the rear wheels to lock, resulting in fishtailing. ◀

To prevent corrosion and one-sided brake action, lightly apply the parking brake periodically while coasting, if traffic conditions permit.

The brake lights will not light up if the parking brake is set.

## Turn signal, high beams, headlight flasher

### Turn signal

## Hints



Do not adjust the exterior mirrors

Do not adjust the exterior mirror while driving and when blinker/hazards are on, or else the additional blinker lights in the exterior mirror are out of position and can't be seen. ◀

## Using turn signals

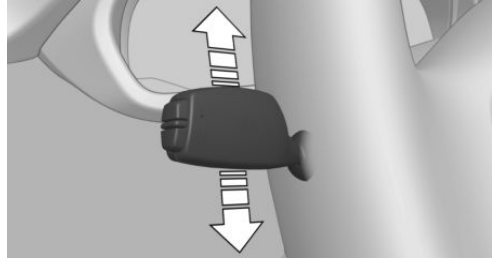

Press the lever beyond the resistance point.

To reel off manually, press the lever to the resistance point.

Unusually rapid flashing of the indicator lamp indicates that a turn signal bulb has failed.

## Triple turn signal activation

Press the lever to the resistance point.

The turn signal flashes three times.

The function can be activated or deactivated.

On the Control Display:

1. "Settings" تلفن شماره ۰۸۵-۸۸۶۲۰۳۱
2. "Lighting"
3. "Triple turn signal"

Settings are stored for the profile currently in use.

## Signaling briefly

Press the lever to the resistance point and hold it there for as long as you want the turn signal to flash.



## High beams, headlight flasher

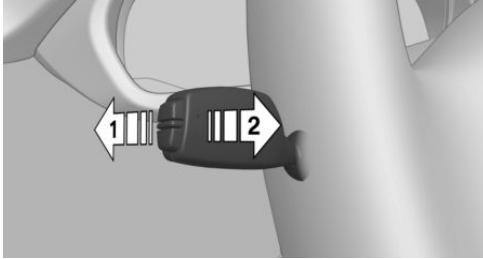

- ▷ High beams, arrow 1.
- ▷ Headlight flasher, arrow 2.

## Washer/wiper system

### Switching the wipers on/off and brief wipe

#### Hints

 Do not activate wipers if frozen to windshield

Do not reel on the wipers if they are frozen to the windshield; otherwise, the wiper blades and the wiper motor may be damaged. ◀

 Do not activate wipers on dry windshield

Do not use the wipers if the windshield is dry, as this may damage the wiper blades or cause them to become worn more quickly. ◀

 Do not activate wipers with wipers folded away

Do not reel on the wipers if they are folded away, otherwise the hood or the wipers may be damaged. ◀

## Switching on

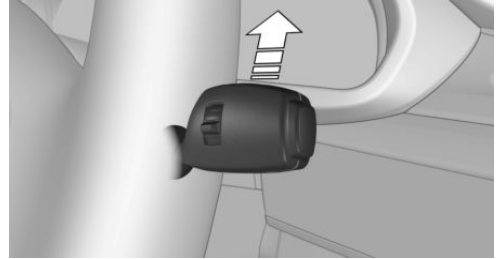

Push wiper lever up.

The lever automatically returns to its initial position when released.

- ▷ Normal wiper speed: push up once.
  - ◆ The wipers reel to intermittent operation when the vehicle is stationary.
- ▷ Fast wiper speed: press up twice or press once beyond the resistance point. Wipers change to normal speed when vehicle comes to standstill.

## Switch off and brief wipe

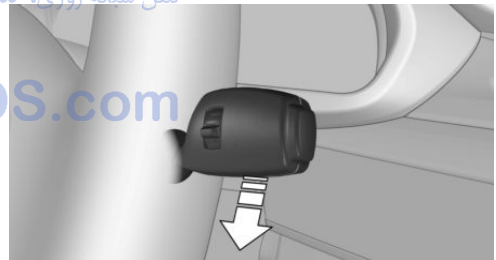

Push wiper lever down.

The lever automatically returns to its initial position when released.

- ▷ Single wipe: press down once.
- ▷ To reel off normal wipe: press down once.
- ▷ To reel off fast wipe: press down twice.

## Intermittent operation or rain sensor

### The concept

Without the rain sensor, the frequency of the wiper operation is preset.

The rain sensor automatically controls the time between wipes depending on the intensity of the rainfall. The sensor is located on the windshield, directly behind the interior rearview mirror.

### Activating/deactivating

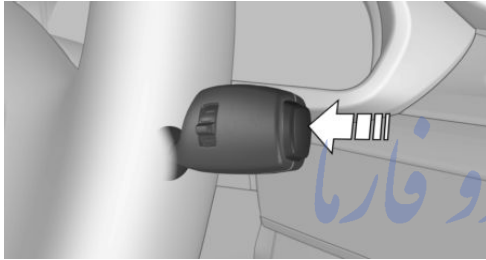

Press button on the wiper lever.

Wiping is started. If the vehicle is equipped with a rain sensor: LED in wiper lever lights up.

When wipers are frozen to windshield, wiper operation is deactivated.

 Deactivate the rain sensor in car washes  
Deactivate the rain sensor when passing through an automatic car wash; otherwise, unintentional wiping can cause damages. ◀

## Setting the frequency or sensitivity of the rain sensor

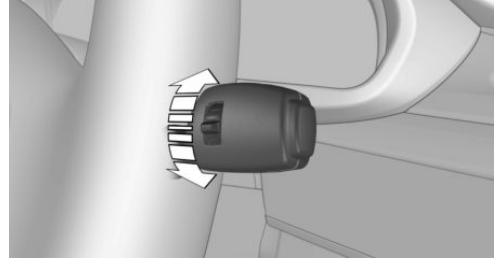

Turn the thumbwheel.

## Clean the windshield, headlights

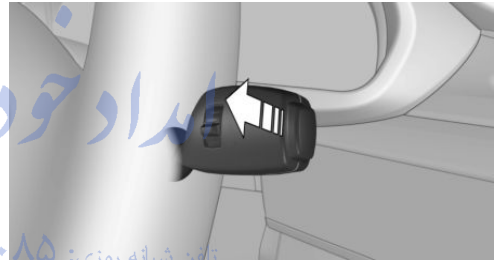

Pull the wiper lever towards you.

The system sprays washer fluid on the windshield and activates the wipers briefly.

In addition, the headlights are cleaned at regular intervals when the vehicle's lights are activated.

 Do not use the washer system at freezing temperatures

Do not use the washers if fluid could freeze onto the windshield which might impede your viewing field. Therefore use antifreeze fluid.

Avoid using the washer when the reservoir is empty; operation might damage pump. ◀

## Windshield washer nozzles

The windshield washer nozzles are automatically heated while the ignition is switched on.

## Fold-out position of the wipers

Fold wipers back when you want to change the blades or with pending low temperatures.

1. Switch the ignition on and off again.
2. With icy conditions make sure that blades are not frozen to the windshield.
3. Press the wiper lever up beyond the point of resistance and hold it for approx. 3 seconds, until the wiper remains in a nearly vertical position.

After the wipers are folded back down, the wiper system must be reactivated.



### Folding wipers back down

Before switching the ignition on, fold the wipers back down to the windshield; otherwise, the wipers may become damaged when they are activated. ◀

1. Switch on the ignition.
2. Push wiper lever down. Wipers move to their resting position and are ready again for operation.

## Washer fluid

### General information



### Antifreeze for washer fluid

Antifreeze is flammable and can cause injury if it is used incorrectly.

Therefore, keep it away from possible sources of ignition.

Only keep it in the closed original container and inaccessible to children.

Follow the notes and instructions on the container.

United States: The washer fluid mixture ratio is regulated by the U.S. EPA and many individual states; do not exceed the allowable washer fluid dilution ratios limits that apply. Follow the usage instructions on the washer fluid con-

tainer. Use BMW's Windshield Washer Concentrate or the equivalent. ◀

### Washer fluid reservoir



### Adding washer fluid

Only add washer fluid when the engine is cool, and then close the cover completely to avoid contact between the washer fluid and hot engine parts.

Otherwise, there is a danger of fire and a risk to personal safety if the fluid is spilled. ◀

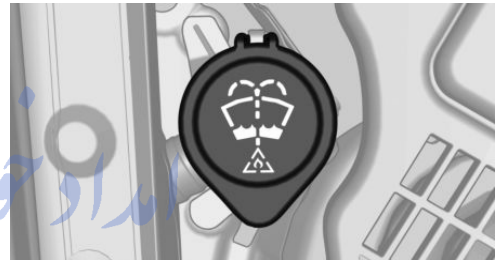

All washer nozzles are supplied from one reservoir.

Fill with a mixture of windshield washer concentrate and tap water and – if required – with a washer antifreeze, according to the manufacturer's recommendations.

Mix the washer fluid before adding to find the right mixture.

Do not add windshield washer concentrate and antifreeze undiluted and do not fill with pure water; this could damage the wiper system.

Do not mix window washer concentrates of different manufacturers because they can clog the windshield washer nozzles.

Recommended minimum fill quantity:  
0.2 US gal/1 liter.

## Steptronic transmission

### Selector lever positions

#### D Drive

Selector lever position for normal vehicle operation. All gears for forward travel are activated automatically.

#### R is Reverse

Select only when the vehicle is stationary.

#### N Neutral:

The vehicle may roll. Use in automatic car washes, e.g.

When the ignition is switched off, refer to page 64, selector lever position P is engaged automatically.

#### P Park

Select only when the vehicle is stationary. The drive wheels are blocked.

P is engaged automatically:

- ▷ After the engine is switched off when the vehicle is in radio-ready state, refer to page 64, or when the ignition is switched off, refer to page 64, and when position R or D is set.
- ▷ With the ignition off, if selector lever position N is set.
- ▷ If the safety belt is unbuckled, the driver's door is opened, and the brake pedal is not pressed while the vehicle is stationary and position D or R is set.

Before exiting the vehicle, make sure that selector lever position P is set. Otherwise, the vehicle may begin to move.

#### Kickdown

Kickdown is used to achieve maximum driving performance. Step on the accelerator pedal beyond the resistance point at the full throttle position.

### Engaging selector lever positions



Press on the brake pedal until you start driving

To prevent the vehicle from creeping after you select a gear, maintain pressure on the brake pedal until you are ready to start. ◀

- ▷ It is not possible to shift out of selector lever position P until the engine is running and the brake is applied.
- ▷ With the vehicle is stationary, press on the brake pedal before shifting out of P or N; otherwise, the shift command will not be executed: shift lock.

### Engaging D, R and N

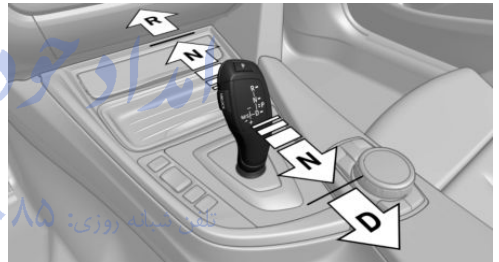

Briefly push the selector lever in the desired direction, beyond a resistance point if needed. After releasing the selector lever, it returns to its center position.



Press unlock button, in order to:

- ▷ Engage R.
- ▷ Shift out of P.

## Engaging P



Press button P.

## Sport program and manual mode

### Activating the sport program



Press the selector lever to the left out of selector lever position D.

The sport program of the transmission is activated.

### Activating the M/S manual mode

1. Press the selector lever to the left out of selector lever position D.
2. Push the selector lever forward or pull it backward.

Manual mode becomes active and the gear is changed.

The engaged gear is displayed in the instrument cluster, e.g., M1.

Once maximum engine speed is attained, M/S manual mode is automatically upshifted as needed.

## Switching to manual mode

- ▶ To shift down: press the selector lever forward.
- ▶ To shift up: pull the selector lever rearwards.

Gears will only be shifted at appropriate engine and road speeds, for example downshifting is not possible if the engine speed is too high.

The selected gear is briefly displayed in the instrument cluster, followed by the currently selected gear.

## Steptronic Sport transmission: prevent automatic upshifting in M/S manual mode

In cars with Steptronic Sport transmission, automatic shift operations are not performed e.g. at maximum engine speed, if one of the following conditions is met:

- ▶ DSC deactivated.
- ▶ TRACTION activated.
- ▶ SPORT+ activated.

In addition, the kickdown is deactivated.

## Ending the sport program/manual mode

Push the selector lever to the right.

D is displayed in the instrument cluster.

## Shift paddles

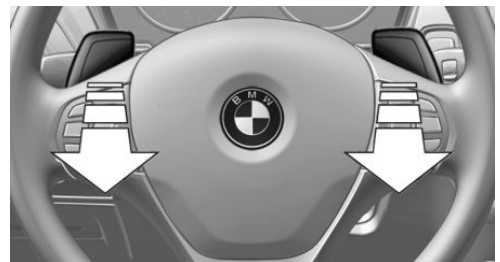

The shift paddles on the steering wheel allow you to shift gears quickly while keeping both hands on the steering wheel.

- ▷ Shift up: briefly pull right shift paddle.
- ▷ Shift down: briefly pull left shift paddle.
- ▷ Shift down into the lowest possible gear: pull and hold left shift paddle.

Gears will only be shifted at appropriate engine and road speeds, for example downshifting is not possible if the engine speed is too high.

The selected gear is briefly displayed in the instrument cluster, followed by the current gear.

If the shift paddles on the steering wheel are used to shift gears in automatic mode, the transmission temporarily switches to manual mode.

If the selector lever is still in selector lever position D, it is possible to reel back into the automatic mode:

- ▷ Pull and hold right shift paddle.

Or

- ▷ In addition to the briefly pulled right shift paddle, briefly pull the left shift paddle.

In the manual mode, if there has been no acceleration or shifting of the shift paddles within a certain amount of time, the transmission switches back to automatic mode.

### Displays in the instrument cluster



The selector lever position is displayed, e.g.: P.

### Electronic unlocking of the transmission lock

#### General information

Electronically unlock the transmission lock to maneuver vehicle from the danger area.

Unlocking is possible, if the started can spin the engine.

### Engaging selector lever position N

1. Depress the brake pedal.
2. Press the Start/Stop button. The starter must audibly start.
3. Press and hold the selector lever into position N.  
A corresponding Check Control message is displayed.
4. Press the selector lever again into position N within approx. 6 seconds.  
Position N is displayed in the instrument cluster.
5. Release brake, as soon as the starter stops.
6. Maneuver the vehicle from the danger area and secure it against moving on its own.

### Steptronic Sport transmission: Launch Control

#### The concept

Launch Control enables optimum acceleration on surfaces with good traction.

#### Hints



Component wear

Do not use Launch Control too often; otherwise, this may result in premature wear of components due to the high stress placed on the vehicle. ◀

Do not use Launch Control during the break-in, refer to page 168, period.

To increase vehicle stability, activate DSC again as soon as possible.

An experienced driver may be able to achieve better acceleration values in DSC OFF mode.

#### Requirements

Launch Control is available when the engine is warmed up, that is, after uninterrupted driving of at least 6 miles/10 km.

To start with Launch Control do not steer the steering wheel.

### Start with launch control

While the engine is running:

-  Press button or select Sport+ with the Driving Dynamics Control.  
TRACTION is displayed in the instrument cluster and the indicator lamp for DSC OFF lights up.
- Engage selector lever position S.
- With the left foot, forcefully press down on the brake.
- Press and hold down the accelerator pedal beyond the resistance point at the full throttle position.  
A flag symbol is displayed in the instrument cluster.
- The starting engine speed adjusts. Within 3 seconds, release the brake.

Before using Launch Control, allow the transmission to cool down for approx. 5 minutes.

Launch Control adjusts to the surrounding conditions, e.g., wet pavement, when used again.

# Displays

## Vehicle features and options

This chapter describes all standard, country-specific and optional features offered with the series. It also describes features that are not

necessarily available in your car, e. g., due to the selected options or country versions. This also applies to safety-related functions and systems.

## Overview, instrument cluster

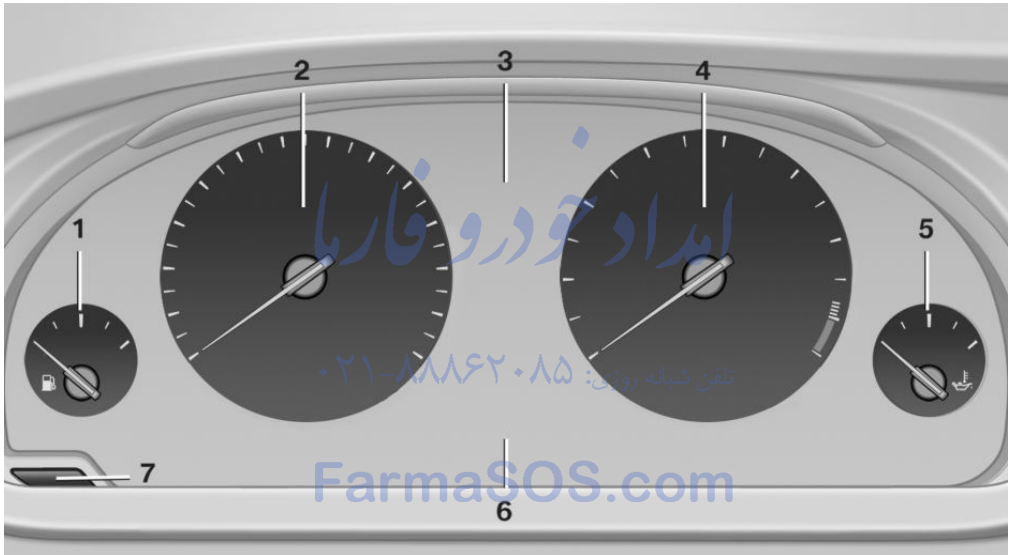

- |                                 |   |
|---------------------------------|---|
| 1 Fuel gauge <a href="#">80</a> | 5 Engine oil temperature <a href="#">80</a> |
| 2 Speedometer                   | 6 Electronic displays <a href="#">76</a>    |
| 3 Messages, e.g. Check Control  | 7 Reset miles <a href="#">81</a>            |
| 4 Tachometer <a href="#">80</a> |   |

## Electronic displays

- ▷ Selection lists, refer to page [85](#).
- ▷ External temperature, refer to page [81](#).
- ▷ Auto Start/Stop function, refer to page [66](#).
- ▷ Onboard computer, refer to page [85](#).
- ▷ Date, refer to page [81](#).
- ▷ Energy recovery, refer to page [82](#).
- ▷ Transmission display, refer to page [74](#).
- ▷ Miles/trip miles, refer to page [81](#).



- Messages, e.g. Check Control, refer to page 77.
- Current fuel consumption, refer to page 82.
- Navigation display, see User's manual for Navigation, Entertainment and Communication.
- Range, refer to page 81.
- Status, Driving Dynamics Control, refer to page 121.
- Service requirements, refer to page 82.
- Speed limit detection, refer to page 83.
- Time, refer to page 81.

## Check Control

### The concept

The Check Control system monitors functions in the vehicle and notifies you of malfunctions in the monitored systems.

A Check Control message is displayed as a combination of indicator or warning lights and text messages in the instrument cluster and in the Head-up Display.

In addition, an acoustic signal may sound and a text message may appear on the Control Display.

### Indicator/warning lights

#### General information

The indicator and warning lights in the instrument cluster can light up in a variety of combinations and colors.

Several of the lights are checked for proper functioning and light up temporarily when the engine is started or the ignition is switched on.

## Red lights

### Safety belt reminder



Flashing or illuminated: safety belt on the driver or passenger side is not buckled. The safety belt reminder can also be activated if objects are placed on the front passenger seat.

Make sure that the safety belts are positioned correctly.

### Airbag system



Airbag system and belt tensioner are defective.

Have the vehicle checked by the service center immediately.

### Parking brake, brake system



For additional information, refer to Release parking brake, refer to page 68.



### Front-end collision warning



Illuminated: advance warning is issued, e.g., when there is the impending danger of a collision or the distance to the vehicle ahead is too small.

Increase distance.

Flashing: acute warning of the imminent danger of a collision when the vehicle approaches another vehicle at a relatively high differential speed.

Intervention by braking or make an evasive maneuver.

### Pedestrian warning



Symbol in the instrument cluster.

If a collision with a person detected in this way is imminent, the symbol lights up and a signal sounds.

## Orange lights

### Active Cruise Control



The number bars shows the selected distance from the vehicle driving ahead.

For additional information, refer to Active Cruise Control with Stop & Go function, ACC, refer to page 124.

### Vehicle detection, Active Cruise Control



Illuminated: vehicle driving ahead detected.

Flashing: the conditions are not adequate for operating the system.

The system was deactivated but applies the brakes until you actively resume control by pressing on the brake pedal or accelerator pedal.

## Yellow lights

### Antilock Brake System ABS



It reduces the braking distance to a minimum during emergency stops.



Illuminated: avoid abrupt braking if possible. Braking force boost in some cases defective. Stop carefully. Take into account longer brake travel. Have this checked by the service center immediately.

### DSC Dynamic Stability Control



Flashing: DSC controls the drive and braking forces. The vehicle is stabilized. Reduce speed and adapt driving profile to the driving circumstances.

Illuminated: DSC failed. Have the system checked by the service center.

For additional information, refer to Dynamic Stability Control DSC, refer to page 119.

### DSC Dynamic Stability Control is deactivated or DTC Dynamic Traction Control is activated



Dynamic Stability Control DSC is switched off or Dynamic Traction Control DTC is switched on.

For additional information, refer to Dynamic Stability Control, refer to page 119, and Dynamic Traction Control, refer to page 120.

### FTM Flat Tire Monitor



The Flat Tire Monitor signals a loss of tire inflation pressure in a tire.

Reduce your speed and stop cautiously. Avoid sudden braking and steering maneuvers.

For more information, see Flat Tire Monitor, refer to page 104.

### Tire Pressure Monitor TPM



Illuminated: the Tire Pressure Monitor signals a loss of tire inflation pressure in a tire.

Reduce your speed and stop cautiously. Avoid sudden braking and steering maneuvers.

Flashing and then continuously illuminated: no flat tire or loss of tire inflation pressure can be detected.

- ▶ Interference through systems or devices with the same radio frequency: after leaving the area of the interference, the system automatically becomes active again.
- ▶ RDC could not conclude the reset: perform the reset of the system again.
- ▶ A wheel without TPM electronics is fitted: have the service center check it if needed.
- ▶ Malfunction: have the system checked by your service center.

For more information, see Tire Pressure Monitor, refer to page 100.

### Steering system



Steering system in some cases defective.

Have the steering system checked by the service center.

### Engine functions



Have the vehicle checked by the service center.

For additional information, refer to On-board Diagnostics socket, refer to page 204.

### Lane departure warning



System is switched on and under certain circumstances warns if a detected lane is left without flashing beforehand.

For additional information, refer to Lane departure warning, refer to page 114.

### Green lights

#### Turn signal



Turn signal on.

Unusually rapid flashing of the indicator lamp indicates that a turn signal bulb has failed.

For additional information, refer to Turn signal, refer to page 68.

### Parking lights, headlight control



Parking lights or headlights are activated.

For additional information, refer to Parking lights/low beams, headlight control, refer to page 91.

### Front fog lights



Front fog lights are activated.

For additional information, refer to Front fog lights, refer to page 94.

### High-beam Assistant



High-beam Assistant is switched on.

High beams are activated and off automatically as a function of the traffic situation.

For additional information, refer to High-beam Assistant, refer to page 93.

### Cruise control



The system is switched on. It maintains the speed that was set using the control elements on the steering wheel.

### Blue lights

#### High beams



High beams are activated.

For additional information, refer to High beams, refer to page 69.

### General lamps

#### Check Control



At least one Check Control message is displayed or is stored (symbol in display).

### Text messages

Text messages in combination with a symbol in the instrument cluster explain a Check Control message and the meaning of the indicator and warning lights.

## Supplementary text messages

Additional information, such as on the cause of an error or the required action, can be called up via Check Control.

With urgent messages the added text will be automatically displayed on the Control Display.

## Symbols

Depending on the Check Control message, the following functions can be selected.

- ▷  "Owner's Manual"

Display additional information about the Check Control message in the Integrated Owner's Manual.

- ▷  "Service request"

Contact your service center.

- ▷  "Roadside Assistance"

Contact Roadside Assistance.

## Hiding Check Control messages

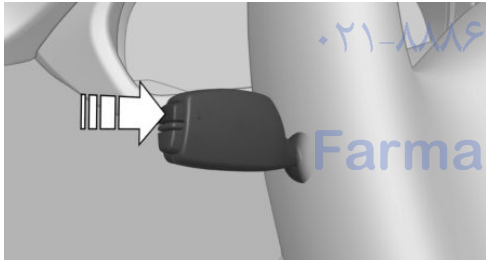

Press the onboard computer button on the turn signal lever.

- ▷ Some Check Control messages are displayed continuously and are not cleared until the malfunction is eliminated. If several malfunctions occur at once, the messages are displayed consecutively. These messages can be faded for approx. 8 seconds. After this time, they are displayed again automatically.
- ▷ Other Check Control messages are faded automatically after approx. 20 seconds.

They are stored and can be displayed again later.

## Displaying stored Check Control messages

On the Control Display:

1. "Vehicle info"
2. "Vehicle status"
3.  "Check Control"
4. Select the text message.

## Messages after trip completion

Special messages displayed while driving are displayed again after the ignition is switched off.

## Fuel gauge



Vehicle tilt position may cause the display to vary.

Depending on the equipment version, the arrow beside the fuel pump symbol shows which side of the vehicle the fuel filler flap is on.

Hints on refueling, refer to page 184.

## Tachometer

Always avoid engine speeds in the red warning field. In this range, the fuel supply is interrupted to protect the engine.

## Engine oil temperature

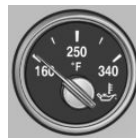

- ▷ Cold engine: the pointer is at the low temperature end. Drive at moderate engine and vehicle speeds.
- ▷ Normal operating temperature: the pointer is in the

middle or in the left half of the temperature display.

- ▶ Hot engine: the pointer is at the high end of the temperature range. A Check Control message is also displayed.

## Coolant temperature

If the coolant along with the engine becomes too hot, a Check Control message is displayed. Check the coolant level, refer to page 203.

## Odometer and trip odometer

### Display

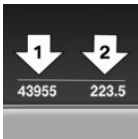

- ▶ Odometer, arrow 1.
- ▶ Trip odometer, arrow 2.

### Show/reset kilometers



Press the knob.

- ▶ When the ignition is switched off, the time, the external temperature and the odometer are displayed.
- ▶ When the ignition is switched on, the trip odometer is reset.

## External temperature

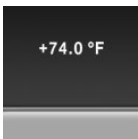

If the indicator drops to +37 °F/+3 °C or lower, a signal sounds.

A Check Control message is displayed.

There is an increased risk of ice on roads.



Ice on roads

Even at temperatures above +37 °F/+3 °C, roads might be icy.

Therefore, drive carefully on bridges and shaded roads, e.g., to avoid the increased risk of an accident. ◀

## Time

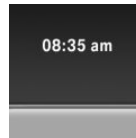

The time is displayed at the bottom of the instrument cluster.

Setting the time and time format, refer to page 88.

## Date

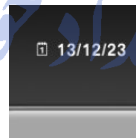

The date is displayed in the computer.

Setting the date and date format, refer to page 88.

## Range

### Display

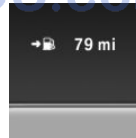

With a low remaining range:

- ▶ A Check Control message is displayed briefly.
- ▶ The remaining range is shown on the computer.
- ▶ With a dynamic driving style - e.g., taking curves aggressively - engine operation might vary.

The Check Control message appears continuously below a range of approx. 30 miles/50 km.



Refuel promptly

Refuel no later than at a range of 30 miles/50 km or engine operation might fail and damage might occur. ◀

## Displaying the cruising range

Depending on your vehicle's optional features, the range can also be displayed as bar in the instrument cluster.

1. "Settings"
2. "Instrument cluster"
3. "Additional indicators"

## Current fuel consumption

### Instrument cluster

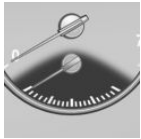

Displays the current fuel consumption. Check whether you are currently driving in an efficient and environmentally-friendly manner.

### Instrum. cluster with enhanced features



Displays the current fuel consumption. Check whether you are currently driving in an efficient and environmentally-friendly manner.

## Displaying the current fuel consumption

1. "Settings"
2. "Instrument cluster"
3. "Additional indicators"

The bar display for the current fuel consumption is displayed in the instrument cluster.

## Energy recovery

### Display



The kinetic energy of the vehicle is converted to electrical energy while coasting. The vehicle battery is partially charged and fuel consumption can be reduced.

## Service requirements

### The concept

After the ignition is turned on the instrument cluster briefly displays available driving distance or time to the next scheduled maintenance.

Your service specialist can read the current service requirements from your remote control.

### Display

Data regarding the service status or legally mandated vehicle inspections are automatically transmitted to your service center before a service due date.

### Detailed information on service requirements

More information on the scope of service required can be displayed on the Control Display.



On the Control Display:

1. "Vehicle info"
2. "Vehicle status"
3.  "Service required"

Required maintenance procedures and legally mandated inspections are displayed.

4. Select an entry to call up detailed information.

## Symbols

| Symbols  | Description   |
|--|---|
|  | No service is currently required.   |
|  | The deadline for scheduled maintenance or a legally mandated inspection is approaching. |
|  | The service deadline has already passed.  |

## Entering appointment dates

Enter the dates for the required inspections.

Make sure that the vehicle's date and time are set correctly.

On the Control Display:

- "Vehicle info"
- "Vehicle status"
-  "Service required"
- "§ Vehicle inspection"
- "Date:"
- Adjust the settings.
- Confirm.

The entered date is stored.

## Automatic Service Request

Data regarding the service status or legally mandated vehicle inspections are automatically transmitted to your service center before a service due date.

You can check when your service center was notified.

On the Control Display:

- "Vehicle info"
- "Vehicle status"
- Open "Options".
- "Last Service Request"

## Gear shift indicator



### The concept

The system recommends the most fuel efficient gear for the current driving situation.

Depending on the vehicle's features and country version of the vehicle, the gear shift indicator is active in the manual mode of the Steptronic transmission and with manual transmission.

Suggestions to shift gear up or down are displayed in the instrument cluster.

### Steptronic transmission: displays

| Example   | Description                     |
|---|---------------------------------|
|  | Fuel efficient gear is set.     |
|  | Shift into fuel efficient gear. |

## Speed limit detection

### The concept

#### Speed limit detection

Speed limit detection uses a symbol in the shape of a traffic sign to display the currently detected speed limit. The camera in the area of the interior rearview mirror detects traffic signs at the edge of the road as well as variable overhead sign posts. Traffic signs with extra symbols for wet road conditions, etc. are also detected and compared with the vehicle's onboard data, such as for the rain sensor, and will be displayed depending on the situation. The system takes into account the information stored in the navigation system and also displays speed limits present on routes without signs.

## Hints



### Personal judgment

The system cannot serve as a substitute for the driver's personal judgment of the traffic situation.

The system assists the driver and does not replace the human eye. ◀

## At a glance

## Camera

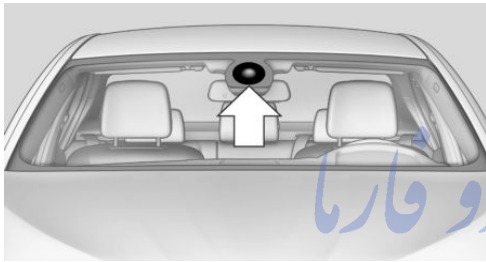

The camera is found near the interior rearview mirror.

Keep the windshield in the area behind the interior rearview mirror clean and clear.

## Switching on/off

On the Control Display:

1. "Settings"
2. "Instrument cluster"
3. "Speed limit information"

If speed limit detection is switched on, it can be displayed on the info display in the instrument cluster via the computer.

## Display

The following is displayed in the instrument cluster:

## Speed limit detection

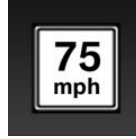

Current speed limit.

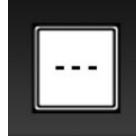

Speed limit detection is not available.

Speed limit detection can also be displayed in the Head-up Display.

## System limits

The system may not be fully functional and may provide incorrect information in the following situations:

- ▷ In heavy fog, rain or snowfall.
- ▷ When signs are concealed by objects.
- ▷ When driving very close to the vehicle in front of you.
- ▷ When driving toward bright lights.
- ▷ When the windshield behind the interior rearview mirror is fogged over, dirty or covered by a sticker, etc.
- ▷ In the event of incorrect detection by the camera.
- ▷ If the speed limits stored in the navigation system are incorrect.
- ▷ In areas not covered by the navigation system.
- ▷ When roads differ from the navigation, such as due to changes in road routing.
- ▷ When passing buses or trucks with a speed sticker.
- ▷ If the traffic signs are non-conforming.
- ▷ During calibration of the camera immediately after vehicle shipment.



## Selection lists in the instrument cluster

### The concept

Depending on your vehicle's optional features, the following can be displayed or operated using the buttons and the thumbwheel on the steering wheel as well as the displays in the instrument cluster and the Head-up Display:

- ▷ Current audio source.
- ▷ Redial phone feature.
- ▷ Turn on voice activation system.

It also displays programs of the Driving Dynamics Control.

### Display

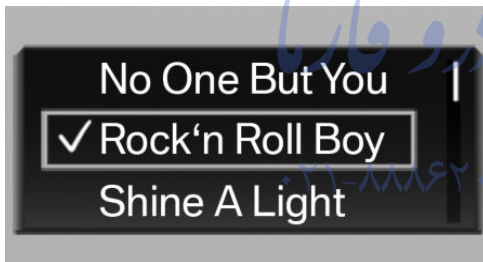

Depending on your vehicle's optional features, the list in the instrument cluster can differ from the illustration shown.

## Activating a list and adjusting the setting

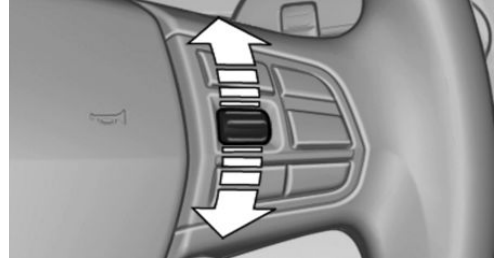

On the right side of the steering wheel, turn the thumbwheel to activate the corresponding list.

Using the thumbwheel, select the desired setting and confirm it by pushing the thumbwheel.

## Computer

### Indication in the info display

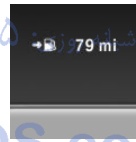

The information from the computer is shown in the info display in the instrument cluster.

### Calling up information on the info display

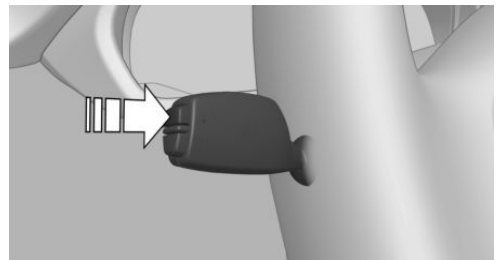

Press the onboard computer button on the turn signal lever.

Information is displayed in the info display of the instrument cluster.

## Information at a glance

Repeatedly pressing the button on the turn signal lever calls up the following information in the info display:

- ▷ Range.
- ▷ Average fuel consumption.
- ▷ Current fuel consumption.
- ▷ Average speed.
- ▷ Date.
- ▷ Speed limit detection.
- ▷ Time of arrival.

When destination guidance is activated in the navigation system.

- ▷ Distance to destination.

When destination guidance is activated in the navigation system.

- ▷ ECO PRO bonus range.

## Adjusting the info display

Depending on the vehicle equipment version, you can select what information from the computer is to be displayed on the info display of the instrument cluster.

On the Control Display:

1. "Settings"
2. "Instrument cluster"
3. Select the desired displays.

## Information in detail

### Range

Displays the estimated cruising range available with the remaining fuel.

It is calculated based on your driving style over the last 20 miles/30 km.

If there is only enough fuel left for less than 45 miles/80 km, the color of the display changes.

## Average fuel consumption

The average fuel consumption is calculated for the period while the engine is running.

The average fuel consumption is calculated for the distance traveled since the last reset by the computer.

## Average speed

Periods in which the vehicle is parked with the engine manually stopped are not included in the calculation of the average speed.

## Resetting average values

Press and hold the onboard computer button on the turn signal lever.

## Distance to destination

The distance remaining to the destination is displayed if a destination is entered in the navigation system before the trip is started.

The distance to the destination is adopted automatically.

## Time of arrival

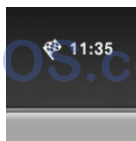

The estimated time of arrival is displayed if a destination is entered in the navigation system before the trip is started.

The time must be correctly set.

## Speed limit detection

Description of the speed limit detection, refer to page 83, function.

## Trip computer

The vehicle features two types of board computers.

- ▷ "Onboard info": the values can be reset as often as necessary.
- ▷ "Trip computer": the values provide an overview of the current trip.

## Resetting the trip computer

On the Control Display:

1. "Vehicle info"
2. "Trip computer"
3. "Reset": all values are reset.  
"Automatically reset": all values are reset approx. 4 hours after the vehicle came to a standstill.

## Display on the Control Display

Display the computer or trip computer on the Control Display.

1. "Vehicle info"
2. "Onboard info" or "Trip computer"

## Resetting the fuel consumption or speed

On the Control Display:

1. "Vehicle info"
2. "Onboard info"
3. "Consumpt." or "Speed"
4. "Yes"

## Sport displays

### The concept

On the Control Display, the current values for performance and torque can be displayed if the vehicle is appropriately equipped.

### Displaying sport displays on the Control Display

1. "Vehicle info"
2. "Sport displays"

## Speed warning

### The concept

Displays a speed, when reached, should cause a warning to be issued.

The warning is repeated if the vehicle speed drops below the set speed once by at least 3 mph/5 km/h.

### Displaying, setting or changing the speed warning

On the Control Display:

1. "Settings"
2. "Speed"
3. "Warning at:"
4. Turn the controller until the desired speed is displayed.
5. Press the controller.  
Speed warning is stored.

### Activating/deactivating the speed warning

On the Control Display:

1. "Settings"
2. "Speed"
3. "Warning"
4. Press the controller.

### Setting your current speed as the speed warning

On the Control Display:

1. "Settings"
2. "Speed"
3. "Select current speed"
4. Press the controller.

The current vehicle speed is stored as the speed warning.

## Settings on the Control Display

### Time

#### Setting the time zone

1. "Settings"
2. "Time/Date"
3. "Time zone:"
4. Select the desired time zone.

The time zone is stored.

#### Setting the time

1. "Settings"
2. "Time/Date"
3. "Time:"
4. Turn the controller until the desired hours are displayed.
5. Press the controller.
6. Turn the controller until the desired minutes are displayed.
7. Press the controller.

The time is stored.

#### Setting the time format

1. "Settings"
2. "Time/Date"
3. "Format:"
4. Select the desired format.

The time format is stored.

#### Automatic time setting

Depending on your vehicle's optional features, the time, date and, if needed, the time zone are updated automatically.

1. "Settings"
2. "Time/Date"
3. "Auto time set"

### Date

#### Setting the date

1. "Settings"
2. "Time/Date"
3. "Date:"
4. Turn the controller until the desired day is displayed.
5. Press the controller.
6. Make the necessary settings for the month and year.

The date is stored.

#### Setting the date format

1. "Settings"
2. "Time/Date"
3. "Format:"
4. Select the desired format.

The date format is stored.

### Language

#### Setting the language

To set the language on the Control Display:

1. "Settings"
2. "Language/Units"
3. "Language:"
4. Select the desired language.

Settings are stored for the profile currently in use.

#### Setting the voice dialog

Voice dialog for the voice activation system, refer to page [27](#).

## Units of measure

### Setting the units of measure

To set the units for fuel consumption, route/ distance and temperature:

1. "Settings"
2. "Language/Units"
3. Select the desired menu item.
4. Select the desired unit.

Settings are stored for the profile currently in use.

## Brightness

### Setting the brightness

To set the brightness of the Control Display:

1. "Settings"
2. "Control display"
3. "Brightness"
4. Turn the controller until the desired brightness is set.
5. Press the controller.

Settings are stored for the profile currently in use.

Depending on the light conditions, the brightness settings may not be clearly visible.

## Assist system information

### Display on the Control Display

Information on the Assist system can be displayed by activating Assist on the Control Display.

1. "Settings"
2. "Control display"
3. "Driver assistance info"

## Head-up Display

### The concept

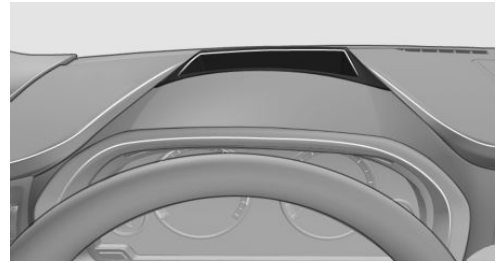

This system projects important information into the driver's field of vision, e.g., the speed.

The driver can get information without averting his or her eyes from the road.

### Display visibility

The visibility of the displays in the Head-up Display is influenced by the following factors:

- ▷ Certain sitting positions.
- ▷ Objects on the cover of the Head-up Display.
- ▷ Sunglasses with certain polarization filters.
- ▷ Wet roads.
- ▷ Unfavorable light conditions.

If the image is distorted, check the basic settings.

### Switching on/off

1. "Settings"
2. "Head-Up Display"
3. "Head-Up Display"

## Display

### Overview

- ▷ Speed.
- ▷ Navigation system.
- ▷ Check Control messages.
- ▷ Selection list from the instrument cluster.

- ▷ Driver assistance systems.

Some of this information is only displayed briefly as needed.

### Selecting displays in the Head-up Display

On the Control Display:

1. "Settings"
2. "Head-Up Display"
3. "Displayed information"
4. Select the desired displays in the Head-up Display.

Settings are stored for the profile currently in use.

### Setting the brightness

The brightness is automatically adjusted to the ambient brightness.

The basic setting can be adjusted manually.

On the Control Display:

1. "Settings"
2. "Head-Up Display"
3. "Brightness"
4. Turn the controller.

When the low beams are activated, the brightness of the Head-up Display can be additionally influenced using the instrument lighting.

Settings are stored for the profile currently in use.

### Adjusting the height

On the Control Display:

1. "Settings"
2. "Head-Up Display"
3. "Height"
4. Turn the controller.

Settings are stored for the profile currently in use.

### Setting the rotation

On the Control Display:

1. "Settings"
2. "Head-Up Display"
3. "Rotation"
4. Turn the controller.

Settings are stored for the profile currently in use.

### Special windshield

The windshield is part of the system.

The shape of the windshield makes it possible to display a precise image.

A film in the windshield prevents double images from being displayed.

Therefore, have the special windshield replaced by a service center only.

تلفن شبانه روزی: ۰۲۱-۸۸۸۶۲۰۸۵

FarmaSOS.com

# Lights

## Vehicle features and options

This chapter describes all standard, country-specific and optional features offered with the series. It also describes features that are not necessarily available in your car, e. g., due to the selected options or country versions. This also applies to safety-related functions and systems.

## At a glance

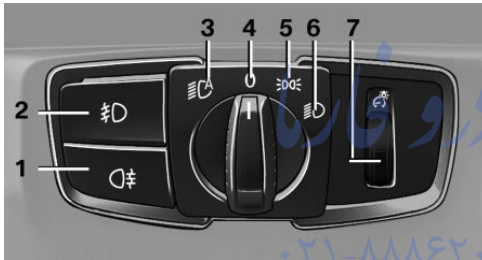

- 1 Rear fog lights
- 2 Front fog lights
- 3 Depending on the equipment: automatic headlight control, Adaptive Light Control, High-beam Assistant, Welcome lights, Daytime running lights
- 4 Lights off, daytime running lights
- 5 Parking lights, daytime running lights
- 6 Depending on the equipment: low beams, welcome lights, High-beam Assistant
- 7 Instrument lighting

## Parking lights/low beams, headlight control

### General information

Position of switch: 0, , 

If the driver door is opened with the ignition switched off, the exterior lighting is automatically switched off at these reel settings.

### Parking lights

Position of switch   : the vehicle's lights light up on all sides, e.g., for parking.



Do not use the parking lights for extended periods; otherwise, they might drain the battery and it would then be impossible to start the engine.

When parking, it is preferable to reel on the one-sided roadside parking lights, refer to page 92.

### Low beams

Position of switch  with the ignition switched on: the low beams light up.

### Welcome lights

When the vehicle is parked, leave the reel in position  or  : parking and interior lights come on briefly when the vehicle is unlocked depending on the ambient brightness.

### Activating/deactivating

On the Control Display:

1. "Settings"
2. "Lighting"
3. "Welcome lights"

Settings are stored for the profile currently in use.

### Headlight courtesy delay feature

The low beams stay lit for a short while if the headlight flasher is switched on after the radio-ready state is switched off.

## Setting the duration

On the Control Display:

1. "Settings"
2. "Lighting"
3. "Pathway lighting"
4. Set length of time.

Settings are stored for the profile currently in use.

## Automatic headlight control

Position of switch  : the low beams are activated and off automatically, e.g., in tunnels, in twilight or if there is precipitation. The indicator lamp in the instrument cluster lights up.

When emerging from a tunnel during the day, the low beams are not switched off immediately but instead only after approx. 2 minutes.

A blue sky with the sun low on the horizon can cause the lights to be switched on.



The low beams always stay on when the fog lights are activated.

### Personal responsibility

The automatic headlight control cannot serve as a substitute for your personal judgment in determining when to turn the lights on in response to ambient lighting conditions.

E. g. the sensors are unable to detect fog or hazy weather. To avoid safety risks under these conditions, you should always switch on the lights manually. ◀

## Daytime running lights

With the ignition switched on, the daytime running lights light up in position 0,  or  . After the ignition is switched off, the parking lights light up in position  .

## Activating/deactivating

In some countries, daytime running lights are mandatory, so it may not be possible to deactivate the daytime running lights.

On the Control Display:

1. "Settings"
2. "Lighting"
3. "Daytime running lamps"

Settings are stored for the profile currently in use.

## Roadside parking lights

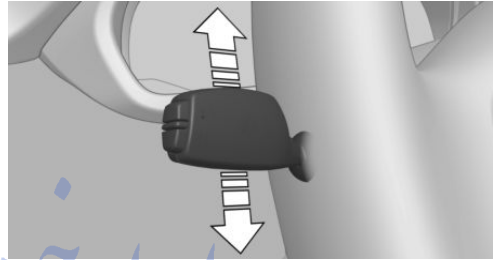

The vehicle can be illuminated on one side.

### Switching on

With the ignition switched off, press the lever either up or down past the resistance point for approx. 2 seconds.

### Switch off

Briefly press the lever to the resistance point in the opposite direction.

## Adaptive Light Control

### The concept

Adaptive Light Control is a variable headlight control system that enables dynamic illumination of the road surface.

Depending on the steering angle and other parameters, the light from the headlight follows the course of the road.

In tight curves, e.g., on mountainous roads or when turning, one of the two front fog lights is switched on as a turning lamp. As a result the inside of the curve is better lighted.



## Activating

Position of switch  with the ignition switched on.

To avoid blinding oncoming traffic, the Adaptive Light Control does not swivel to the driver's side when the vehicle is at a standstill.

The turning lights are automatically switched on depending on the steering angle or the use of turn signals.

When driving in reverse, the turning lights may be automatically switched on regardless of the steering angle.

## Malfunction

A Check Control message is displayed.

Adaptive Light Control is malfunctioning or has failed. Have the system checked as soon as possible.



## High-beam Assistant

### The concept

When the low beams are activated, this system automatically switches the high beams on and off or suppresses the light in the areas that blind oncoming traffic. The procedure is controlled by a camera on the front of the interior rearview mirror. The assistant ensures that the high beams are activated whenever the traffic situation allows. The driver can intervene at any time and reel the high beams on and off as usual.

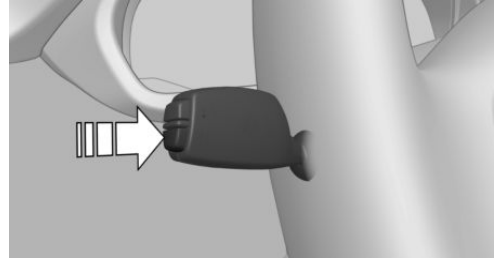
## Activating



1. Depending on the equipment, turn the light switch into position  or .
2. Press button on the turn signal lever, arrow.



The indicator lamp in the instrument cluster lights up.

When the low beams are on, the lights are automatically brightened or dimmed.

The system responds to light from oncoming traffic and traffic driving ahead of you, and to adequate illumination, e.g., in towns and cities.



The blue indicator lamp in the instrument cluster lights up when the system switches on the high beams. Depending on the version of the system in the vehicle, the high beams may not reel off for oncoming vehicles, but may only be dimmed in the areas that blind oncoming traffic. In this case, the blue indicator light will stay on.

## Switching the high beams on and off manually

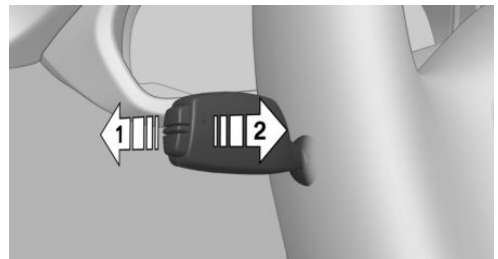

- ▷ High beams on, arrow 1.

- ▷ High beams off/headlight flasher, arrow 2.

The High-beam Assistant can be switched off when manually adjusting the light. To reactivate the High-beam Assistant, press the button on the turn signal lever.

## System limits



### Personal responsibility

The High-beam Assistant cannot serve as a substitute for the driver's personal judgment of when to use the high beams. Therefore, manually reel off the high beams in situations where required to avoid a safety risk. ◀

The system is not fully functional in situations such as the following, and driver intervention may be necessary:

- ▷ In very unfavorable weather conditions, such as fog or heavy precipitation.
- ▷ When detecting poorly-lit road users such as pedestrians, cyclists, horseback riders and wagons; when driving close to train or ship traffic; and at animal crossings.
- ▷ In tight curves, on hilltops or in depressions, in cross traffic or half-observed oncoming traffic on freeways.
- ▷ In poorly-lit towns and cities and in the presence of highly reflective signs.
- ▷ At low speeds.
- ▷ When the windshield behind the interior rearview mirror is fogged over, dirty or covered with stickers, etc.

## Fog lights

### Front fog lights

The low beams must be switched on.



Press button. The green indicator lamp lights up.

If the automatic headlight control, refer to page 92, is activated, the low beams will come

on automatically when you reel on the front fog lights.

When the high beams or headlight flasher are activated, the front fog lights are not switched on.

## Instrument lighting

### Adjusting



The parking lights or low beams must be switched on to adjust the brightness.

Adjust the brightness with the thumbwheel.

## Interior lights

### General information

The interior lights, footwell lights, access lights and courtesy lights are controlled automatically. تلفن شبانه روزی: ۰۲۰۸۸۶۲۰۸۸۶۲

Thumb wheel for the instrument lighting controls brightness of some of these features.



- 1 Interior lights
- 2 Reading lamp

### Switching the interior lights on and off



Press button.

To reel off permanently: press the button for approx. 3 seconds.

Switch back on: press button.

## Reading lights



Press button.

Reading lights are located at the front and rear next to the interior lights.

## Ambient light

Depending on your optional features lighting can be adjusted for some lights in the interior.

## Selecting color scheme

On the Control Display:

1. "Settings"
2. "Lighting"
3. "Ambient:"
4. Select desired setting.

With a color scheme selected and welcome lights activated they illuminate in the line's color when vehicle is unlocked.

## Setting the brightness

The brightness of the ambient light can be adjusted via the thumbwheel for the instrument lighting or on the Control Display.

On the Control Display:

1. "Settings"
2. "Lighting"
3. "Brightness:"
4. Adjust the brightness.

# Safety

## Vehicle features and options

This chapter describes all standard, country-specific and optional features offered with the series. It also describes features that are not

necessarily available in your car, e. g., due to the selected options or country versions. This also applies to safety-related functions and systems.

## Airbags

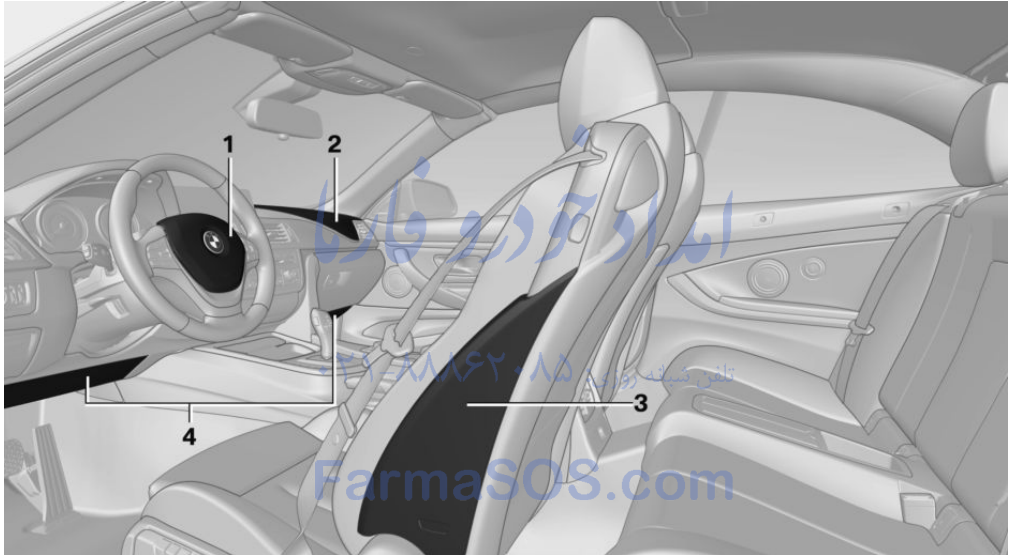

- |                                 |                |
|---------------------------------|----------------|
| 1 Front airbag, driver          | 3 Side airbag  |
| 2 Front airbag, front passenger | 4 Knee airbags |

### Front airbags

Front airbags help protect the driver and front passenger by responding to frontal impacts in which safety belts alone would not provide adequate restraint.

### Side airbags

In a lateral impact, the side airbag supports the side of the body in the chest, lap, and head area.

### Knee airbag

The knee airbag supports the legs in a frontal impact.

### Protective action

Airbags are not triggered in every impact situation, e.g., in less severe accidents or rear-end collisions.



Information on how to ensure the optimal protective effect of the airbags

- ▷ Keep at a distance from the airbags.
- ▷ Always grasp the steering wheel on the steering wheel rim, holding your hands at the 3 o'clock and 9 o'clock positions, to keep the risk of injury to your hands or arms as low as possible when the airbag is triggered.
- ▷ There should be no person, animals, or objects between an airbag and a person.
- ▷ Do not use the cover of the front airbag on the front passenger side as a storage area.
- ▷ Dashboard and windshield on the front passenger side must stay clear - do not attach adhesive labels or coverings and do not attach brackets or cables, e. g., for GPS devices or mobile phones.
- ▷ Make sure that the front passenger is sitting correctly, i.e., keeps his or her feet and legs in the footwell; otherwise, leg injuries might occur when front airbag is activated.
- ▷ Do not place slip covers, seat cushions or other objects on the front passenger seat that are not approved specifically for seats with integrated side airbags.
- ▷ Do not hang pieces of clothing, such as jackets, over the backrests.
- ▷ Make sure that occupants keep their heads away from the side airbag; otherwise, injuries might occur when airbag is activated.
- ▷ Do not remove the airbag system.
- ▷ Do not remove the steering wheel.
- ▷ Do not apply adhesive materials to the airbag cover panels, do not cover them or modify them in any way.
- ▷ Never modify either the individual components or the wiring in the airbag system. This also applies to steering wheel covers, the dashboard, and the seats. ◀

Even when you follow all instructions very closely, injury from contact with the airbags cannot be ruled out in certain situations.

The ignition and inflation noise may lead to short-term and, in most cases, temporary hearing impairment in sensitive individuals.



**Malfunction, deactivation and after deploying the airbags**

Do not touch the individual components immediately after the system has been triggered; otherwise, you may risk burns.

Only have the airbags checked, repaired or dismantled and the airbag generator scrapped by the service center or an authorized repair shop for handling explosives.

Non-professional attempts to service the system could lead to failure in an emergency or unintentional activation of the airbag - both may lead to injury. ◀

Warnings and information on the airbags are also found on the sun visors.

### Functional readiness of the airbag system



When the ignition is reel on, the warning lamp in the instrument cluster lights up briefly and thereby indicates the operational readiness of the entire airbag system and the belt tensioner.

### Airbag system malfunctioning

- ▷ Warning lamp does not come on when the ignition is turned on.
- ▷ The warning lamp lights up continuously.



**In case of a malfunction have airbag system checked immediately.**

In case of a malfunction have airbag system checked immediately; otherwise, there is a risk that the system does not function as expected in case of a severe accident. ◀

## Automatic deactivation of the front-seat passenger airbags

The system reads if the front passenger seat is occupied by measuring the human body's resistance.

Front, knee and side airbag on the front passenger's side are either activated or deactivated.

 Leave feet in the footwell

Make sure that the front passenger keeps his or her feet in the footwell; otherwise, proper functioning of the front passenger airbag might not be assured. ◀

 Child restraint fixing system in the front passenger seat

Before transporting a child on the front passenger seat, refer to the safety notes and instructions for children on the front passenger seat, see Children. ◀

## Malfunction of the automatic deactivation system

When transporting older children and adults, the front-seat passenger airbags may be deactivated in certain sitting positions. In this case, the indicator lamp for the front-seat passenger airbags lights up.

In this case, change the sitting position so that the front-seat passenger airbags are activated and the indicator lamp goes out.

If it is not possible to activate the airbags, have the person sit in the rear.

To enable correct recognition of the occupied seat cushion

- ▷ Do not attach covers, cushions, ball mats or other items to the front passenger seat unless they are specifically recommended by your vehicle's manufacturer.
- ▷ Do not place any electronic devices on the passenger seat if a child restraint system is to be installed on it.

- ▷ Do not place objects under the seat that could press against the seat from below.
- ▷ No moisture in or on the seat.

## Indicator lamp for the front-seat passenger airbags

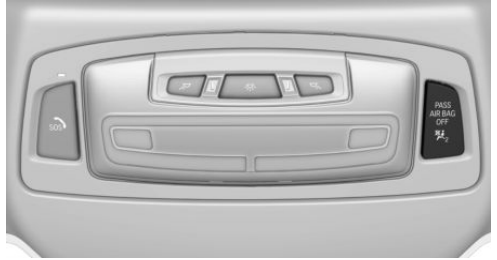

The indicator lamp for the front-seat passenger airbags indicates the operating state of the front-seat passenger airbags.

The lamp indicates whether the airbags are either activated or deactivated.



- ▷ The indicator lamp lights up when a child is properly seated in a child restraint fixing system or when the seat is empty. The airbags on the front passenger side are not activated.
- ▷ The indicator lamp does not light up when, e.g., a correctly seated person of sufficient size is detected on the seat. The airbags on the front passenger side are activated.

## Detected child seats

The system generally detects children seated in a child seat, particularly in child seats required by NHTSA when the vehicle was manufactured. After installing a child seat, make sure that the indicator lamp for the front-seat passenger airbags lights up. This indicates that the child seat has been detected and the front-seat passenger airbags are not activated.

## Strength of the driver's and front-seat passenger airbag

The explosive power that activates driver's/ front passenger's airbags very much depends on the positions of the driver's/front passenger's seat.

With a respective message appearing on Control Display calibrate the front seats to keep the accuracy of this function over the long-term.

### Calibrating the front seats

A corresponding message appears on the Control Display.

1. Press the reel and move the respective seat all the way forward.
2. Press the reel forward again. The seat still moves forward slightly.
3. Readjust the seat to the desired position.

The calibration procedure is completed when the message on the Control Display disappears.

If the message continues to be displayed, repeat the calibration.

If the message does not disappear after a repeat calibration, have the system checked as soon as possible.

-  **Unobstructed area of movement**  
Ensure that the area of movement of the seats is unobstructed to avoid personal injury or damage to objects. ◀



## Rollover protection system

### The concept

The rollover protection system is automatically activated in the event of a sufficiently serious accident or if the longitudinal axis is tilted excessively. The safety frames located behind the rear headrests extend within fractions of a second.

Supplementing the reinforced front windshield frame, the rollover protection system further increases passenger safety.

### Hints

-  Keep the movement area unobstructed
-  Always keep the movement area of the rollover protection system clear. Otherwise, there may be damage or injuries when the rollover protection system is triggered. ◀

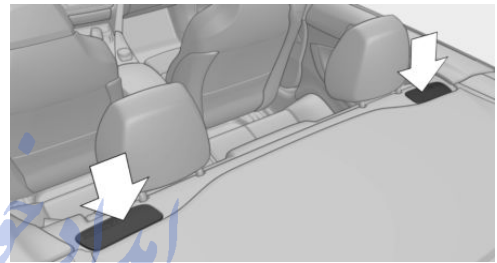



Do not place any objects on the covers of the rollover protection system.

-  In the event of malfunctions, deactivation or after deployment

Only have the airbags checked, repaired or dismantled and the system scrapped by your service center. Non-professional attempts to service the system could lead to failure in an emergency or unintentional activation of the airbag - both may lead to injury. ◀

### Triggered rollover protection system

-  After deployment or damage
-  After deployment of the rollover protection system or in the event of damage, have the system checked and replaced.

Have this work performed only by your service center; otherwise, this safety feature might not work properly. ◀



Do not move hardtop

When the rollover protection system is extended, do not move the hardtop. Otherwise, damages or injuries may result. ◀

If the rollover protection system was not placed under any stress after an automatic triggering, it can be pushed back by hand, e.g. to close the hardtop. The protective function of the system is then restored.

1. Pull the release lever in the safety frame up and hold it, arrow 1.

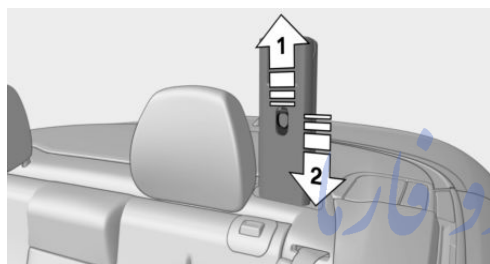

2. Push the safety frame down, arrow 2.
3. Release the release lever only if the safety frame was pushed back almost completely.
4. Push the safety frame down until it noticeably engages. To do this, the safety frame must be pressed far into its holder; high levels of force are required.



Do not bend via the safety frame

Should the safety frame not have snapped in place when it is released, then it moves back up with jerking movements. When it is released, do not bend via the safety frame; otherwise, there is a risk of injury with a safety frame that is not engaged. ◀

Slowly reduce pressure on the safety frame in order to test whether it is latched.

5. Proceed likewise with the second safety frame.

## Malfuction



A Check Control message is displayed when there is a malfunction.

## Tire Pressure Monitor TPM

### The concept

The system monitors tire inflation pressure in the four mounted tires. The system warns you if there is a significant loss of pressure in one or more tires. For this purpose, sensors in the tire valves measure the tire inflation pressure and tire temperature.

### Hints



Tire damage due to external factors

Sudden tire damage caused by external circumstances cannot be recognized in advance. ◀

With use of the system observe further information found under Tire inflation pressure, refer to page 188.

### Functional requirements

The system must have been reset with the correct tire inflation pressure; otherwise, reliable signaling of tire inflation pressure loss is not assured.

Reset the system after each adjustment of the tire inflation pressure and after every tire or wheel change.

Always use wheels with TPM electronics to ensure that the system will operate properly.

### Status display

The current status of the Tire Pressure Monitor TPM can be displayed on the Control Display, e.g., whether or not the TPM is active.

1. "Vehicle info"
2. "Vehicle status"
3. (⚠) "Tire Pressure Monitor (TPM)"



The status is displayed.

## Status control display

Tire and system status are indicated by the color of the wheels and a text message on the Control Display.

### All wheels green

System is active and will issue a warning relative to the tire inflation pressures stored during the last reset.

### One wheel is yellow

A flat tire or major drop in inflation pressure in the indicated tire.

### All wheels are yellow

A flat tire or major drop in inflation pressure in several tires.

### Wheels, gray

The system cannot detect a flat tire. Reasons for this may be:

- ▷ The system is being reset.
- ▷ Malfunction.

### Status information

The status control display additionally shows the current tire inflation pressures and possibly tire temperatures. It shows the actual values read; they may vary depending on driving style or weather conditions.

### Carry out reset

Reset the system after each adjustment of the tire inflation pressure and after every tire or wheel change.

On the Control Display and on the vehicle:

1. "Vehicle info"
2. "Vehicle status"
3.  "Perform reset"
4. Start the engine - do not drive off.

5. Reset tire inflation pressure: "Perform reset".

6. Drive away.

The tires are shown in gray and the status is displayed.

After driving faster than 19 mph/30 km/h for a short period, the set tire inflation pressures are accepted as reference values. The reset is completed automatically while driving.

After a successfully completed Reset, the wheels on the Control Display are shown in green and "Tire Pressure Monitor (TPM) active" is displayed.

You may interrupt this trip at any time. When you continue the reset resumes automatically.

### Low tire pressure message



The yellow warning lamp lights up. A Check Control message is displayed.

- ▷ There is a flat tire or a major loss in tire inflation pressure.

- ▷ No reset was performed for the system. The system therefore issues a warning based on the tire inflation pressures before the last reset.

1. Reduce your speed and stop cautiously. Avoid sudden braking and steering maneuvers.

2. Check whether the vehicle is fitted with regular tires or run-flat tires.

Run-flat tires, refer to page 196, are labeled with a circular symbol containing the letters RSC marked on the tire's sidewall.



Do not continue driving without run-flat tires

Do not continue driving if the vehicle is not equipped with run-flat tires; continued driving may result in serious accidents. ◀

A low tire inflation pressure might turn on DSC Dynamic Stability Control.

## Actions in the event of a flat tire

### Normal tires

1. Identify the damaged tire.

Do this by checking the air pressure in all four tires.

If the tire inflation pressure in all four tires is shown to be correct, it is possible that the Tire Pressure Monitor did not perform a reset. Then perform the reset.

If an identification is not possible, please contact the service center.

2. Fixing a flat tire, where applicable with the Mobility System.

### Run-flat tires

#### Maximum speed

You may continue driving with a damaged tire at speeds up to 50 mph/80 km/h.

#### Continued driving with a flat tire

If continuing to drive with a damaged tire:

1. Avoid sudden braking and steering maneuvers.
2. Do not exceed a speed of 50 mph/80 km/h.
3. Check the air pressure in all four tires at the next opportunity.

If the tire inflation pressure in all four tires is shown to be correct, it is possible that the Tire Pressure Monitor did not perform a reset. In that case, carry out a reset.

Possible driving distance with complete loss of tire inflation pressure:

The possible driving distance after a loss of tire inflation pressure depends on cargo load, driving style and road conditions.

A vehicle with an average load has a possible driving range of approx. 50 miles/80 km.

A vehicle with a damaged tire reacts differently, e.g., it has reduced lane stability during braking, a longer braking distance and different

self-steering properties. Adjust your driving style accordingly. Avoid abrupt steering maneuvers or driving over obstacles, e.g., curbs, potholes, etc.

Because the possible driving distance depends on how the vehicle is used during the trip, the actual distance may be shorter or longer depending on the driving speed, road conditions, external temperature, cargo load, etc.



Continued driving with a flat tire

Drive moderately and do not exceed a speed of 50 mph/80 km/h.

Your car handles differently when you lose tire inflation pressure, e.g., your lane stability is reduced when braking, braking distances are longer and the self-steering properties will change. ◀



Final tire failure

Vibrations or loud noises while driving can indicate the final failure of a tire. Reduce speed and stop; otherwise, pieces of the tire could come loose and cause an accident. Do not continue driving and contact your service center. ◀

### Required tire inflation pressure check message

A Check Control message is displayed in the following situations

- ▶ The system has detected a wheel change, but no reset was done.
- ▶ Inflation was not carried out according to specifications.
- ▶ The tire inflation pressure has fallen below the level of the last confirmation.

In this case:

- ▶ Check the tire pressure and correct as needed.
- ▶ Carry out a reset of the system after a tire change.

## System limits

The system does not function properly if a reset has not been carried out, e.g., a flat tire is reported though tire inflation pressures are correct.

The tire inflation pressure depends on the tire's temperature. Driving or exposure to the sun will increase the tire's temperature, thus increasing the tire inflation pressure. The tire inflation pressure is reduced when the tire temperature falls again. These circumstances may cause a warning when temperatures fall very sharply.

## Malfunction



The yellow warning lamp flashes and then lights up continuously. A Check Control message is displayed. No flat tire or loss of tire inflation pressure can be detected.

Display in the following situations:

- ▶ A wheel without TPM electronics is fitted: have the service center check it if needed.
- ▶ Malfunction: have the system checked by your service center.
- ▶ TPM was unable to complete the reset. Reset the system again.
- ▶ Interference through systems or devices with the same radio frequency: after leaving the area of the interference, the system automatically becomes active again.

## Declaration according to NHTSA/ FMVSS 138 Tire Pressure Monitoring System

Each tire, including the spare (if provided) should be checked monthly when cold and inflated to the inflation pressure recommended by the vehicle manufacturer on the vehicle placard or tire inflation pressure label. (If your vehicle has tires of a different size than the size indicated on the vehicle placard or tire inflation pressure label, you should determine the

proper tire inflation pressure for those tires.) As an added safety feature, your vehicle has been equipped with a tire pressure monitoring system (TPMS) that illuminates a low tire pressure telltale when one or more of your tires is significantly under-inflated. Accordingly, when the low tire pressure telltale illuminates, you should stop and check your tires as soon as possible, and inflate them to the proper pressure. Driving on a significantly under-inflated tire causes the tire to overheat and can lead to tire failure. Under-inflation also reduces fuel efficiency and tire tread life, and may affect the vehicle's handling and stopping ability. Please note that the TPMS is not a substitute for proper tire maintenance, and it is the driver's responsibility to maintain correct tire pressure, even if under-inflation has not reached the level to trigger illumination of the TPMS low tire pressure telltale. Your vehicle has also been equipped with a TPMS malfunction indicator to indicate when the system is not operating properly. The TPMS malfunction indicator is combined with the low tire pressure telltale. When the system detects a malfunction, the telltale will flash for approximately one minute and then remain continuously illuminated. This sequence will continue upon subsequent vehicle start-ups as long as the malfunction exists. When the malfunction indicator is illuminated, the system may not be able to detect or signal low tire pressure as intended. TPMS malfunctions may occur for a variety of reasons, including the installation of replacement or alternate tires or wheels on the vehicle that prevent the TPMS from functioning properly. Always check the TPMS malfunction telltale after replacing one or more tires or wheels on your vehicle to ensure that the replacement or alternate tires and wheels allow the TPMS to continue to function properly.

## FTM Flat Tire Monitor

### The concept

The system detects tire inflation pressure loss on the basis of rotation speed differences between the individual wheels while driving.

In the event of a tire inflation pressure loss, the diameter and therefore the rotational speed of the corresponding wheel changes. This will be detected and reported as a flat tire.

The system does not measure the actual inflation pressure in the tires.

### Functional requirements

The system must have been initialized when the tire inflation pressure was correct; otherwise, reliable flagging of a flat tire is not assured. Initialize the system after each correction of the tire inflation pressure and after every tire or wheel change.

### Status display

The current status of the Flat Tire Monitor can be displayed on the Control Display, e.g., whether or not the FTM is active.

On the Control Display:

1. "Vehicle info"
2. "Vehicle status"
3.  "Flat Tire Monitor (FTM)"

The status is displayed.

### Initialization

When initializing the once set inflation tire pressures serve as reference values in order to detect a flat tire. Initialization is started by confirming the tire inflation pressures.

Do not initialize the system when driving with snow chains.

On the Control Display:

1. "Vehicle info"
2. "Vehicle status"

3.  "Perform reset"
4. Start the engine - do not drive off.
5. Start the initialization with "Perform reset".
6. Drive away.

The initialization is completed while driving, which can be interrupted at any time.

The initialization automatically continues when driving resumes.

### Indication of a flat tire



The yellow warning lamp lights up. A Check Control message is displayed.

There is a flat tire or a major loss in tire inflation pressure.

1. Reduce your speed and stop cautiously. Avoid sudden braking and steering maneuvers.
2. Check whether the vehicle is fitted with regular tires or run-flat tires.

Run-flat tires, refer to page 196, are labeled with a circular symbol containing the letters RSC marked on the tire's sidewall.



Do not continue driving without run-flat tires

Do not continue driving if the vehicle is not equipped with run-flat tires; continued driving may result in serious accidents. ◀

When a flat tire is indicated, DSC Dynamic Stability Control is switched on if needed.

### System limits



Sudden tire damage

Sudden serious tire damage caused by external circumstances cannot be recognized in advance. ◀

A natural, even tire inflation pressure loss in all four tires will not be recognized. Therefore, check the tire inflation pressure regularly.

The system could be delayed or malfunction in the following situations:

- ▷ When the system has not been initialized.
- ▷ When driving on a snowy or slippery road surface.
- ▷ Sporty driving style: spinning traction wheels, high lateral acceleration (drifting).
- ▷ When driving with snow chains.

## Actions in the event of a flat tire

### Normal tires

1. Identify the damaged tire.

Do this by checking the air pressure in all four tires.

If the tire inflation pressure in all four tires is correct, the Flat Tire Monitor may not have been initialized. In this case, initialize the system.

If an identification is not possible, please contact the service center.

2. Fix the flat tire.

### Run-flat tires

#### Maximum speed

You may continue driving with a damaged tire at speeds up to 50 mph/80 km/h.

#### Continued driving with a flat tire

If continuing to drive with a damaged tire:

1. Avoid sudden braking and steering maneuvers.
2. Do not exceed a speed of 50 mph/80 km/h.
3. Check the air pressure in all four tires at the next opportunity.

If the tire inflation pressure in all four tires is correct, the Flat Tire Monitor may not have been initialized. In this case, initialize the system.

Possible driving distance with complete loss of tire inflation pressure:

The possible driving distance after a loss of tire inflation pressure depends on cargo load, driving style and road conditions.

A vehicle with an average load has a possible driving range of approx. 50 miles/80 km.

A vehicle with a damaged tire reacts differently, e.g., it has reduced lane stability during braking, a longer braking distance and different self-steering properties. Adjust your driving style accordingly. Avoid abrupt steering maneuvers or driving over obstacles, e.g., curbs, potholes, etc.

Because the possible driving distance depends on how the vehicle is used during the trip, the actual distance may be shorter or longer depending on the driving speed, road conditions, external temperature, cargo load, etc.



#### Continued driving with a flat tire

Drive moderately and do not exceed a speed of 50 mph/80 km/h.

Your car handles differently when you lose tire inflation pressure, e.g., your lane stability is reduced when braking, braking distances are longer and the self-steering properties will change. ◀



#### Final tire failure

Vibrations or loud noises while driving can indicate the final failure of a tire. Reduce speed and stop; otherwise, pieces of the tire could come loose and cause an accident. Do not continue driving and contact your service center. ◀

## Intelligent Safety

### The concept

Intelligent Safety enables central operation of the driver assistance system.

Depending on how the vehicle is equipped, Intelligent Safety consists of one or more systems that can help prevent a imminent collision. These systems are active automatically

every time the engine is started using the Start/Stop button:

- ▷ Front-end collision warning, refer to page 106.
- ▷ Pedestrian warning, refer to page 112.

## Note



### Personal responsibility

The system does not serve as a substitute for the driver's personal judgment of the traffic situation.

Be aware of the traffic situation and the vehicle's surroundings at all times, otherwise accidents are still possible despite all warnings. ◀

## At a glance

### Button in the vehicle



Intelligent Safety button

## Camera

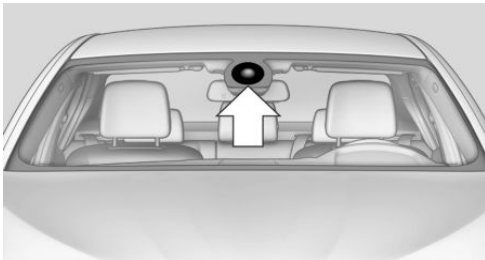

The camera is found near the interior rearview mirror.

Keep the windshield in the area behind the interior rearview mirror clean and clear.

## Switching on/off

The Intelligent Safety systems are automatically active after every departure.



Press button: the systems are turned off. The LED goes out.

Press button: the systems are turned on. The LED lights up.

Settings can be made on the Control Display.

## Front-end collision warning

Depending on the equipment, the collision warning system consists of one of the two systems:

- ▷ Front-end collision warning with City Braking function, refer to page 106.
- ▷ Front-end collision warning with braking function, refer to page 109.

## Front-end collision warning with City Braking function

### The concept

The system can help prevent accidents. If an accident cannot be prevented, the system will help reduce the collision speed.

The system sounds a warning before an imminent collision and actuates brakes independently if needed.

The automatic braking intervention is done with limited force and duration.

A camera in the area of the rearview mirror controls the system.

The front-end collision warning is available even if cruise control has been deactivated.

With the vehicle approaching another vehicle intentionally the collision warning is delayed avoiding false alarm.

## Note



**Personal responsibility**

The system does not serve as a substitute for the driver's personal judgment of the traffic situation.

Be aware of the traffic situation and the vehicle's surroundings at all times, otherwise accidents are still possible despite all warnings. ◀

## General information

The system warns at two levels of an imminent danger of collision at speeds from approx. 3 mph/5 km/h. Time of warnings may vary with the current driving situation.

Appropriate braking kicks in at speeds of up to 35 mph/60 km/h.

## Detection range

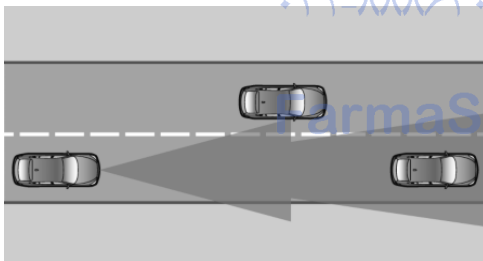

It responds to objects if they are detected by the system.

## At a glance

### Button in the vehicle



Intelligent Safety button

## Camera

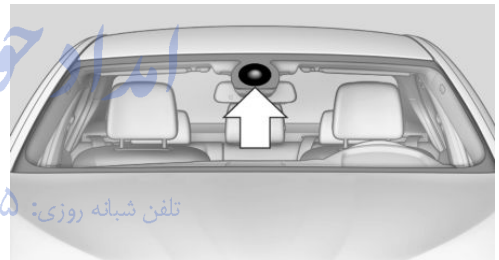

The camera is found near the interior rearview mirror.

Keep the windshield in the area behind the interior rearview mirror clean and clear.

## Switching on/off

### Switching on automatically

The system is automatically active after every driving-off.

### Switch off



Press button: the system is switched off. The LED goes out.

Re-press button: the system is switched on. The LED lights up.

## Setting the warning time

The warning time can be set via iDrive.

1. "Settings"
2. "Frontal Coll. Warning"
3. Activate the desired time on the Control Display.

The selected time is stored for the profile currently in use.

## Warning with braking function

### Note

 Adapting your speed and driving style  
The warning does not relieve the driver of the responsibility to adapt his or her driving speed and style to the traffic conditions. ◀

### Display

If a collision with a recognized vehicle is imminent a warning symbol appears in the instrument cluster and in the Head-Up Display.

| Symbol  | Measure   |
|---|---|
|   | The vehicle lights up red: prewarning.<br>Brake and increase distance.  |
|  | The vehicle flashes red and an acoustic signal sounds: acute warning.<br>You are requested to intervene by braking or make an evasive maneuver. |

### Prewarning

This warning is issued, e.g., when there is the impending danger of a collision or the distance to the vehicle ahead is too small.

The driver must intervene actively when there is a prewarning.

## Acute warning with braking function

Warning of the imminent danger of a collision when the vehicle approaches another object at a relatively high differential speed.

The driver must intervene actively when there is an acute warning. If necessary, the driver is assisted by a minor automatic braking intervention in a possible risk of collision.

Acute warnings can also be triggered without previous prewarning.

### Braking intervention

The warning prompts the driver himself/herself to react. During a warning, the maximum braking force is used. Premise for the brake booster is sufficiently quick and hard stepping on the brake pedal. The system can assist with some braking intervention if there is risk of a collision. At low speeds vehicles may thus come to a complete stop.

The braking intervention is executed only if DSC Dynamic Stability Control is switched on and Dynamic Traction Control DTC is activated.

The braking intervention can be interrupted by stepping on the accelerator pedal or by actively moving the steering wheel.

Object detection can be restricted. Limitations of the detection range and functional restrictions are to be considered.

 Tow-starting and towing

For towing the vehicle turn, switch off the Intelligent Safety systems; otherwise malfunctions of the individual braking systems might lead to accidents. ◀

### System limits

 Be alert

Due to system limitations, warnings may be not issued at all, or may be issued late or improperly. Therefore, always be alert and



ready to intervene; otherwise, there is the risk of an accident. ◀

### Detection range

The system's detection potential is limited. Thus a warning might not be issued or be issued late.

E. g. the following situations may not be detected:

- ▶ Slow moving vehicles when you approach them at high speed.
- ▶ Vehicles that suddenly swerve in front of you, or sharply decelerating vehicles.
- ▶ Vehicles with an unusual rear appearance.
- ▶ Two-wheeled vehicles ahead of you.

### Functional limitations

The system may not be fully functional in the following situations:

- ▶ In heavy fog, rain, sprayed water or snow-fall.
- ▶ In tight curves.
- ▶ If the driving stability control systems are limited or deactivated, e.g., DSC OFF.
- ▶ If, depending on the vehicle equipment version, the field of view of the camera in the mirror or the radar sensor is dirty or obscured.
- ▶ Up to 10 seconds after the start of the engine, via the Start/Stop knob.
- ▶ During calibration of the camera immediately after vehicle shipment.
- ▶ If there is constant blinding effects because of oncoming light, e.g., from the sun low in the sky.

### Warning sensitivity

The more sensitive the warning settings are, the more warnings are displayed. However, there may also be an excess of false warnings.

## Front-end collision warning with braking function

### The concept

The system can help prevent accidents. If an accident cannot be prevented, the system will help reduce the collision speed.

The system sounds a warning before an imminent collision and actuates brakes independently if needed.

The automatic braking intervention is executed with limited braking force and for a brief period only.

If the vehicle is equipped with Active Cruise Control with Stop & Go, the front-end collision warning is controlled via the cruise control radar sensor.

The front-end collision warning is available even if cruise control has been deactivated.

With the vehicle approaching another vehicle intentionally the collision warning is delayed avoiding false alarm.

### General information

The system issues a two-phase warning of a possible danger of collision with vehicles at speeds above approx. 3 mph/5 km/h. Time of warnings may vary with the current driving situation.

### Detection range

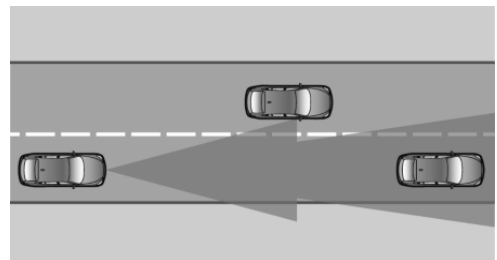

It responds to objects if they are detected by the system.

## At a glance

### Button in the vehicle



Intelligent Safety button

### Radar sensor

A radar sensor is located in the front bumper for detecting vehicles on the road ahead of the vehicle.

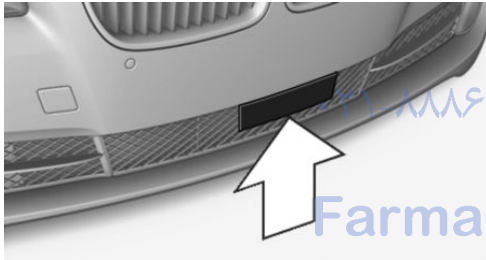

A dirty or covered sensor may prevent the detection of vehicles.

- ▷ If necessary, clean the radar sensor. Remove layers of snow and ice carefully.
- ▷ Do not cover the view field of the radar sensor.

### Switching on/off

#### Switching on automatically

The system is automatically active after every driving-off.

### Switch off



Press button: the system is switched off. The LED goes out.

Re-press button: the system is switched on. The LED lights up.

### Setting the warning time

The warning time can be set via iDrive.

1. "Settings"
2. "Frontal Coll. Warning"
3. Activate the desired time on the Control Display.

The selected time is stored for the profile currently in use.

### Warning with braking function

#### Note



Adapting your speed and driving style

The warning does not relieve the driver of the responsibility to adapt his or her driving speed and style to the traffic conditions. ◀

### Display

If a collision with a recognized vehicle is imminent a warning symbol appears in the instrument cluster and in the Head-Up Display.

| Symbol  | Measure   |
|---|---|
|  | The vehicle lights up red: prewarning.<br>Brake and increase distance.  |
|  | The vehicle flashes red and an acoustic signal sounds: acute warning.<br>You are requested to intervene by braking or make an evasive maneuver. |



## Prewarning

This warning is issued, e.g., when there is the impending danger of a collision or the distance to the vehicle ahead is too small.

The driver must intervene actively when there is a prewarning.

## Acute warning with braking function

Warning of the imminent danger of a collision when the vehicle approaches another object at a relatively high differential speed.

The driver must intervene actively when there is an acute warning. If necessary, the driver is assisted by an automatic braking intervention in a possible risk of collision.

Acute warnings can also be triggered without previous prewarning.

## Braking intervention

The detection of objects can be influenced by technical system limitations, e. g. pedestrians or stationary objects. Limitations of the detection range and functional restrictions are to be considered.

The warning prompts the driver himself/herself to react. During a warning, the maximum braking force is used. Premise for the brake booster is sufficiently quick and hard stepping on the brake pedal. The system can assist with automatic braking intervention if there is risk of a collision. The intervention can bring the vehicle to a complete stop.

The braking intervention is executed only if DSC Dynamic Stability Control is switched on and Dynamic Traction Control DTC is activated.

Above approx. 130 mph/210 km/h the braking intervention occurs as a brief braking pressure. No automatic delay occurs.

The braking intervention can be interrupted by stepping on the accelerator pedal or by actively moving the steering wheel.



## Tow-starting and towing

For towing the vehicle turn, switch off the Intelligent Safety systems; otherwise malfunctions of the individual braking systems might lead to accidents. ◀

## System limits



## Be alert

Due to system limitations, warnings may be not issued at all, or may be issued late or improperly. Therefore, always be alert and ready to intervene; otherwise, there is the risk of an accident. ◀

## Detection range

The system's detection potential is limited.

Thus a warning might not be issued or be issued late.

E. g. the following situations may not be detected:

- ▷ Slow moving vehicles when you approach them at high speed.
- ▷ Vehicles that suddenly swerve in front of you, or sharply decelerating vehicles.
- ▷ Vehicles with an unusual rear appearance.
- ▷ Two-wheeled vehicles ahead of you.
- ▷ Pedestrians.
- ▷ Stationary objects.

## Functional limitations

The system may not be fully functional in the following situations:

- ▷ In heavy fog, rain, sprayed water or snowfall.
- ▷ In tight curves.
- ▷ If the driving stability control systems are limited or deactivated, e.g., DSC OFF.
- ▷ If the radar sensor is dirty or obscured.

## Warning sensitivity

The more sensitive the warning settings are, the more warnings are displayed. However, there may also be an excess of false warnings.

## Pedestrian warning with city braking function

### The concept

The system can help prevent accidents with pedestrians.

The system issues a warning in the city driving speed area if there is imminent danger of a collision with pedestrians and includes a braking function.

The camera in the area of the rearview mirror controls the system.

### Note

#### Personal responsibility

The system does not serve as a substitute for the driver's personal judgment of the traffic situation.

Be aware of the traffic situation and the vehicle's surroundings at all times, otherwise accidents are still possible despite all warnings. ◀

### General information

In daylight the system warns of possible collisions with pedestrians at speeds from about 6 mph/10 km/h to about 35 mph/60 km/h shortly before a collision the system supports you with a braking intervention.

Under those circumstances it reacts to people who are within the detection range of the system.

## Detection range

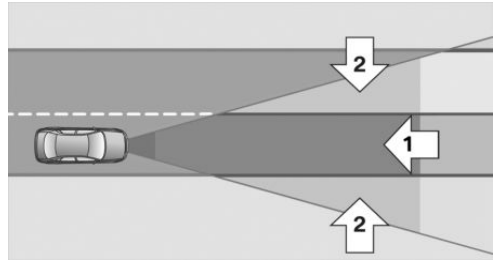

The detection area in front of the vehicle is divided into two areas.

- ▶ Central area, arrow 1, directly in front of the vehicle.
- ▶ Expanded area, arrow 2, to the right and left.

A collision is imminent if pedestrians are located within the central area. A warning is issued about pedestrians who are located within the extended area only if they are moving in the direction of the central area.

### At a glance تلفن شماره ۰۲۰۸۸۸۸۸۸۸

### Button in the vehicle



 Intelligent Safety button

## Camera

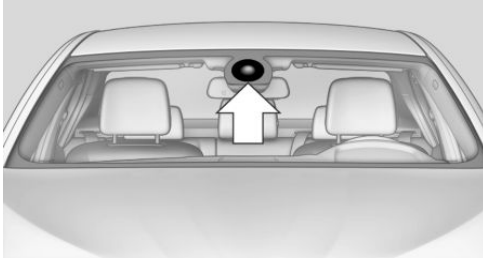

The camera is found near the interior rearview mirror.

Keep the windshield in the area behind the interior rearview mirror clean and clear.

### Switching on/off

#### Switching on automatically

The system is automatically active after every driving-off.

#### Switch off



Press button: the systems are turned off. The LED goes out.

Press button: the systems are turned on. The LED lights up.

### Warning with braking function

#### Note



Adapting your speed and driving style

The warning does not relieve the driver of the responsibility to adapt his or her driving speed and style to the traffic conditions. ◀

#### Display

If a collision with a person detected in this way is imminent, a warning symbol appears on the instrument cluster and in the Head-up Display.



The red symbol is displayed and a signal sounds.

Intervene immediately by braking or make an evasive maneuver.

### Braking intervention

The warning prompts the driver himself/herself to react. During a warning, the maximum braking force is used. Premise for the brake booster is sufficiently quick and hard stepping on the brake pedal. The system can assist with some braking intervention if there is risk of a collision. At low speeds vehicles may thus come to a complete stop.

The braking intervention is executed only if DSC Dynamic Stability Control is switched on and Dynamic Traction Control DTC is activated.

The braking intervention can be interrupted by stepping on the accelerator pedal or by actively moving the steering wheel.

Object detection can be restricted. Limitations of the detection range and functional restrictions are to be considered.



Tow-starting and towing

For towing the vehicle turn, switch off the Intelligent Safety systems; otherwise malfunctions of the individual braking systems might lead to accidents. ◀

### System limits



Be alert

Due to system limitations, warnings may be not issued at all, or may be issued late or improperly. Therefore, always be alert and ready to intervene; otherwise, there is the risk of an accident. ◀

### Detection range

The detection potential of the camera is limited.

Thus a warning might not be issued or be issued late.

E. g. the following situations may not be detected:

- ▷ Partially covered pedestrians.
- ▷ Pedestrians that are not detected as such because of the viewing angle or contour.
- ▷ Pedestrians outside of the detection range.
- ▷ Pedestrians having a body size less than 32 in/80 cm.

## Functional limitations

The system may not be fully functional or may not be available in the following situations:

- ▷ In heavy fog, rain, sprayed water or snow-fall.
- ▷ In tight curves.
- ▷ If the driving stability control systems are deactivated, e.g. DSC OFF.
- ▷ If the camera viewing field or the front windshield are dirty or covered.
- ▷ Up to 10 seconds after the start of the engine, via the Start/Stop knob.
- ▷ During calibration of the camera immediately after vehicle shipment.
- ▷ If there is constant blinding effects because of oncoming light, e.g., from the sun low in the sky.
- ▷ When it is dark outside.

## Lane departure warning

### The concept

Starting at a specific speed, this system alerts you when the vehicle on streets with lane markings is about to leave the lane. This speed, depending on the country version, is between 35 mph/55 km/h and 45 mph/70 km/h.

When switching on the system below this speed, a message is displayed in the instrument cluster.

The steering wheel begins vibrating gently in the event of warnings. The time of the warning may vary depending on the current driving situation.

The system does not provide a warning if the turn signal is set before leaving the lane.

### Hints



#### Personal responsibility

The system cannot serve as a substitute for the driver's personal judgment of the course of the road and the traffic situation.

In the event of a warning, do not jerk the steering wheel, as you may lose control of the vehicle. ◀

### At a glance

#### Button in the vehicle



Lane departure warning

### Camera

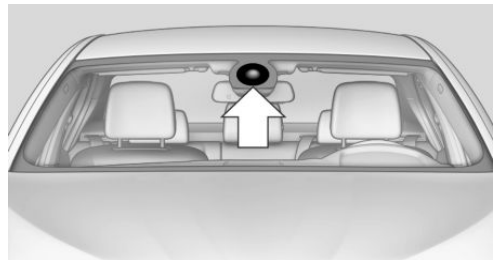

The camera is found near the interior rearview mirror.

Keep the windshield in the area behind the interior rearview mirror clean and clear.

### Switching on/off



Press button.

- ▷ On: the LED lights up.
- ▷ Off: the LED goes out.

Settings are stored for the profile currently in use.

### Display in the instrument cluster



- ▷ Lines: system is activated.
- ▷ Arrows: at least one lane marking was detected and warnings can be issued.

### Issued warning

If you leave the lane and if a lane marking has been detected, the steering wheel begins vibrating.

If the turn signal is set before changing the lane, a warning is not issued.

### End of warning

The warning ends:

- ▷ Automatically after approx. 3 seconds.
- ▷ When returning to your own lane.
- ▷ When braking hard.
- ▷ When using the turn signal.

### System limits

The system may not be fully functional in the following situations:

- ▷ In heavy fog, rain or snowfall.
- ▷ In the event of missing, worn, poorly visible, merging, diverging, or multiple lane markings such as in construction areas.
- ▷ When lane markings are covered in snow, ice, dirt or water.

- ▷ In tight curves or on narrow lanes.
- ▷ When the lane markings are covered by objects.
- ▷ When driving very close to the vehicle in front of you.
- ▷ When driving toward bright lights.
- ▷ When the windshield in front of the interior rearview mirror is fogged over, dirty or covered with stickers, etc.
- ▷ During calibration of the camera immediately after vehicle shipment.

## Active Blind Spot Detection

### The concept

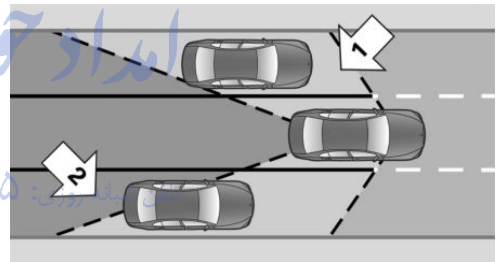

Two radar sensors below the rear bumper monitor the area behind and next to the vehicle at speeds above approx. 30 mph/50 km/h.

The system indicates whether there are vehicles in the blind spot, arrow 1, or approaching from behind on the adjacent lane, arrow 2.

The lamp in the exterior mirror housing is dimmed.

Before you change lanes after setting the turn signal, the system issues a warning in the situations described above.

The lamp in the exterior mirror housing flashes and the steering wheel vibrates.

## Hints



### Personal responsibility

The system does not serve as a substitute for the driver's personal judgment of the traffic situation.

Be aware of the traffic situation and the vehicle's surroundings at all times, otherwise accidents are still possible despite all warnings. ◀

## At a glance

### Button in the vehicle



### Active Blind Spot Detection

## Radar sensors



The radar sensors are located under the rear bumper.

## Switching on/off



Press button.

- ▷ On: the LED lights up.
- ▷ Off: the LED goes out.

The system can issue warnings at speeds above approx. 30 mph/50 km/h.

Settings are stored for the profile currently in use.

## Display

### Lamp in the exterior mirror housing

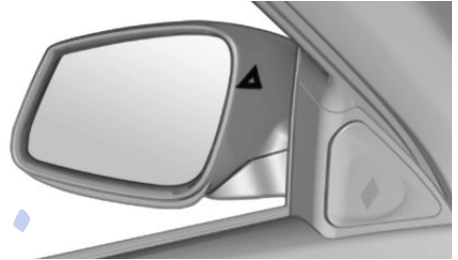

### Information stage

The dimmed lamp in the exterior mirror housing indicates when there are vehicles in the blind spot or approaching from behind.

### Warning تلفن شماره ۰۲۱-۸۸۶۲۰۸۸

If the turn signal is set while a vehicle is in the critical zone, the steering wheel vibrates briefly and the lamp in the exterior mirror housing flashes brightly.

The warning stops when the turn signal is switched off, or the other vehicle leaves the critical zone.

## System limits

The system may not be fully functional in the following situations:

- ▷ When a vehicle is approaching at a speed much faster than your own.
- ▷ In heavy fog, rain or snowfall.
- ▷ In tight curves or on narrow lanes.
- ▷ If the bumper is dirty or iced up, or covered with stickers.

A Check Control message is displayed when the system is not fully functional.



## For US owners only

The transmitter and receiver units comply with part 15 of the FCC/Federal Communication Commission regulations. Operation is governed by the following:

FCC ID:

- ▶ NBG009014A.

Compliance statement:

This device complies with part 15 of the FCC Rules. Operation is subject to the following two conditions:

- ▶ This device may not cause harmful interference, and
- ▶ this device must accept any interference received, including interference that may cause undesired operation.

Any unauthorized modifications or changes to these devices could void the user's authority to operate this equipment.

## Brake force display

### The concept



- ▶ During normal brake application, the outer brake lights light up.
- ▶ During heavy brake application, the inner brake lights light up in addition.

## Attentiveness assistant

### The concept

The system can detect increasing lack of alertness or fatigue of the driver during long, monotonous journeys, e.g., on highways. In this situation, it is recommended that the driver takes a break.

### Note



Personal responsibility

The system cannot act as a substitute for the personal assessment of one's physical state and may not detect an increasing lack of alertness or fatigue or may not detect it correctly. Therefore, make sure that the driver is rested and alert; otherwise, risks may be detected too late and an accident be caused as a result. ◀

### Function

The system is activated each time the engine is started and cannot be switched off.

After travel has begun, the system is trained about the driver, so that increasing lack of alertness or fatigue can be detected.

This procedure takes the following criteria into account:

- ▶ Personal driving style, e.g., steering behavior.
- ▶ Driving conditions, e.g., length of trip.

Starting at approximately 43 mph/70 km/h, the system is active and can display a recommendation to take a break.

### Break recommendation

If the driver becomes increasingly less alert or fatigued, a message is displayed in the Control Display with the recommendation to take a break.

A recommendation to take a break is displayed only once during an uninterrupted trip.

After a break, another recommendation to take a break cannot be displayed until after approximately 45 minutes.

### System limits

The function may be limited in the following situations, for instance, and will either output an incorrect warning or no warning at all:

- ▷ When the clock is set incorrectly.
- ▷ When the vehicle speed is mainly below about 43 mph/70 km/h.
- ▷ With a sporty driving style, such as during rapid acceleration or when cornering fast.
- ▷ In active driving situations, such as when changing lanes frequently.
- ▷ When the road surface is poor.
- ▷ In the event of strong side winds.

امداد خودرو فارما

تلفن شبانه روزی: ۰۲۱-۸۸۸۶۲۰۸۵

FarmaSOS.com

# Driving stability control systems

## Vehicle features and options

This chapter describes all standard, country-specific and optional features offered with the series. It also describes features that are not necessarily available in your car, e. g., due to the selected options or country versions. This also applies to safety-related functions and systems.

## Antilock Brake System ABS

ABS prevents locking of the wheels during braking.

The vehicle contains its steering power even during full brake applications, thus increasing active safety.

ABS is operational every time you start the engine.

## Brake assistant

When you apply the brakes rapidly, this system automatically produces the greatest possible braking force boost. It reduces the braking distance to a minimum during emergency stop. This system utilizes all of the benefits provided by ABS.

Do not reduce the pressure on the brake pedal for the duration of the emergency stop.

## DSC Dynamic Stability Control

### The concept

DSC prevents traction loss in the power wheels when driving off and accelerating.

DSC also recognizes unstable vehicle conditions such as fishtailing or nose-diving. Within

the physical limits DSC helps to keep the vehicle on a steady course by reducing engine speed and by applying brakes to the individual wheels.

### Note



Adjust your driving style to the situation. An appropriate driving style is always the responsibility of the driver.

The laws of physics cannot be repealed, not even with DSC.

Therefore, do not reduce the additional safety margin by driving in a risky manner. ◀



Do not deactivate DSC when driving with roof load.

Do not deactivate Dynamic Stability Control DSC when driving with roof load, e.g. roof-mounted luggage rack.

Otherwise, driving safety is not given in driving-critical situation due to the elevated center of gravity. ◀

### At a glance

### Button in the vehicle



DSC OFF button

## Indicator/warning lights



The indicator lamp flashes: DSC controls the drive and braking forces.

The indicator lamp lights up: DSC has failed.

## Deactivating DSC: DSC OFF

When DSC is deactivated, driving stability is reduced during acceleration and when driving in curves.

To increase vehicle stability, activate DSC again as soon as possible.

## Deactivating DSC



Press and hold this button but not longer than approx. 10 seconds, until the indicator lamp for DSC OFF lights up in the instrument cluster and displays DSC OFF.

The DSC system is switched off.

The steering and, depending on the equipment, suspension are tuned for sporty driving.

## Activating DSC



Press button.

DSC OFF and the DSC OFF indicator lamp go out.

## Indicator/warning lights

When DSC is deactivated, DSC OFF is displayed in the instrument cluster.



The indicator lamp lights up: DSC is deactivated.

## DTC Dynamic Traction Control

### The concept

The DTC system is a version of the DSC where forward momentum is optimized.

The system ensures maximum headway on special road conditions or loose road surfaces, e.g., unplowed snowy roads, but with somewhat limited driving stability.

Activating the Dynamic Traction Control DTC provides maximum traction. Driving stability is limited during acceleration and when driving in curves.

Therefore drive with appropriate caution.

You may find it useful to briefly activate DTC under the following special circumstances:

- ▷ When driving in slush or on uncleared, snow-covered roads.
- ▷ When freeing vehicle from deep snow or driving off from loose grounds.
- ▷ When driving with snow chains.

## Deactivating/activating DTC Dynamic Traction Control

### Activating DTC



Press button.

TRACTION is displayed in the instrument cluster and the indicator lamp for DSC OFF lights up.

### Deactivating DTC



Press button again.

TRACTION and the DSC OFF indicator lamp go out.

## xDrive

xDrive is the all-wheel-drive system of your vehicle. Concerted action by the xDrive and DSC further optimize traction and driving dynamics. The xDrive all-wheel-drive system variably distributes the drive forces to the front and rear axles as demanded by the driving situation and road surface.

## Dynamic Damping Control

### The concept

This system reduces undesirable vehicle motion when using a dynamic driving style or traveling on uneven road surfaces.

The system enhances driving dynamics and comfort fitting road surface and driving style.

### Programs

The system offers several different programs.

Select the programs via the Driving Dynamics Control, refer to page 121.

### SPORT

Consistently sporty control of the shock absorbers for greater driving agility.

### SPORT+

Consistently sporty control of the shock absorbers for greater driving agility when driving with limited driving stabilization.

### COMFORT/ECO PRO

Balanced control of the vehicle.

## Variable sport steering

The variable sport steering increases the steering angle of the front wheels at large steering wheel angles, e.g., in tight curves or when parking. Steering becomes more direct.

It also varies the force required to turn the wheels in accordance with the vehicle speed.

This results in a sporty steering response. In addition, it becomes easier to steer during parking and maneuvering.

## Driving Dynamics Control

### The concept



The Driving Dynamics Control helps to fine-tune the vehicle's settings and features. Various programs can be selected for this purpose. The Driving Dynamics Control and the DSC OFF buttons can each be used to activate a program.

### At a glance

### Button in the vehicle



### Operating the programs

| Press button  | Program                               |
|---|---------------------------------------|
|    | DSC OFF<br>TRACTION                   |
|  | SPORT+<br>SPORT<br>COMFORT<br>ECO PRO |

### Automatic program change

The system may automatically reel to COMFORT in the following situations:

- ▶ Failure of Dynamic Damping Control.
- ▶ Failure of DSC Dynamic Stability Control.
- ▶ The vehicle has a flat tire.
- ▶ When activating cruise control in TRACTION or DSC OFF mode.

## DSC OFF

When DSC OFF, refer to page 120, is active, driving stability is limited during acceleration and when driving in curves.

## TRACTION

When TRACTION is active, the vehicle has maximum traction on loose road surfaces. DTC Dynamic Traction Control, refer to page 120, is activated. Driving stability is limited during acceleration and when driving in curves.

## SPORT+

Sporty driving with optimized suspension and adapted engine control with limited driving stabilization.

Dynamic Traction Control is switched on.

The driver handles several of the stabilization tasks.

## Activating SPORT+



Press button repeatedly until SPORT+ appears in the instrument cluster and the DSC OFF indicator lamp lights up.

## Automatic program change

When activating cruise control, the program automatically switches to SPORT mode.

## Indicator/warning lights

SPORT+ is displayed in the instrument cluster.



The DSC OFF indicator lamp lights up: Dynamic Traction Control is activated.

## SPORT

Depending on the equipment, consistently sporty tuning of the suspension, steering, and engine control for greater driving agility with maximum driving stabilization.

The program can be configured to individual specifications. The configuration is stored for the profile currently in use.

## Activating SPORT



Press button repeatedly until SPORT is displayed in the instrument cluster.

## Configuring SPORT

When the display is activated on the Control Display, refer to page 123, the SPORT driving mode can be set to individual specifications.

- ▷ Activating SPORT.
- ▷ "Configure SPORT"
- ▷ Configuring the SPORT driving mode.

SPORT can also be configured before it is activated:

1. "Settings"
2. "Driving mode"
3. "Configure SPORT"
4. Configure driving mode.

This configuration is retrieved when the SPORT driving mode is activated.

## COMFORT

For a balanced tuning with maximum driving stabilization.

## Activating COMFORT



Press button repeatedly until COMFORT is displayed in the instrument cluster.

In certain situations, the system automatically changes to the NORMAL program, automatic program change, refer to page 121.

## ECO PRO

ECO PRO, refer to page 175, provides consistent tuning to minimize fuel consumption for maximum range with maximum driving stabilization.

Comfort functions and the engine controller are adjusted.

The program can be configured to individual specifications.

## Activating ECO PRO



Press button repeatedly until ECO PRO is displayed in the instrument cluster.

## Configuring ECO PRO

1. Activate ECO PRO.
2. "Configure ECO PRO"

Make the desired settings.

## Configuring driving program

Settings can be made for the following driving programs in Driving mode:

- ▷ SPORT, refer to page 122.
- ▷ ECO PRO, refer to page 176.

## Displays

### Program selection

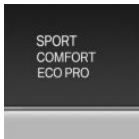

Pressing the button displays a list of the selectable programs. Depending on your vehicle's optional features, the list in the instrument cluster can differ from the illustration shown.

### Selected program

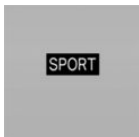

The instrument cluster displays the selected program.

## Display on the Control Display

Program changes can be displayed on the Control Display.

1. "Settings"
2. "Driving mode"

3. "Driving mode info"

## Drive-off assistant

This system supports driving off on inclines. The parking brake is not required.

1. Hold the vehicle in place with the foot brake.
2. Release the foot brake and drive off without delay.

After the foot brake is released, the vehicle is held in place for approx. 2 seconds.

For vehicles with respective equipment versions, the possible holding duration amounts to 2 minutes.

Depending on the vehicle load or when a trailer is used, the vehicle may roll back slightly.



Driving off without delay

After releasing the foot brake, start driving without delay, since the drive-off assistant will not hold the vehicle in place for more than approx. 2 seconds and the vehicle will begin to roll back. ◀

## Servotronic

### The concept

The Servotronic varies the steering force required to turn the wheels in accordance with the vehicle speed. At low speeds, the steering force is strongly supported, i. e. during steering, low force is required. As the speed increases, the assistance of the steering force is reduced.

Furthermore, the steering force adapts according to the driving program, so that a direct, sporty feel and/or comfortable steering is conveyed.

# Driving comfort

## Vehicle features and options

This chapter describes all standard, country-specific and optional features offered with the series. It also describes features that are not necessarily available in your car, e. g., due to the selected options or country versions. This also applies to safety-related functions and systems.

## Active Cruise Control with Stop & Go function, ACC

### The concept

Use this system to select a desired speed that the vehicle will maintain automatically on clear roads.

To the extent possible, the system automatically adjusts the speed to a slower vehicle ahead of you.

The distance that the vehicle maintains to the vehicle ahead of you can be varied.

For safety reasons, it depends on the speed.

To maintain a certain distance, the system automatically reduces the speed, applies the brakes lightly, or accelerates again if the vehicle ahead begins moving faster.

If the vehicle ahead of you brakes to a halt, and then proceeds to drive again within a brief period, the system is able to detect this within the given system limits. Your own vehicle will brake automatically and then accelerate again.

If the vehicle ahead of you drives away again after a prolonged period, briefly press the accelerator pedal or press the appropriate button to reactivate the system. The vehicle will automatically accelerate.

As soon as the road is clear, the vehicle accelerates to the desired speed.

The speed is also maintained downhill, but may not be maintained uphill if engine power is insufficient.

### General information

Depending on the driving settings, the features of the cruise control can change in certain areas.

### Hints



Personal responsibility

Even an active system holds the driver responsible for his or her driving, particularly for staying in your lane, adjusting your speed, keeping your distance and for your driving style all in relation to traffic.

Technically the system has its limits, it cannot independently react to all traffic situations.

Monitor your driving, be on the alert, observe the vehicle surroundings and other traffic and react when needed, e.g. through braking, steering or make evasive maneuvers - risk of accident. ◀



Unfavorable weather conditions

In the event of unfavorable weather and light conditions, e. g. if there is rain, snowfall, slush, fog or glare, this may result in poorer recognition of vehicles as well as short-term interruptions for vehicles that are already detected. Drive attentively, and react to the current traffic situation. Intervene actively when necessary, e.g., by braking, steering or making an evasive maneuver, otherwise, there is the risk of an accident. ◀



Before leaving the vehicle, secure it against moving on its own.







Before leaving the vehicle with the engine running: set the parking brake and ensure that the



Steptronic transmission is in position P. Otherwise, the vehicle may begin to move. ◀

## At a glance

### Buttons on the steering wheel

| Press button   | Function   |
|--|--|
|  | System on/off, interrupt, refer to page 125                      |
|  | Storing the speed, maintaining, refer to page 126                |
|  | Resume speed, refer to page 127                                  |
|  | Reduce distance, refer to page 127                               |
|  | Increase distance, refer to page 127                             |
|  | Rocker reel:<br>Maintain, store, change speed, refer to page 126 |

Buttons are arranged according to vehicle's series, optional features and country specifications.

### Radar sensor

A radar sensor is located in the front bumper for detecting vehicles on the road ahead of the vehicle.

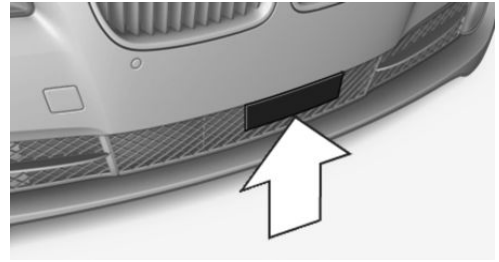

A dirty or covered sensor may prevent the detection of vehicles.

- ▷ If necessary, clean the radar sensor. Remove layers of snow and ice carefully.
- ▷ Do not cover the view field of the radar sensor.

### Switching on/off and interrupting cruise control

#### Switching on



Press button on the steering wheel.

The indicator lights in the instrument cluster light up and the mark in the speedometer is set to the current speed.

Cruise control can be used.

#### Switch off



Deactivated or interrupted system

With deactivated or interrupted system use your brakes, steering and moves as usual to avoid the chance of an accident. ◀

To switch off the system while standing, step on brake pedal at the same time.



Press button.

- ▷ If active: press twice.
- ▷ If interrupted: press once.

The displays go out. The stored desired speed and distance are deleted.

## Interrupting



When active, press the button.

If interrupting the system while stationary, press on the brake pedal at the same time.

The system is automatically interrupted in the following situations:

- ▷ When the brakes are applied.
- ▷ When drive mode D is removed.
- ▷ When DTC Dynamic Traction Control is activated or DSC is deactivated.
- ▷ When DSC is actively controlling stability.
- ▷ When SPORT+ is activated with Driving Dynamics Control.
- ▷ If the safety belt and the driver's door are opened while the vehicle is standing still.
- ▷ If the system has not detected objects for an extended period, e.g., on a road with very little traffic without curb or shoulder markings.
- ▷ If the detection range of the radar is disrupted, e.g., by dirt or heavy fog.

## Maintaining, storing, and changing the speed

### Hints



Adjusting the desired speed

Modify desired speed to road conditions and be ready to brake at all times; otherwise, there is the risk of an accident. ◀



Differences in speed

Large differences in speed relative to vehicles ahead of the vehicle cannot be compensated by the system for example in the following situations:

- ▷ When fast approaching a slowly moving vehicle.
- ▷ When another vehicle suddenly swerves into the wrong lane. ◀

## Maintaining/storing the speed



Press button.

Or:

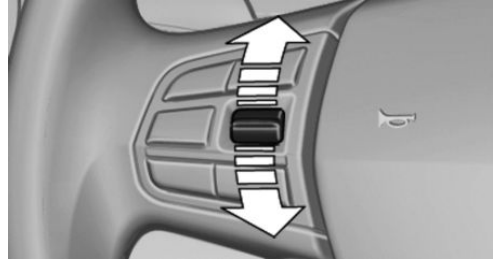

Press the rocker reel while the system is interrupted.

When the system is switched on, the current speed is maintained and stored as the desired speed.

This is displayed in the speedometer and briefly in the instrument cluster. Displays in the instrument cluster, refer to page 127.

When cruise control is maintained or stored, DSC Dynamic Stability Control will be turned on if needed.

### Changing the speed

Press the rocker reel up or down repeatedly until the desired speed is set.

If active, the displayed speed is stored and the vehicle reaches the stored speed when the road is clear.

- ▷ Each time the rocker reel is pressed to the point of resistance, the desired speed increases or decreases by approx. 1 mph/1 km/h.
- ▷ Each time the rocker reel is pressed past the point of resistance, the desired speed increases or decreases by a maximum of 5 mph/10 km/h.

Hold the rocker reel in position to repeat the action.

## Distance



Select a distance

Adjust the distance according to the traffic and weather conditions; otherwise, there is the risk of an accident. Maintain the prescribed safety distance. ◀

## Reduce distance



Press button repeatedly until the desired distance is set.

Instrument cluster will display selected distance, refer to page 127.

## Increase distance



Press button repeatedly until the desired distance is set.

Instrument cluster will display selected distance, refer to page 127.

## Calling up the desired speed and distance

### While driving



Press button with the system switched on.

In the following cases, the stored speed value is deleted and cannot be called up again:

- ▷ When the system is switched off.
- ▷ When the ignition is switched off.

### While standing

The system brought the vehicle to a complete standstill:

- ▷ Green marking in the speedometer:  
Your vehicle accelerates automatically as soon as the vehicle in the range of the radar sensor moves off.
- ▷ Speedometer markings turn orange: no automatic driving off.

To accelerate to the desired speed automatically, press the accelerator or press the RES or SET button.

Rolling bars in the distance display indicate that the the vehicle detected by the radar sensor has driven off.

Your vehicle was brought down to a halt through stepping on the brake pedal and it is standing behind another vehicle:

1.  Press button to call up a stored desired speed.
2. Release the brake pedal.
3. Step on the accelerator briefly, or press the RES rocker reel when the vehicle ahead of you drives away.

## Displays in the instrument cluster

### Desired speed



▷ The marking lights up green: the system is active.

▷ The marking lights up orange: the system has been interrupted.

▷ The marking does not light up: the system is switched off.

### Brief status display



Selected desired speed.

If --- appears briefly on the display for Check Control messages, it is possible that the system requirements are currently not ready for operations.

### Distance to vehicle ahead of you

Shown is selected distance to the vehicle driving ahead of you.

## Distance display



Distance 1



Distance 2



Distance 3



Distance 4

This value is set after the system is switched on.



The system has been interrupted or distance control is temporarily suppressed because the accelerator pedal is being pressed; a vehicle was not detected.



Distance control is temporarily suppressed because the accelerator pedal is being pressed; a vehicle was detected.

Rolling bars: the detected vehicle has driven away.

ACC is no longer accelerating. To accelerate further, activate ACC by briefly stepping on the accelerator pedal, pressing the RES button or rocker reel.

The conditions are not adequate for the system to work.

The system was deactivated but applies the brakes until you actively resume control by pressing on the brake pedal or accelerator pedal.



The vehicle symbol flashes red and an acoustic signal sounds:

You are requested to intervene by braking or make an evasive maneuver.

## Displays in the Head-up Display

Some system information can also be displayed in the Head-up Display.

## System limits

## Speed range

The system is best used on well-constructed roads.

The minimum speed that can be set is 20 mph/30 km/h. The maximum speed that can be set depends on the vehicle.

The system can also be activated when stationary.

Comply with the legal speed limit in every situation when using the system.

## Detection range

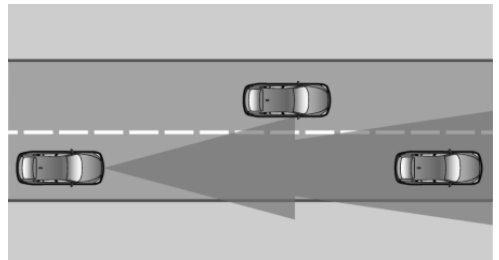

The detection capability of the system and the automatic braking capability are limited.

Two-wheeled vehicles driving ahead of you for instance might not be detected.

## Indicator/warning lights



Personal responsibility

The indicator and warning lights do not relieve the driver of the responsibility to adapt his or her desired driving speed and style to the traffic conditions. ◀



The vehicle symbol lights up orange:

A vehicle has been detected ahead of you.



The vehicle symbol flashes orange:

**Limited detection potential**

Because of the limited possible detection, you should be alert at all times so that you can intervene if needed; otherwise, there is the risk of an accident. ◀

**Deceleration**

The system does not decelerate when a stationary obstacle is located in the same lane, e.g., a vehicle at a red traffic light or at the end of traffic congestion.

The system also does not respond to:

- ▶ Pedestrians or similar slow-moving road users.
- ▶ Red traffic lights.
- ▶ Stationary objects.
- ▶ Cross traffic.
- ▶ Oncoming traffic.

**No warnings**

A warning may not be issued when approaching a stationary or very slow-moving obstacle. You must react yourself; otherwise, there is the risk of an accident. ◀

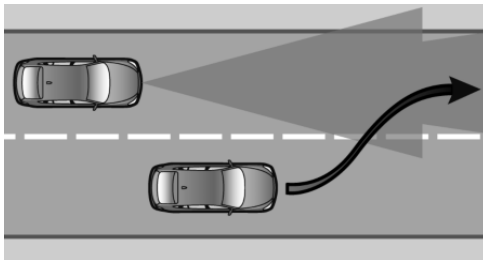
**Swerving vehicles**

A vehicle driving in front of you is not detected until it is completely within the same lane as your vehicle.

**Swerving vehicles**

If a vehicle driving ahead of you suddenly swerves into your lane, the system may not be able to automatically restore the selected dis-

tance. This also applies to major speed differences to vehicles driving ahead of you, e.g., when rapidly approaching a truck. When a vehicle driving ahead of you is reliably detected, the system requests that the driver intervene by braking and carrying out evasive maneuvers, if needed. You must react yourself; otherwise, there is the risk of an accident. ◀

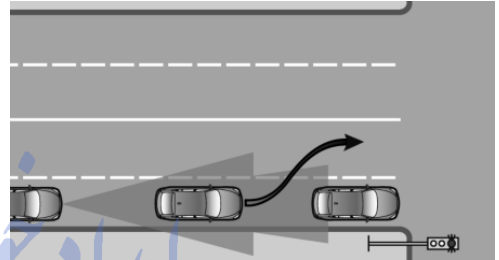
**Unexpected lane change**

If a vehicle ahead of you unexpectedly moves into another lane from behind a stopped vehicle, you yourself must react, as the system does not react to stopped vehicles.

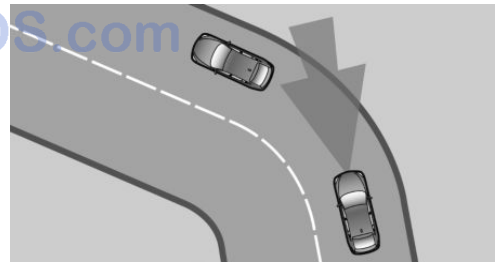
**Cornering**

If the desired speed is too high for a curve, the speed is reduced slightly, although curves cannot be anticipated in advance. Therefore, drive into a curve at an appropriate speed.

In tight curves the system offers only restricted detection where a vehicle ahead of you might be detected late or not at all.

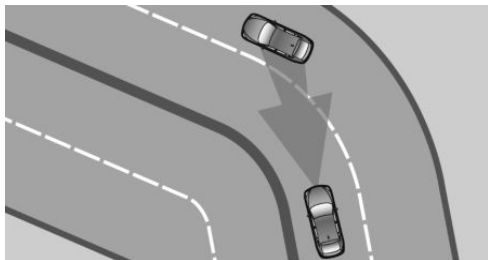

When you approach a curve the system may briefly report vehicles in the next lane due to the bend of the curve. If the system decelerates you may compensate it by briefly accelerating.

After releasing the gas pedal the system is reactivated and controls speed independently.

### Driving away

In some situations, the vehicle cannot drive off automatically; for example:

- ▷ On steep inclines.
- ▷ From behind bumps in the road.

In these cases, step on the accelerator pedal.

### Radar sensor

#### For US owners only

The transmitter and receiver units comply with part 15 of the FCC/Federal Communication Commission regulations. Operation is governed by the following:

FCC ID:

- ▷ OAYARS3-A

Compliance statement:

This device complies with part 15 of the FCC Rules. Operation is subject to the following two conditions:

- ▷ This device may not cause harmful interference, and
- ▷ this device must accept any interference received, including interference that may cause undesired operation.

Any unauthorized modifications or changes to these devices could void the user's authority to operate this equipment.

### Malfunction

The system cannot be activated if the radar sensor is not aligned correctly. This may be caused by damage incurred during parking, e.g.

A Check Control message is displayed if the system fails.

## Cruise control

### The concept

The system maintains a preset speed via the buttons on the steering wheel. The system brakes on downhill gradients if engine braking is insufficient.

### General information

Depending on the driving settings, the features of the cruise control can change in certain areas.

### Hints



Unfavorable conditions





Do not use the system if unfavorable conditions make it impossible to drive at a constant speed, e.g.:

- ▷ On winding roads.
- ▷ In heavy traffic.
- ▷ On slippery roads, in fog, snow or rain, or on a loose road surface.

Otherwise, you could lose control of the vehicle and cause an accident. ◀

## At a glance

### Buttons on the steering wheel

| Press button   | Function                               |
|--|--|
|  | System on/off, interrupt               |
|  | Store speed                            |
|  | Resume speed                           |
|  | Rocker reel: change, hold, store speed |

## Controls

### Switching on

 Press button on the steering wheel.

The marking in the speedometer is set to the current speed.

Cruise control can be used.

### Switch off

 Deactivated or interrupted system  
With deactivated or interrupted system use your brakes, steering and moves as usual to avoid the chance of an accident. ◀

 Press button.

- ▷ If active: press twice.
- ▷ If interrupted: press once.

The displays go out. The stored desired speed is deleted.

### Interrupting

 When active, press the button.

The system is automatically interrupted if:

- ▷ The brakes are applied.

- ▷ The clutch pedal is depressed for a few seconds or released while a gear is not engaged.
- ▷ The gear engaged is too high for the current speed.
- ▷ Selector lever position D is disengaged.
- ▷ DTC Dynamic Traction Control is activated or DSC is deactivated.
- ▷ DSC is actively controlling stability.
- ▷ When SPORT+ is activated with Driving Dynamics Control.

## Maintaining, storing, and changing the speed

### Hints

 Adjusting the desired speed  
Modify desired speed to road conditions and be ready to brake at all times; otherwise, there is the risk of an accident. ◀

### Maintaining/storing the speed

 Press button.  
Or:

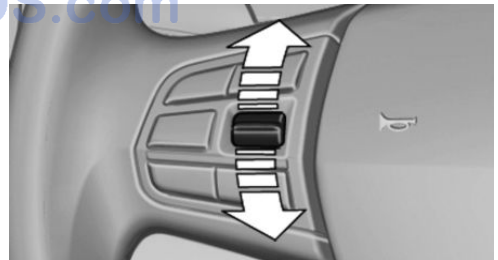

Press the rocker reel while the system is interrupted.

When the system is switched on, the current speed is maintained and stored as the desired speed.

This is displayed, refer to page 132, in the speedometer and briefly in the instrument cluster.

When cruise control is maintained or stored, DSC Dynamic Stability Control will be turned on if needed.

### Changing the speed

Press the rocker reel up or down repeatedly until the desired speed is set.

If active, the displayed speed is stored and the vehicle reaches the stored speed when the road is clear.

- ▷ Each time the rocker reel is pressed to the point of resistance, the desired speed increases or decreases by approx. 1 mph/1 km/h.
- ▷ Each time the rocker reel is pressed past the point of resistance, the desired speed increases or decreases by a maximum of 5 mph/10 km/h.

The maximum speed that can be set depends on the vehicle.

- ▷ Pressing the rocker reel to the resistance point and holding it accelerates or decelerates the vehicle without requiring pressure on the accelerator pedal.

After the rocker reel is released, the vehicle maintains its final speed. Pressing the reel beyond the resistance point causes the vehicle to accelerate more rapidly.

### Resuming the desired speed

 Press button.

The stored speed is reached and maintained.

### Displays in the instrument cluster

#### Indicator lamp



Depending on how the vehicle is equipped, the indicator lamp in the instrument cluster indicates whether the system is switched on.

### Desired speed



- ▷ The marking lights up green: the system is active.
- ▷ The marking lights up orange: the system has been interrupted.
- ▷ The marking does not light up: the system is switched off.

### Brief status display



Selected desired speed.

If --- appears briefly on the display for Check Control messages, it is possible that the system requirements are currently not ready for operations.

### Displays in the Head-up Display

Some system information can also be displayed in the Head-up Display.

### PDC Park Distance Control

#### The concept

PDC is a support when parking. When you slowly approach an object in the rear - or also in the front of the vehicle if the feature is available - then the object is reported through:

- ▷ Signal tones.
- ▷ Visual display.

#### General information

Ultrasound sensors in the bumpers measure the distances from objects.

The maneuvering range, depending on the obstacle and environmental conditions, is approx. 6 ft/2 m.

An acoustic warning is first given:

- ▷ By the front sensors and the two rear corner sensors at approx. 24 in/60 cm.



- ▷ By the rear middle sensors at approx. 5 ft/1.50 m.

To ensure full functionality:

- ▷ Do not cover sensors, e.g., with stickers, bicycle racks and the like.
- ▷ Keep the sensors clean and free of ice.
- ▷ When using high-pressure washers, do not spray the sensors for long periods and maintain a distance of at least 12 in/30 cm.

## Hints



### Personal responsibility

Even an active system does not relieve the driver from personal responsibility while driving.

Technically the system has its limits, it cannot independently react to all traffic situations.

Monitor your driving, be on the alert, observe the vehicle surroundings and other traffic and react when needed - risk of accident. ◀



### Avoid driving fast with PDC

Avoid approaching an object too fast.

Avoid driving off fast while PDC is not yet active.

For technical reasons, the system may otherwise be too late in issuing a warning. ◀

## At a glance

### With front PDC: button in vehicle



### PDC Park Distance Control

## Switching on/off

### Switching on automatically

With the engine running, engage lever in position P R.

### Automatic deactivation during forward travel

The system switches off when a certain driving distance or speed is exceeded.

Switch the system back on if needed.

### With front PDC: switching on/off manually



Press button.

- ▷ On: the LED lights up.
- ▷ Off: the LED goes out.

## Display

### Signal tones

When approaching an object, an intermittent sound indicates the position of the object. E. g. if an object is detected to the left rear of the vehicle, a signal tone sounds from the left rear speaker.

The shorter the distance to the object, the shorter the intervals.

If the distance to a detected object is less than approx. 10 in/25 cm, a continuous tone is sounded.

With front PDC: if objects are located both in front of and behind the vehicle, an alternating continuous signal is sounded.

The signal tone is switched off:

- ▷ When the vehicle moves away from an object by more than approx. 4 in/10 cm.
- ▷ When selector lever position P is engaged on vehicles with Steptronic transmission.

## Volume

The volume of the PDC signal tone can be adjusted similar to the sound and volume settings of the radio.

Settings are stored for the profile currently in use.

## Visual warning

The approach of the vehicle to an object can be shown on the Control Display. Objects that are farther away are already displayed on the Control Display before a signal sounds.

A display appears as soon as Park Distance Control (PDC) is activated.

The range of the sensors is represented in the colors green, yellow and red.

When the image of the rearview camera is displayed, the reel can be made to PDC:

 "Rear view camera"

## System limits

### Limits of ultrasonic measurement

Ultrasonic measuring might not function under the following circumstances:

- ▷ For small children and animals.
- ▷ For persons with certain clothing, e.g. coats.
- ▷ With external interference of the ultrasound, e.g. from passing vehicles or loud machines.
- ▷ When sensors are dirty, iced over, damaged or out of position.
- ▷ Under certain weather conditions such as high relative humidity, rain, snowfall, extreme heat or strong wind.
- ▷ With tow bars and trailer couplings of other vehicles.
- ▷ With thin or wedge-shaped objects.
- ▷ With moving objects.

- ▷ With elevated, protruding objects such as ledges or cargo.
- ▷ With objects with corners and sharp edges.
- ▷ With objects with a fine surface structure such as fences.
- ▷ For objects with porous surfaces.

Low objects already displayed, e.g., curbs, can move into the blind area of the sensors before or after a continuous tone sounds.

### False warnings

PDC may issue a warning under the following conditions even though there is no obstacle within the detection range:

- ▷ In heavy rain.
- ▷ When sensors are very dirty or covered with ice.
- ▷ When sensors are covered in snow.
- ▷ On rough road surfaces.
- ▷ On uneven surfaces, such as speed bumps.
- ▷ In large buildings with right angles and smooth walls, e.g., in underground garages.

- ▷ Through heavy pollution.
- ▷ Due to other ultrasound sources, e.g., sweeping machines, high pressure steam cleaners or neon lights.

The malfunction is signaled by a continuous tone alternating between the front and rear speakers. As soon as the malfunction due to other ultrasound sources is no longer present, the system is again fully functional.

### Malfunction

A Check Control message is displayed.

The range of the sensors is shown as a shaded area on the Control Display.

PDC has failed. Have the system checked.

To ensure full functionality:

- Keep the sensors clean and free of ice.
- dimmedDo not put any stickers on sensors.
- When using high-pressure washers, do not spray the sensors for long periods and maintain a distance of at least 12 in/30 cm.

## Surround View

### The concept

Surround View comprises various camera assistance systems that help the driver when parking, maneuvering, and at complex exits and intersections.

- Rearview camera, refer to page 135
- Side View, refer to page 137.
- Top View, refer to page 138.

## Rearview camera

### The concept

The rearview camera provides assistance in parking and maneuvering backwards. The area behind the vehicle is shown on the Control Display.

### Hints



Check the traffic situation as well

Check the traffic situation around the vehicle with your own eyes. Otherwise, an accident could result from road users or objects that are not lidtured by the camera. ◀

## At a glance

### Button in the vehicle



Rearview camera

### Camera

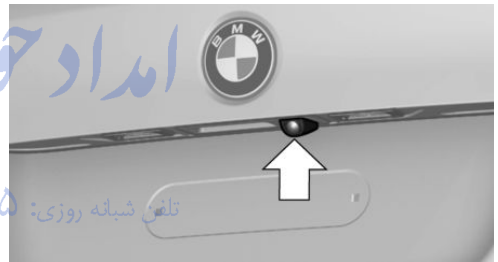

The camera lens is located in the handle of the trunk lid. The image quality may be impaired by dirt.

Clean the lens, refer to page 223.

## Switching on/off

### Switching on automatically

With the engine running, engage lever in position P R.

The rearview camera image is displayed if the system was switched on via the iDrive.

### Automatic deactivation during forward travel

The system switches off when a certain driving distance or speed is exceeded.

Switch the system back on if needed.

## Switching on/off manually



Press button.

- ▷ On: the LED lights up.
- ▷ Off: the LED goes out.

The PDC is shown on the Control Display.

## Switching the view via iDrive

With PDC activated or Top View switched on:

 "Rear view camera"

The rearview camera image is displayed.



## Display on the Control Display

### Functional requirement

- ▷ The rearview camera is switched on.
- ▷ The trunk lid is fully closed.

## Activating assistance functions

More than one assistance function can be active at the same time.

- ▷ Parking aid lines
  -  "Parking aid lines"
  - Lanes and turning radius are indicated.
- ▷ Obstacle marking
  -  "Obstacle marking"
  - Spatially-shaped markings are displayed.

## Pathway lines

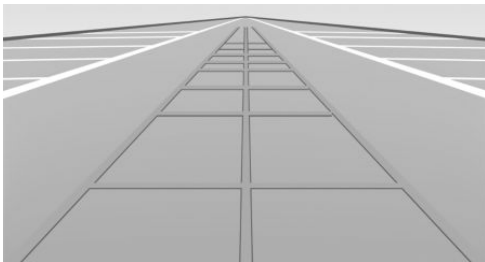

- ▷ Pathway lines can be superimposed on the image of the rearview camera.

- ▷ They help you to estimate how much space is needed when parking and maneuvering on level pavement.
- ▷ They are dependent on the current steering angle and are continuously adjusted to the steering wheel movements.

## Turning circle lines

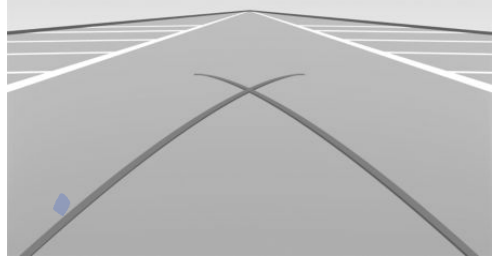

- ▷ Turning circle lines can only be superimposed on the rearview camera image together with pathway lines.
- ▷ They show the course of the smallest possible turning radius on a level road.
- ▷ Only one turning radius line is displayed after the steering wheel is turned past a certain angle.

021-8862088

FarmaSOS.com  
Obstacle marking

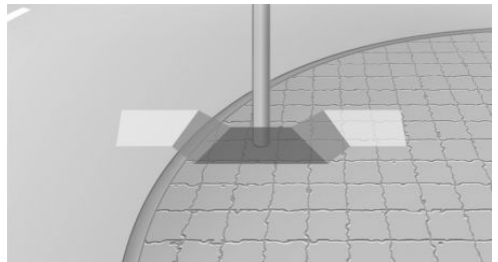

Obstacle markings can be faded into the image of the rearview camera.

Their colored margins match the markings of the PDC. This simplifies estimation of the distance to the object shown.

## Parking using pathway and turning radius lines

1. Position the vehicle so that the turning radius lines lead to within the limits of the parking space.

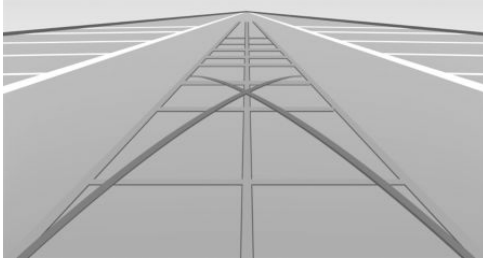

2. Turn the steering wheel to the point where the pathway line covers the corresponding turning radius line.

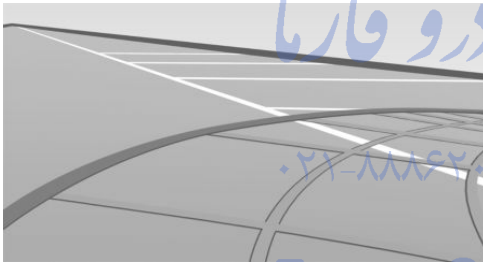

## Display settings

### Brightness

With the rearview camera switched on:

1. ☀ Select the symbol.
2. Turn the controller until the desired setting is reached, and press the controller.

### Contrast

With the rearview camera switched on:

1. ● Select the symbol.
2. Turn the controller until the desired setting is reached, and press the controller.

## System limits

### Detection of objects

Very low obstacles as well as high, protruding objects such as ledges may not be detected by the system.

Assistance functions also take into account data of the PDC.

Follow instructions in the PDC chapter, refer to page 132.

The objects displayed on the Control Display under certain circumstances are closer than they appear. Do not estimate the distance from the objects on the display.

## Side View

### The concept

Side View provides an early look at cross traffic at blind driveways and intersections. Road users concealed by obstacles to the left and right of the vehicle can only be detected relatively late from the driver's seat. To improve visibility, two cameras in the front of the vehicle record the traffic situation on each side.

### Hints

The images from both cameras are shown simultaneously on the Control Display.



Check the traffic situation as well

Check the traffic situation around the vehicle on blind driveways and intersections with your own eyes. Otherwise, an accident could result from road users or objects located outside the picture area of the Side View cameras. ◀

## At a glance

### Button in the vehicle



Side View

### Cameras

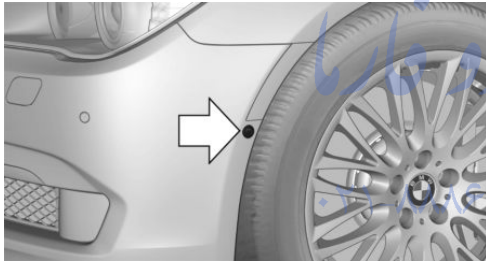

Two cameras integrated in the bumpers lidture the image.

The two camera lenses are located on the sides of the bumper.

The image quality may be impaired by dirt.

Clean the lens, refer to page [223](#).

### Switching on/off

#### Switching on/off manually



Press button.

#### Automatic deactivation during forward travel

The system switches off when a certain driving distance or speed is exceeded.

Switch the system back on if needed.

### Display

The traffic area to the left and right is displayed on the Control Display.

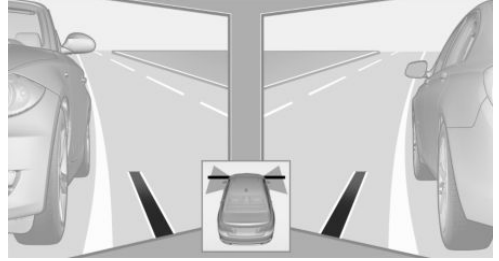

Guidelines at the bottom of the image show the position of the front of the vehicle.

### Brightness

With the Side View switched on:

1. ☀ "Brightness"
2. Turn the controller until the desired setting is reached, and press the controller.

### Contrast

With the Side View switched on:

1. ● "Contrast"
2. Turn the controller until the desired setting is reached, and press the controller.

### System limits

The cameras lidture a maximum range of 330 ft/100 m.

## Top View

### The concept

Top View provides assistance in parking and maneuvering. The area around the doors and the road area around the vehicle are shown on the Control Display for this purpose.

## General information

The image is captured by two cameras integrated in the exterior mirrors and by the rearview camera.

The range is at least 7 ft/2 m to the side and rear.

In this way, obstacles up to the height of the exterior mirrors are detected early.

## Hints

-  Check the traffic situation as well
- Check the traffic situation around the vehicle with your own eyes. Otherwise, an accident could result from road users or objects that are not captured by the camera. ◀

## At a glance

### Button in the vehicle



 Top View

## Cameras

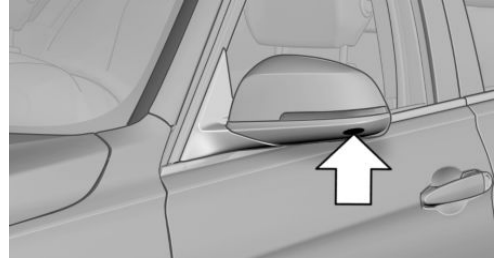

The lenses of the Top View camera are located at the bottom in the mirror housings. The image quality may be impaired by dirt.

Clean the lens, refer to page 223.

## Switching on/off

### Switching on automatically

With the engine running, engage lever in position P R.

The Top View and PDC images are displayed if the system is switched on via iDrive.

تلفن شبانه روزی: ۰۲۲-۱۸۸۶۲۰۸۵

### Automatic deactivation during forward travel

The system switches off when a certain driving distance or speed is exceeded.

Switch the system back on if needed.

### Switching on/off manually

 Press button.

- ▷ On: the LED lights up.
  - ▷ Off: the LED goes out.
- Top View is displayed.

## Display

### Visual warning

The approach of the vehicle to an object can be shown on the Control Display.

When the distance to an object is small, a red bar is shown in front of the vehicle, as it is in the PDC display.

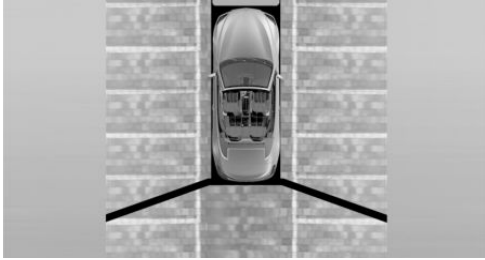

The display appears as soon as Top View is activated.

When the image of the rearview camera is displayed, it is possible to reel to top view:

 "Rear view camera"

### Brightness

With Top View switched on:

1.  Select the symbol.
2. Turn the controller until the desired setting is reached, and press the controller.

### Contrast

With Top View switched on:

1.  Select the symbol.
2. Turn the controller until the desired setting is reached, and press the controller.

### Displaying the turning radius and pathway lines

- ▷ The static, red turning radius line shows the space needed to the side of the vehicle when the steering wheel is turned all the way.
- ▷ The variable, green pathway line assists you in assessing the amount of space actually needed to the side of the vehicle. The lane line depends on the engaged gear and the current steering angle. The

track line is continuously adjusted for the steering wheel movement.

 "Parking aid lines"

Turning circle and pathway lines are displayed.

### System limits

Top View cannot be used in the following situations:

- ▷ With a door open.
- ▷ With the trunk lid open.
- ▷ With an exterior mirror folded in.
- ▷ In poor light.

A Check Control message is displayed in some of these situations.

## Parking assistant

### The concept

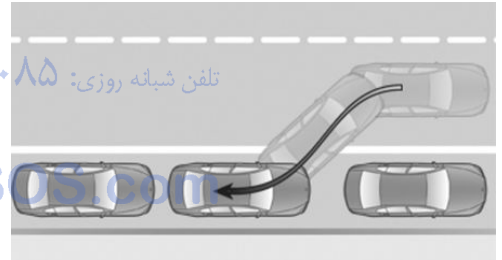

This system assists the driver in parking parallel to the road.

Ultrasound sensors measure parking spaces on both sides of the vehicle.

The parking assistant calculates the best possible parking line and takes control of steering during the parking procedure.

When parking, also take note of the visual and acoustic information and instructions issued by the PDC, the parking assistant and the rearview camera and react accordingly.

A component of the parking assistant is the PDC Park Distance Control, refer to page 132.



## Hints



### Personal responsibility

Even an active system does not relieve the driver from personal responsibility while driving.

Technically the system has its limits, it cannot independently react to all traffic situations.

Monitor your driving, be on the alert, observe the vehicle surroundings and other traffic and react when needed - risk of accident. ◀



### Changes to the parking space

Changes to the parking space after it was measured are not taken into account by the system.

Therefore, always be alert and ready to intervene; otherwise, there is the risk of an accident. ◀



### Transporting cargo

Cargo that extends beyond the perimeter of the vehicle is not taken into account by the system during the parking procedure.

Therefore, always be alert and ready to intervene; otherwise, there is the risk of an accident. ◀



### Curbs

The parking assistant may steer the vehicle over or onto curb if need be.

Therefore, always be alert and ready to intervene; otherwise, the wheels, tires, or the vehicle may become damaged. ◀

An engine that has been switched off by the Auto Start Stop function is restarted automatically when the parking assistant is activated.

## Requirements

### For measuring parking spaces

- ▷ Maximum speed while driving forward approx. 22 mph/35 km/h.

- ▷ Maximum distance to row of parked vehicles: 5 ft/1.5 m.

### Suitable parking space

- ▷ Gap between two objects with a minimum length of approx. 5 ft/1.5 m.
- ▷ Min. length of gap between two objects: your vehicle's length plus approx. 4 ft/1.2 m.
- ▷ Minimum depth: approx. 5 ft/1.5 m.

### Regarding the parking procedure

- ▷ Doors and trunk lid closed.
- ▷ Parking brake released.
- ▷ When parking in parking spaces on the driver's side, the corresponding turn signal must be set where applicable.

### At a glance

### Button in the vehicle



Parking assistant

## Ultrasound sensors

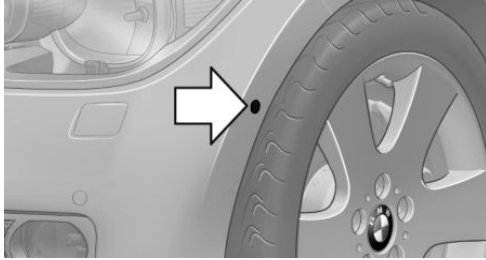

The ultrasound sensors for measuring parking spaces are located on the side of the vehicle.

To ensure full functionality:

- ▷ Keep the sensors clean and free of ice.
- ▷ When using high-pressure washers, do not spray the sensors for long periods and maintain a distance of at least 12 in/30 cm.
- ▷ Do not put stickers over sensors.

## Switching on/off

### Switching on with the button



Press button.

The LED lights up.

The current status of the parking space search is indicated on the Control Display.

 Parking assistant is activated automatically.

### Switching on with the reverse gear

Shift into reverse.

The current status of the parking space search is indicated on the Control Display.

To activate:  "Parking Assistant"



### Switch off

The system can be deactivated as follows:

- ▷  Press button.
- ▷ Switch off the ignition.

## Display on the Control Display

### System activated/deactivated

| Symbol  | Meaning   |
|---|---|
|  | Gray: the system is not available.<br>White: the system is available but not activated. |
|  | The system is activated.  |

### System status

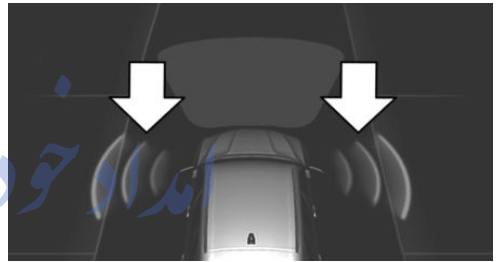

- ▷ Colored symbols, see arrows, on the side of the vehicle illustrated. Parking assistant is activated and search for parking space active.
- ▷ Control Display shows suitable parking spaces at the edge of the road next to the vehicle symbol. When the parking assistant is active, suitable parking spaces are highlighted.
- ▷  The parking procedure is active. Steering control has been taken over by system.
- ▷ Parking space search is always active whenever the vehicle is moving forward slow and straight, even if the system is deactivated. When the system is deactivated, the displays on the Control Display are shown in gray.

## Parking using the parking assistant



Check the traffic situation as well



Loud noises outside and inside the vehicle can drown out the parking assistant's and PDC's signals.

Check the traffic situation around the vehicle with your own eyes; otherwise, there is a danger of an accident. ◀

1. Switch on the parking assistant and activate it if needed.  
The status of the parking space search is indicated on the Control Display.
2. Follow the instructions on the Control Display.  
The best possible parking position will come after gear change on the stationary vehicle - wait for the automatic steering wheel move.  
The end of the parking procedure is indicated on the Control Display.
3. Adjust the parking position yourself if needed.

## Interrupting manually

The parking assistant can be interrupted at any time:

- ▷  "Parking Assistant" Select the symbol on the Control Display.
- ▷  Press button.

## Interrupting automatically

The system is interrupted automatically in the following situations:

- ▷ If the driver grasps the steering wheel or if he takes over steering.
- ▷ If a gear is selected that does not match the instruction on the Control Display.
- ▷ If the vehicle speed exceeds approx. 6 mph/10 km/h.

- ▷ Possible on snow-covered or slippery road surfaces.
- ▷ When there are obstacles that are hard to overcome, such as curbs.
- ▷ When there are obstacles that suddenly arise.
- ▷ If the Park Distance Control PDC displays clearances that are too small.
- ▷ If a maximum number of parking attempts or the time taken for parking is exceeded.
- ▷ If a turn signal has been actuated contrary to the desired side for parking.
- ▷ When switching to another function on the Control Display.

A Check Control message is displayed.

## Resume

An interrupted parking procedure can be continued if needed.

Follow the instructions on the Control Display to do this.

## System limits

### No parking assistance

The parking assistant does not offer assistance in the following situations:

- ▷ In tight curves.

### Functional limitations

The system may not be fully functional in the following situations:

- ▷ On bumpy road surfaces such as gravel roads.
- ▷ On slippery ground.
- ▷ On steep uphill or downhill grades.
- ▷ With accumulations of leaves/snow in the parking space.

### Limits of ultrasonic measurement

Ultrasonic measuring might not function under the following circumstances:

- ▷ For small children and animals.
- ▷ For persons with certain clothing, e.g. coats.
- ▷ With external interference of the ultrasound, e.g. from passing vehicles or loud machines.
- ▷ When sensors are dirty, iced over, damaged or out of position.
- ▷ Under certain weather conditions such as high relative humidity, rain, snowfall, extreme heat or strong wind.
- ▷ With tow bars and trailer couplings of other vehicles.
- ▷ With thin or wedge-shaped objects.
- ▷ With moving objects.
- ▷ With elevated, protruding objects such as ledges or cargo.
- ▷ With objects with corners and sharp edges.
- ▷ With objects with a fine surface structure such as fences.
- ▷ For objects with porous surfaces.

Low objects already displayed, e.g., curbs, can move into the blind area of the sensors before or after a continuous tone sounds.

The parking assistant may identify parking spaces that are not suitable for parking.

### Malfunction

A Check Control message is displayed.

The parking assistant failed. Have the system checked.

# Climate control

## Vehicle features and options

This chapter describes all standard, country-specific and optional features offered with the series. It also describes features that are not

necessarily available in your car, e. g., due to the selected options or country versions. This also applies to safety-related functions and systems.

## Automatic climate control

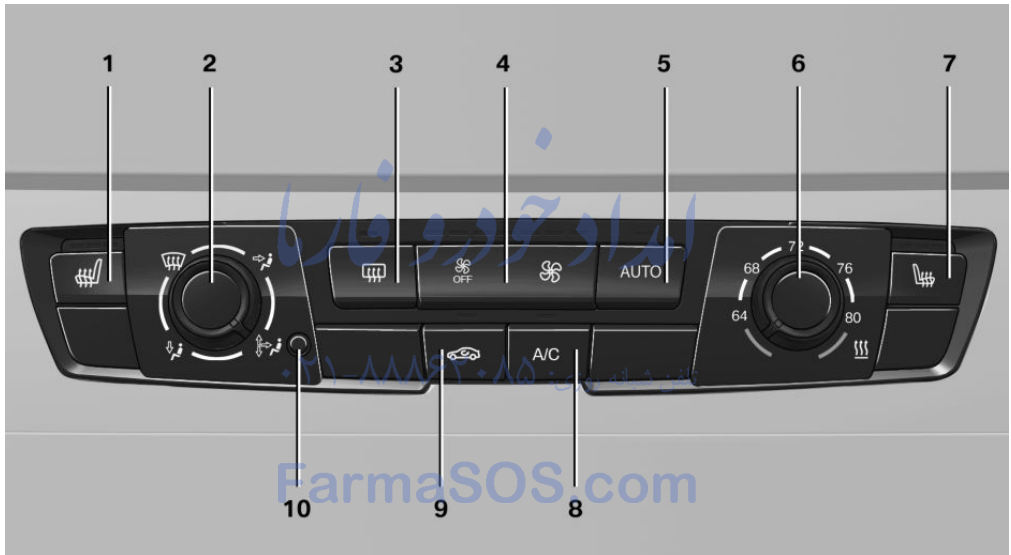

- |   |                       |    |    |                             |
|---|-----------------------|----|----|-----------------------------|
| 1 | Seat heating, left    | 54 | 6  | Temperature                 |
| 2 | Vent settings         |    | 7  | Seat heating, right         |
| 3 | Rear window defroster |    | 8  | Cooling function            |
| 4 | Air flow              |    | 9  | Recirculated-air mode       |
| 5 | AUTO program          |    | 10 | Interior temperature sensor |

### Hints



Sufficient ventilation

When remaining in the vehicle for an extended period of time, ensure sufficient external ventilation. Do not continuously use recir-

culated-air mode; otherwise the air quality in the interior continuously worsens. ◀

## Climate control functions in detail

### Manual air distribution



Turn the wheel to select the desired program or the desired intermediate setting.

- ▷ Windows.
- ▷ Upper body region.
- ▷ Windows, upper body region, and footwell.
- ▷ Footwell.

### Defrosts windows and removes condensation

Direct the air distribution toward windows, increase the air flow and temperature, and, if needed, use the cooling function.

### Rear window defroster



Press button.

The rear window defroster switches off automatically after a certain period of time.

### Air flow, manual



Press the left or right side of the button: decrease or increase air flow.

The air flow from the air conditioner may be reduced automatically to save battery power.

### AUTO program



Press button.

Air flow, air distribution and temperature are controlled automatically.

Depending on the selected temperature and outside influences, the air is directed to the windshield, side windows, upper body, and into the footwell.

The cooling function, refer to page 146, is switched on automatically with the AUTO program.

### Convertible program

When the hardtop is open, the convertible program is activated as well. In the convertible program, the automatic climate control is optimized for driving with the hardtop open. In addition, the air flow is increased as the vehicle speed increases.

The efficiency of the convertible program can be greatly enhanced by installing the wind deflector.

### Temperature



Turn the ring to set the desired temperature.

The automatic climate control reaches this temperature as quickly as possible, if needed by increasing the cooling or heating output, and then keeps it constant.

Do not rapidly switch between different temperature settings. Otherwise, the automatic climate control will not have sufficient time to adjust the set temperature.

### Cooling function

The car's interior can only be cooled with the engine running.



Press button.

The air will be cooled and dehumidified and, depending on the temperature setting, warmed again.

Depending on the weather, the windshield and side windows may fog up briefly when the engine is started.

The cooling function is switched on automatically with the AUTO program.

When using the automatic climate control, condensation water, refer to page 170, develops that exits underneath the vehicle.

### Recirculated-air mode

You may respond to unpleasant odors or pollutants in the immediate environment by temporarily suspending the supply of outside air. The system then recirculates the air currently within the vehicle.



Press button repeatedly to select an operating mode:

- ▷ LED off: outside air flows in continuously.
- ▷ LED on, recirculated-air mode: the supply of outside air into the vehicle is permanently blocked.

Recirculated air mode switches off automatically at low external temperatures after a certain amount of time in order to avoid window fogging.

If the windows fog over, reel off recirculated-air mode and increase the air flow, if needed.



#### Sufficient ventilation

When remaining in the vehicle for an extended period of time, ensure sufficient external ventilation. Do not continuously use recir-

culated-air mode; otherwise the air quality in the interior continuously worsens. ◀

### Switching the system on/off

#### Switch off



Press the left button for the minimum speed.

#### Switching on

Press any button except

- ▷ Rear window defroster.
- ▷ Seat heating.

#### Microfilter

In external and recirculated air mode the microfilter filters dust and pollen from the air.

This filter should be replaced during scheduled maintenance, refer to page 204, of your vehicle.

تلفن شبانه روزی: ۰۲۱-۸۸۶۲۰۸۵

FarmaSOS.com

## Automatic climate control with enhanced features

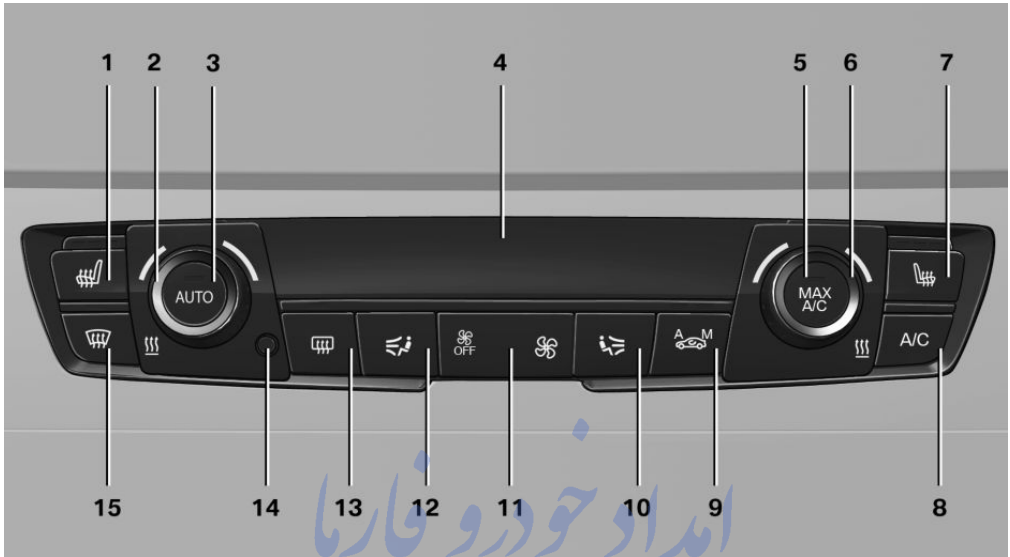

- |   |  |    |    |   |
|---|--|----|----|---|
| 1 | Seat heating, left                                       | 54 | 10 | Air distribution, right                         |
| 2 | Temperature, left  |    | 11 | Air flow, AUTO intensity                        |
| 3 | AUTO program   |    | 12 | Air distribution, left                          |
| 4 | Display  |    | 13 | Rear window defroster                           |
| 5 | Maximum cooling  |    | 14 | Interior temperature sensor — always keep clear |
| 6 | Temperature, right                                       |    | 15 | Defrosts windows and removes condensation       |
| 7 | Seat heating, right                                      | 54 |    |   |
| 8 | Cooling function   |    |    |   |
| 9 | Automatic recirculated-air control/recirculated-air mode |    |    |   |

### Hints

-  Sufficient ventilation

When remaining in the vehicle for an extended period of time, ensure sufficient external ventilation. Do not continuously use recirculated-air mode; otherwise the air quality in the interior continuously worsens. ◀

### Climate control functions in detail

#### Temperature



Turn the ring to set the desired temperature.

The automatic climate control reaches this temperature as quickly as possible, if needed



by increasing the cooling or heating output, and then keeps it constant.

Do not rapidly switch between different temperature settings. Otherwise, the automatic climate control will not have sufficient time to adjust the set temperature.

## AUTO program

 Press button.

Air flow, air distribution and temperature are controlled automatically.

Depending on the selected temperature, AUTO intensity program and outside influences, the air is directed to the windshield, side windows, upper body, and into the footwell.

The cooling function, refer to page 149, is switched on automatically with the AUTO program.

At the same time, a condensation sensor controls the program so as to prevent window condensation as much as possible.

## Intensity of the AUTO program

With the AUTO program activated, the automatic intensity control can be changed.

 Press the left or right side of the button: decrease or increase the intensity.

The selected intensity is shown on the display of the automatic climate control.

## Convertible program

When the hardtop is open, the convertible program is activated as well. In the convertible program, the automatic climate control is optimized for driving with the hardtop open. In addition, the air flow is increased as the vehicle speed increases.

The efficiency of the convertible program can be greatly enhanced by installing the wind deflector.

## Maximum cooling

 Press button.

The system is set to the lowest temperature, optimum air flow and air circulation mode.

Air flows out of the vents to the upper body region. The vents need to be open for this.

The function is available above an external temperature of approx. 32 °F/0 °C and with the engine running.

Adjust air flow with the program active.

## Cooling function

The car's interior can only be cooled with the engine running.

 Press button.

The air will be cooled and dehumidified and, depending on the temperature setting, warmed again.

Depending on the weather, the windshield and side windows may fog up briefly when the engine is started.

The cooling function is switched on automatically with the AUTO program.

When using the automatic climate control, condensation water, refer to page 170, develops that exits underneath the vehicle.

## Automatic recirculated-air control/ recirculated-air mode

You may respond to unpleasant odors or pollutants in the immediate environment by temporarily suspending the supply of outside air. The system then recirculates the air currently within the vehicle.

 Press button repeatedly to select an operating mode:

- ▷ LEDs off: outside air flows in continuously.

- ▷ Left LED on, automatic recirculated-air control: a sensor detects pollutants in the outside air and shuts off automatically.
- ▷ Right LED on, recirculated-air mode: the supply of outside air into the vehicle is permanently blocked.

Recirculated air mode switches off automatically at low external temperatures after a certain amount of time in order to avoid window fogging.

If the windows are fogged over, reel off the recirculated-air mode and press the AUTO button to utilize the condensation sensor. Make sure that air can flow to the windshield.

### Sufficient ventilation

When remaining in the vehicle for an extended period of time, ensure sufficient external ventilation. Do not continuously use recirculated-air mode; otherwise the air quality in the interior continuously worsens. ◀

## Manual air distribution



Press button repeatedly to select a program:

- ▷ Upper body region.
- ▷ Upper body region and footwell.
- ▷ Footwell.
- ▷ Windows and footwell: driver's side only.
- ▷ Windows, upper body region and footwell: driver's side only.

If the windows are fogged over, press the AUTO button to utilize the condensation sensor.

## Air flow, manual

To manually adjust air flow turn off AUTO program first.



Press the left or right side of the button: decrease or increase air flow.

The selected air flow is shown on the display of the automatic climate control.

The air flow of the automatic climate control may be reduced automatically to save battery power.

## Rear window defroster



Press button.

The rear window defroster switches off automatically after a certain period of time.

## Defrosts windows and removes condensation



Press button.

Ice and condensation are quickly removed from the windshield and the front side windows.

For this purpose, point the side vents onto the side windows as needed.

Adjust air flow with the program active.

If the windows are fogged over, you can also reel on the cooling function or press the AUTO button to utilize the condensation sensor.

## Switching the system on/off

### Switch off



Press the left button for the minimum speed.

### Switching on

Press any button except

- ▷ Rear window defroster.
- ▷ Seat heating.

## Microfilter/activated-charcoal filter

In external and recirculated air mode the microfilter/activated charcoal filter filters dust, pollen, and gaseous pollutants out of the air.

This filter should be replaced during scheduled maintenance, refer to page 204, of your vehicle.

## Ventilation

### Front ventilation

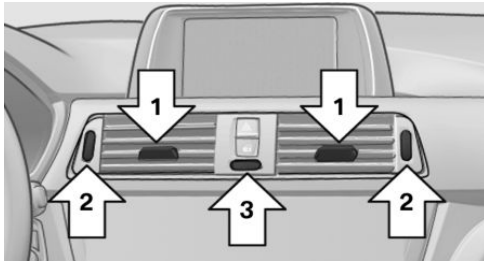

- ▶ Lever for changing the air flow direction, arrow 1.
- ▶ Thumbwheels for opening and closing the vents continuously, arrows 2.
- ▶ Thumbwheel to vary the temperature in the upper body region, arrow 3.  
Toward blue: colder.  
Toward red: warmer.

The set interior temperature for the driver and passenger are not changed.

### Adjusting the ventilation

- ▶ Ventilation for cooling:  
Direct vent in your direction when vehicle's interior is too hot.
- ▶ Draft-free ventilation:  
Adjust the vent to let the air flow past you.

### Ventilation in the rear

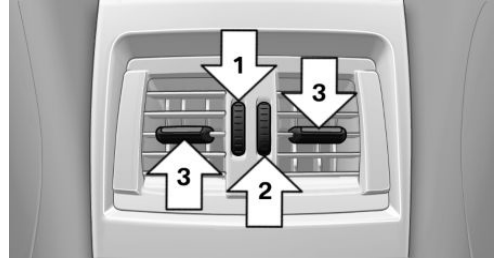

- ▶ Thumbwheel for continuous opening and closing of the vents, arrow 1.
- ▶ Thumbwheel to vary the temperature, arrow 2.  
Toward blue: colder.  
Toward red: warmer.
- ▶ Lever for changing the air flow direction, arrow 3.

## Parked-car ventilation

### The concept

The parked-car ventilation ventilates the vehicle interior and lowers its temperature, if needed.

The system can be switched on and off at any external temperature, either directly or by using two preset reel-on times. It remains switched on for 30 minutes.

Open the vents to allow air to flow out.

### Switching on/off directly

On the Control Display:

1. "Settings"
2. "Climate"
3. "Activate comf. ventilation"

☞ The symbol on the automatic climate control flashes if the system is switched on.

### Preselecting the reel-on time

On the Control Display:

1. "Settings"
2. "Climate"
3. "Timer 1:" or "Timer 2:"
4. Set the desired time.

### Activating the reel-on time

On the Control Display:

1. "Settings"
2. "Climate"
3. "Activate timer 1" or "Activate timer 2"

☞ The symbol on the automatic climate control lights up when the reel-on time is activated.

☞ The symbol on the automatic climate control flashes when the system has been switched on.

The system will only be switched on within the next 24 hours. After that, it needs to be reactivated.

تلفن شبانه روزی: ۰۲۱-۸۸۸۶۲۰۸۵

FarmaSOS.com

# Interior equipment

## Vehicle features and options

This chapter describes all standard, country-specific and optional features offered with the series. It also describes features that are not necessarily available in your car, e. g., due to the selected options or country versions. This also applies to safety-related functions and systems.

## Universal Integrated Remote Control

### The concept

The universal garage door opener can operate up to 3 functions of remote-controlled systems such as garage door drives or lighting systems. The universal garage door opener replaces up to 3 different hand-held transmitters. To operate the remote control, the buttons on the interior rearview mirror must be programmed with the desired functions. The hand-held transmitter for the particular system is required in order to program the remote control.

 During programming

During programming and before activating a device using the universal garage door opener, ensure that there are no people, animals or objects in the area of the remote-controlled device; otherwise, there is a risk of injury or damage.

Also follow the safety instructions of the hand-held transmitter. ◀

Before selling the vehicle, delete the stored functions for the sake of security.

### Compatibility



If this symbol is printed on the packaging or in the instructions of the system to be controlled, the system is gener-

ally compatible with the universal garage door opener.

If you have any questions, please contact:

- ▷ Your service center.
- ▷ [www.homelink.com](http://www.homelink.com) on the Internet.

HomeLink is a registered trademark of Gentex Corporation.

### Control elements on the interior rearview mirror

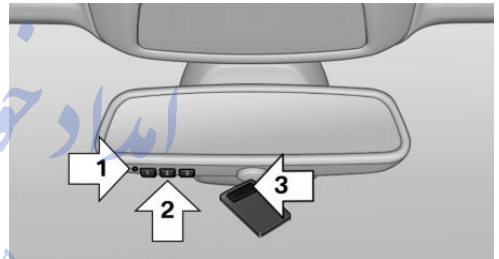

- ▷ LED, arrow 1.
- ▷ Buttons, arrow 2.
- ▷ The hand-held transmitter, arrow 3, is required for programming.

### Programming

#### General information

1. Switch on the ignition.
2. Initial setup:
 

Press and hold the left and right button on the interior rearview mirror simultaneously for approximately 20 seconds until the LED on the interior rearview mirror flashes. This erases all programming of the buttons on the interior rearview mirror.
3. Hold the hand-held transmitter for the system to be controlled approx. 1 to 3 in/2.5 to 8 cm away from the buttons of the interior

rearview mirror. The required distance depends on the manual transmitter.

4. Simultaneously press and hold the button of the desired function on the hand-held transmitter and the button to be programmed on the interior rearview mirror. The LED on the interior rearview mirror will begin flashing slowly.
5. Release both buttons as soon as the LED flashes more rapidly. The LED flashing faster indicates that the button on the interior rearview mirror has been programmed. If the LED does not flash faster after at least 60 seconds, change the distance between the interior rearview mirror and the hand-held transmitter and repeat the step. Several more attempts at different distances may be necessary. Wait at least 15 seconds between attempts.  
Canada: if programming with the hand-held transmitter was interrupted, hold down the interior rearview mirror button and repeatedly press and release the hand-held transmitter button for 2 seconds.
6. To program other functions on other buttons, repeat steps 3 to 5.

The systems can be controlled using the interior rearview mirror buttons.

### Special feature of the alternating-code wireless system

If you are unable to operate the system after repeated programming, please check if the system to be controlled features an alternating-code system.

Read the system's operating manual, or press the programmed button on the interior rearview mirror longer. If the LED on the interior rearview mirror starts flashing rapidly and then stays lit constantly for 2 seconds, the system features an alternating-code system. Flashing and continuous illumination of the LED will repeat for approximately 20 seconds.

For systems with an alternating-code system, the universal garage door opener and the system also have to be synchronized.

Please read the operating manual to find out how to synchronize the system.

Synchronizing is easier with the aid of a second person.

To synchronize:

1. Park the vehicle within range of the remote-controlled system.
2. Program the relevant button on the interior rearview mirror as described.
3. Locate and press the synchronizing button on the system being programmed. You have approx. 30 seconds for the next step.
4. Hold down the programmed button on the interior rearview mirror for approximately 3 seconds and then release it. If necessary, repeat this step up to three times in order to finish synchronization. Once synchronization is complete, the programmed function will be carried out.

### Reprogramming individual buttons

1. Switch on the ignition.
2. Press and hold the interior rearview mirror button to be programmed.
3. As soon as the interior rearview mirror LED starts flashing slowly, hold the hand-held transmitter for the system to be controlled approx. 1 to 3 in/2.5 to 8 cm away from the buttons of the interior rearview mirror. The required distance depends on the manual transmitter.
4. Likewise, press and hold the button of the desired function on the hand-held transmitter.
5. Release both buttons as soon as the interior rearview mirror LED flashes more rapidly. The LED flashing faster indicates that the button on the interior rearview mirror has been programmed. The system can

then be controlled by the button on the interior rearview mirror.

If the LED does not flash faster after at least 60 seconds, change the distance and repeat the step. Several more attempts at different distances may be necessary. Wait at least 15 seconds between attempts.

Canada: if programming with the hand-held transmitter was interrupted, hold down the interior rearview mirror button and repeatedly press and release the hand-held transmitter button for 2 seconds.

## Controls

### Before operation

Before operating a system using the universal garage door opener, ensure that there are no people, animals, or objects within the range of movement of the remote-controlled system; otherwise, there is a risk of injury or damage.

Also follow the safety instructions of the hand-held transmitter. ◀

The system, such as the garage door, can be operated using the button on the interior rearview mirror while the engine is running or when the ignition is started. To do this, hold down the button within receiving range of the system until the function is activated. The interior rearview mirror LED stays lit while the wireless signal is being transmitted.

## Deleting stored functions

Press and hold the left and right button on the interior rearview mirror simultaneously for approximately 20 seconds until the LED flashes rapidly. All stored functions are deleted. The functions cannot be deleted individually.

## Digital compass

### At a glance

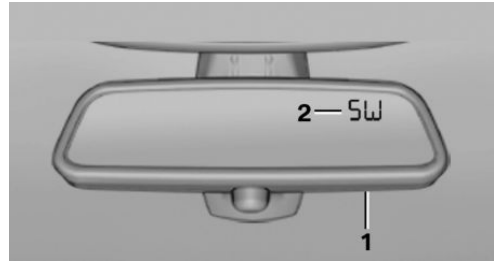

- 1 Control button
- 2 Mirror display

### Mirror display

The point of the compass is displayed in the mirror when driving straight.

### Operating concept

Various functions can be called up by pressing the control button with a pointed object, such as the tip of a ballpoint pen or similar object.

The following setting options are displayed in succession, depending on how long the control button is pressed:

- ▷ Pressed briefly: turns display on/off.
- ▷ 3 to 6 seconds: compass zone setting.
- ▷ 6 to 9 seconds: compass calibration.
- ▷ 9 to 12 seconds: left/right-hand steering setting.
- ▷ 12 to 15 seconds: language setting.

### Setting the compass zones

Sets the particular compass zones on the vehicle so that the compass operates correctly; refer to World map with compass zones.

## World map with magnetic zones

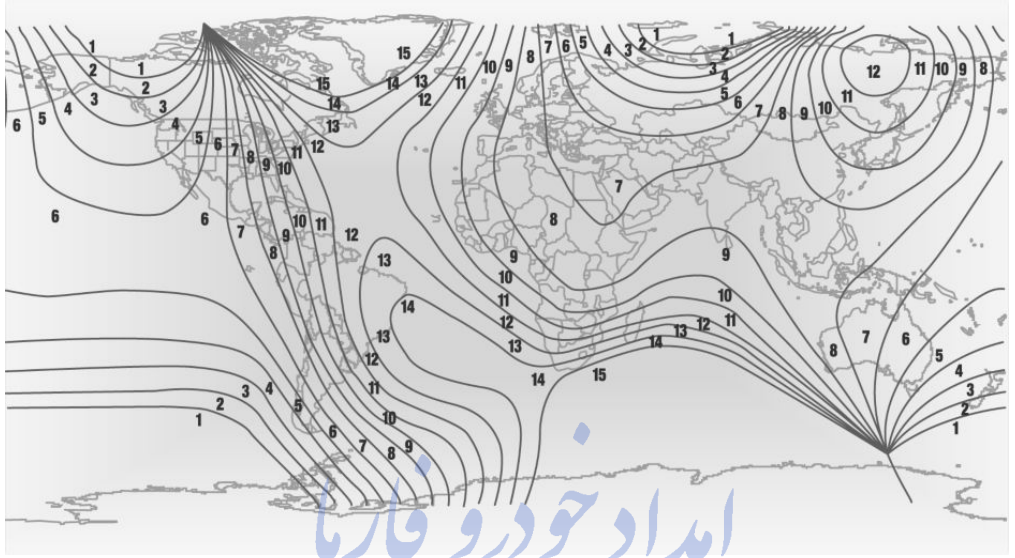

### Procedure

1. Press and hold the control button for approx. 3 to 4 seconds. The number of the set compass zone appears in the mirror.
2. To change the zone setting, press the control button quickly and repeatedly until the number of the compass zone that corresponds with your location appears in the mirror.

The set zone is stored automatically. The compass is ready for use again after approximately 10 seconds.

### Calibrating the digital compass

The digital compass must be calibrated in the event of the following:

- ▷ The wrong compass point is displayed.
- ▷ The point of the compass displayed does not change despite changing the direction of travel.
- ▷ Not all points of the compass are displayed.

### Procedure

1. Make sure that there are no large metallic objects or overhead power lines near the vehicle and that there is sufficient room to drive around in a circle.
2. Set the currently applicable compass zone.
3. Press and hold the control button for approx. 6 to 7 seconds so that "C" appears on the display. Next, drive in a complete circle at least once at a speed of no more than 4 mph/7 km/h. If calibration is successful, the "C" is replaced by the points of the compass.

### Left/right-hand steering

The digital compass is already set for right or left-hand steering at the factory.

### Setting the language

Press and hold the control button for approx. 12 to 13 seconds. Briefly press the control button again to reel between English "E" and German "O".



Settings are stored automatically after approximately 10 seconds.

## Sun visor

### Glare shield

Fold the sun visor down or up.

### Vanity mirror

A vanity mirror is located in the sun visor behind a cover. When the cover is opened, the mirror lighting switches on.

## Ashtray/cigarette lighter

### Ashtray

#### Opening

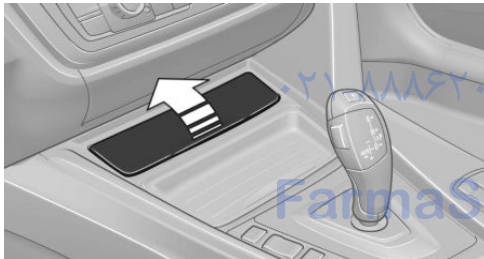

Raise cover.

#### Emptying

Take out the insert.

#### Lighter

 Danger of burns

Only hold the hot lighter by its knob; otherwise, there is a danger of getting burned.

Switch off the ignition and take the remote control with you when leaving the vehicle so that children cannot use the lighter and burn themselves. ◀



Replace the cover after use

Reinsert the lighter or socket cover after use, otherwise objects may get into the lighter socket or fixture and cause a short circuit. ◀

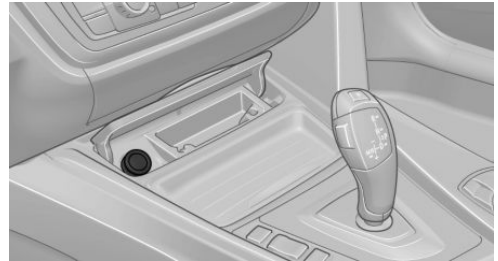

The lighter is located next to the ashtray.



Push in the lighter.

The lighter can be removed as soon as it pops back out.

## Connecting electrical devices

### Hints



Do not connect charging devices to the 12 volt socket in the vehicle

Do not connect battery chargers to the factory-installed 12 volt sockets in the vehicle as this may damage the vehicle battery due to an increased power consumption. ◀



Replace the cover after use

Reinsert the lighter or socket cover after use, otherwise objects may get into the lighter socket or fixture and cause a short circuit. ◀

### Sockets

#### General information

The lighter socket can be used as a socket for electrical equipment while the engine is running or when the ignition is switched on.

## Note

The total load of all sockets must not exceed 140 watts at 12 volts.

Do not damage the socket by using unsuitable connectors.

## Front center console



Raise the lid and remove the cover or cigarette lighter.

## In the front passenger footwell



The socket is located below the glove compartment.

## Rear center console



Remove the cover.

## In the cargo area

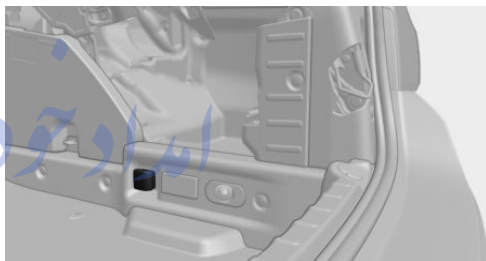

The socket is located on the right side in the cargo area.

## USB interface for data transfer

### The concept

Connection for importing and exporting data on USB devices, e.g.:

- ▷ Personal Profile settings, refer to page 35.
- ▷ Music collection.
- ▷ Importing Trips.

### Hints

Observe the following when connecting:

- ▷ Do not use force when plugging the connector into the USB interface.

- Do not connect devices such as fans or lights to the USB interface.
- Do not connect USB hard drives.
- Do not use the USB interface for recharging external devices.

### Without telephone: overview

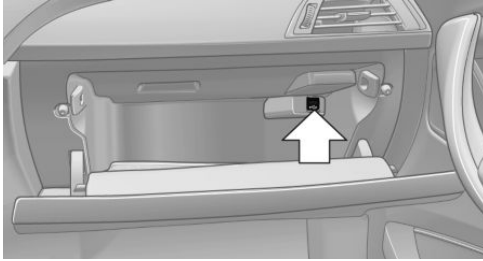

The USB interface is located in the glove compartment.

### With telephone: overview

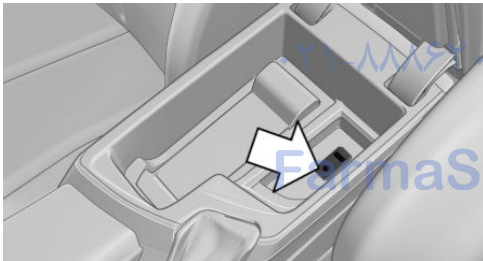

The USB interface is located in the center armrest.

## Loading

### The concept

For easier loading, the vehicle is equipped with a cargo area partition and a Loading aid, refer to page 160. With the loading aid, the folded hardtop can be raised out of the cargo area.

### Hints



Do not deposit any objects on the cargo area partition

Before opening the hardtop or lowering the loading aid, make sure that there are no objects on or next to the cargo area partition. Otherwise, hardtop or loading aid can be damaged. ◀

### Opening hardtop or lowering loading aid

Before opening the hardtop or lowering the loading aid, push the cargo area partition down until it latches on both sides. Otherwise, the hardtop cannot be opened or the loading aid cannot be lowered.



When the hardtop is open, objects can be placed below the cargo area partition. Do not use the areas marked X in the illustration as storage areas.

### Closing the hardtop

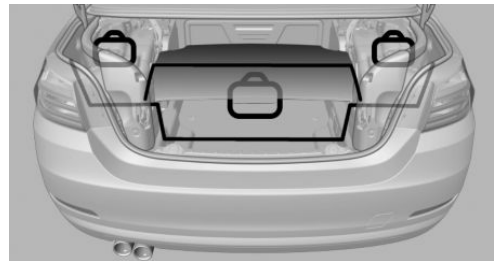

When the hardtop is closed, objects can be placed in the area below and next to the cargo area partition.

## Expanding cargo area volume

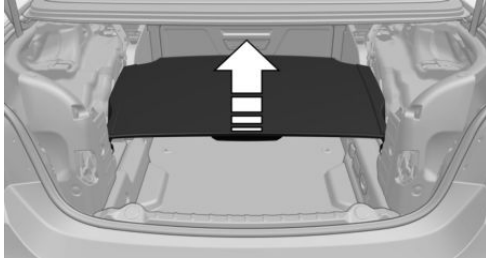

With the hardtop closed, the cargo area volume can be expanded. To do this, push the cargo area partition upward.

## Loading aid

### Hints

**!** Operation of the loading aid  
Before operating the loading aid, make sure that the movement area of the loading aid is clear. During the lowering or raising of the loading aid, do not reach into the mechanism. Keep persons away from the area of movement of the loading aid. Otherwise, damages or personal injuries may result. ◀

**!** Raised loading aid  
Do not drive with the loading aid raised. Before driving off, make sure that the loading aid is completely lowered and the trunk lid is closed. Otherwise, damage may result. ◀

### Functional requirements

- ▷ Vehicle at a standstill.
- ▷ Vehicle is on a level surface.
- ▷ Hardtop fully open.
- ▷ Trunk lid fully open.
- ▷ Cargo area partition latched in the lower position.
- ▷ External temperature not below +14 °F/-10 °C.

## Controls

Open trunk lid all the way.



Press left button: loading aid is raised.

Press right button: loading aid is lowered.

The movement is executed at different speeds depending on the external temperature.

The movement stops with the release of the button.

LED in button:

- ▷ Lights up continuously: loading aid in the respective limit position.
- ▷ Flashes fast: loading aid not in the respective end position.
- ▷ Flashes slowly: functional requirements not met.

A Check Control message is displayed.

After switching off the ignition, the raised loading aid can be lowered within approx. 10 minutes. After that, the ignition must be switched on for lowering.

Use the loading aid only for loading and unloading the cargo area.

Always move the loading aid into the limit positions.

Do not park the vehicle with the loading aid raised.

The trunk lid can only be closed when the loading aid is fully lowered.

## Through-loading system

### The concept

The cargo area can be enlarged by folding down the rear seat backrest or removing the middle section.

### Hints

#### Danger of jamming

Before folding down the rear seat backrests, ensure that the area of movement of the backrests is clear. Ensure that no one is located in or reaches into the area of movement of the rear seat backrests. Otherwise, injury or damage may result. ◀

#### Ensuring the stability of the child seat

When installing child restraint systems, make sure that the child seat is securely fastened to the backrest of the seat. Angle and headrest of the backrest might need to be adjusted or possibly be removed. Make sure that all backrests are securely locked. Otherwise the stability of the child seat can be affected, and there is an increased risk of injury because of unexpected movement of the rear seat backrest. ◀

### Opening

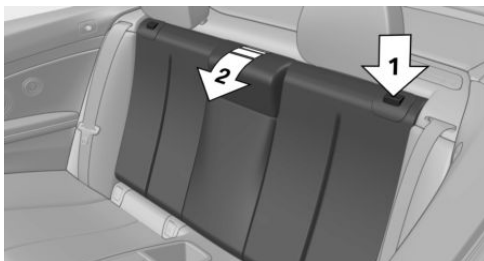

Unlock the rear seat backrest, arrow 1, and fold forward, arrow 2.

### Closing

Return the rear seat backrest to the upright seating position and engage it.



Ensure that the lock is securely engaged

Make sure that the lock engages properly when folding back, otherwise transported cargo could enter the car's interior during braking or evasive maneuvers and endanger the vehicle's occupants. ◀

To secure cargo, refer to page 172, with nets or draw straps, the cargo area is fitted with lashing eyes.

### Middle section

#### Removing

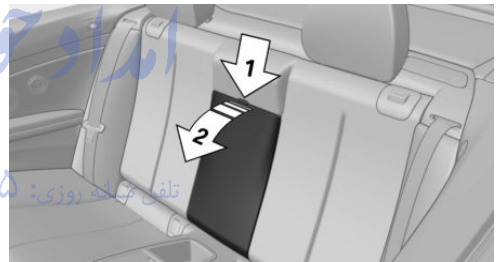

Push down the tab, arrow 1, and remove the center section, arrow 2.

### Anti-theft protection

#### The concept

The anti-theft protection prevents access to the cargo area from the interior.

## Opening

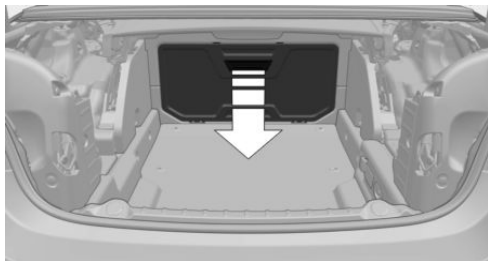

Pull on the handle and fold open the anti-theft protection.

## Closing

Fold open the anti-theft protection until it engages.

امداد خودرو فارما

تلفن شبانه روزی: ۰۲۱-۸۸۸۶۲۰۸۵

FarmaSOS.com

# Storage compartments

## Vehicle features and options

This chapter describes all standard, country-specific and optional features offered with the series. It also describes features that are not necessarily available in your car, e. g., due to the selected options or country versions. This also applies to safety-related functions and systems.

## Hints



No loose objects in the car's interior

Do not stow any objects in the car's interior without securing them; otherwise, they may present a danger to occupants e.g., during braking and evasive maneuvers. ◀



Do not place anti-slip mats on the dashboard

Do not place anti-slip mats on the dashboard. The mat materials could damage the dashboard. ◀

## Storage compartments

The following storage compartments are available in the vehicle interior:

- ▶ Glove compartment on the front passenger side, refer to page 163.
- ▶ Glove compartment on the driver's side, refer to page 164.
- ▶ Without Smoker's package: Front storage compartment, in front of the cupholders, refer to page 164.
- ▶ Storage compartment in the front center armrest, refer to page 164.
- ▶ Compartments in the doors, refer to page 164.
- ▶ Nets on the backrests of the front seats.

- ▶ Storage compartment in the rear center console, refer to page 165.
- ▶ Storage compartment between the rear seats, refer to page 165.

## Glove compartment

### Front passenger side

#### Note



Close the glove compartment again immediately

Close the glove compartment immediately after use while driving; otherwise, injury may occur during accidents. ◀

#### Opening



Pull the handle.

The light in the glove compartment switches on.

#### Closing

Fold cover closed.

#### Locking

The glove compartment can be locked with an integrated key to separately secure the trunk lid, refer to page 40, e.g.

This prevents access to the glove compartment and to the cargo area.

After the glove compartment is locked, the remote control can be handed over, such as at a hotel, without the integrated key.

## Driver's side

### Note

 Close the glove compartment again immediately

Close the glove compartment immediately after use while driving; otherwise, injury may occur during accidents. ◀

### Opening



Pull the handle.

### Closing

Fold cover closed.

## Front storage compartment

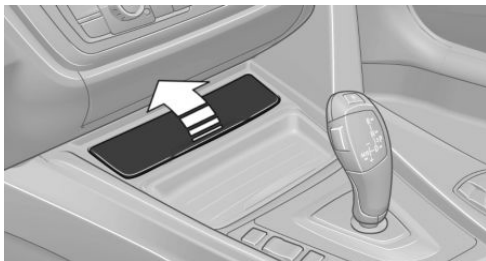

Raise the lid to open it.

## Compartments in the doors

 Do not stow any breakable objects

Do not store any breakable objects, e. g. glass bottles, in the compartments, or there is an increased risk of injury in the event of an accident. ◀

## Center armrest

### Front

A storage compartment is located in the center armrest between the front seats.

The central locking system locks the center armrest.

### Opening



Fold the center armrest up.

### Repositioning

Center armrest can be pushed forwards or backwards. It engages in the end positions.

### Connection for an external audio device



An external audio device, e.g., an MP3 player, can be connected via the AUX-IN port or the USB audio interface in the center armrest.



## Storage compartment in the rear

A storage compartment is located in the center armrest.

## Storage compartment between the rear seats

There is a storage compartment between the rear seats.

## Cupholders

### Hints

 Shatter-proof containers and no hot drinks

Use light and shatter-proof containers and do not transport hot drinks. Otherwise, there is the increased danger of injury in an accident. ◀

 Unsuitable containers  
Do not forcefully push unsuitable containers into the cupholders. This may result in damage. ◀

### Front



### Rear

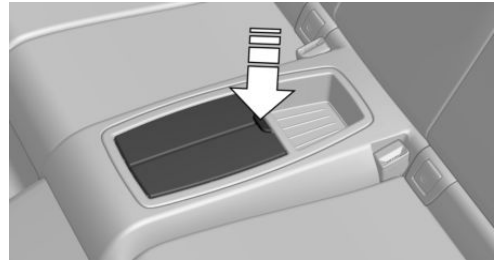

To open: press the button.

To close: push both covers back in, one after the other.

## Storage compartments in the cargo area

### Storage compartment

A storage compartment is located on the left side.

### Lashing eyes in the cargo area

To secure the cargo, refer to page 172, there are four lashing eyes in the cargo area.

### Floor net

The floor net can also be used to Secure the load, refer to page 172, and to store small parts.



# امداد خودرو فارما

تلفن شبانه روزی: ۰۲۱-۸۸۸۶۲۰۸۵

[FarmaSOS.com](http://FarmaSOS.com)

## Driving tips

This chapter provides you with information useful in dealing with specific driving and operating modes.

امداد خودرو فارما

تلفن شبانه روزی: ۰۲۱-۸۸۸۶۲۰۸۵

FarmaSOS.com

# Things to remember when driving

## Vehicle features and options

This chapter describes all standard, country-specific and optional features offered with the series. It also describes features that are not necessarily available in your car, e. g., due to the selected options or country versions. This also applies to safety-related functions and systems.

## Breaking-in period

### General information

Moving parts need time to adjust to one another (break-in time).

The following instructions will help accomplish a long vehicle life and good efficiency.

During break-in, do not use the Launch Control, refer to page 74.

### Engine, transmission, and axle drive

Always obey the official speed limit.

#### Up to 1,200 miles/2,000 km

Do not exceed the maximum engine and road speed:

- ▷ For gasoline engine 4,500 rpm and 100 mph/160 km/h.

Avoid full load or kickdown under all circumstances.

#### From 1,200 miles/2,000 km

The engine and vehicle speed can gradually be increased.

### Tires

Tire traction is not optimal due to manufacturing circumstances when tires are brand-new; they achieve their full traction potential after a break-in time.

Drive conservatively for the first 200 miles/300 km.

### Brake system

Brakes require an initial break-in period of approx. 300 miles/500 km to achieve optimal performance between brake discs and brake pads. Drive moderately during this break-in period.

### Following part replacement

The same break-in procedures should be observed if any of the components above-mentioned have to be renewed in the course of the vehicle's operating life.

## General driving notes

### Closing the trunk lid



Drive with the trunk lid closed

Only drive with the tailgate closed; otherwise, in the event of an accident or braking and evasive maneuvers, passengers and other traffic may be injured, and the vehicle may be damaged. In addition, exhaust fumes may enter the vehicle interior. ◀

If driving with the tailgate open cannot be avoided:

- ▷ If the hardtop is closed, close all windows.
- ▷ Greatly increase the air flow from the vents.
- ▷ Drive moderately.

### Hot exhaust system



Hot exhaust system

High temperatures are generated in the exhaust system.

Do not remove the heat shields installed and never apply undercoating to them. Make sure that flammable materials, e. g. hay, leaves, grass, etc. do not come in contact with the hot exhaust system while driving, while in idle position mode, or when parked. Such contact could lead to a fire, resulting in an increased risk of serious personal injury as well as property damage.

Do not touch hot exhaust pipes; otherwise, there is a danger of getting burned. ◀

### Mobile communication devices in the vehicle

 Mobile communication devices in the vehicle

It is not recommended to use mobile phones, such as mobile phones, in the vehicle interior without a direct connection to an external aerial. Otherwise, the vehicle's electronics and mobile communication devices can interfere with each other. In addition, there is no assurance that the radiation generated during transmission will be conducted away from the vehicle interior. ◀

### Hydroplaning

 Hydroplaning

When driving on wet or slushy roads, reduce your speed to prevent hydroplaning. ◀

On wet or slushy roads, a wedge of water can form between the tires and road surface.

This phenomenon is referred to as hydroplaning. It is characterized by a partial or complete loss of contact between the tires and the road surface, ultimately undermining your ability to steer and brake the vehicle.

### Driving through water

 Observe water level and speed

Do not exceed the maximum water level and maximum speed; otherwise, the vehicle's engine, the electrical systems and the transmission may be damaged. ◀

Drive through calm water only and only if it is not deeper than 9.8 inches/25 cm and at this height, no faster than walking speed, up to 3 mph/5 km/h.

### Braking safely

Your vehicle is equipped with ABS as a standard feature.

Applying the brakes fully is the most effective way of braking in situations needed.

Steering is still responsive. You can still avoid any obstacles with a minimum of steering effort.

Pulsation of the brake pedal and sounds from the hydraulic circuits indicate that ABS is in its active mode.

In certain braking situations, the perforated brake discs can cause functional problems. However, this has no effect on the performance and operational reliability of the brake.

### Objects within the range of movement of the pedals

 No objects in the area around the pedals

Keep floor mats, carpets, and any other objects out of the pedal area; otherwise, the function of the pedals could be impeded while driving and create the risk of an accident.

Do not place additional floor mats over existing mats or other objects.

Only use floor mats that have been approved for the vehicle and can be properly attached to floor.

Ensure that the floor mats are securely fastened again after they were removed for cleaning, e.g. ◀

### Driving in wet conditions

When roads are wet, salted, or in heavy rain, press brake pedal ever so gently every few miles.

Ensure that this action does not endanger other traffic.

The heat generated in this process helps dry the brake discs and pads.

In this way braking efficiency will be available when you need it.

### Hills

 Avoid stressing the brakes

Avoid placing excessive stress on the brake system. Light but consistent brake pressure can lead to high temperatures, brakes wearing out and possibly even brake failure. ◀

 Do not drive in neutral

Do not drive in neutral or with the engine stopped, as doing so disables engine braking. In addition, steering and brake assist are unavailable with the engine stopped. ◀

Drive long or steep downhill gradients in the gear that requires least braking efforts. Otherwise the brakes may overheat and reduce brake efficiency.

You can increase the engine's braking effect by shifting down, going all the way to first gear, if needed.

### Brake disc corrosion

Brake disc corrosion and contamination of the brake pads are favored by:

- ▷ Low mileage.
- ▷ Extended periods when the vehicle is not used at all.
- ▷ Infrequent use of the brakes.

Corrosion will built up when the maximum pressure applied to the brake pads during braking is not reached - thus discs don't get cleaned.

Corrosion buildup on the brake discs will cause a pulsating effect on the brakes in their response - generally that cannot be corrected.

### Condensation under the parked vehicle

When using the automatic climate control, condensation water develops collecting underneath the vehicle.

These traces of water under the vehicle are normal.

امداد خودرو فارما

تلفن شبانه روزی: ۰۸۵-۲۶۲۰۸۸۸۶۲

FarmaSOS.com

# Loading

## Vehicle features and options

This chapter describes all standard, country-specific and optional features offered with the series. It also describes features that are not necessarily available in your car, e. g., due to the selected options or country versions. This also applies to safety-related functions and systems.

## Hints



**Overloading the vehicle**

To avoid exceeding the approved capacity of the tires, never overload the vehicle. Overloading can lead to overheating and increases the rate at which damage develops inside the tires. This could result in a sudden loss of tire inflation pressure. ◀



**No fluids in the cargo area**

Make sure that fluids do not leak into the cargo area; otherwise, the vehicle may be damaged. ◀



**Heavy and hard objects**

Do not stow any heavy and hard objects in the car's interior without securing them; otherwise, they may present a danger to occupants, e.g., during braking and evasive maneuvers. ◀



**Loading with hardtop open**

Before opening the hardtop, fold down the cargo area partition and make sure the loading is correct. Otherwise, parts of the hardtop can be damaged. ◀

## Determining the load limit

1. Locate the following statement on your vehicle's placard:
  - ▶ The combined weight of occupants and cargo should never exceed XXX kg or YYY lbs. Otherwise, damage to the vehicle and unstable driving situations may result.

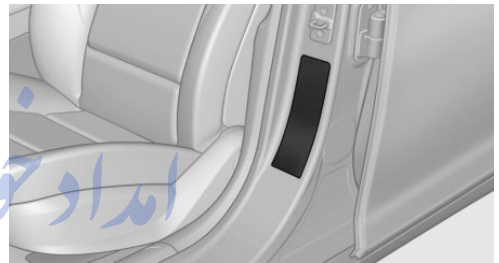

2. Determine the combined weight of the driver and passengers that will be riding in your vehicle.
3. Subtract the combined weight of the driver and passengers from XXX kilograms or YYY pounds.
4. The resulting figure equals the available amount of cargo and luggage load capacity.

For example, if the YYY amount equals 1,000 lbs and there will be four 150 lbs passengers in your vehicle, the amount of available cargo and luggage load capacity is 400 lbs: 1,000 lbs minus 600 lbs = 400 lbs.

5. Determine the combined weight of luggage and cargo being loaded on the vehicle. That weight may not safely exceed the available cargo and luggage load capacity calculated in Step 4.

## Load

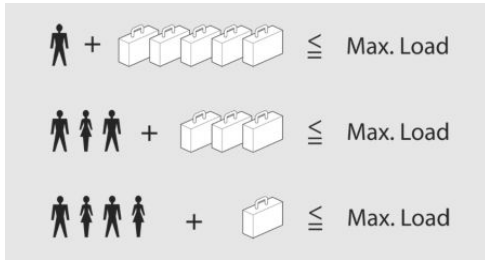

The maximum load is the sum of the weight of the occupants and the cargo.

The greater the weight of the occupants, the less cargo that can be transported.

## Stowing cargo

- ▷ Cover sharp edges and corners on the cargo.
- ▷ Heavy cargo: stow as far forward as possible, directly behind and at the bottom of the rear passenger seat backrests.
- ▷ Very heavy cargo: when the rear seat is not occupied, secure each of the outer safety belts in the opposite buckle.
- ▷ If necessary, fold down the rear backrests to stow cargo.
- ▷ Use loading aid, refer to page 160, for easier loading.
- ▷ Using the cargo area, refer to page 47.
- ▷ Do not stack cargo above the top edge of the backrests.

## Securing cargo

### Lashing eyes in the cargo area

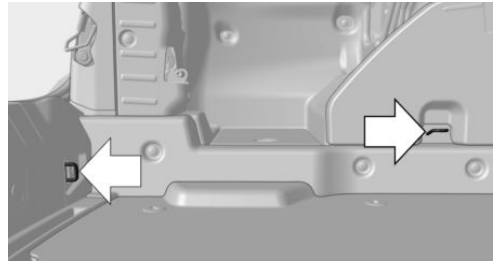

To secure the cargo there are four lashing eyes in the cargo area.

### Floor net

The floor net can also be used to secure the load and to store small parts.

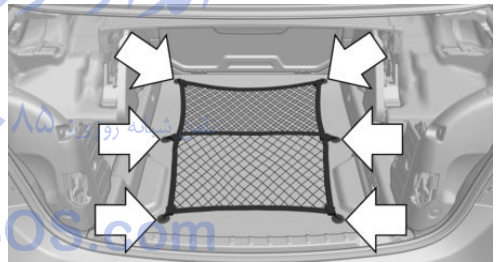

Hook the floor net into the fittings in the cargo area floor.

### Securing cargo

- ▷ Smaller and lighter items: secure with retaining straps or draw straps.
- ▷ Larger and heavy objects: secure with cargo straps.

Attach the cargo straps, retaining straps or draw straps to the lashing eyes in the cargo area.





### Securing cargo

Stow and secure the cargo as described above; otherwise it may present a danger to the occupants, e.g., during braking and evasive maneuvers. ◀

امداد خودرو فارما

تلفن شبانه روزی: ۰۲۱-۸۸۸۶۲۰۸۵

FarmaSOS.com

# Saving fuel

## Vehicle features and options

This chapter describes all standard, country-specific and optional features offered with the series. It also describes features that are not necessarily available in your car, e. g., due to the selected options or country versions. This also applies to safety-related functions and systems.

## General information

Your vehicle contains advanced technology for the reduction of fuel consumption and emissions.

Fuel consumption depends on a number of different factors.

Carrying out certain measures, such as a moderate driving style and regular maintenance, can influence fuel consumption and the environmental impact.

## Remove unnecessary cargo

Additional weight increases fuel consumption.

## Remove attached parts following use

Attached parts on the vehicle impair the aerodynamics and increase the fuel consumption.

## Closing the windows

Open windows increase air resistance and therefore lead to greater fuel consumption.

## Tires

### General information

Tires can affect fuel consumption in various ways, e.g., tire size may influence fuel consumption.

### Check the tire inflation pressure regularly

Check and, if needed, correct the tire inflation pressure at least twice a month and before starting on a long trip.

Low tire inflation pressure increases rolling resistance and thus raises fuel consumption and tire wear.

### Drive away immediately

Do not wait for the engine to warm-up while the vehicle remains stationary. Start driving right away, but at moderate engine speeds.

This is the quickest way of warming the cold engine up to operating temperature.

### Look well ahead when driving

Avoid unnecessary acceleration and braking.

By maintaining a suitable distance to the vehicle driving ahead of you.

Driving smoothly and proactively reduces fuel consumption.

### Avoid high engine speeds

As a rule: driving at low engine speeds lowers fuel consumption and reduces wear.

Use 1st gear to get the vehicle moving. Start-ing with the 2nd gear, accelerate rapidly. When

accelerating, shift up before reaching high engine speeds.

When you reach the desired speed, shift into the highest applicable gear and drive with the engine speed as low as possible and at a constant speed.

If necessary, observe the gear shift indicator of the vehicle, refer to page 83.

## Use coasting

When approaching a red light, take your foot off the accelerator and let the vehicle coast to a halt.

For going downhill take your foot off the accelerator and let the vehicle roll.

The flow of fuel is interrupted while coasting.

## Switch off the engine during longer stops

Switch off the engine during longer stops, e.g., at traffic lights, railroad crossings or in traffic congestion.

### Auto Start/Stop function

The Auto Start/Stop function of your vehicle automatically switches off the engine during a stop.

If the engine is switched off and then restarted rather than leaving the engine running constantly, fuel consumption and emissions are reduced. Savings can begin within a few seconds of switching off the engine.

In addition, fuel consumption is also determined by other factors, such as driving style, road conditions, maintenance or environmental factors.

## Switch off any functions that are not currently needed

Functions such as seat heating and the rear window defroster require a lot of energy and reduce the range, especially in city and stop-and-go traffic.

Reel off these functions if they are not needed.

The ECO PRO driving program supports the energy conserving use of comfort features.

These functions are automatically deactivated partially or completely.

## Have maintenance carried out

Have vehicles maintained regularly to achieve optimal vehicle efficiency and operating life.

The maintenance should be carried out by your service center.

Also note the BMW Maintenance System, refer to page 204.

## ECO PRO

### The concept

ECO PRO supports a driving style that saves on fuel consumption. For this purpose, the engine control and comfort features, e. g. the climate control output, are adjusted.

Under certain conditions the engine is automatically decoupled from the transmission in the D selector lever position. The vehicle continues traveling with the engine idling to reduce fuel consumption. Selector lever position D remains engaged.

In addition, context-sensitive instructions are displayed to assist with an optimized fuel consumption driving style.

The achieved extended range is displayed in the instrument cluster as bonus range.

## At a glance

The system includes the following EfficientDynamics functions and displays:

- ▷ ECO PRO bonus range, refer to page 176.
- ▷ ECO PRO tips driving instruction, refer to page 177
- ▷ ECO PRO climate control, refer to page 176.
- ▷ ECO PRO coasting driving status, refer to page 178.
- ▷ ECO PRO driving style analysis, refer to page 179.

## Activate ECO PRO

 Press button repeatedly until ECO PRO is displayed in the instrument cluster.

## Configuring ECO PRO

### Via the Driving Dynamics Control

1. Activate ECO PRO.
2. "Configure ECO PRO"
3. Configure the program.

### Via the iDrive

1. "Settings"
2. "ECO PRO mode"

Or

1. "Settings"
2. "Driving mode"
3. "Configure ECO PRO"

Configure the program.

## ECO PRO Tip

- ▷ "Tip at:":  
Adjust the ECO PRO speed.
- ▷ "ECO PRO speed warning":  
The output is reduced once the set ECO PRO speed is reached.

## Coasting

Fuel-efficiency can be optimized by disengaging the engine and Coasting, refer to page 178, with the engine idling.

This function is only available in ECO PRO mode.

## ECO PRO climate control

"ECO PRO climate control"

Climate control is set to be fuel-efficient.

By making a slight change to the set temperature, or slowly adjusting the rate of heating or cooling of the car's interior, fuel consumption can be economized.

The mirror heating is made available when outside temperatures are very cold.

## ECO PRO potential

Shows potential savings with the current settings in percentages.

## Display in the instrument cluster

### ECO PRO bonus range

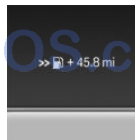

An adjusted driving style helps you extend your driving range.

This may be displayed as the bonus range in the instrument cluster.

The bonus range is shown in the range display.

The bonus range is automatically reset every time the vehicle is refueled.

## Driving style

Display in the instrument cluster

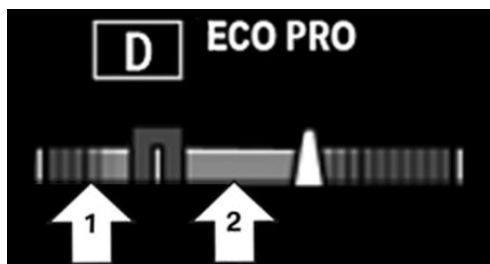

Display in the instrument cluster with expanded scope.

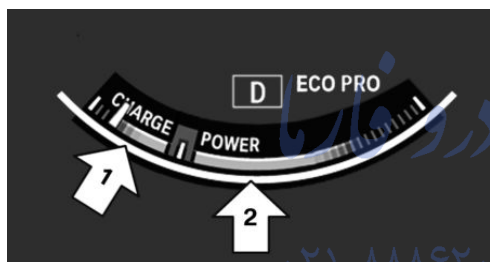

A bar display in the instrument cluster indicates your current driving efficiency.

Mark in the area of arrow 1: display of the energy recovered by coasting or when braking.

Mark in the area of arrow 2: display when accelerating.

Your driving style's efficiency is shown by the bar's color:

- ▶ Blue display: efficient driving style as long as the mark moves within the blue range.
- ▶ Gray display: adjust driving style, e. g. by backing off the accelerator pedal.

The display switches to blue as soon as all conditions for fuel-efficiency-optimized driving are met.

## ECO PRO tip, driving tip



The arrow indicates that the driving style can be adjusted to be more fuel efficient by backing off the accelerator for instance.

### Note

The driving style display and ECO PRO tips in the instrument cluster appear when the ECO PRO display is activated.

Activating driving style and ECO PRO tips:

1. "Settings"
2. "Instrument cluster"
3. "ECO PRO Info"

## ECO PRO tip, symbols

An additional symbol and text instructions are displayed.

| Symbol   | Measure   |
|--|---|
|   | For efficient driving back off the accelerator or delay accelerating to allow time to assess road conditions. |
|   | Reduce speed to the selected ECO PRO speed.   |
|  | Steptronic transmission: shift from M/S to D.   |



For efficient driving back off the accelerator or delay accelerating to allow time to assess road conditions.



Reduce speed to the selected ECO PRO speed.



Steptronic transmission: shift from M/S to D.

## Indications on the Control Display

### EfficientDynamics

Information on fuel consumption and technology can be displayed while driving.

1. "Vehicle info"
2. "EfficientDynamics"

## Displaying fuel consumption history

The average fuel consumption can be displayed within an adjustable time frame.

Vertical bars show consumption for the selected time frame.

Trip interruptions are represented below the bar on the time axis.

 "Consumption history"

### Adjusting fuel consumption history time frame

 Select the symbol.

### Resetting fuel consumption history

1. Open "Options".
2. "Reset consumption history"

### Displaying EfficientDynamics info

The current efficiency can be displayed.

 "EfficientDynamics info"

The following systems are displayed:

- ▷ Automatic engine Start/Stop function.
- ▷ Energy recovery.
- ▷ Climate control output.
- ▷ Coasting.

### Display ECO PRO tips

 "ECO PRO Tips"

Settings are stored for the profile currently in use.

## Coasting

### The concept

The system helps to conserve fuel.

To do this, under certain conditions the engine is automatically decoupled from the transmission when selector lever position D is set. The vehicle continues traveling with the engine idling to reduce fuel consumption. Selector lever position D remains engaged.

This driving condition is referred to as coasting.

As soon as you step on the brake or accelerator pedal, the engine is automatically coupled again.

### Hints

Coasting is a component of the ECO PRO, refer to page 175, driving mode.

Coasting is automatically activated when ECO PRO mode is called via the Driving Dynamics Control.

The function is available in a certain speed range.

A proactively driving style helps the driver to use the function as often as possible and supports the fuel-conserving effect of coasting.

### Safety mode

The function is not available under one of the following conditions.

- ▷ DSC OFF or TRACTION activated.
- ▷ Driving in the dynamic limit range and on steep uphill or downhill grades.
- ▷ Battery charge status temporarily too low or vehicle electrical system drawing excessive current.
- ▷ Cruise control activated.

### Functional requirements

In ECO PRO mode, this function is available in a speed range from approximately 30 mph, approx. 50 km/h to 100 mph, approx. 160 km/h, if the following conditions are met:

- ▷ Accelerator pedal and brake pedal are not operated.
- ▷ The selector lever is in selector lever position D.
- ▷ Engine and transmission are at operating temperature.

The driving status Coast can be influenced with the shift paddles.

## Display

### Display in the instrument cluster

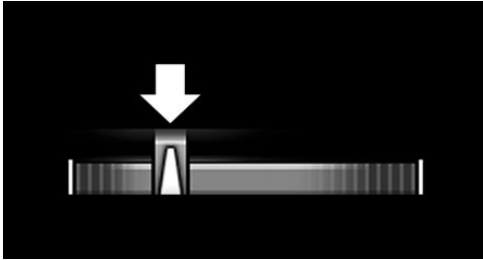

The mark in the bar display is backlit in blue and is located at the zero point. The tachometer approximately indicates idle speed.

The coasting point indicator is illuminated at the zero point during coasting.

### Display in the instrument cluster with extended range

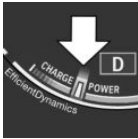

The mark in the bar display below the tachometer is backlit in blue and is located at the zero point. The tachometer approximately indicates idle speed.

The coasting point indicator is illuminated at the zero point during coasting.

### Indications on the Control Display

The Coasting driving condition is displayed in EfficientDynamics Info while this driving mode is active.

The distance traveled in the Coasting driving condition is indicated by a counter.

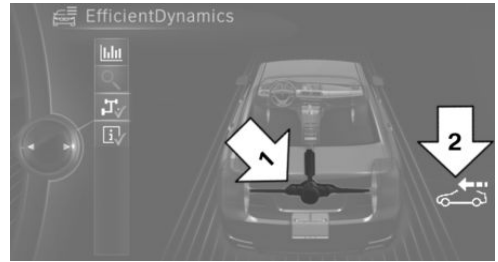

Color code blue, arrow 1, and symbol, arrow 2: driving condition Coasting.

### Displaying EfficientDynamics info

1. "Vehicle info"
2. "EfficientDynamics"
3.  "EfficientDynamics info"

### Deactivating the system manually

The function can be deactivated in the Configure ECO PRO, refer to page 176, menu, e.g., to use the braking effect of the engine when traveling downhill.

Settings are stored for the profile currently in use.

### ECO PRO driving style analysis

#### The concept

In this situation the system helps develop an especially efficient driving style and to conserve fuel.

For this purpose, the driving style is analyzed. The assessment is done in various categories and is displayed on the Control Display.

Using this indication, the individual driving style can be oriented toward conserving fuel.

The last fifteen minutes of a trip are evaluated.

The range of the vehicle can be extended by an efficient driving style.

This gain in range is displayed as a bonus range in the instrument cluster and on the Control Display.

## Functional requirement

The function is only available in ECO PRO mode.

## Calling up ECO PRO driving style analysis

1. Activate ECO PRO.
2. "EfficientDynamics"
3.  Select the symbol.

## Display on the Control Display

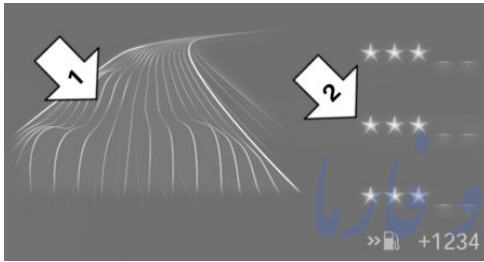

The display of the ECO PRO driving style analysis consists of a symbolized route and a lookup table.

The road symbolizes the efficiency of the driving style. The more efficient the driving style, the smoother the depicted route becomes, arrow 1.

The table of values contains stars. The more efficient the driving style, the more stars are included in the table and the faster the bonus range increases, arrow 2.

If, on the other hand, the driving style is inefficient, a wavy road and a reduced number of stars is displayed.

To assist with an efficient driving style, ECO PRO tips are displayed during driving.

Tips about the energy saving driving style, Conserving fuel, refer to page 174.



# امداد خودرو فارما

تلفن شبانه روزی: ۰۲۱-۸۸۸۶۲۰۸۵

**FarmaSOS.com**



# امداد خودرو فارما

تلفن شبانه روزی: ۰۲۱-۸۸۸۶۲۰۸۵

[FarmaSOS.com](http://FarmaSOS.com)

## Mobility

In order to always ensure your mobility, you will find important information on operating fluids, wheels and tires, maintenance and Roadside Assistance in the following.

امداد خودرو فارما

تلفن شماره روزی: ۰۲۱-۸۸۸۶۲۰۸۵

[FarmaSOS.com](http://FarmaSOS.com)

# Refueling

## Vehicle features and options

This chapter describes all standard, country-specific and optional features offered with the series. It also describes features that are not necessarily available in your car, e. g., due to the selected options or country versions. This also applies to safety-related functions and systems.

## Hints



Refuel promptly

Refuel no later than at a range of 30 miles/50 km or engine operation might fail and damage might occur. ◀

## Fuel lid

### Opening

1. Briefly press the rear edge of the fuel filler flap.



2. Turn the tank lid counterclockwise.

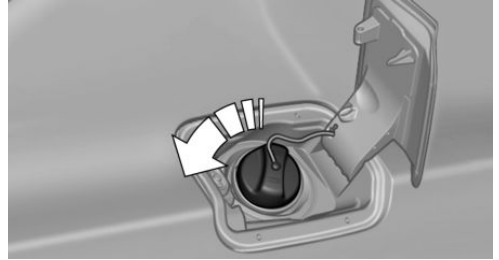

3. Place the tank lid in the bracket attached to the fuel filler flap.

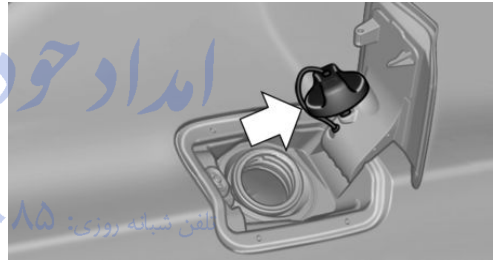

### Closing

1. Fit the lid and turn it clockwise until you clearly hear a click.
2. Close the fuel filler flap.



Do not pinch the retaining strap

Do not pinch the retaining strap attached to the lid; otherwise, the lid cannot be closed properly and fuel vapors can escape. ◀

### Manually unlocking fuel filler flap

In the event of an electrical malfunction, e.g. The release is located in the cargo area.

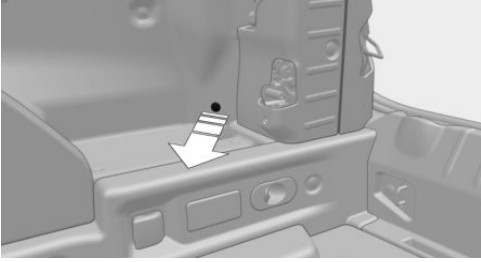

Pull the green knob with the fuel pump symbol. This releases the fuel filler flap.

## Observe the following when refueling

The fuel tank is full when the filler nozzle clicks off the first time.

 Do not overfill the fuel tank. Do not overfill the fuel tank; otherwise fuel may eslide, causing harm to the environment and damaging the vehicle.◀

 Handling fuels. Observe safety regulations posted at the gas station.◀

امداد خودرو فارما  
تلفن شبانه روزی: ۰۲۱-۸۸۸۶۲۰۸۵  
FarmaSOS.com

# Fuel

## Vehicle features and options

This chapter describes all standard, country-specific and optional features offered with the series. It also describes features that are not necessarily available in your car, e. g., due to the selected options or country versions. This also applies to safety-related functions and systems.

## Fuel recommendation

### Note

 General fuel quality  
Even fuels that conform to the specifications can be of low quality. This may cause engine problems, for instance poor engine start-up behavior, poor handling and/or poor performance. Switch gas stations or use a brand name fuel with a higher octane rating. ◀

### Gasoline

For the best fuel efficiency, the gasoline should be sulfur-free or very low in sulfur content.

Fuels that are marked on the gas pump as containing metal must not be used.

 Refuel only with unleaded gasoline without metallic additives.

Do not refuel with any leaded gasoline or gasoline with metallic additives, e. g. manganese or iron, as this can cause permanent damage to the catalytic converter and other components. ◀

Fuels with a maximum ethanol content of 10 %, i. e., E10, may be used for refueling.

Ethanol should satisfy the following quality standards:

US: ASTM 4806–xx

CAN: CGSB-3.511–xx

xx: comply with the current standard in each case.

 Do not use a fuel with a higher percentage of ethanol

Do not use a fuel with a higher ethanol percentage than recommended or one with other types of alcohol, e.g. M5 to M100; otherwise this could damage the engine and fuel supply system. ◀

### Recommended fuel grade

BMW recommends AKI 91.

### Minimum fuel grade

BMW recommends AKI 89.

 Minimum fuel grade  
Do not use any gasoline below the minimum fuel grade as this may impair engine performance. ◀

If you use gasoline with this minimum AKI Rating, the engine may produce knocking sounds when starting at high outside temperatures. This has no effect on the engine life.

 Fuel quality  
The use of poor-quality fuels may result in harmful engine deposits or damage. Additionally, problems relating to drivability, starting and stalling, especially under certain environmental conditions such as high ambient temperature and high altitude, may occur.

If drivability problems are encountered, we recommend switching to a high quality gasoline brand and a higher octane grade — AKI number — for a few tank fills. To avoid harmful engine deposits, it is highly recommended to purchase gasoline from BP or Top Tier retailers.

Failure to comply with these recommendations may result in the need for unscheduled maintenance. ◀

**BMW** recommends BP fuels 

امداد خودرو فارما

تلفن شبانه روزی: ۰۲۱-۸۸۸۶۲۰۸۵

[FarmaSOS.com](http://FarmaSOS.com)

# Wheels and tires

## Vehicle features and options

This chapter describes all standard, country-specific and optional features offered with the series. It also describes features that are not necessarily available in your car, e. g., due to the selected options or country versions. This also applies to safety-related functions and systems.

## Tire inflation pressure

### Safety information

The tire characteristics and tire inflation pressure influence the following:

- ▷ The service life of the tires.
- ▷ Road safety.
- ▷ Driving comfort.

### Checking the tire inflation pressure

 Check the tire inflation pressure regularly

Regularly check the tire inflation pressure, and correct it as needed: at least twice a month and before a long trip. If you fail to observe this precaution, you may be driving on tires with incorrect tire pressures, a condition that may not only compromise your vehicle's driving stability, but also lead to tire damage and the risk of an accident. ◀

Tires have a natural, consistent loss of tire inflation pressure.

Tires heat up while driving, and the tire inflation pressure increases along with the tire's temperature. The tire inflation pressure specifications relate to cold tires or tires with the ambient temperature.

Only check the tire inflation pressure when the tires are cold. This means after driving no more

than 1.25 miles/2 km or when the vehicle has been parked for at least 2 hours.

The displays of inflation devices may under-read by up to 1.45 psi/0.1 bar.

For Flat Tire Monitor: after correcting the tire inflation pressure, reinitialize the Flat Tire Monitor.

For Tire Pressure Monitor: after correcting the tire inflation pressure, reset the Tire Pressure Monitor.

### Tire inflation pressure specifications

The tire inflation pressure table, refer to page 189, contains all tire inflation pressure specifications for the specified tire sizes at the ambient temperature. Tire inflation pressure specifications apply to approved tire sizes and recommended tire brands. This information can be obtained from your service center.

To identify the correct tire inflation pressure, please note the following:

- ▷ Tire sizes of your vehicle.
- ▷ Maximum permitted driving speed.

### Tire inflation pressures up to 100 mph/160 km/h

For speeds of up to 100 mph/160 km/h and for optimum driving comfort, note the pressure values in the tire inflation pressure table, refer to page 189, and adjust as necessary.





These pressure values can also be found on the tire inflation pressure label on the driver's door pillar.



Maximum permissible speed

Do not exceed 100 mph/160 km/h; otherwise, tire damage and accidents may result. ◀

### Tire inflation pressure values up to 100 mph/160 km/h

#### 428i, 428i xDrive

| Tire size                                 | Pressure specifications in bar/PSI |          |
|---|------------------------------------|----------|
| Specifications in bar/PSI with cold tires |                                    |          |
| 225/50 R 17 94 H M+S RSC                  | 2.2 / 32                           | 2.7 / 39 |
| 225/50 R 17 94 V M+S A/S RSC              |                                    |          |
| 225/45 R 18 91 V M+S A/S RSC              |                                    |          |
| 225/45 R 18 91 Y RSC                      |                                    |          |
| 225/45 R 18 95 V M+S XL RSC               |                                    |          |
| 225/40 R 19 93 V M+S XL A/S RSC           | 2.5 / 36                           | 3.0 / 44 |

| Tire size                            | Pressure specifications in bar/PSI     |          |
|--------------------------------------|--|----------|
| Front: 225/45 R 18 91 Y RSC          | 2.2 / 32                               | -        |
| Rear: 255/40 R 18 95 Y RSC           | -                                      | 2.4 / 35 |
| Front: 225/40 R 19 89 Y RSC          | 2.4 / 35                               | -        |
| Rear: 255/35 R 19 92 Y RSC           | -                                      | 2.7 / 39 |
| Front: 225/35 R 20 90 Y XL RSC       | 2.6 / 38                               | -        |
| Rear: 255/30 R 20 92 Y XL RSC        | -                                      | 3.1 / 45 |
| Emergency wheel: T 135/80 R 17 102 M | Speed up to a max. of 50 mph / 80 km/h | 4.2 / 60 |

#### 435i, 435i xDrive

| Tire size                                 | Pressure specifications in bar/PSI |          |
|---|------------------------------------|----------|
| Specifications in bar/PSI with cold tires |                                    |          |
| 225/50 R 17 94 H M+S RSC                  | 2.2 / 32                           | 2.7 / 39 |
| 225/45 R 18 91 V M+S A/S RSC              |                                    |          |
| 225/45 R 18 91 Y RSC                      |                                    |          |
| 225/45 R 18 95 V M+S XL RSC               |                                    |          |
| 225/40 R 19 93 V M+S XL A/S RSC           | 2.5 / 36                           | 3.0 / 44 |

| Tire size                                  | Pressure specifications in bar/PSI                    |          |
|--|---|----------|
| Front: 225/45 R 18<br>91 Y RSC             | 2.2 / 32  | -        |
| Rear: 255/40 R 18<br>95 Y RSC              | -   | 2.4 / 35 |
| Front: 225/40 R 19<br>89 Y RSC             | 2.4 / 35  | -        |
| Rear: 255/35 R 19<br>92 Y RSC              | -   | 2.7 / 39 |
| Front: 225/35 R 20<br>90 Y XL RSC          | 2.7 / 39  | -        |
| Rear: 255/30 R 20<br>92 Y XL RSC           | -   | 3.2 / 46 |
| Emergency wheel:<br>T 135/80 R 17 102<br>M | Speed up to a max. of<br>50 mph / 80 km/h<br>4.2 / 60 |          |

### Tire inflation pressures at max. speeds above 100 mph/160 km/h

 Speeds above 100 mph/160 km/h  
In order to drive at maximum speeds in excess of 100 mph/160 km/h, please observe, and, if necessary, adjust tire pressures for speeds exceeding 100 mph/160 km/h from the relevant table on the following pages. Otherwise tire damage and accidents could occur. ◀

### Tire inflation pressure values over 100 mph/160 km/h

#### 428i, 428i xDrive

Without high-speed tuning feature

| Tire size                                  | Pressure specifications in bar/PSI  |          |
|--|---|----------|
| Specifications in bar/PSI with cold tires  |  |          |
| 225/50 R 17 94 H<br>M+S RSC                | 2.6 / 38  | 3.1 / 45 |
| 225/50 R 17 94 V<br>M+S A/S RSC            |   |          |
| 225/45 R 18 91 V<br>M+S A/S RSC            |   |          |
| 225/45 R 18 91 Y<br>RSC                    |   |          |
| 225/45 R 18 95 V<br>M+S XL RSC             | 2.9 / 42  | 3.4 / 49 |
| 225/40 R 19 93 V<br>M+S XL A/S RSC         |   |          |
| Front: 225/45 R 18<br>91 Y RSC             | 2.6 / 38  | -        |
| Rear: 255/40 R 18<br>95 Y RSC              | -   | 2.8 / 41 |
| Front: 225/40 R 19<br>89 Y RSC             | 2.8 / 41  | -        |
| Rear: 255/35 R 19<br>92 Y RSC              | -   | 3.1 / 45 |
| Front: 225/35 R 20<br>90 Y XL RSC          | 3.0 / 44  | -        |
| Rear: 255/30 R 20<br>92 Y XL RSC           | -   | 3.5 / 51 |
| Emergency wheel:<br>T 135/80 R 17 102<br>M | Speed up to a max. of<br>50 mph / 80 km/h<br>4.2 / 60                             |          |

With high-speed tuning feature

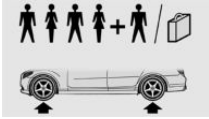
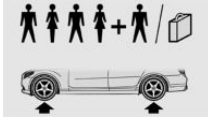
| Tire size                                 | Pressure specifications in bar/PSI  |          | Tire size                                 | Pressure specifications in bar/PSI   |          |
|---|---|----------|---|--|----------|
| Specifications in bar/PSI with cold tires |  |          | Specifications in bar/PSI with cold tires |  |          |
| 225/50 R 17 94 H M+S RSC                  | 2.6 / 38  | 3.1 / 45 | 225/50 R 17 94 H M+S RSC                  | 2.6 / 38   | 3.1 / 45 |
| 225/45 R 18 91 Y RSC                      |   |          | 225/45 R 18 91 V M+S A/S RSC              |  |          |
| 225/45 R 18 95 V M+S XL RSC               | 2.9 / 42  | 3.4 / 49 | 225/45 R 18 91 Y RSC                      |  |          |
| Front: 225/45 R 18 91 Y RSC               | 2.6 / 38  | -        | 225/45 R 18 95 V M+S XL RSC               | 2.9 / 42   | 3.4 / 49 |
| Rear: 255/40 R 18 95 Y RSC                | -   | 2.8 / 41 | 225/40 R 19 93 V M+S XL A/S RSC           |  |          |
| Front: 225/40 R 19 89 Y RSC               | 2.8 / 41  | -        | Front: 225/45 R 18 91 Y RSC               | 2.6 / 38   | -        |
| Rear: 255/35 R 19 92 Y RSC                | -   | 3.1 / 45 | Rear: 255/40 R 18 95 Y RSC                | -  | 2.8 / 41 |
| Front: 225/35 R 20 90 Y XL RSC            | 3.0 / 44  | -        | Front: 225/40 R 19 89 Y RSC               | 2.8 / 41   | -        |
| Rear: 255/30 R 20 92 Y XL RSC             | -   | 3.5 / 51 | Rear: 255/35 R 19 92 Y RSC                | -  | 3.1 / 45 |
| Emergency wheel: T 135/80 R 17 102 M      | Speed up to a max. of 50 mph / 80 km/h  |          | Front: 225/35 R 20 90 Y XL RSC            | 3.0 / 44   | -        |
|   | 4.2 / 60  |          | Rear: 255/30 R 20 92 Y XL RSC             | -  | 3.5 / 51 |
|   |   |          | Emergency wheel: T 135/80 R 17 102 M      | Speed up to a max. of 50 mph / 80 km/h   |          |
|   |   |          |   | 4.2 / 60   |          |

### 435i, 435i xDrive

Without high-speed tuning feature

With high-speed tuning feature

**Tire size**      **Pressure specifications in bar/PSI**

Specifications in bar/PSI with cold tires

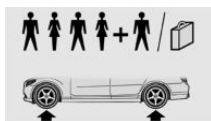

225/45 R 18 91 Y RSC      2.6 / 38      3.1 / 45

225/50 R 17 94 H M+S RSC

225/45 R 18 95 V M+S XL RSC      2.9 / 42      3.4 / 49

Front: 225/45 R 18 91 Y RSC      2.6 / 38      -  
 Rear: 255/40 R 18 95 Y RSC      -      2.8 / 41

Front: 225/40 R 19 89 Y RSC      2.8 / 41      -  
 Rear: 255/35 R 19 92 Y RSC      -      3.1 / 45

Front: 225/35 R 20 90 Y XL RSC      3.0 / 44      -  
 Rear: 255/30 R 20 92 Y XL RSC      -      3.5 / 51

Emergency wheel: T 135/80 R 17 102 M      Speed up to a max. of 50 mph / 80 km/h  
 M      4.2 / 60

## Tire identification marks

### Tire size

245/45 R 18 96 Y

245: nominal width in mm

45: aspect ratio in %

R: radial tire code

18: rim diameter in inches

96: load rating, not for ZR tires

Y: speed rating, before the R on ZR tires

### Speed letter

Q = up to 100 mph, 160 km/h

R = up to 106 mph, 170 km/h

S = up to 112 mph, 180 km/h

T = up to 118 mph, 190 km/h

H = up to 131 mph, 210 km/h

V = up to 150 mph, 240 km/h

W = up to 167 mph, 270 km/h

Y = up to 186 mph, 300 km/h

الراد سودو فارما  
 ۰۲۱-۸۸۸۶۲۰۸۵ تلفن شبانه روزی

FarmaSOS.com

## Tire Identification Number

DOT code: DOT xxxx xxx 4314

xxxx: manufacturer code for the tire brand

xxx: tire size and tire design

4314: tire age

Tires with DOT codes meet the guidelines of the U.S. Department of Transportation.

## Tire age

DOT ... 4314: the tire was manufactured in the 43th week of 2014.

## Recommendation

Regardless of wear and tear, replace tires at least every 6 years.

## Uniform Tire Quality Grading

Quality grades can be found where applicable on the tire sidewall between tread shoulder and maximum section width.

For example: Treadwear 200; Traction AA; Temperature A

## DOT Quality Grades

Treadwear

Traction AA A B C

Temperature A B C

All passenger car tires must conform to Federal Safety Requirements in addition to these grades.

## Treadwear

The treadwear grade is a comparative rating based on the wear rate of the tire when tested under controlled conditions on a specified government test course. For example, a tire graded 150 would wear one and one-half, 1 g, times as well on the government course as a tire graded 100. The relative performance of tires depends upon the actual conditions of their use, however, and may depart significantly from the norm due to variations in driving habits, service practices and differences in road characteristics and climate.

## Traction

The traction grades, from highest to lowest, are AA, A, B, and C.

Those grades represent the tire's ability to stop on wet pavement as measured under controlled conditions on specified government test surfaces of asphalt and concrete. A tire marked C may have poor traction performance.

The traction grade assigned to this tire is based on straight-ahead braking traction tests, and does not include acceleration, cornering, hydroplaning, or peak traction characteristics.

## Temperature

The temperature grades are A, the highest, B, and C, representing the tire's resistance to the generation of heat and its ability to dissipate heat when tested under controlled conditions on a specified indoor laboratory test wheel. Sustained high temperature can cause the material of the tire to degenerate and reduce tire life, and excessive temperature can lead to

sudden tire failure. The grade C corresponds to a level of performance which all passenger car tires must meet under the Federal Motor Vehicle Safety Standard No. 109. Grades Band A represent higher levels of performance on the laboratory test wheel than the minimum required by law.



Temperature grade for this tire

The temperature grade for this tire is established for a tire that is properly inflated and not overloaded. Excessive speed, underinflation, or excessive loading, either separately or in combination, can cause heat buildup and possible tire failure.

If necessary, have the vehicle towed. ◀

### RSC – Run-flat tires

Run-flat tires, refer to page 196, are labeled with a circular symbol containing the letters RSC marked on the sidewall.

### M+S

Winter and all-season tires with better cold weather performance than summer tires.

## Tire tread

### Summer tires

Do not drive with a tire tread depth of less than 0.12 in/3 mm.

There is an increased danger of hydroplaning if the tire tread depth is less than 0.12 in/3 mm.

### Winter tires

Do not drive with a tire tread depth of less than 0.16 in/4 mm.

Below a tread depth of 0.16 in/4 mm, tires are less suitable for winter operation.

## Minimum tread depth

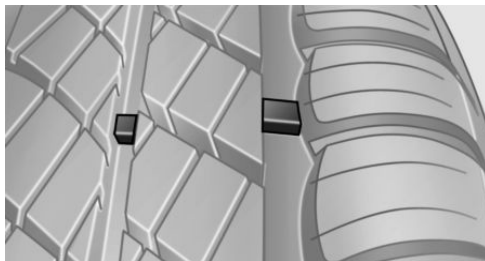

Wear indicators are distributed around the tire's circumference and have the legally required minimum height of 0.063 in/1.6 mm.

They are marked on the side of the tire with TWI, Tread Wear Indicator.

## Tire damage

### General information

Inspect your tires often for damage, foreign objects lodged in the tread, and tread wear.

### Hints

Driving over rough or damaged road surfaces, as well as debris, curbs and other obstacles can cause serious damage to wheels, tires and suspension parts. This is more likely to occur with low-profile tires, which provide less cushioning between the wheel and the road. Be careful to avoid road hazards and reduce your speed, especially if your vehicle is equipped with low-profile tires.

Indications of tire damage or other vehicle defects:

- ▷ Unusual vibrations while driving.
- ▷ Unusual handling such as a strong tendency to pull to the left or right.

Damage can, e. g., be caused by driving over curbs, road damage, or similar things.

**In case of tire damage**

If there are indications of tire damage, reduce your speed immediately and have the rims and tires checked right away; otherwise, there is the increased risk of an accident.

Drive carefully to the nearest service center. Have the vehicle towed or transported there.

Otherwise, tire damage can become life threatening for vehicle occupants and also other traffic. ◀

**Repair of tire damage**

For safety reasons, the manufacturer of your vehicle recommends that you do not have damaged tires repaired; they should be replaced. Otherwise, damage can occur as a result. ◀

## Changing wheels and tires

### Mounting

**Information on mounting tires**

Have mounting and balancing performed only by a service center.

If work is not carried out properly, there is a danger of subsequent damage and related safety hazards. ◀

### Wheel and tire combination

You can ask the service center about the right wheel/tire combination and wheel rim versions for the vehicle.

Incorrect wheel and tire combinations impair the function of a variety of systems such as ABS or DSC.

To maintain good handling and vehicle response, use only tires with a single tread configuration from a single manufacturer.

Following tire damage, have the original wheel and tire combination remounted on the vehicle as soon as possible.

**Approved wheels and tires**

You should only use wheels and tires that have been approved by the vehicle manufacturer for your vehicle type; otherwise, e.g., despite having the same official size ratings, variations can lead to chassis contact and with it, the risk of severe accidents

The manufacturer of your vehicle cannot evaluate non-approved wheels and tires to determine if they are suited for use, and therefore cannot guarantee the operating safety of the vehicle. ◀

### Recommended tire brands

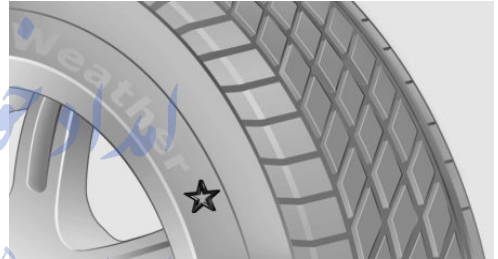

For each tire size, the manufacturer of your vehicle recommends certain tire brands. These can be identified by a star on the tire sidewall. With proper use, these tires meet the highest standards for safety and handling.

### New tires

Tire traction is not optimal due to manufacturing circumstances when tires are brand-new; they achieve their full traction potential after a break-in time.

Drive conservatively for the first 200 miles/300 km.

### Retreaded tires

The manufacturer of your vehicle does not recommend the use of retreaded tires.



### Retreaded tires

Possibly substantial variations in the design and age of the tire casing structures can limit service life and have a negative impact on road safety. ◀

## Winter tires

Winter tires are recommended for operating on winter roads.

Although so-called all-season M+S tires provide better winter traction than summer tires, they do not provide the same level of performance as winter tires.

### Maximum speed of winter tires

If the maximum speed of the vehicle is higher than the permissible speed for the winter tires, then a respective symbol is displayed in your field of vision. You can obtain this sign from the tire specialist or from your service center.



### Maximum speed for winter tires

Do not exceed the maximum speed for the respective winter tires; otherwise, tire damage and accidents can occur. ◀

## Run-flat tires

If you are already using run-flat tires, for your own safety you should replace them only with the same kind. No spare tire is available in the case of a flat tire. Your service center will be glad to advise you.

## Rotating wheels between axles

Different wear patterns can occur on the front and rear axles depending on individual driving conditions. The tires can be rotated between the axles to achieve even wear. Your service center will be glad to advise you. After rotating, check the tire pressure and correct if needed.

Rotating the tires is not permissible on vehicles with different tire sizes on the front and rear axles, i.e. when using different types of tires.

## Storage

Store wheels and tires in a cool, dry place with as little exposure to light as possible.

Always protect tires against all contact with oil, grease and fuels.

Do not exceed the maximum tire inflation pressure indicated on the side wall of the tire.

## Run-flat tires

### Label

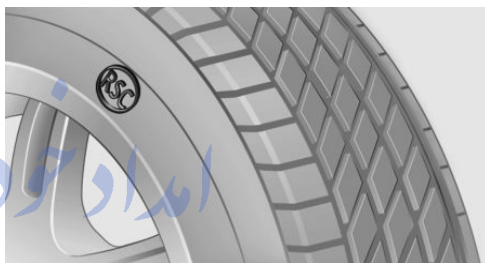

RSC label on the tire sidewall.

The wheels consist of tires that are self-supporting, to a limited degree, and possibly special rims.

The support of the sidewall allows the tire to remain drivable to a restricted degree in the event of a tire inflation pressure loss.

Follow the instructions for continued driving with a flat tire.

## Changing run-flat tires

For your own safety, only use run-flat tires. No spare tire is available in the case of a flat tire. Your service center will be glad to advise you.

## Snow chains

### Fine-link snow chains

Only certain types of fine-link snow chains have been tested by the manufacturer of the vehicle, classified as road-safe and approved.



Information about the approved snow chains are available from the service center.

## Use

Use only in pairs on the rear wheels, equipped with the tires of the following size:

- ▷ 225/50 R 17.
- ▷ 225/45 R 18.

Follow the snow chain manufacturer's instructions.

Make sure that the snow chains are always sufficiently tight. Retighten as needed according to the chain manufacturer's instructions.

Do not initialize the Flat Tire Monitor after mounting snow chains, as doing so may result in incorrect readings.

Do not initialize the Tire Pressure Monitor after mounting snow chains, as doing so may result in incorrect readings.

When driving with snow chains, briefly activate Dynamic Traction Control if needed.

## Maximum speed with snow chains

Do not exceed a speed of 30 mph/50 km/h when using snow chains.

امداد خودرو فارس  
تلفن شبانه روزی: ۰۲۶-۸۸۸۶۲۰۸۵  
FarmaSOS.com

# Engine compartment

## Vehicle features and options

This chapter describes all standard, country-specific and optional features offered with the series. It also describes features that are not

necessarily available in your car, e. g., due to the selected options or country versions. This also applies to safety-related functions and systems.

## Important features in the engine compartment

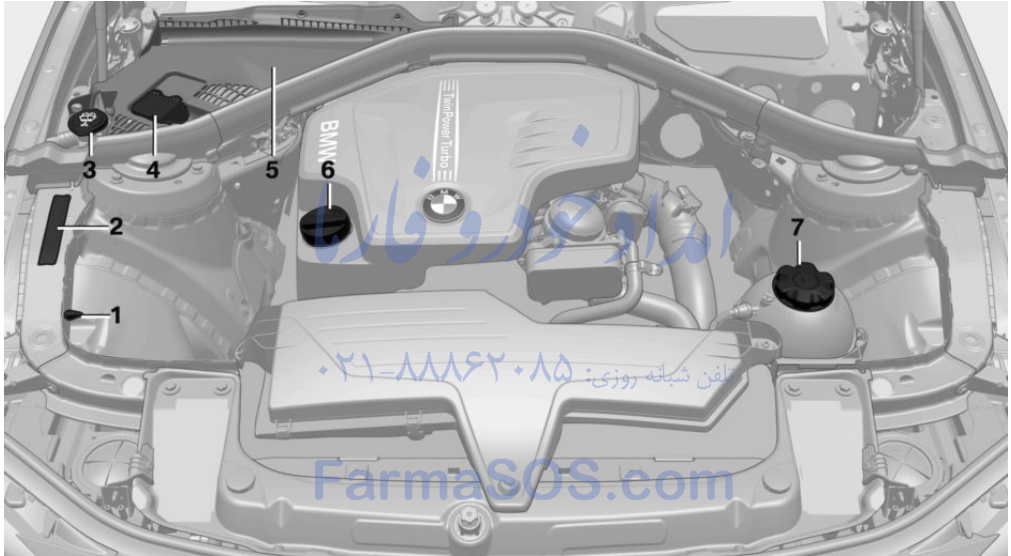

- 1 Jump-starting, negative battery terminal
- 2 Vehicle identification number
- 3 Washer fluid reservoir
- 4 Jump-starting, positive battery terminal
- 5 Engine compartment fuse box

- 6 Oil filler neck
- 7 Coolant reservoir

The coolant reservoir for 6-cylinder and diesel engines is located on the opposite side of the engine compartment.

## Hood

### Hints

 Working in the engine compartment  
Never attempt to perform any service or repair operations on your vehicle without the necessary professional technical training.

If you are unfamiliar with the statutory guidelines, have any work on the vehicle performed only by a service center.

If work is not carried out properly, there is a danger of subsequent damage and related safety hazards. ◀

 Never reach into the engine compartment

Never reach into spaces or gaps in the engine compartment; otherwise, there is a risk of injury, e.g., from rotating or hot parts. ◀

 Fold down wiper arm

Before opening the hood, ensure that the wiper arms are against the windshield, or this may result in damage. ◀

### Opening the hood

1. Pull lever, arrow 1.  
Hood is unlocked

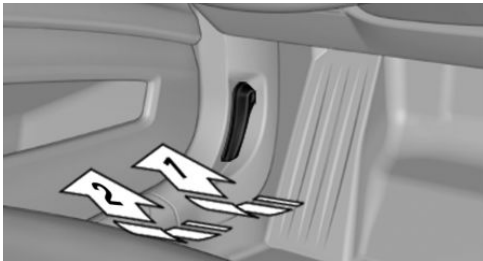



2. After the lever is released, pull the lever again, arrow 2.  
Hood can be opened.

### Indicator/warning lights

When the hood is opened, a Check Control message is displayed.

### Closing the hood

 Hood open when driving  
If you see any signs that the hood is not completely closed while driving, pull over immediately and close it securely. ◀

 Danger of jamming  
Make sure that the closing path of the hood is clear; otherwise, injuries may result. ◀

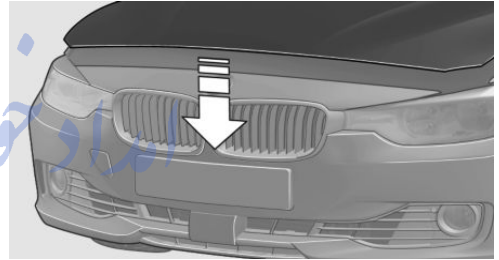

Let the hood drop from a height of approx. 16 in/40 cm and push down on it to lock it fully.

The hood must audibly engage on both sides.

FarmaSOS.com

# Engine oil

## Vehicle features and options

This chapter describes all standard, country-specific and optional features offered with the series. It also describes features that are not necessarily available in your car, e. g., due to the selected options or country versions. This also applies to safety-related functions and systems.

## General information

The engine oil consumption is dependent on the driving style and driving conditions.

The engine oil consumption can increase in case of, for example:

- ▷ Sporty driving.
- ▷ Break-in the engine.
- ▷ Idling of the engine.
- ▷ Usage of non-approved engine oil grades.

Therefore, regularly check the engine oil level after refueling.

The vehicle is equipped with electronic oil measurement.

The electronic oil measurement has two measuring principles:

- ▷ Status display
- ▷ Detailed measurement

## Electronic oil measurement

### Status display

#### The concept

The engine oil level is monitored electronically while driving and shown on the Control Display.

If the engine oil level reaches the minimum level, a check control message is displayed.

### Requirements

A current measured value is available after approx. 30 minutes of driving. During a shorter trip, the status of the last, sufficiently long trip is displayed.

With frequent short-distance trips, regularly perform a detailed measurement.

### Displaying the engine oil level

On the Control Display:

1. "Vehicle info"
2. "Vehicle status"
3. : "Engine oil level"

### Engine oil level display messages

Different messages appear on the display depending on the engine oil level. Pay attention to these messages.

If the engine oil level is too low, within the next 125 miles/200 km Add engine oil, refer to page 201.



Engine oil level too low

Add engine oil immediately; otherwise, an insufficient amount of engine oil could result in engine damage. ◀

Take care not to add too much engine oil.



Too much engine oil

Have the vehicle checked immediately; otherwise, surplus engine oil can lead to engine damage. ◀

## Detailed measurement

### The concept

In the detailed measurement the engine oil level is checked and displayed via a scale.

During the measurement, the idle speed is increased somewhat.

### General information

A detailed measurement is only possible with certain engines.

### Requirements

- Vehicle is on level road.
- Steptronic transmission: selector lever in selector lever position N or P and accelerator pedal not depressed.
- Engine is running and is at operating temperature.

### Performing a detailed measurement

In order to perform a detailed measurement of the engine oil level:

1. "Vehicle info"
2. "Vehicle status"
3.  "Measure engine oil level"
4. "Start measurement"

The engine oil level is checked and displayed via a scale.

Time: approx. 1 minute.

## Adding engine oil



### General information

Switch off the ignition and safely park the vehicle before engine oil is added.

## Oil filler neck





Only add 1 US quart/liter of engine oil when the message is displayed in the instrument cluster.

-  Adding engine oil  
Add oil within the next 125 miles/200 km; otherwise, this may cause engine damage. ◀
-  Do not add too much engine oil  
When too much engine oil is added, immediately have the vehicle checked, otherwise, this may cause engine damage. ◀
-  Protect children  
Keep oil, grease, etc., out of reach of children and observe the warnings on the containers to prevent health risks. ◀

## Engine oil types to add

### Hints

-  No oil additives  
Oil additives may lead to engine damage. ◀
-  Viscosity grades for engine oils  
When selecting an engine oil, ensure that the engine oil belongs to one of the viscosity grades SAE 0W-40, SAE 0W-30, SAE 5W-40, and SAE 5W-30 or malfunctions or engine damage may occur. ◀

The engine oil quality is critical for the life of the engine.

### Approved engine oil types

You can add engine oils with the following specifications:

Gasoline engine

BMW Longlife-01.

BMW Longlife-01 FE.

Additional information about the approved types of engine oils can be obtained from the service center.

### Alternative engine oil types

If the approved engine oils are not available, up to 1 US quart/liter of an engine oil with the following specification can be added:

Gasoline engine

API SM or superior grade specification.

### Engine oil change: تلفن شبانه روزی: ۰۲۱-۸۸۸۶۲۰۸۵

The vehicle manufacturer recommends that you let the service center change the motor oil.

FarmaSOS.com

# Coolant

## Vehicle features and options

This chapter describes all standard, country-specific and optional features offered with the series. It also describes features that are not necessarily available in your car, e. g., due to the selected options or country versions. This also applies to safety-related functions and systems.

## Hints

 Danger of burns from hot engine  
Do not open the cooling system while the engine is hot; otherwise, escaping coolant may cause burns. ◀

 Suitable additives  
Only use suitable additives; otherwise, engine damage may occur. The additives are harmful to your health. ◀

Coolant consists of water and additives.

Not all commercially available additives are suitable for the vehicle. Information about the suitable additives are available from the service center.

## Coolant level



### General information

Depending on the engine installation, the coolant reservoir is located on the right side or the left side of the engine compartment.

### Checking

1. Let the engine cool.
2. The coolant level is correct if it lies between the minimum and maximum marks.

The marks are on the side of the coolant reservoir.

| Symbol  | Meaning |
|---|---------|
|  | Maximum |
|  | Minimum |

### Adding

1. Let the engine cool.
2. Turn the lid of the coolant reservoir slightly counterclockwise to allow any excess pressure to dissipate, then open it.

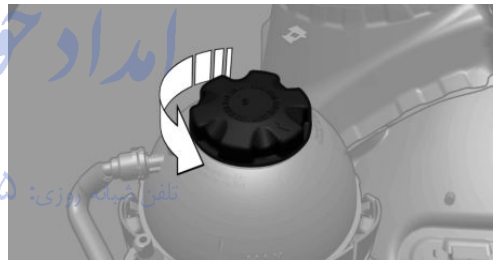

3. If the coolant is low, slowly add coolant up to the specified level; do not overfill.
4. Turn the lid until there is an audible click. The arrows on the coolant reservoir and the lid must point towards one another.
5. Have the cause of the coolant loss eliminated as soon as possible.

### Disposal



Comply with the relevant environmental protection regulations when disposing of coolant and coolant additives.

# Maintenance

## Vehicle features and options

This chapter describes all standard, country-specific and optional features offered with the series. It also describes features that are not necessarily available in your car, e. g., due to the selected options or country versions. This also applies to safety-related functions and systems.

## BMW maintenance system

The maintenance system indicates required maintenance measures, and thereby provides support in maintaining road safety and the operational reliability of the vehicle.

## Condition Based Service CBS

Sensors and special algorithms take into account the driving conditions of your vehicle. Based on this, Condition Based Service recognizes the maintenance requirements.

The system makes it possible to adapt the amount of maintenance corresponding to your user profile.

Detailed information on service requirements, refer to page 82, can be displayed on the Control Display.

## For service data

Information on the required maintenance is continuously stored in the remote control. Your service center will read out this data and suggest the right array of service procedures for your vehicle.

Therefore, hand your service specialist the remote control with which the vehicle was driven most recently.

## Storage periods

Storage periods during which the vehicle battery was disconnected are not taken into account.

If this occurs, have a service center update the time-dependent maintenance procedures, such as checking brake fluid and, if needed, changing the engine oil and the microfilter/activated-charcoal filter.

## Service and Warranty Information Booklet for US models and Warranty and Service Guide Booklet for Canadian models

Please consult your Service and Warranty Information Booklet for US models and Warranty and Service Guide Booklet for Canadian models for additional information on service requirements.

Maintenance and repair should be performed by your service center. Make sure to have regular maintenance procedures recorded in the vehicle's Service and Warranty Information Booklet for US models, and in the Warranty and Service Guide Booklet for Canadian models. These entries are proof of regular maintenance.

## Socket for OBD Onboard Diagnosis

### Note



Socket for Onboard Diagnosis

The socket for onboard diagnostics may only be used by the service center or a workshop that operates in accordance with the specifications of the vehicle manufacturer with



correspondingly trained personnel and other authorized persons. Otherwise, use may result in operating problems for the vehicle. ◀

## Position

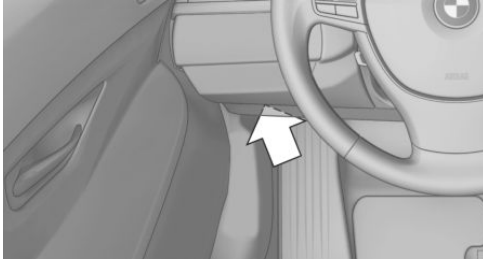

There is an OBD socket on the driver's side for checking the primary components in the vehicle's emissions.

## Emissions



- ▷ The warning lamp lights up:  
Emissions are deteriorating. Have the vehicle checked as soon as possible.

- ▷ The warning lamp flashes under certain circumstances:

This indicates that there is excessive misfiring in the engine.

Reduce the vehicle speed and have the system checked immediately; otherwise, serious engine misfiring within a brief period can seriously damage emission control components, in particular the catalytic converter.

امداد خودرو فارما

تلفن شبانه روزی: ۰۲۱-۸۸۷۲۰۸۵

FarmaSOS.com

# Replacing components

## Vehicle features and options

This chapter describes all standard, country-specific and optional features offered with the series. It also describes features that are not necessarily available in your car, e. g., due to the selected options or country versions. This also applies to safety-related functions and systems.

## Onboard vehicle tool kit

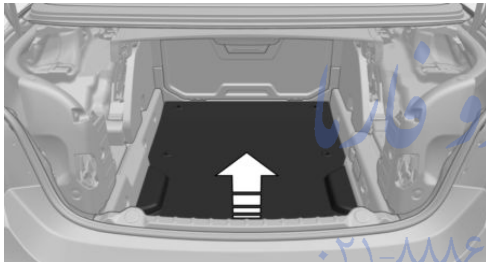

The onboard vehicle tool kit is located under the cargo floor panel.

3. Squeeze the retainer spring, arrow 1, and fold up the wiper blade, arrow 2.

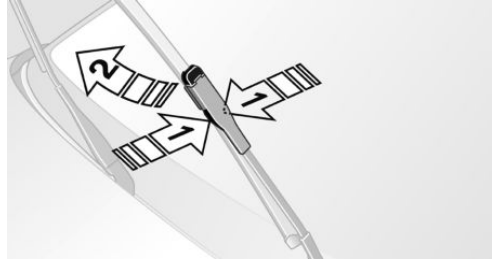

4. Remove the wiper blade forward from the catch.
5. Insert the new wiper blade in reverse order of removal until it locks in place.
6. Fold down the wipers.



Folding down wipers before opening the hood

Before opening the hood, ensure that the wiper arms with the wiper blades are against the windshield to prevent damage. ◀

## Wiper blade replacement

### Note



Do not fold down the wipers without wiper blades

Do not fold down the wipers if wiper blades have not been installed; this may damage the windshield. ◀

## Replacing the wiper blades

1. To change the wiper blades, fold up, refer to page 71, the wiper arms.
2. Fold up and hold the wiper arm firmly.

## Lamp and bulb replacement

### Hints

### Lights and bulbs

Lights and bulbs make an essential contribution to vehicle safety.

The manufacturer of the vehicle recommends that you entrust corresponding procedures to the service center if you are unfamiliar those or if they have not been described here.

You can obtain a selection of replacement bulbs at the service center.

**Danger of burns**

Only change bulbs when they are cool; otherwise, there is a danger of getting burned. ◀

**Working on the lighting system**

When working on the lighting system, you should always reel off the lights affected to prevent short circuits.

To avoid possible injury or equipment damage when replacing bulbs, observe any instructions provided by the bulb manufacturer. ◀

**Do not perform work/bulb replacement on xenon headlights**

Have any work on the xenon lighting system, including bulb replacement, performed only by a service center. Due to the high voltage present in the system, there is a danger of fatal injuries if work is carried out improperly. ◀

**Do not touch the bulbs**

Do not touch the glass of new bulbs with your bare hands, as even minute amounts of contamination will burn into the bulb's surface and reduce its service life.

Use a clean tissue, cloth or something similar, or hold the bulb by its base. ◀

**Light-emitting diodes (LEDs)**

Some items of equipment use light-emitting diodes installed behind a cover as a light source.

These light-emitting diodes, which are related to conventional lasers, are officially designated as Class 1 light-emitting diodes.

**Do not remove the covers**

Do not remove the covers, and never stare into the unfiltered light for several hours; otherwise, irritation of the retina could result. ◀

**Headlight glass**

Condensation can form on the inside of the external lights in cool or humid weather. When driving with the light switched on, the condensation evaporates after a short time. The headlight glass does not need to be changed.

If the headlights do not dim despite driving with the light switched on, increasing humidity forms, e. g. water droplets in the light, have the service center check this.

**Headlight setting**

The headlight adjustments can be affected by changing lights and bulbs. Have the headlights' settings checked and corrected by service after a replacement.

**Front lights, bulb replacement****Xenon headlights****Xenon headlights**

Because of the long life of these bulbs, the likelihood of failure is very low. Switching the lights on and off frequently shortens their life.

If a bulb fails, reel on the front fog lights and continue the trip with great care. Comply with local regulations.

**Do not perform work/bulb replacement on xenon headlights**

Have any work on the xenon lighting system, including bulb replacement, performed only by a service center. Due to the high voltage present in the system, there is a danger of fatal injuries if work is carried out improperly. ◀

For checking and adjusting headlamp aim, please contact your BMW center.

## Headlights

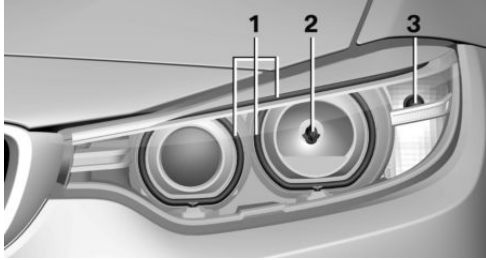

- 1 Parking lights / daytime running lights
- 2 Low beams/high beams/headlight flasher
- 3 Turn signal

Low beams and high beams are designed with xenon technology.

The parking lights and daylight running lights are made using LED technology.

Contact your service center in the event of a malfunction.

### Turn signal

Follow general instructions, refer to page 206.

21-watt bulb, PY21W

1. In the wheel house, loosen the two brackets and remove the cover.

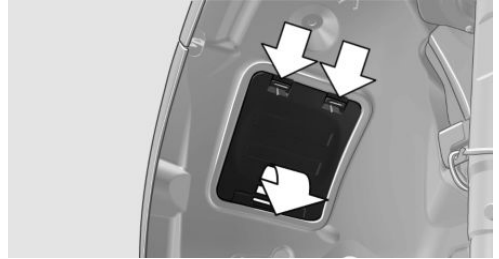

2. If necessary, pull the inside trim of the wheel house slightly inward. Turn the bulb socket counterclockwise and remove.

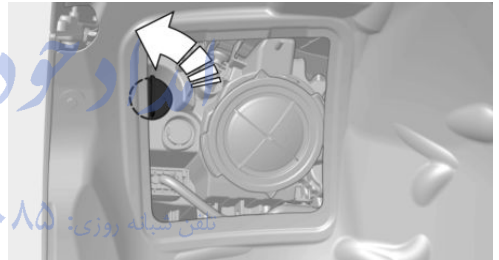

3. Press the bulb gently into the socket, turn counterclockwise and remove.
4. Install the new bulb and bulb holder in reverse order of removal.
5. Attach the cover to the wheel house.

## LED headlights

### Light-emitting diodes (LEDs)

With LED headlights, all front lights and side indicators are designed with LED technology.

If an LED fails, reel on the front fog lights and continue the trip with great care. Comply with local regulations.

Contact your service center in the event of a malfunction.

## Headlights

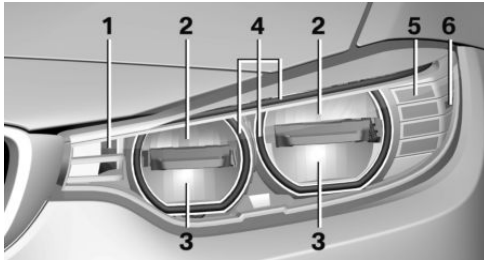

- 1 Cornering light
- 2 Low beams/headlight flasher
- 3 High beams/headlight flasher
- 4 Parking lights / daytime running lights
- 5 Turn signal
- 6 Side marker lights

Contact your service center in the event of a malfunction.

## Front fog lights

Follow general instructions, refer to page 206.

35-watt bulb, H8.

1. Use the handle of the screwdriver from the onboard vehicle tool kit to remove the three wheel house panel screws, arrow 1. Carefully pull back the wheel house panel, arrow 2.

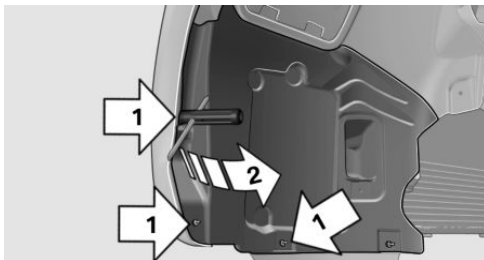

2. Pull off the bulb connector, arrow 1. Turn the bulb, arrow 2.  
Left side of vehicle: turn clockwise.  
Right side of vehicle: turn counterclockwise.

Remove the bulb.

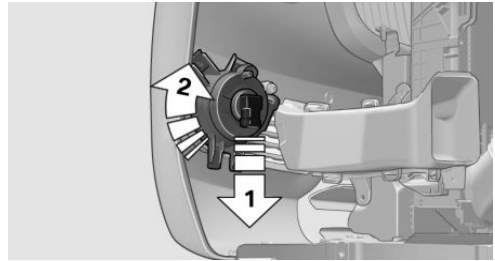

3. Insert the new bulb, connect the connector and screw on the wheel house panel.

## Turn signal in exterior mirror

Follow general instructions, refer to page 206.

The turn signals in the exterior mirrors feature LED technology. Contact your service center in the event of a malfunction.

## Tail lights, bulb replacement

### At a glance

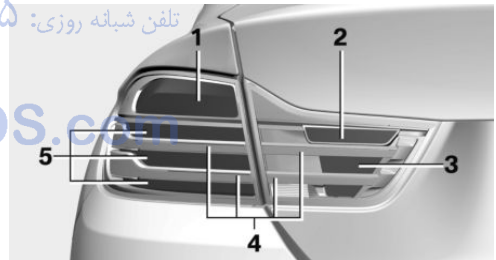

- 1 Turn signal
- 2 Reversing lamp
- 3 Inside brake lamp
- 4 Tail lights
- 5 Outside brake lamp

## Bulb replacement, exterior tail lights

### General information

Follow general instructions, refer to page 206.

Turn signal: 21-watt bulb, P21WLL.

Outer brake lamp: 21-watt bulb, H21WLL.

The tail lights feature LED technology. Contact your service center in the event of a malfunction.

-  Use caution when replacing the bulb
- Use caution and proceed one step at a time when replacing the bulbs to prevent damage to the tail lights or the vehicle. ◀

### Removing the exterior tail lamp

1. Open trunk lid.
2. Use a screwdriver out of the onboard vehicle tool kit to depress the catch fittings, arrows, and take off the cover.

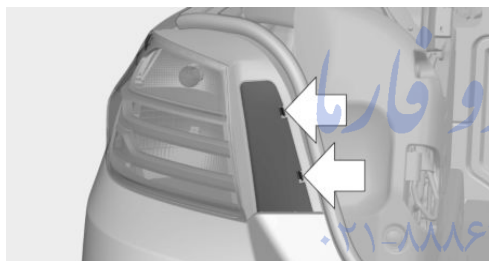

3. Loosen the two nuts with the screwdriver handle, arrows.

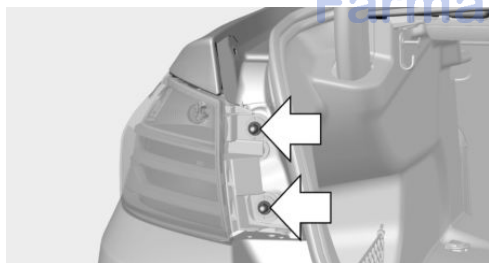

4. Grasp the inner edge of the tail lamp, arrow 1, and carefully pull it backward and out, arrow 2. Use your free hand to hold it in place in order to prevent the tail lamp from coming loose suddenly. Make sure

that the foam rubber sealing ring is on the centering pin.

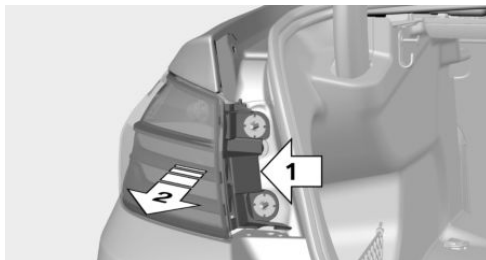

5. Release the catch at the top on the connector of the connecting line and remove the connector from the bulb holder.

### Replacing the bulbs

1. Loosen the three fasteners, arrows 1, on the bulb holder and remove the bulb holder from the tail lamp, arrow 2.

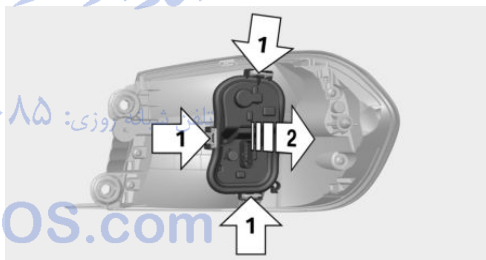

2. Press the defective bulb gently into the socket, turn counterclockwise and remove.
3. Proceed in the reverse order to insert the new bulb and attach the bulb holder. Make sure that the bulb holder engages in all fasteners.

### Installing the tail lamp

1. Connect the connecting line to the tail lamp and secure the bulb holder in the clip.
2. Make sure that the foam rubber sealing ring is on the centering pin, arrow 2, and is not damaged.
3. Position and firmly press the outer part of the tail lamp onto the rubber mount, ar-

row 1 and the inner part onto the centering component, arrow 2. Make sure that the tail lamp engages in the rubber mount.

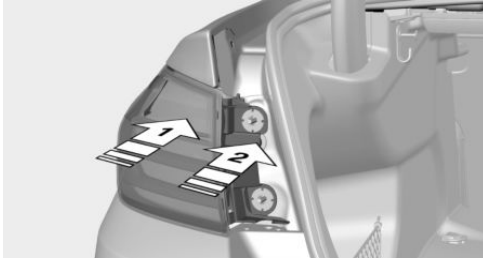

4. Screw the tail lamp on with the two nuts.
5. Mount the cover.

### Lights in the trunk lid

#### General information

Follow general instructions, refer to page 206.

Reversing lights: 16-watt bulb, PW16W.

Inner brake lights: 21-watt bulb, H21W

#### Accessing the lights

1. Use the screwdriver from the onboard vehicle tool kit to loosen and completely remove the two screws on the cover, arrow.

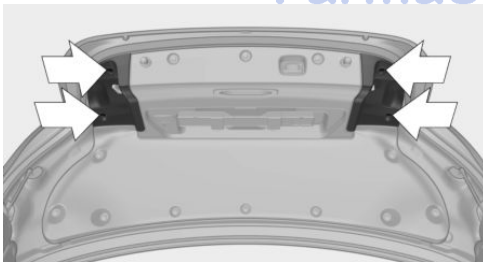

2. Remove the released cover.

### Replacing the reversing lamp and inner brake lamp

1. Loosen the bottom holder, arrow 1.

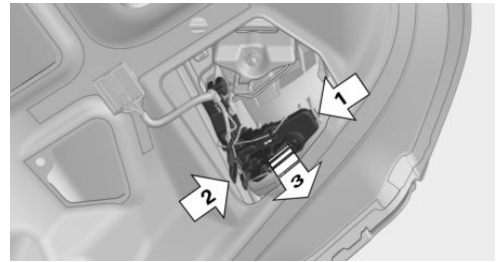

2. Loosen the top holder, arrow 2. To do so, press in the middle latch and then press out both outside latches. Remove the lamp holder, arrow 3.
3. Unscrew the defective bulb of the reversing or brake lamp from its socket counter-clockwise.
4. Insert the new bulb.

#### Installing the bulb holder

1. Insert the two contacts, arrow 1, into the connections, arrow 2.

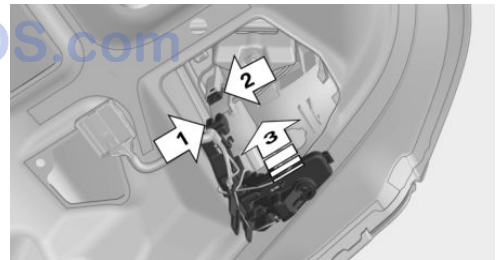

2. Press on the bulb holder, arrow 3. Make sure that the two exterior holders latch into place.
3. Reattach the two covers to the trunk lid.

### Rear lamp, license plate lamp and central brake lamp

Follow general instructions, refer to page 206.

These lights are made using LED technology. Contact your service center in the event of a malfunction.

## Changing wheels

### Hints

When using run-flat tires or sealants, a tire does not need to be changed immediately in the event of pressure loss due to a flat tire.

Which is why no spare tire is available.

The tools for changing wheels are available as accessories from your service center.

### Jacking points for the vehicle jack

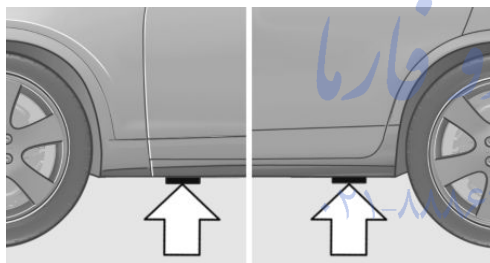

The jacking points for the vehicle jack are located at the positions shown.

## Vehicle battery

### Maintenance

The battery is maintenance-free.

The added amount of acid is sufficient for the service life of the battery.

Further information about the battery can be obtained from your service center.

## Battery replacement



Use approved vehicle batteries only

Only use vehicle batteries that have been approved for your vehicle by the manufacturer; otherwise, the vehicle could be damaged and systems or functions may not be fully available. ◀

After a battery replacement, have the battery registered on the vehicle by your service center to ensure that all comfort features are fully available and that any Check Control messages of these comfort features are no longer displayed.

## Charging the battery

### Note



Do not connect charging devices to the 12 volt socket in the vehicle

Do not connect battery chargers to the factory-installed 12 volt sockets in the vehicle as this may damage the vehicle battery due to an increased power consumption. ◀

## General information

Make sure that the battery is always sufficiently charged to guarantee that the battery remains usable for its full service life.

The battery may need to be charged in the following cases:

- ▷ When making frequent short-distance drives.
- ▷ If the vehicle is not used for prolonged periods, longer than a month.

## Starting aid terminals

In the vehicle, only charge the battery via the starting aid terminals, refer to page 217, in the engine compartment with the engine off.



## Power failure

After a temporary power loss, some equipment needs to be newly initialized or individual settings updated, e.g.:

- ▷ Seat and mirror memory: store the positions again.
- ▷ Time: update.
- ▷ Date: update.

## Disposing of old batteries



Have old batteries disposed of by your service center or bring them to a recycling center.

Maintain the battery in an upright position for transport and storage. Secure the battery so that it does not tip over during transport.

## Fuses

### Hints



Replacing fuses

Never attempt to repair a blown fuse and do not replace a defective fuse with a substitute of another color or amperage rating; this could lead to a circuit overload, ultimately resulting in a fire in the vehicle. ◀

Plastic tweezers and information on the fuse types and locations are stored in the fuse box in the cargo area.

## In the engine compartment

1. Use the onboard vehicle tool kit to loosen the three cover screws, arrow 1.

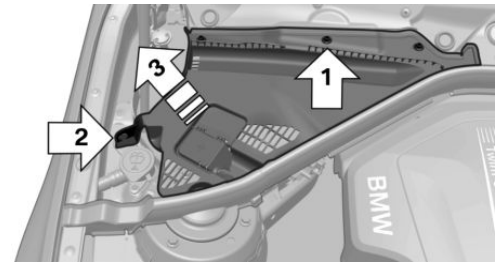

2. Pull up the holder, arrow 2.
3. Remove the cover from one side, arrow 3.
4. Press the four fasteners and remove the cover.

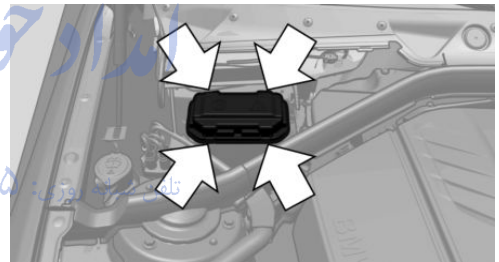

## Attaching the covers

1. When attaching the cover, make sure that all four fasteners are engaged.
2. Attach the cover under the rubber lip and then thread it between the bars.

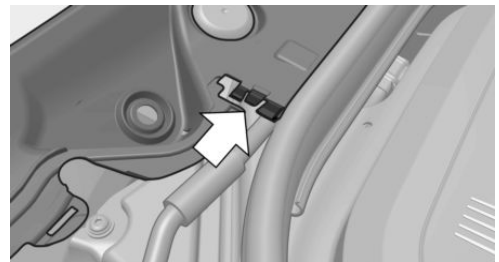

3. Press down on the holder and tighten the three screws.

## In the cargo area

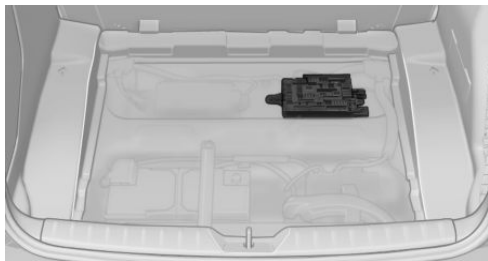

Fold up the cargo floor panel.

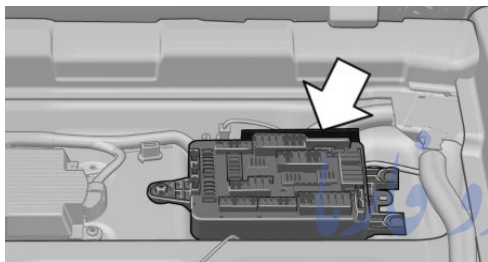

Information on the fuse types and locations is found on a separate sheet.

تلفن شبانه روزی: ۰۲۱-۸۸۸۶۲۰۸۵

FarmaSOS.com

# Breakdown assistance

## Vehicle features and options

This chapter describes all standard, country-specific and optional features offered with the series. It also describes features that are not necessarily available in your car, e. g., due to the selected options or country versions. This also applies to safety-related functions and systems.

## Hazard warning flashers

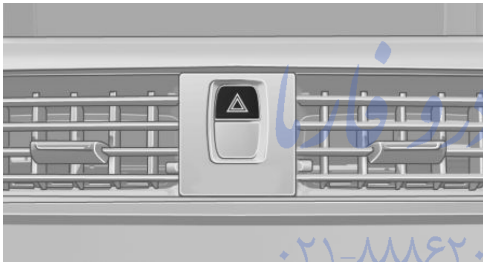

The button is located in the center console.

## Intelligent Emergency Request

### The concept

In case of an emergency, an Emergency Request can be made through this system.

### General information

Only press the SOS button in an emergency.

### Hints

-  Emergency Request not guaranteed
- For technical reasons, the Emergency Request cannot be guaranteed under unfavorable conditions. ◀

## At a glance



SOS button in the roofliner

## Requirements

- ▶ The SIM card integrated in the vehicle has been activated.
- ▶ The radio-ready state is switched on.
- ▶ The Assist system is functional.

## Initiating an Emergency Request

1. Press the cover briefly to open it.
  2. Press the SOS button until the LED at the button lights up green.
    - ▶ The LED lights up green: an Emergency Request was initiated.
- If a cancel prompt appears on the display, the Emergency Request can be aborted.
- If the situation allows, wait in your vehicle until the voice connection has been established.
- ▶ The LED flashes green when a connection to the BMW Response Center has been established.

When the emergency request is received at the BMW Response Center, the BMW Response Center contacts you and takes further steps to help you.

Even if you are unable to respond, the BMW Response Center can take further

steps to help you under certain circumstances.

For this, data are transmitted to the BMW Response Center which serve to determine the necessary rescue measures. E. g. the current position of the vehicle, if it can be established.

- ▷ If the LED is flashing green, but the BMW Response Center can no longer be heard via the speaker, you can nevertheless still be heard at the BMW Response Center.

### Initiating an Emergency Request automatically

Under certain conditions, an Emergency Request is automatically initiated immediately after a severe accident. Automatic Collision Notification is not affected by pressing the SOS button.

### Warning triangle

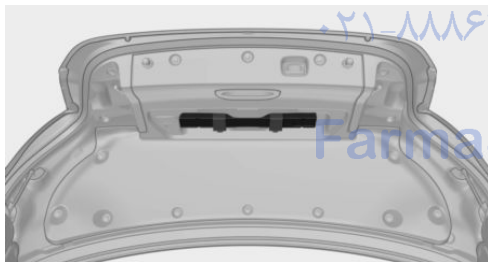

The warning triangle is located on the inside of the trunk lid.

To remove, loosen the bracket.

### First aid kit

#### Note

Some of the articles have a limited service life.

Check the expiration dates of the contents regularly and replace any expired items promptly.

### Storage

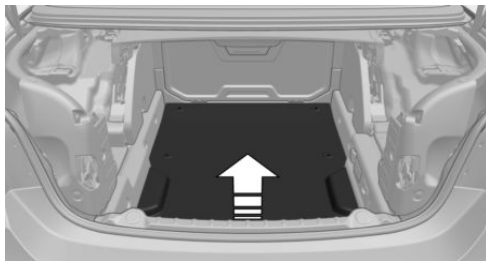

The first aid kit is located in a compartment under the cargo floor panel.

### Roadside Assistance

#### Service availability

Roadside Assistance can be reached around the clock in many countries. You can obtain assistance there in the event of a vehicle breakdown.

#### Roadside Assistance

The Roadside Assistance phone number can be viewed on the iDrive or a connection to Roadside Assistance can be established directly.

For additional information, see user's manual for Navigation, Entertainment and Communication.

### Jump-starting

#### Hints

If the battery is discharged, an engine can be started using the battery of another vehicle and two jumper cables. Only use jumper cables with fully insulated clamp handles.

To prevent personal injury or damage to both vehicles, adhere strictly to the following procedure.



Do not touch live parts

To avoid the risk of potentially fatal injury, always avoid all contact with electrical components while the engine is running. ◀

## Preparation

1. Check whether the battery of the other vehicle has a voltage of 12 volts. This information can be found on the battery.
2. Switch off the engine of the assisting vehicle.
3. Switch off any electronic systems/power consumers in both vehicles.



Bodywork contact between vehicles

Make sure that there is no contact between the bodywork of the two vehicles; otherwise, there is a danger of short circuits. ◀

## Starting aid terminals



Connecting order

Connect the jumper cables in the correct order to prevent risk of injury from arcing. ◀

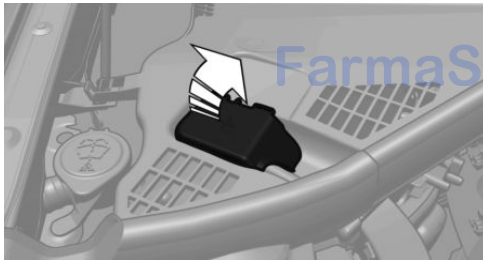

The so-called starting aid terminal in the engine compartment acts as the battery's positive terminal.

Open the cover of the starting aid terminal.

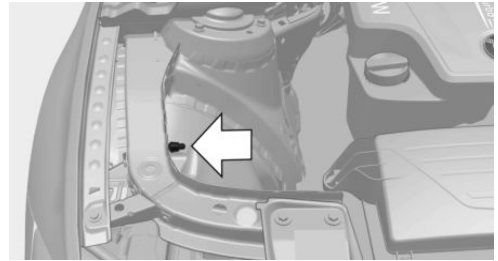

The body ground or a special nut acts as the battery negative terminal.

## Connecting the cables

1. Open the cover of the BMW starting aid terminal.
2. Attach one terminal clamp of the positive jumper cable to the positive terminal of the battery, or to the corresponding starting aid terminal of the vehicle providing assistance.
3. Attach the terminal clamp on the other end of the cable to the positive terminal of the battery, or to the corresponding starting aid terminal of the vehicle to be started.
4. Attach one terminal clamp of the negative jumper cable to the negative terminal of the battery, or to the corresponding engine or body ground of assisting vehicle.
5. Attach the second terminal clamp to the negative terminal of the battery, or to the corresponding engine or body ground of the vehicle to be started.

## Starting the engine

Never use spray fluids to start the engine.

1. Start the engine of the assisting vehicle and let it run for several minutes at an increased idle speed.
2. Start the engine of the vehicle that is to be started in the usual way.

If the first starting attempt is not successful, wait a few minutes before making an-

other attempt in order to allow the discharged battery to recharge.

3. Let both engines run for several minutes.
4. Disconnect the jumper cables in the reverse order.

Check the battery and recharge if needed.

## Tow-starting and towing

### Note

 Tow-starting and towing  
For towing the vehicle turn, switch off the Intelligent Safety systems; otherwise malfunctions of the individual braking systems might lead to accidents. ◀

### Steptronic transmission: transporting your vehicle

### Note

Your vehicle is not permitted to be towed. Therefore, contact a service center in the event of a breakdown.

 Do not have the vehicle towed  
Have your vehicle transported on a loading platform only; otherwise, damage may occur. ◀

### Tow truck

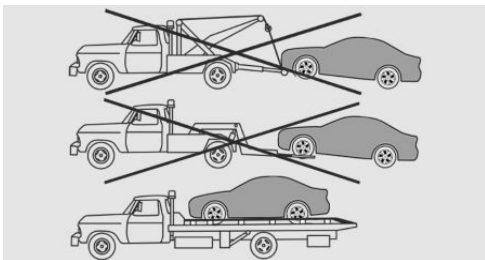

The vehicle should only be transported on a loading platform.

 Do not lift the vehicle  
Do not lift the vehicle by the tow fitting or body and chassis parts; otherwise, damage may result. ◀

Use tow fitting located in the front only for positioning the vehicle.

## Towing other vehicles

### Hints

 Light towing vehicle  
The towing vehicle must not be lighter than the vehicle being towed; otherwise, it will not be possible to control the vehicle's response. ◀

 Attaching the tow bar/tow rope correctly  
Attach the tow bar or tow rope to the tow fitting; connecting it to other vehicle parts may cause damage. ◀

- ▷ Switch on the hazard warning system, depending on local regulations.
- ▷ If the electrical system has failed, clearly identify the vehicle being towed by placing a sign or a warning triangle in the rear window.

### Tow bar

The tow fittings used should be on the same side on both vehicles.

Should it prove impossible to avoid mounting the tow bar at an offset angle, please observe the following:

- ▷ Maneuvering capability is limited going around corners.
- ▷ The tow bar will generate lateral forces if it is secured with an offset.

### Tow rope

When starting to tow the vehicle, make sure that the tow rope is taut.

To avoid jerking and the associated stresses on the vehicle components when towing, always use nylon ropes or nylon straps.

### Tow fitting

The screw-in tow fitting should always be carried in the vehicle.

The tow fitting can be screwed in at the front or rear of the BMW.

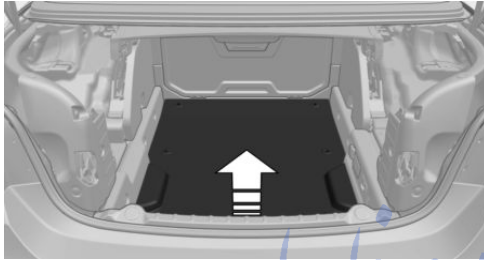

The tow fitting is located in a compartment under the cargo floor panel.



Tow fitting, information on use

- ▶ Use only the tow fitting provided with the vehicle and screw it all the way in.
- ▶ Use the tow fitting for towing on paved roads only.
- ▶ Avoid lateral loading of the tow fitting, e.g., do not lift the vehicle by the tow fitting.

Otherwise, damage to the tow fitting and the vehicle can occur. ◀

### Screw thread for tow fitting

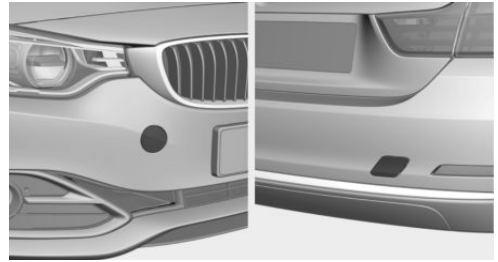

Press on the mark on the edge of the cover to push it out.

### Tow-starting

#### Steptronic transmission

Do not tow-start the vehicle.

Tow-starting the engine is not possible due to the Steptronic transmission.

Have the cause of the starting problems fixed.

# Care

## Vehicle features and options

This chapter describes all standard, country-specific and optional features offered with the series. It also describes features that are not necessarily available in your car, e. g., due to the selected options or country versions. This also applies to safety-related functions and systems.

## Car washes

### General information

Regularly remove foreign objects such as leaves in the area below the windshield when the hood is raised.

Wash your vehicle frequently, particularly in winter. Intense soiling and road salt can damage the vehicle.

### Hints

 Steam jets or high-pressure washers  
When using steam jets or high-pressure washers, hold them a sufficient distance away and use a maximum temperature of 140 °F/60 °C.

Holding them too close or using excessively high pressures or temperatures can cause damage or preliminary damage that may then lead to long-term damage.

Follow the user's manual for the high-pressure washer. ◀

 Cleaning sensors/cameras/hardtop with high-pressure washers

When using high-pressure washers, do not spray the seals of the lowerable hardtop, sensors and cameras external to the vehicle, e.g., Park Distance Control, for extended periods of

time and only from a distance of at least 12 in/30 cm. ◀

## Automatic car washes

### Hints

 Do not use high pressure washing systems

With washing systems operating at high pressures and nozzle positions close to the windows, drops of water can penetrate. ◀

- ▶ Give preference to cloth car washes or those that use soft brushes in order to avoid paint damage.
- ▶ Make sure that the wheels and tires are not damaged by the transport mechanisms.
- ▶ Fold in the exterior mirrors; otherwise, they may be damaged, depending on the width of the vehicle.
- ▶ Deactivate the rain sensor, refer to page 70, to avoid unintentional wiper activation.
- ▶ In some cases, an unintentional alarm can be triggered by the interior motion sensor of the alarm system. Follow the instructions on avoiding an unintentional alarm, refer to page 44.

 Guide rails in car washes  
Avoid car washes with guide rails higher than 4 in/10 cm; otherwise, the vehicle body could be damaged. ◀

## Before driving into a car wash

In order to ensure that the vehicle can roll in a car wash, take the following steps:

Steptronic transmission:

1. Drive into the car wash.
2. Engage selector lever position N.



### 3. Switch the engine off.

In this way, the ignition remains switched on, and a Check-Control message is displayed.



Do not turn off the ignition in the car wash

Do not turn off the ignition in the car wash; otherwise, selector lever position P is engaged and damages can result. ◀

The vehicle cannot be locked from the outside when in selector lever position N. A signal sounds when an attempt is made to lock the vehicle.

To start the engine with Steptronic transmission:

1. Depress the brake pedal.
2. Press the Start/Stop button.

Pressing the Start/Stop button without stepping on the brake turns the ignition off.

### Selector lever position

Selector lever position P is engaged automatically:

- ▶ When the ignition is switched off.
- ▶ After approx. 15 minutes.

### Headlights

- ▶ Do not rub dry and do not use abrasive or acidic cleansers.
- ▶ Soak areas that have been dirtied e. g., from insects, with shampoo and wash off with water.
- ▶ Thaw ice with de-icing spray; do not use an ice scraper.

### Lowerable hardtop

When the wet hardtop is opened, water droplets can run into the cargo area. Remove any objects in the cargo area beforehand to prevent water spotting or soiling.

### After washing the vehicle

After washing the vehicle, apply the brakes briefly to dry them; otherwise, braking action can be reduced and corrosion of the brake discs can occur.

Completely remove all residues on the windows, to minimize loss of visibility due to smearing and to reduce wiper noises and wiper blade wear.

## Vehicle care

### Car care products

BMW recommends using care and cleaning products from BMW, since these have been tested and approved.



Car care and cleaning products

Follow the instructions on the container.

When cleaning the interior, open the doors or windows.

Only use products intended for cleaning vehicles. تلفن شبانه روز: ۰۲۱-۸۸۶۲۰۸۵

Cleansers can contain substances that are dangerous and harmful to your health. ◀

### Vehicle paint

Regular care contributes to driving safety and value retention. Environmental influences in areas with elevated air pollution or natural contaminants, such as tree resin or pollen can affect the vehicle's paintwork. Tailor the frequency and extent of your car care to these influences.

Aggressive substances such as spilled fuel, oil, grease or bird droppings, must be removed immediately to prevent the finish from being altered or discolored.

### Leather care

Remove dust from the leather often, using a cloth or vacuum cleaner.

Otherwise, particles of dust and road grime chafe in pores and folds, and lead to increased wear and premature degradation of the leather surface.

To guard against discoloration, such as from clothing, provide leather care roughly every two months.

Clean light-colored leather more frequently because soiling on such surfaces is substantially more visible.

Use leather care products; otherwise, dirt and grease will gradually break down the protective layer of the leather surface.

Suitable care products are available from the service center.

### Upholstery material care

Vacuum regularly with a vacuum cleaner.

If upholstery is very dirty, e.g., with beverage stains, use a soft sponge or microfiber cloth with a suitable interior cleaner.

Clean the upholstery down to the seams using large sweeping motions. Avoid rubbing the material vigorously.



Damage from Velcro® fasteners

Open Velcro® fasteners on pants or other articles of clothing can damage the seat covers. Ensure that any Velcro® fasteners are closed. ◀

### Caring for special components

#### Light-alloy wheels

When cleaning the vehicle, use only neutral wheel cleaners having a pH value from 5 to 9. Do not use abrasive cleaning agents or steam jets above 140 °F/60 °C. Follow the manufacturer's instructions.

Aggressive, acidic or alkaline cleaning agents can destroy the protective layer of adjacent components, such as the brake disk.

### Chrome surfaces

Carefully clean components such as the radiator grille or door handles with an ample supply of water, possibly with shampoo added, particularly when they have been exposed to road salt.

### Rubber components

Aside from water, treat only with rubber cleansers.

When cleaning rubber seals, do not use any silicon-containing car care products in order to avoid damage or noises.

### Fine wood parts

Clean fine wood facing and fine wood components only with a moist rag. Then dry with a soft cloth.

### Plastic components

These include:

- ▷ Imitation leather surfaces.
- ▷ Roofliner. تلفن شیشه
- ▷ Lamp lenses.
- ▷ Instrument cluster cover.
- ▷ Matt black spray-coated components.
- ▷ Painted parts in the interior.

Clean with a microfiber cloth.

Dampen cloth lightly with water.

Do not soak the roofliner.



No cleansers that contain alcohol or solvents

Do not use cleansers that contain alcohol or solvents, such as lacquer thinners, heavy-duty grease removers, fuel, or such; this could lead to surface damage. ◀

### Safety belts

Dirty belt straps impede the reeling action and thus have a negative impact on safety.

**Chemical cleaning**

Do not clean chemically; this can destroy the webbing. ◀

Use only a mild soapy solution, with the safety belts clipped into their buckles.

Do not allow the reels to retract the safety belts until they are dry.

**Carpets and floor mats**

No objects in the area around the pedals

Keep floor mats, carpets, and any other objects out of the pedal area; otherwise, the function of the pedals could be impeded while driving and create the risk of an accident.

Do not place additional floor mats over existing mats or other objects.

Only use floor mats that have been approved for the vehicle and can be properly attached to floor.

Ensure that the floor mats are securely fastened again after they were removed for cleaning, e.g. ◀

Floor mats can be removed from the car's interior for cleaning.

If the floor carpets are very dirty, clean with a microfiber cloth and water or a textile cleaner. To prevent matting of the carpet, rub back and forth in the direction of travel only.

**Sensors/cameras**

To clean sensors and cameras, use a cloth moistened with a small amount of glass cleaner.

**Displays/monitors**

Cleaning displays and screens

Do not use any chemical or household cleaning agents; otherwise, surfaces can be affected. ◀



Keeping out moisture

Keep all fluids and moisture away from the unit; otherwise, electrical components can be damaged. ◀



Avoid pressure

Avoid pressing too hard when cleaning and do not use abrasive materials; otherwise, damage can result. ◀

Clean with a clean, antistatic microfiber cloth.

**Long-term**

When the vehicle is shut down for longer than three months, special measures must be taken. Additional information is available from the service center.



# امداد خودرو فارما

تلفن شبانه روزی: ۰۲۱-۸۸۸۶۲۰۸۵

[FarmaSOS.com](http://FarmaSOS.com)

## Reference

This chapter contains the technical data and an index that will quickly take you to the information you need.

امداد خودرو فارما

تلفن شبانه روزی: ۰۲۱-۸۸۸۶۲۰۸۵

FarmaSOS.com

# Technical data

## Vehicle features and options

This chapter describes all standard, country-specific and optional features offered with the series. It also describes features that are not

necessarily available in your car, e. g., due to the selected options or country versions. This also applies to safety-related functions and systems.

## Note

The technical data and specifications in this Owner's Manual are used as guidance values. The vehicle-specific data can deviate from this, for example, due to the selected special equipment, country version or country-specific measurement method. Detailed values can be

found in the approval documents, on information signs on the vehicle or can be obtained from the service center.

The information in the vehicle documents always has priority.

## Dimensions

### Note

The dimensions can vary depending on the model version, equipment or country-specific measurement method.

roof racks or spoiler. The heights can deviate, for example, due to the selected special equipment, tires, load and chassis version.

The specified heights do not take into account attached parts, for example, a roof antenna,

### BMW 4 Series Convertible

|                               |           |                       |
|-------------------------------|-----------|-----------------------|
| Width with mirrors            | inches/mm | 79.4/2,017            |
| Width without mirrors         | inches/mm | 71.9/1,825            |
| Height                        | inches/mm | 54.5–55.1/1,384–1,399 |
| Length                        | inches/mm | 182.6/4,639           |
| Wheelbase                     | inches/mm | 110.6/2,810           |
| Smallest turning radius diam. | ft/m      | 37.1–38.7/11.3–11.8   |

## Weights

| 428i                          |              |                  |
|-------------------------------|--------------|------------------|
| Approved gross vehicle weight | lbs/kg       | 4,770/2,164      |
| Load                          | lbs/kg       | 680/308          |
| Approved front axle load      | lbs/kg       | 2,115/959        |
| Approved rear axle load       | lbs/kg       | 2,710/1,229      |
| Cargo area capacity           | cu ft/liters | 7.8–13.1/220–370 |

| 435i                          |              |                  |
|-------------------------------|--------------|------------------|
| Approved gross vehicle weight | lbs/kg       | 4,870/2,209      |
| Load                          | lbs/kg       | 680/308          |
| Approved front axle load      | lbs/kg       | 2,235/1,014      |
| Approved rear axle load       | lbs/kg       | 2,710/1,229      |
| Cargo area capacity           | cu ft/liters | 7.8–13.1/220–370 |

| 428i xDrive                   |              |                  |
|-------------------------------|--------------|------------------|
| Approved gross vehicle weight | lbs/kg       | 4,895/2,220      |
| Load                          | lbs/kg       | 680/308          |
| Approved front axle load      | lbs/kg       | 2,250/1,021      |
| Approved rear axle load       | lbs/kg       | 2,700/1,225      |
| Cargo area capacity           | cu ft/liters | 7.8–13.1/220–370 |

| 435i xDrive                   |              |                  |
|-------------------------------|--------------|------------------|
| Approved gross vehicle weight | lbs/kg       | 5,005/2,270      |
| Load                          | lbs/kg       | 680/308          |
| Approved front axle load      | lbs/kg       | 2,380/1,080      |
| Approved rear axle load       | lbs/kg       | 2,710/1,229      |
| Cargo area capacity           | cu ft/liters | 7.8–13.1/220–370 |

## Capacities

|                    | US gal/liters     | Notes   |
|--------------------|-------------------|---|
| Fuel tank, approx. | Gasoline: 15.8/60 | Fuel quality, refer to page <a href="#">186</a> |

امداد خودرو فارما

تلفن شبانه روزی: ۰۲۱-۸۸۸۶۲۰۸۵

FarmaSOS.com



امداد خودرو فارما

تلفن شبانه روزی: ۰۲۱-۸۸۸۶۲۰۸۵

**FarmaSOS.com**

# Everything from A to Z

## Index

### A

- ABS, Antilock Brake System **119**  
 ACC, Active Cruise Control with Stop & Go **124**  
 Acceleration Assistant, refer to Launch Control **74**  
 Activated-charcoal filter **150**  
 Active Blind Spot Detection **115**  
 Active Cruise Control with Stop & Go, ACC **124**  
 Adaptive brake lights, refer to Brake force display **117**  
 Adaptive Light Control **92**  
 Additives, oil **201**  
 Adjustments, seats/head restraints **52**  
 After washing vehicle **221**  
 Airbags **96**  
 Airbags, indicator/warning light **97**  
 Air circulation, refer to Recirculated-air mode **147, 149**  
 Air, dehumidifying, refer to Cooling function **146, 149**  
 Air distribution, manual **146, 150**  
 Air flow, air conditioner **146**  
 Air flow, automatic climate control **150**  
 Air pressure, tires **188**  
 Air vents, refer to Ventilation **151**  
 Alarm system **43**  
 Alarm, unintentional **44**  
 All around the center console **16**  
 All around the roofliner **17**  
 All around the steering wheel **14**  
 All-season tires, refer to Winter tires **196**  
 All-wheel-drive **120**  
 Alternating-code hand-held transmitter **154**  
 Alternative oil types **202**  
 Antifreeze, washer fluid **71**  
 Antilock Brake System, ABS **119**  
 Anti-slip control, refer to DSC **119**  
 Anti-theft protection, see through-loading system **161**  
 Approved axle load **227**  
 Approved engine oils **202**  
 Arrival time **86**  
 Ash tray **157**  
 Assistance, Roadside Assistance **216**  
 Assistance when driving off **123**  
 Assist system information, on Control Display **89**  
 Attentiveness assistant **117**  
 AUTO intensity **149**  
 Automatic car wash **220**  
 Automatic climate control **145**  
 Automatic climate control with enhanced features **148**  
 Automatic Cruise Control with Stop & Go **124**  
 Automatic Curb Monitor **58**  
 Automatic deactivation, front-seat passenger airbags **98**  
 Automatic headlight control **92**  
 Automatic locking **43**  
 Automatic recirculated-air control **149**  
 Automatic transmission, see Steptronic transmission **72**  
 AUTO program, automatic climate control **149**  
 AUTO program, climate control **146**  
 AUTO program, intensity **149**  
 Auto Start/Stop function **66**  
 Average fuel consumption **86**  
 Average speed **86**  
 Axle loads, weights **227**  
 Backrest curvature, refer to Lumbar support **53**  
 Backrest, width **53**  
 Band-aids, refer to First aid kit **216**  
 Bar for tow-starting/towing **218**  
 Battery replacement, vehicle battery **212**  
 Battery replacement, vehicle remote control **34**  
 Battery, vehicle **212**  
 Belts, safety belts **55**  
 Beverage holder, cupholder **165**  
 BMW Assist, see user's manual for Navigation, Entertainment and Communication  
 BMW maintenance system **204**  
 Bonus range, ECO PRO **176**  
 Bottle holder, refer to Cupholders **165**  
 Brake assistant **119**

### B

- Brake discs, break-in **168**  
 Brake force display **117**  
 Brake lights, adaptive **117**  
 Brake lights, brake force display **117**  
 Brake pads, break-in **168**  
 Braking, hints **169**  
 Breakdown assistance **215, 216**  
 Break-in **168**  
 Brightness of Control Display **89**  
 Bulb replacement **206**  
 Bulb replacement, front **207**  
 Bulb replacement, LED headlights **208**  
 Bulb replacement, rear **209**  
 Bulb replacement, xenon headlights **207**  
 Bulbs and lights **206**  
 Button, RES **127**  
 Button, Start/Stop **64**  
 Bypassing, refer to Jump-starting **216**
- C**
- California Proposition 65 Warning **7**  
 Camera, care **223**  
 Camera, rearview camera **135**  
 Camera, Side View **138**  
 Camera, Top View **139**  
 Can holder, refer to Cupholders **165**  
 Car battery **212**  
 Car care products **221**  
 Care, displays **223**  
 Care, vehicle **221**  
 Cargo **171**  
 Cargo area, enlarging **161**  
 Cargo area partition **48**  
 Cargo area, storage compartments **165**  
 Cargo, securing **172**  
 Cargo straps, securing cargo **172**  
 Car key, refer to Remote control **34**  
 Carpet, care **223**  
 Car wash **220**  
 Catalytic converter, refer to Hot exhaust system **168**  
 CBS Condition Based Service **204**  
 CD/Multimedia, see user's manual for Navigation, Entertainment and Communication  
 Center armrest **164**  
 Center console **16**  
 Central locking system **39**  
 Central screen, refer to Control Display **18**  
 Changes, technical, refer to Safety **7**  
 Changing parts **206**  
 Changing wheels **212**  
 Changing wheels/tires **195**  
 Chassis number, see vehicle identification number **9**  
 Check Control **77**  
 Checking the engine oil level electronically **200**  
 Checking the oil level electronically **200**  
 Children, seating position **61**  
 Children, transporting safely **61**  
 Child restraint fixing system **61**  
 Child restraint fixing system LATCH **63**  
 Child restraint fixing systems, mounting **61**  
 Child seat, mounting **61**  
 Child seats **61**  
 Chrome parts, care **222**  
 Cigarette lighter **157**  
 Cleaning displays **223**  
 Climate control **145, 148**  
 Clock **81**  
 Closing/opening via door lock **39**  
 Closing/opening with remote control **37**  
 Coasting **178**  
 Coasting with engine decoupled, coasting **178**  
 Coasting with idling engine **178**  
 Cockpit **14**  
 Combination reel, refer to Turn signals **68**  
 Combination reel, refer to Wiper system **69**  
 Comfort Access **41**  
 COMFORT program, Dynamic Driving Control **122**  
 Compartments in the doors **164**  
 Compass **155**  
 Computer **85**  
 Condensation on windows **150**  
 Condensation under the vehicle **170**  
 Condition Based Service CBS **204**  
 Configuring driving program **123**  
 Confirmation signal **43**  
 ConnectedDrive, see user's manual for Navigation, Entertainment and Communication  
 ConnectedDrive Services  
 Connecting electrical devices **157**  
 Continued driving with a flat tire **102, 105**  
 Control Display **18**  
 Control Display, settings **88**  
 Controller **18, 19**  
 Control systems, driving stability **119**

Convenient closing with the remote control **37**  
 Convenient opening with the remote control **37**  
 Convertible, Hardtop **46**  
 Convertible mode, automatic climate control **146, 149**  
 Convertible program, automatic climate control **146, 149**  
 Coolant **203**  
 Coolant level **203**  
 Coolant temperature **81**  
 Cooling function **146, 149**  
 Cooling, maximum **149**  
 Cooling system **203**  
 Corrosion on brake discs **170**  
 Cosmetic mirror **157**  
 Cruise control **130**  
 Cruise control, active with Stop & Go **124**  
 Cruising range **81**  
 Cupholders **165**  
 Current fuel consumption **82**

## D

Damage, tires **194**  
 Damping control, dynamic **121**  
 Data, technical **226**  
 Date **81**  
 Daytime running lights **92**  
 Defrosting, refer to defrosting the windows **146**  
 Defrosting, refer to Windows, defrosting **150**  
 Defrosting the windows **146**  
 Dehumidifying, air **146, 149**  
 Deleting personal data **24**  
 Deletion of personal data **24**  
 Destination distance **86**  
 Digital clock **81**  
 Digital compass **155**  
 Dimensions **226**  
 Dimmable exterior mirrors **59**

Dimmable interior rearview mirror **59**  
 Direction indicator, refer to Turn signals **68**  
 Display, electronic, instrument cluster **76**  
 Display in windshield **89**  
 Display lighting, refer to Instrument lighting **94**  
 Displays, cleaning **223**  
 Disposal, coolant **203**  
 Disposal, vehicle battery **213**  
 Distance control, refer to PDC **132**  
 Distance to destination **86**  
 Divided screen view, split screen **23**  
 Door lock **39**  
 Door lock, refer to Remote control **34**  
 Drive-off assistant **123**  
 Drive-off assistant, refer to DSC **119**  
 Driver assistance, refer to Intelligent Safety **105**  
 Driving Assistant, refer to Intelligent Safety **105**  
 Driving Dynamics Control **121**  
 Driving instructions, break-in **168**  
 Driving mode **121**  
 Driving notes, general **168**  
 Driving stability control systems **119**  
 Driving style analysis **179**  
 Driving tips **168**  
 DSC Dynamic Stability Control **119**  
 DTC Dynamic Traction Control **120**  
 Dynamic Damping Control **121**  
 Dynamic Stability Control DSC **119**

Dynamic Traction Control DTC **120**

## E

ECO PRO **175**  
 ECO PRO, bonus range **176**  
 ECO PRO display **175**  
 ECO PRO driving mode **175**  
 ECO PRO driving style analysis **179**  
 ECO PRO mode **175**  
 ECO PRO Tip - driving instruction **177**  
 EfficientDynamics **177**  
 Electronic displays, instrument cluster **76**  
 Electronic oil measurement **200**  
 Electronic Stability Program ESP, refer to DSC **119**  
 Emergency detection, remote control **35**  
 Emergency release, fuel filler flap **184**  
 Emergency Request **215**  
 Emergency service, refer to Roadside Assistance **216**  
 Emergency start function, engine start **35**  
 Emergency unlocking, transmission lock **74**  
 Emergency unlocking, trunk lid **41**  
 Energy Control **82**  
 Energy recovery **82**  
 Engine, automatic reel-off **66**  
 Engine, automatic Start/Stop function **66**  
 Engine compartment **198**  
 Engine compartment, working in **199**  
 Engine coolant **203**  
 Engine idling when driving, coasting **178**  
 Engine oil **200**

Engine oil, adding [201](#)  
 Engine oil additives [201](#)  
 Engine oil change [202](#)  
 Engine oil filler neck [201](#)  
 Engine oil temperature [80](#)  
 Engine oil types, alternative [202](#)  
 Engine oil types, approved [202](#)  
 Engine start during malfunction [35](#)  
 Engine start, jump-starting [216](#)  
 Engine start, refer to Starting the engine [65](#)  
 Engine stop [65](#)  
 Engine temperature [80](#)  
 Entering a car wash [220](#)  
 Equipment, interior [153](#)  
 Error displays, see Check Control [77](#)  
 ESP Electronic Stability Program, refer to DSC [119](#)  
 Exchanging wheels/tires [195](#)  
 Exhaust system [168](#)  
 Exterior mirror, automatic dimming feature [59](#)  
 Exterior mirrors [58](#)  
 External start [216](#)  
 External temperature display [81](#)  
 External temperature warning [81](#)  
 Eyes for securing cargo [172](#)

## F

Failure message, see Check Control [77](#)  
 False alarm, refer to Unintentional alarm [44](#)  
 Fan, refer to Air flow [146, 150](#)  
 Filler neck for engine oil [201](#)  
 Fine wood, care [222](#)  
 First aid kit [216](#)

Fitting for towing, see tow fitting [219](#)  
 Flat tire, changing wheels [212](#)  
 Flat Tire Monitor FTM [104](#)  
 Flat tire, Tire Pressure Monitor TPM [100](#)  
 Flat tire, warning lamp [101, 104](#)  
 Flooding [169](#)  
 Floor carpet, care [223](#)  
 Floor mats, care [223](#)  
 Fogged up windows [146](#)  
 Fold down the rear seat backrest, see Though-loading system [161](#)  
 Fold-out position, wiper [71](#)  
 Foot brake [169](#)  
 Front airbags [96](#)  
 Front-end collision warning with braking function [109](#)  
 Front-end collision warning with City Braking function [106](#)  
 Front fog lights [94](#)  
 Front fog lights, front, bulb replacement [209](#)  
 Front lights [207](#)  
 front-seat passenger airbags, automatic deactivation [98](#)  
 Front-seat passenger airbags, indicator lamp [98](#)  
 FTM Flat Tire Monitor [104](#)  
 Fuel [186](#)  
 Fuel consumption, current [82](#)  
 Fuel consumption, refer to Average fuel consumption [86](#)  
 Fuel filler flap [184](#)  
 Fuel gauge [80](#)  
 Fuel lid [184](#)  
 Fuel quality [186](#)  
 Fuel recommendation [186](#)  
 Fuel, tank capacity [228](#)  
 Fuse [213](#)

## G

Garage door opener, refer to Universal Integrated Remote Control [153](#)  
 Gasoline [186](#)  
 Gear change, Steptronic transmission [72](#)  
 Gear shift indicator [83](#)  
 General driving notes [168](#)  
 Glare shield [157](#)  
 Glove compartment [163](#)  
 Gross vehicle weight, approved [227](#)

## H

Handbrake, refer to parking brake [67](#)  
 Hand-held transmitter, alternating code [154](#)  
 Hardtop [46](#)  
 Hardtop, cargo area partition [48](#)  
 Hardtop, rollover protection system [99](#)  
 Hazard warning flashers [215](#)  
 Headlight control, automatic [92](#)  
 Headlight courtesy delay feature [91](#)  
 Headlight flasher [69](#)  
 Headlight glass [207](#)  
 Headlights [207](#)  
 Headlights, care [221](#)  
 Headlight washer system [69](#)  
 Head restraints [52](#)  
 Head restraints, front [56](#)  
 Head-up Display [89](#)  
 Head-up Display, care [223](#)  
 Heating, neck [54](#)  
 Heavy cargo, stowing [172](#)  
 Height, vehicle [226](#)  
 High-beam Assistant [93](#)  
 High beams [69](#)

High beams/low beams, refer to High-beam Assistant **93**  
 Hills **170**  
 Hill start assistant, refer to Drive-off assistant **123**  
 Hints **6**  
 Holder for beverages **165**  
 Hood **199**  
 Horn **14**  
 Hotel function, trunk lid **40**  
 Hot exhaust system **168**  
 HUD Head-up Display **89**  
 Hydroplaning **169**

## I

Ice warning, see External temperature warning **81**  
 Icy roads, see External temperature warning **81**  
 Identification marks, tires **192**  
 Identification number, see vehicle identification number **9**  
 iDrive **18**  
 Ignition key, refer to Remote control **34**  
 Ignition off **64**  
 Ignition on **64**  
 Indication of a flat tire **101, 104**  
 Indicator and alarm lamps, see Check Control **77**  
 Indicator lamp, see Check Control **77**  
 Individual air distribution **146, 150**  
 Individual settings, refer to Personal Profile **35**  
 Inflation pressure, tires **188**  
 Inflation pressure warning FTM, tires **104**  
 Info display, refer to Computer **85**  
 Initialize, Tire Pressure Monitor TPM **101**  
 Initializing, Flat Tire Monitor FTM **104**  
 Instrument cluster **76**  
 Instrument cluster, electronic displays **76**  
 Instrument lighting **94**  
 Integrated key **34**  
 Integrated Owner's Manual in the vehicle **29**  
 Intelligent Emergency Request **215**  
 Intelligent Safety **105**  
 Intensity, AUTO program **149**  
 Interior equipment **153**  
 Interior lights **94**  
 Interior lights via remote control **38**  
 Interior motion sensor **44**  
 Interior rearview mirror, automatic dimming feature **59**  
 Interior rearview mirror, compass **155**  
 Interior rearview mirror, manually dimmable **59**  
 Interval display, service requirements **82**  
 Jacking points for the vehicle jack **212**  
 Joystick, Steptronic transmission **72**  
 Jump-starting **216**

## K

Key/remote control **34**  
 Keyless Go, refer to Comfort Access **41**  
 Key Memory, refer to Personal Profile **35**  
 Kickdown, Steptronic transmission **72**  
 Knee airbag **96**

## L

Lamp replacement **206**  
 Lamp replacement, front **207**  
 Lamp replacement, rear **209**  
 Lane departure warning **114**  
 Lane margin, warning **114**  
 Language on Control Display **88**  
 Lashing eyes, securing cargo **172**  
 LATCH child restraint system **63**  
 Launch Control **74**  
 Leather, care **221**  
 LED light, bulb replacement **208**  
 LEDs, light-emitting diodes **207**  
 Length, vehicle **226**  
 Letters and numbers, entering **25**  
 Light alloy wheels, care **222**  
 Light control **92**  
 Light-emitting diodes, LEDs **207**  
 Lighter **157**  
 Lighting **91**  
 Lighting via remote control **38**  
 Light reel **91**  
 Lights **91**  
 Lights and bulbs **206**  
 Load **172**  
 Loading **171**  
 Loading aid **159**  
 Loading, see interior equipment **159**  
 Lock, door **39**  
 Locking/unlocking via door lock **39**  
 Locking/unlocking with remote control **37**  
 Locking, automatic **43**  
 Locking, settings **42**  
 Locking via trunk lid **40**

Low beams [91](#)  
 Low beams, automatic, refer to High-beam Assistant [93](#)  
 Lower back support [53](#)  
 Lumbar support [53](#)

## M

Maintenance [204](#)  
 Maintenance requirements [204](#)  
 Maintenance, service requirements [82](#)  
 Maintenance system, BMW [204](#)  
 Make-up mirror [157](#)  
 Malfunction displays, see Check Control [77](#)  
 Manual air distribution [146](#), [150](#)  
 Manual air flow [146](#), [150](#)  
 Manual mode, Steptronic transmission [73](#)  
 Manual operation, door lock [39](#)  
 Manual operation, exterior mirrors [58](#)  
 Manual operation, fuel filler flap [184](#)  
 Manual operation, Park Distance Control PDC [133](#)  
 Manual operation, rearview camera [136](#)  
 Manual operation, Side View [138](#)  
 Manual operation, Top View [139](#)  
 Marking on approved tires [195](#)  
 Marking, run-flat tires [196](#)  
 Master key, refer to Remote control [34](#)  
 Maximum cooling [149](#)  
 Maximum speed, display [83](#)  
 Maximum speed, winter tires [196](#)  
 Measure, units of [89](#)  
 Medical kit [216](#)  
 Memory, seat, mirror [57](#)  
 Menu, EfficientDynamics [177](#)  
 Menu in instrument cluster [85](#)  
 Menus, operating, iDrive [18](#)  
 Menus, refer to iDrive operating concept [20](#)  
 Messages, see Check Control [77](#)  
 Microfilter [147](#), [150](#)  
 Minimum tread, tires [194](#)  
 Mirror [58](#)  
 Mirror memory [57](#)  
 Mobile communication devices in the vehicle [169](#)  
 Modifications, technical, refer to Safety [7](#)  
 Moisture in headlight [207](#)  
 Monitor, refer to Control Display [18](#)  
 Mounting of child restraint systems [61](#)  
 Multifunction steering wheel, buttons [14](#)  
 Navigation, see user's manual for Navigation, Entertainment and Communication  
 Neck restraints, front, refer to Head restraints [56](#)  
 Neck warmer [54](#)  
 Neutral cleaner, see wheel cleaner [222](#)  
 New wheels and tires [195](#)  
 Nylon rope for tow-starting/towing [218](#)  
 Obstacle marking, rearview camera [136](#)  
 Octane rating, refer to Recommended fuel grade [186](#)  
 Odometer [81](#)  
 Office, see user's manual for Navigation, Entertainment and Communication  
 Oil [200](#)  
 Oil, adding [201](#)  
 Oil additives [201](#)  
 Oil change [202](#)  
 Oil change interval, service requirements [82](#)  
 Oil filler neck [201](#)  
 Oil types, alternative [202](#)  
 Oil types, approved [202](#)  
 Old batteries, disposal [213](#)  
 Onboard monitor, refer to Control Display [18](#)  
 Onboard vehicle tool kit [206](#)  
 Opening/closing via door lock [39](#)  
 Opening and closing [34](#)  
 Opening and closing, without remote control [39](#)  
 Opening and closing, with remote control [37](#)  
 Operating concept, iDrive [18](#)  
 Optional equipment, standard equipment [6](#)  
 Outside air, refer to Automatic recirculated-air control [149](#)  
 Overheating of engine, refer to Coolant temperature [81](#)

## P

Paint, vehicle [221](#)  
 Parallel parking assistant [140](#)  
 Park Distance Control PDC [132](#)  
 Parked-car ventilation [151](#)  
 Parked vehicle, condensation [170](#)

## O

OBD Onboard Diagnosis [204](#)  
 OBD, see OBD Onboard Diagnosis [204](#)

Parking aid, refer to PDC [132](#)  
 Parking assistant [140](#)  
 Parking brake [67](#)  
 Parking lights [91](#)  
 Passenger side mirror, tilting downward [58](#)  
 Pathway lines, rearview camera [136](#)  
 PDC Park Distance Control [132](#)  
 Pedestrian warning with city braking function [112](#)  
 Personal Profile [35](#)  
 Personal Profile, exporting profiles [36](#)  
 Personal Profile, importing profiles [36](#)  
 Pinch protection system, windows [45](#)  
 Plastic, care [222](#)  
 Power failure [213](#)  
 Power windows [45](#)  
 Pressure, tire air pressure [188](#)  
 Pressure warning FTM, tires [104](#)  
 Profile, refer to Personal Profile [35](#)  
 Programmable memory buttons, iDrive [24](#)  
 Protective function, windows [45](#)  
 Push-and-turn reel, refer to Controller [18, 19](#)

## R

Radiator fluid [203](#)  
 Radio-operated key, refer to Remote control [34](#)  
 Radio ready state [64](#)  
 Radio, see user's manual for Navigation, Entertainment and Communication  
 Rain sensor [70](#)  
 Rear lights [211](#)

Rear socket [158](#)  
 Rear turn signal, bulb replacement [209](#)  
 Rearview camera [135](#)  
 Rearview mirror [58](#)  
 Rear window defroster [146, 150](#)  
 Recirculated-air filter [150](#)  
 Recirculated-air mode [147, 149](#)  
 Recommended fuel grade [186](#)  
 Recommended tire brands [195](#)  
 Refueling [184](#)  
 Remaining range [81](#)  
 Remote control/key [34](#)  
 Remote control, malfunction [38](#)  
 Remote control, universal [153](#)  
 Replacement fuse [213](#)  
 Replacing parts [206](#)  
 Replacing wheels/tires [195](#)  
 Reporting safety defects [9](#), [شبانه](#)  
 RES button [127](#)  
 RES button, see Active Cruise Control, ACC [124](#)  
 RES button, see Cruise control [130](#)  
 Reserve warning, refer to Range [81](#)  
 Reset, Tire Pressure Monitor TPM [101](#)  
 Retaining straps, securing cargo [172](#)  
 Retreaded tires [195](#)  
 Roadside parking lights [92](#)  
 Rollover protection system [99](#)  
 RON recommended fuel grade [186](#)  
 Roofliner [17](#)  
 Rope for tow-starting/towing [218](#)

RSC Run Flat System Component, refer to Run-flat tires [196](#)  
 Rubber components, care [222](#)  
 Run-flat tires [196](#)

## S

Safe braking [169](#)  
 Safety [7](#)  
 Safety belt reminder for driver's seat and front passenger seat [56](#)  
 Safety belts [55](#)  
 Safety belts, care [222](#)  
 Safety systems, airbags [96](#)  
 Saving fuel [174](#)  
 Screen, refer to Control Display [18](#)  
 Screwdriver, see Onboard vehicle tool kit [206](#)  
 Screw thread, see screw thread for tow fitting, screw thread for tow fitting [219](#)  
 Seat and mirror memory [57](#)  
 Seat belts, refer to Safety belts [55](#)  
 Seat heating, front [54](#)  
 Seating position for children [61](#)  
 Seats [52](#)  
 Selection list in instrument cluster [85](#)  
 Selector lever, Steptronic transmission [72](#)  
 Sensors, care [223](#)  
 Service and warranty [8](#)  
 Service requirements, Condition Based Service CBS [204](#)  
 Service requirements, display [82](#)  
 Service, Roadside Assistance [216](#)  
 Services, ConnectedDrive



- Servotronic [123](#)
- SET button, see Active Cruise Control, ACC [124](#)
- SET button, see Cruise control [130](#)
- Settings, locking/unlocking [42](#)
- Settings on Control Display [88](#)
- Settings, storing for seat, mirror [57](#)
- Shift paddles on steering wheel [73](#)
- Side airbags [96](#)
- Side View [137](#)
- Signaling, horn [14](#)
- Signals when unlocking [43](#)
- Sitting safely [52](#)
- Size [226](#)
- Smallest turning radius [226](#)
- Snow chains [196](#)
- Socket [157](#)
- Socket, OBD Onboard Diagnostics [204](#)
- SOS button [215](#)
- Spare fuse [213](#)
- Specified engine oil types [202](#)
- Speed, average [86](#)
- Speed limit detection, computer [86](#)
- Speed limiter, display [83](#)
- Speed Limit Information [83](#)
- Speed Warning [87](#)
- Split screen [23](#)
- SPORT+ - program, Dynamic Driving Control [122](#)
- Sport displays, torque display, performance display [87](#)
- SPORT program, Dynamic Driving Control [122](#)
- Sport program, transmission [73](#)
- Sport steering, variable [121](#)
- Stability control systems [119](#)
- Start/stop, automatic function [66](#)
- Start/Stop button [64](#)
- Start function during malfunction [35](#)
- Starting the engine [65](#)
- Status control display, tires [101](#)
- Status information, iDrive [23](#)
- Status of Owner's Manual [6](#)
- Steering assistance [123](#)
- Steering wheel, adjusting [60](#)
- Steering wheel heating [60](#)
- Steptronic Sport transmission [73](#)
- Steptronic transmission [72](#)
- Stopping the engine [65](#)
- Storage compartment in the rear [165](#)
- Storage compartments [163](#)
- Storage compartments, locations [163](#)
- Storage, tires [196](#)
- Storing the vehicle [223](#)
- Summer tires, tread [194](#) تلفن شماره ۰۲۱-۳۳۳۳۳۳۳۳
- Sun visor [157](#)
- Supplementary text message [80](#)
- Surround View [135](#)
- Switch for Dynamic Driving [121](#)
- Switch-on times, parked-car ventilation [152](#)
- Switch, refer to Cockpit [14](#)
- Symbols [6](#)
- Symbols in the status field [23](#)
- ## T
- Tachometer [80](#)
- Tail lights [209](#)
- Technical changes, refer to Safety [7](#)
- Technical data [226](#)
- Telephone, see user's manual for Navigation, Entertainment and Communication
- Temperature, automatic climate control [146](#), [148](#)
- Temperature display for external temperature [81](#)
- Temperature, engine oil [80](#)
- Tempomat, refer to Active Cruise Control [124](#)
- Terminal, starting aid [217](#)
- Text message, supplementary [80](#)
- Theft alarm system, refer to Alarm system [43](#)
- Thigh support [53](#)
- Through-loading system [161](#)
- Tilt alarm sensor [44](#)
- Time of arrival [86](#)
- Tire damage [194](#)
- Tire identification marks [192](#)
- Tire inflation pressure [188](#)
- Tire inflation pressure monitor, refer to FTM [104](#)
- Tire Pressure Monitor TPM [100](#)
- Tires, changing [195](#)
- Tires, everything on wheels and tires [188](#)
- Tires, run-flat tires [196](#)
- Tire tread [194](#)
- Tone, see user's manual for Navigation, Entertainment and Communication
- Tool [206](#)
- Top View [138](#)
- Total vehicle weight [227](#)
- Touchpad [21](#)
- Tow fitting [219](#)
- Towing [218](#)
- Tow lug, see tow fitting [219](#)
- Tow-starting [218](#)
- TPM Tire Pressure Monitor [100](#)
- Traction control [120](#)

- TRACTION, driving dynamics **120**
- Transmission lock, electronic unlocking **74**
- Transmission, Steptronic transmission **72**
- Transporting children safely **61**
- Tread, tires **194**
- Trip computer **86**
- Triple turn signal activation **68**
- Trip odometer **81**
- Trunk, cargo area partition **48**
- Trunk lid closing **40**
- Trunk lid, emergency unlocking **41**
- Trunk lid, hotel function **40**
- Trunk lid opening **40**
- Trunk lid via remote control **38**
- Turning circle **226**
- Turning circle lines, rearview camera **136**
- Turn signals, operation **68**
- U**
- Unintentional alarm **44**
- Units of measure **89**
- Universal remote control **153**
- Unlock button, Steptronic transmission **72**
- Unlocking/locking via door lock **39**
- Unlocking/locking with remote control **37**
- Unlocking, settings **42**
- Updates made after the editorial deadline **6**
- Upholstery care **222**
- USB interface **158**
- V**
- Vanity mirror **157**
- Variable sport steering **121**
- Vehicle battery **212**
- Vehicle battery, replacing **212**
- Vehicle, break-in **168**
- Vehicle care **221**
- Vehicle features and options **6**
- Vehicle identification number **9**
- Vehicle jack **212**
- Vehicle paint **221**
- Vehicle storage **223**
- Vehicle wash **220**
- Ventilation **151**
- Ventilation, refer to Parked-car ventilation **151**
- VIN, see vehicle identification number **9**
- Voice activation system **26**
- W**
- Warning and indicator lamps, see Check Control **77**
- Warning displays, see Check Control **77**
- Warning messages, see Check Control **77**
- Warning triangle **216**
- Washer fluid **71**
- Washer nozzles, windshield **70**
- Washer system **69**
- Washing, vehicle **220**
- Water on roads **169**
- Weights **227**
- Welcome lights **91**
- Wheel base, vehicle **226**
- Wheel cleaner **222**
- Wheels, changing **195**
- Wheels, everything on wheels and tires **188**
- Wheels, Flat Tire Monitor FTM **104**
- Wheels, Tire Pressure Monitor TPM **100**
- Width, vehicle **226**
- Wind deflector **48**
- Window defroster, rear **146, 150**
- Windows, powered **45**
- Windshield washer fluid **71**
- Windshield washer nozzles **70**
- Windshield washer system **69**
- Windshield wiper **69**
- Winter storage, care **223**
- Winter tires, suitable tires **196**
- Winter tires, tread **194**
- Wiper **69**
- Wiper blades, replacing **206**
- Wiper fluid **71**
- Wiper, fold-out position **71**
- Wiper system **69**
- Wood, care **222**
- Word match concept, navigation **25**
- Wrench, see Onboard vehicle tool kit **206**
- xDrive **120**
- Xenon headlights, bulb replacement **207**

# امداد خودرو فارما

تلفن شبانه روزی: ۰۲۱-۸۸۸۶۲۰۸۵

**FarmaSOS.com**

More about BMW



The Ultimate  
Driving Machine

bmwusa.com

# امداد خودرو فارما

تلفن شبانه روزی: ۰۲۱-۸۸۸۶۲۰۸۵

[FarmaSOS.com](http://FarmaSOS.com)

01 40 2 956 860 ue

