

Owner's Manual  
for Vehicle



# امداد خودرو فارما

تلفن شبانه روزی: ۰۸۵-۸۸۸۶۲-۰۲۱

**FarmaSOS.com**

**525i**  
**530i**  
**545i**

Congratulations, and thank you for choosing a BMW.

Thorough familiarity with your vehicle will provide you with enhanced control and security when you drive it. We therefore have this request:

Please take the time to read this Owner's Manual and familiarize yourself with the information that we have compiled for you before starting off in your new vehicle. It contains important data and instructions intended to assist you in gaining maximum use and satisfaction from your BMW's unique range of technical features. The manual also contains information on maintenance designed to enhance operating safety and contribute to maintaining the value of your BMW throughout an extended service life.

This Owner's Manual should be considered a permanent part of this vehicle. It should stay with the vehicle when sold to provide the next owner with important operating, safety and maintenance information.

This manual is supplemented by a Service and Warranty Information Booklet for US models or a Warranty and Service Guide Booklet for Canadian models.

We wish you an enjoyable driving experience.

BMW AG

تلفن شبانه روزی: ۰۲۱-۸۸۸۶۲۰۸۵

[FarmaSOS.com](http://FarmaSOS.com)

# امداد خودرو فارما

تلفن شبانه روزی: ۰۸۵-۸۸۸۶۲-۰۲۱

[FarmaSOS.com](http://FarmaSOS.com)

© 2003 Bayerische Motoren Werke  
Aktiengesellschaft  
Munich, Germany  
Reprinting, including excerpts, only with the  
written consent of BMW AG, Munich.  
Order No. 01 41 0 157 647  
US English VIII/03 5 10  
Printed in Germany  
Printed on environmentally friendly paper,  
bleached without chlorine, suitable for recycling.

# Contents

The fastest way to find specific topics is to use the index, refer to page 202.

## Using this Owner's Manual

- 4 Notes
- 7 Reporting safety defects

## At a glance

- 10 Cockpit
- 16 Control Center
- 20 Voice command system

## Controls

- 26 Opening and closing
- 36 Adjustments
- 45 Transporting children safely
- 49 Driving
- 65 Everything under control
- 76 Technology for comfort, convenience and safety
- 87 Lamps
- 90 A congenial climate
- 96 Practical interior accessories

## Driving tips

- 106 Things to remember when driving

## Navigation

- 114 Starting navigation system
- 116 Destination entry
- 123 Destination guidance
- 127 What to do if ...

## Entertainment

- 130 On/off, tone
- 134 Radio
- 141 CD Compact Disc
- 144 CD changer

## Communications

- 150 Telephoning
- 161 TeleService, BMW Assist

## Mobility

- 168 Refueling
- 170 Wheels and tires
- 177 Under the hood
- 181 Maintenance
- 183 Rules and regulations
- 184 Replacing components
- 190 Giving and receiving assistance

## Reference

- 198 Technical data
- 202 Everything from A to Z

تلفن شبانه روزی: ۰۸۵-۸۸۶۲۰۸۱-۰۲۱

FarmaSOS.com

# Notes

## Using this Owner's Manual

We have made every effort to ensure that you are able to find what you need in this Owner's Manual as quickly as possible. The fastest way to find specific topics is to use the detailed index at the back of the manual. If you wish to gain an initial overview of your vehicle, you will find this in the first chapter.

Should you want to sell your BMW some day, please remember to hand over the Owner's Manual as well; it is an important component of your vehicle.

### Additional sources of information

Should you have any other questions, your BMW center will be glad to advise you at any time.

You can find information on BMW, e.g. technology, on the Internet at [www.bmwusa.com](http://www.bmwusa.com).

## Symbols used



Indicates precautions that must be followed precisely in order to avoid the possibility of personal injury and serious damage to the vehicle.

◀ Marks the end of a specific item of information.



Contains information that will assist you in gaining the optimum benefit from your vehicle and enable you to care more effectively for your vehicle.



Refers to measures that can be taken to help protect the environment.

\* Indicates special equipment, country-specific equipment and optional extras when available.

"..." Identifies Control Display texts used to select individual functions.

### Symbols on vehicle components



Indicates that you should consult the relevant section of this Owner's Manual for information on a particular part or assembly.

FarmaSOS.com

## The individual vehicle

On purchasing your BMW, you have decided in favor of a model with individualized equipment and features. This Owner's Manual describes the entire array of options and equipment available with a specific BMW model.

Please bear in mind that the manual may contain information on accessories and equipment that you have not specified for your own vehicle. Sections describing options and special equipment are marked by asterisks \* to assist you in identifying possible differences between the descriptions in this manual and your own vehicle's equipment.

Should your BMW be equipped with features or accessories not described in this manual, please consult the enclosed supplementary manual(s).

## Editorial notice

BMW pursues a policy of continuous, ongoing development that is conceived to ensure that our vehicles continue to embody the highest quality and safety standards combined with advanced, state-of-the-art technology. For this reason, the features described in this Owner's Manual may differ from those on your vehicle. Nor can errors and omissions be entirely ruled out. You are therefore asked to appreciate that no legal claims can be entertained on the basis of the data, illustrations or descriptions in this Owner's Manual.

امداد خودرو فارما

تلفن شبانه روزی: ۰۸۵-۸۸۸۶۲-۰۲۱

FarmaSOS.com

## For your own safety

### Fuels

 Use unleaded gasoline only. Fuels containing up to and including 10% ethanol or other oxygenates with up to 2.8% oxygen by weight – that is, 15% MTBE or 3% methanol plus an equivalent amount of co-solvent – will not void the applicable warranties with respect to defects in materials or workmanship. Field experience has indicated significant differences in fuel quality – volatility, composition, additives, etc. – among gasolines offered for sale in the United States and Canada. The use of poor-quality fuels may result in driveability, starting and stalling problems, especially under certain environmental conditions such as high ambient temperature and high altitude.

Should you encounter driveability problems which you suspect could be related to the fuel you are using, we recommend that you respond by switching to a recognized high-quality brand.

Failure to comply with these recommendations may result in unscheduled maintenance.

Follow the relevant safety rules when you are handling gasoline. ◀

### Maintenance and repair

 Advanced technology, e.g. the use of modern materials and high-performance electronics, requires specially adapted maintenance and repair methods. Therefore, only have corresponding work on your BMW carried out by a BMW center or a workshop that works according to BMW repair procedures with correspondingly trained personnel. If work is carried out improperly there is a danger of consequential damage and the related safety risks. ◀

## Parts and accessories

 For your own safety, use genuine parts and accessories approved by BMW.

When you purchase accessories tested and approved by BMW and Genuine BMW Parts, you simultaneously acquire the assurance that they have been thoroughly tested by BMW to ensure optimum performance when installed on your vehicle.

BMW warrants these parts to be free from defects in material and workmanship. BMW will not accept any liability for damage resulting from installation of parts and accessories not approved by BMW.

BMW cannot test every product made by other manufacturers to verify if it can be used on a BMW safely and without risk to either the vehicle, its operation, or its occupants.

Genuine BMW Parts, BMW Accessories and other products approved by BMW, together with professional advice on using these items, are available from all BMW centers.

Installation and operation of non-BMW approved accessories such as alarms, radios, amplifiers, radar detectors, wheels, suspension components, brake dust shields, telephones – including operation of any portable phone from within the vehicle without using an externally mounted antenna – or transceiver equipment, for instance, CBs, walkie-talkie, ham radio or similar accessories, may cause extensive damage to the vehicle, compromise its safety, interfere with the vehicle's electrical system or affect the validity of the BMW Limited Warranty. Consult your BMW center for additional information. ◀

 Maintenance, replacement, or repair of the emission control devices and systems may be performed by any automotive repair establishment or individual using any certified automotive part. ◀



## Service and warranty

We recommend that you read this publication thoroughly.

Your BMW is covered by the following warranties:

- ▷ New Vehicle Limited Warranty
- ▷ Rust Perforation Limited Warranty
- ▷ Federal Emissions System Defect Warranty
- ▷ Federal Emissions Performance Warranty
- ▷ California Emission Control System Limited Warranty.

Detailed information about these warranties is listed in the Service and Warranty Information Booklet for US models or in the Warranty and Service Guide Booklet for Canadian models.

## Reporting safety defects

The following only applies to vehicles owned and operated in the US.

If you believe that your vehicle has a defect which could cause a crash or could cause injury or death, you should immediately inform the National Highway Traffic Safety Administration NHTSA in addition to notifying BMW of North America, LLC, P.O. Box 1227, Westwood, New Jersey 07675-1227, Telephone (800) 831-1117.

If NHTSA receives similar complaints, it may open an investigation, and if it finds that a safety defect exists in a group of vehicles, it may order a recall and remedy campaign. However, NHTSA cannot become involved in individual problems between you, your dealer, or BMW of North America, LLC.

To contact NHTSA, you may either call the Auto Safety Hotline toll-free at 1-800-424-9393 (or 366-0123 in Washington, D.C. area) or write to: NHTSA, U.S. Department of Transportation, Washington, D.C. 20590. You can also obtain other information about motor vehicle safety from the Hotline.

FarmaSOS.com



# امداد خودرو فارما

تلفن شبانه روزی: ۰۲۱-۸۸۸۶۲۰۸۵

[FarmaSOS.com](http://FarmaSOS.com)

## At a glance

This overview of buttons, switches and displays is intended to serve as a source of orientation in your vehicle's operating environment. The section will also assist you in becoming acquainted with the control concepts and options available for operating the various systems.



تلفن شبانه روزی: ۰۲۱-۸۸۸۶۲۰۸۵

FarmaSOS.com

# Cockpit

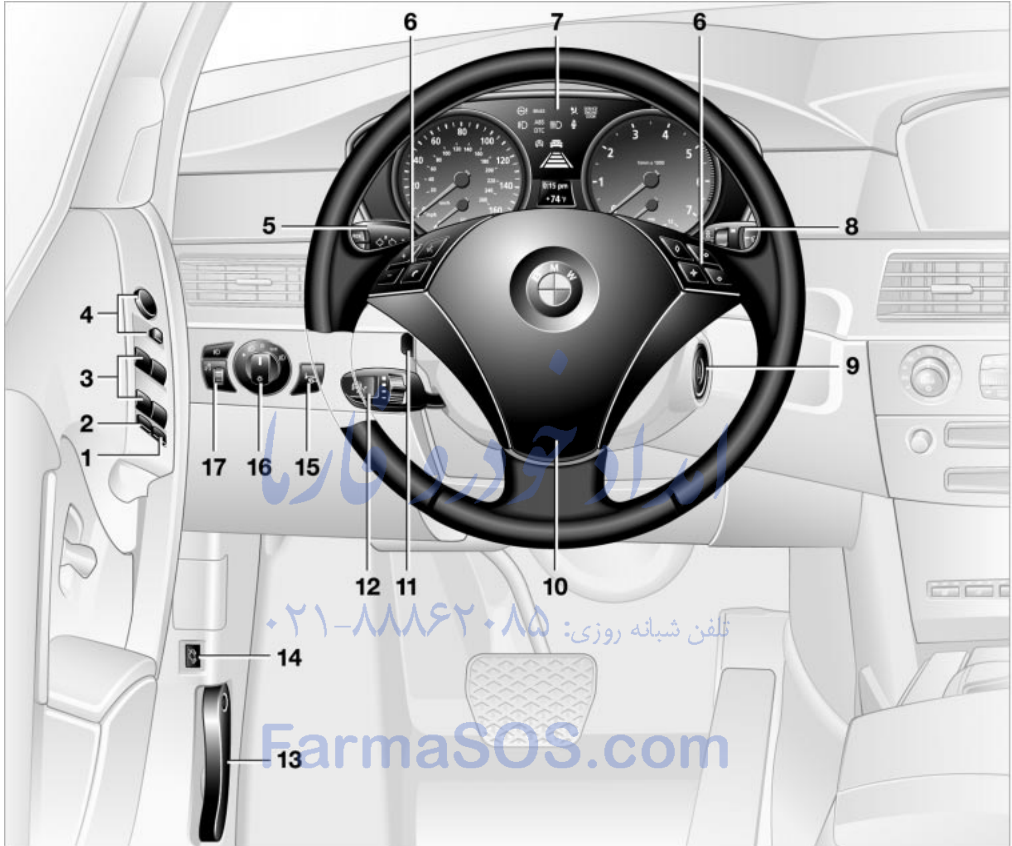
## All around the steering wheel: controls and displays



- |   |                                  |    |   |   |                              |    |
|---|----------------------------------|----|---|---|------------------------------|----|
| 1 | Roller sun blind for rear window | 97 | 5 |  | Turn signal indicators       | 56 |
| 2 | Rear window safety switch        | 34 |   |  | High beams, headlamp flasher | 88 |
| 3 | Electric power windows           | 33 |   | CHECK   | Check Control                | 68 |
| 4 | Adjusting exterior mirrors       | 42 |   | BC  | Computer                     | 70 |
|   |                                  |    |   |  | Standing lamps               | 88 |

## 6 Buttons on steering wheel



Portable phone\*:

- ▷ Accepting a call
- ▷ Start calling
- ▷ Ending call.



Volume



Voice command system.



Fast forward/reverse:

- ▷ Radio  
Press briefly: change station  
Press longer: manual tuning or automatic search scan
- ▷ CD  
Press briefly: select track  
Press longer: fast forward/reverse.



Individually programmable, refer to page 44.



- ▷ Individually programmable, refer to page 44
- ▷ Voice instructions for navigation.

## 7 Instrument cluster 12

### 8 Windshield wipers 57

### Rain sensor 57

## 9 Ignition lock 49

## 10 Horn: the entire surface

### 11 Steering wheel heater 44

### Steering wheel adjustment 43

### 12 Cruise control 58

### Active cruise control 59

## 13 Opening the hood 177

## 14 Opening the luggage compartment lid 31

### 15 Head-Up Display 85

### 16 Parking lamps and low beams 87

### 17 Instrument lighting 88

### Front fog lamps 89

## Instrument cluster

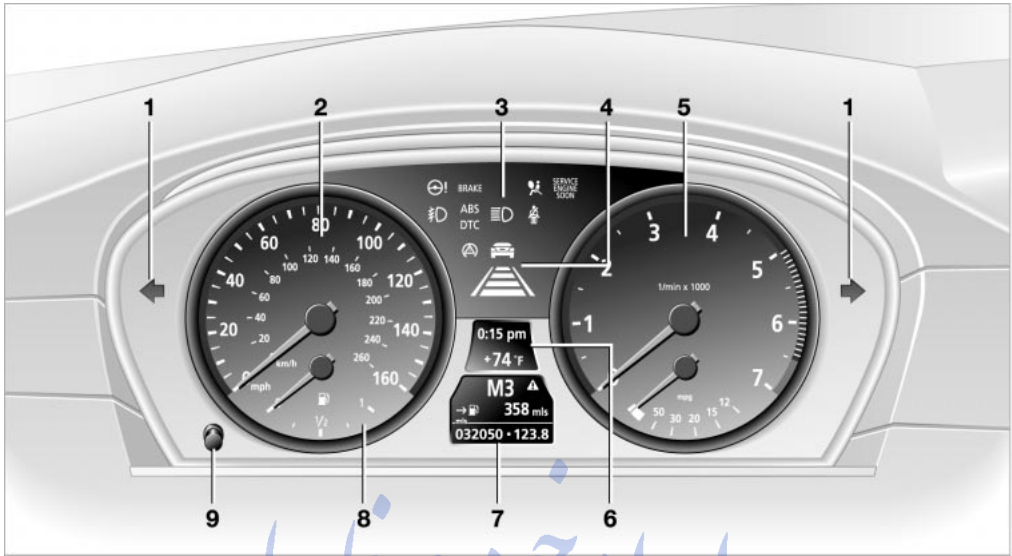

- 1 Indicator lamps for turn signal indicators 13
- 2 Speedometer with display of speed for
  - ▷ Cruise control 58
  - or
  - ▷ Active cruise control 59
- 3 Indicator and warning lamps 13
- 4 Display for active cruise control 60
- 5 Tachometer with variable advance warning field and Energy Control 65
- 6 Display for
  - ▷ Indicator and warning lamps of the Check Control 68
  - ▷ Speed of the cruise control 58
  - ▷ Desired speed for active cruise control 60
  - ▷ Clock/date 65
  - ▷ Outside temperature 65
- 7 Display for
  - ▷ Automatic transmission 54
  - ▷ Sequential manual transmission 53
  - ▷ Computer 70
  - ▷ Date and remaining distance for service requirement 66
  - ▷ Trip odometer/odometer 65
  - ▷ Check Control message present 68
- 8 Fuel gauge 66
- 9 To set trip odometer to zero and reset for service requirement display 65

# Indicator and warning lamps

## Technology that monitors itself

The indicator and warning lamps identified by the ● symbol are subjected to an operation check each time you switch on the ignition or start the engine. They each light up once for different periods of time.

When a malfunction occurs in a monitored system, the corresponding lamp will either fail to go out when the engine is started, or it will come on again during normal driving. For information on how you should respond when this happens, please refer to the pages indicated.



Turn signal indicators ● 56



Active steering ● 82



Handbrake/brake fluid, brake hydraulics/DBC Dynamic Brake Control ● 50/ 180/ 79



Handbrake/brake fluid, brake hydraulics/DBC Dynamic Brake Control for Canadian models



Airbags ● 83



Service Engine Soon ● 183  
If the indicator lamp comes on either continuously or intermittently, this indicates a fault in the emissions-related electronic systems. Although the vehicle remains operational, you should have the systems checked by your BMW center at the earliest possible opportunity.



Service Engine Soon indicator lamp for Canadian models.



Front fog lamps 89



ABS Antilock Brake System ● 77



DTC Dynamic Traction Control 79



High beams/headlamp flasher 88



Please fasten safety belt ● 40



DSC Dynamic Stability Control ● 78



Check Gas Cap 168  
lamp for US models

## Colors

The indicator and warning lamps can light up in different colors and combinations. The following section explains the significance of the individual colors as well as how you should respond when they appear.

- ▷ Red:  
Stop immediately or important reminder
- ▷ Red and yellow:  
Continue driving moderately
- ▷ Yellow: *تلفن شناسه*  
Have checked soon or for your information
- ▷ Green or blue:  
For your information.

## Indicator and warning lamps of the Check Control



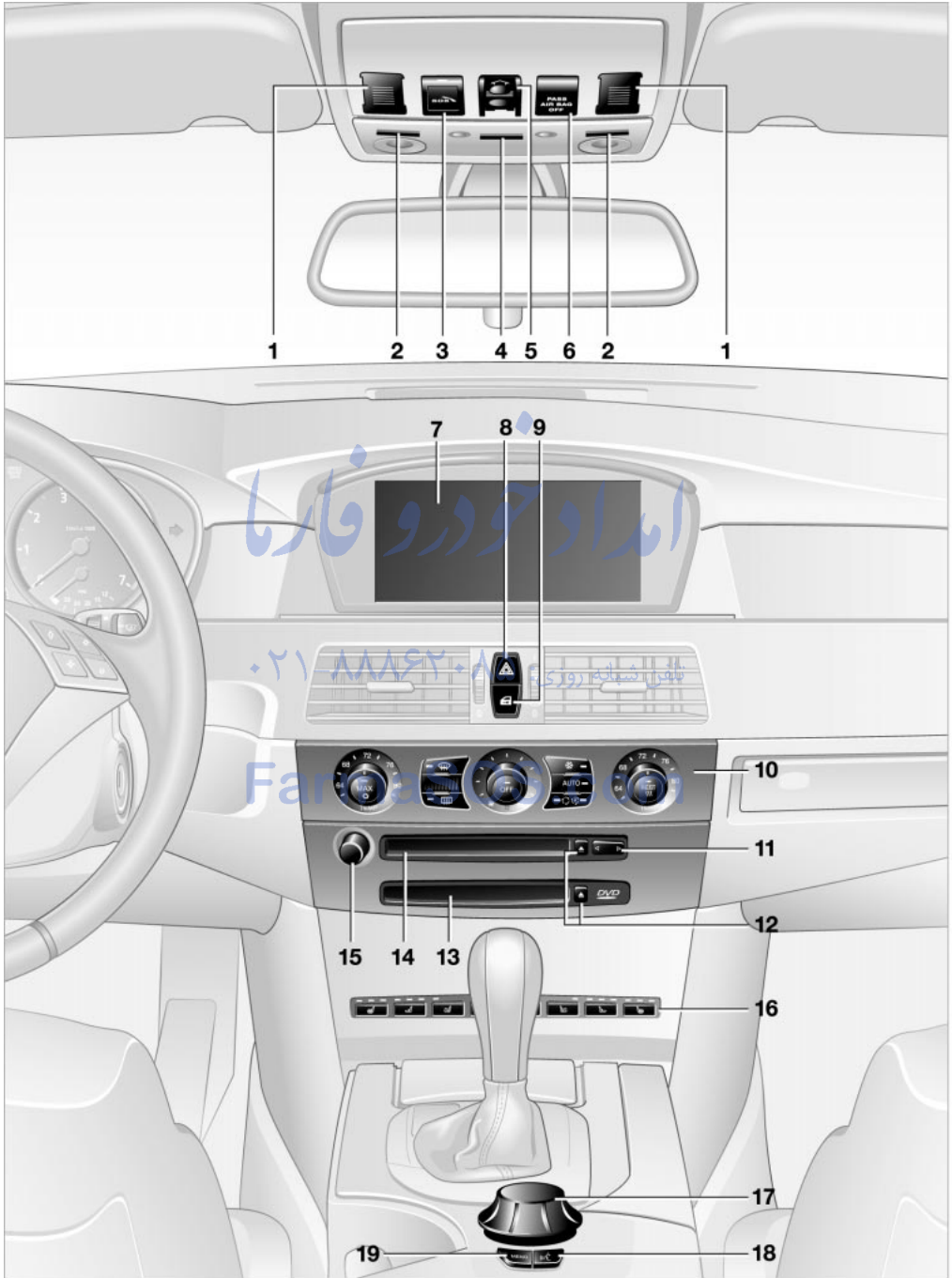

Other indicator and warning lamps appear in display 6 of the instrument cluster as necessary, accompanied by supplementary text on the Control Display, refer to Check Control, page 68.

# Comfort area: controls and displays









- 1 Microphone for
  - ▷ Telephone/portable phone 151
  - ▷ Voice command system 20
- 2 Reading lamps 89
- 3 Starting emergency call 190
- 4 Interior lamps 89
- 5 Glass roof, electric 34
- 6 Front passenger's airbag indicator lamp 84
- 7 Control Display 16  
displays for menu guidance
- 8 Hazard warning flashers
- 9 Central locking system 30
- 10 Automatic climate control 90

- TEMP Temperature setting, left/right 91
- AUTO Automatic air distribution and supply 91
-  Cooling function 91
-  Automatic recirculated-air control AUC 91
- MAX Maximum cooling 91
- REST Residual heat mode 92
- OFF To switch off automatic climate control 92
-  Air volume 91
-  Defrost windows 91
-  Rear window defroster 90

- 11 Button for
  - ▷ Station scan/track search 130
  - ▷ CD player 141
  - ▷ CD changer 145

- 12 Ejecting
  - ▷ Navigation CD/DVD 114
  - ▷ Audio CD 130
- 13 Drive for navigation CD/DVD 114
- 14 Drive for audio CD 130
- 15 Switching audio sources on/off and adjusting the volume 130
- 16 Center console switching center
  -  Heated seats 41
  -  Active seat ventilation 42
  -  Active seat 42
  -  PDC Park Distance Control 76
  -  DSC Dynamic Stability Control 78
- 17 Controller 16  
Horizontal movement in four directions, turn or press
- 18 Activating voice command system 20
- 19 Open start menu 17

ایراد خودرو فارس  
 تلفن شبانه روزی: ۰۸۳۰۶۲۸۸۹۱  
 فارسSOS.com

# Control Center

The Control Center groups the functions of a large number of switches. This means that these functions can be operated from a central position. The following section provides an introduction to the principle of the menu guidance. How you control the individual functions is described in the context of the relevant equipment.

## Controls

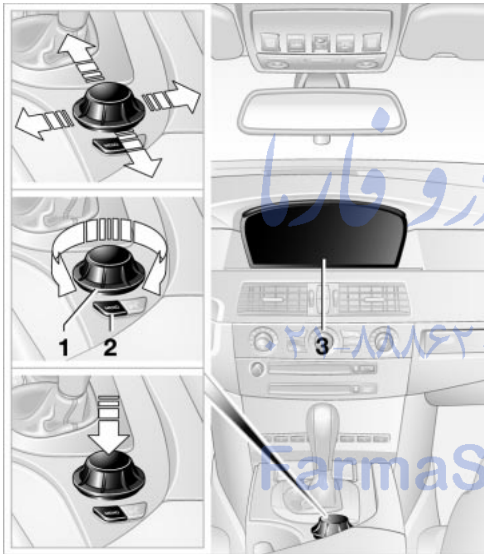

- 1 Controller: you navigate through the menus of the Control Center and make adjustments by turning, pressing and moving it to the left, right, forwards or backwards
- 2 Opening the start menu from any menu item
- 3 Control Display

When you turn the controller, you feel a clicking. This helps you to select the desired menu item.

**⚠** To avoid posing an unnecessary hazard due to inattention, both to your own vehicle's occupants and to other road

users: never attempt to use the controls or make entries unless traffic and road conditions allow. ◀

## Menu overview

You can call up all the functions in the Control Center using five menu items.

### Communication

- ▷ Portable phone\*
- ▷ BMW Assist\* or TeleService\*.

### Navigation or onboard information

- ▷ Navigation system\*
- ▷ Onboard information, e.g. for display of the average fuel consumption.

### Entertainment

- ▷ Radio
- ▷ CD.

### Climate

- ▷ Air distribution
- ▷ Seat air conditioning\*
- ▷ Independent ventilation\*.

### Menu item i

- ▷ Switching off the Control Display
- ▷ Traffic information
- ▷ Sound and display settings
- ▷ Settings for your vehicle, e.g. Key Memory
- ▷ Display of the maintenance requirement and dates for statutory emission and vehicle inspections.

# Menu guidance

As of ignition key position 1, the following message appears on the Control Display:

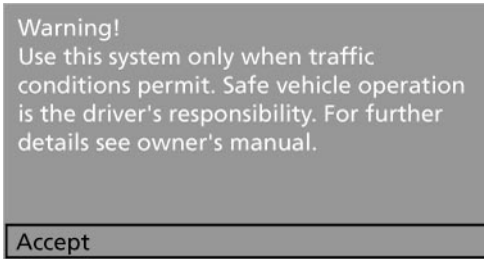

Confirm the message by pressing the controller; the start menu is opened.

## Start menu

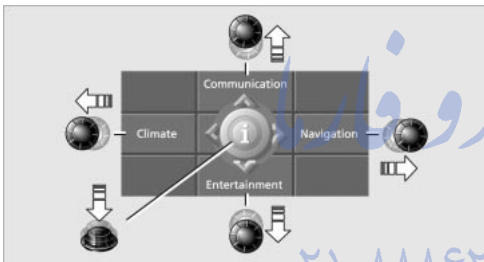

In ignition key position 2: Via the start menu, you can open four menus by moving the controller to the left, right, forwards or backwards. Pressing the controller opens the **i** menu.

Calling up the start menu:



Press button.

Opening the start menu from the **i** menu:



Press the button twice.

# Displays on the Control Display

## A menu

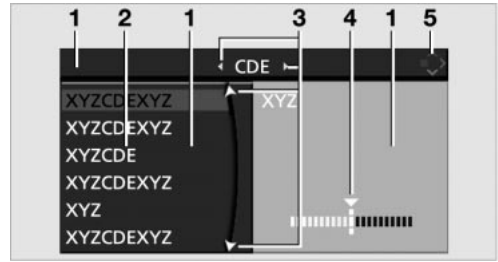

- 1 In menus, you can change fields to select the menu items they contain or to make adjustments. The active field is brighter than the others
- 2 Menu items are usually grouped in horizontal or vertical lists
- 3 Arrows indicates that other menu items can be selected in lists, but these are not visible at the moment
- 4 Adjustments are displayed in diagrams or as numbers
- 5 A symbol indicates the last selected menu item of the start menu

- Communication
- Navigation or onboard information
- Entertainment
- Climate
- i** menu

## Status information

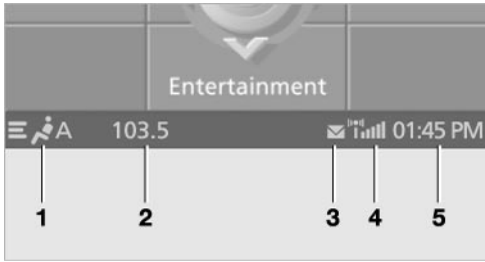

- 1 Manual or automatic air distribution for driver and passenger side
- 2 Display for Entertainment: Radio and CD or Entertainment off  
Display for telephone: Name of network operator with display for roaming:  
 Roaming active
- 3 SMS received
- 4 Reception of portable phone network and emergency call possible  
 SOS: emergency call possible  
no display: emergency call not possible
- 5 Current time

If information is issued by the Check Control or inputs are made using the voice command system, a text message appears here on the Control Display.

## Assistance window

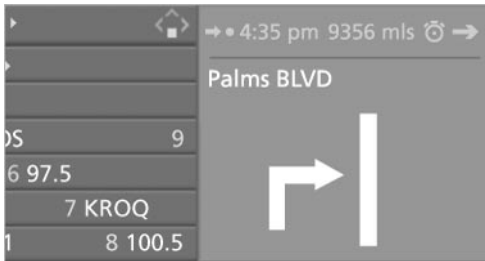

While you are operating whatever functions you like using the Control Center, you can obtain the following additional information in the assistance window:

- ▷ Short help and supplementary information texts for selected menu entries

- ▷ The computer or trip computer
- ▷ The travel route in vehicles with navigation system
- ▷ The current position.

To select the display in the assistance window:

1. Move the controller to the right to switch to the assistance window and press the controller

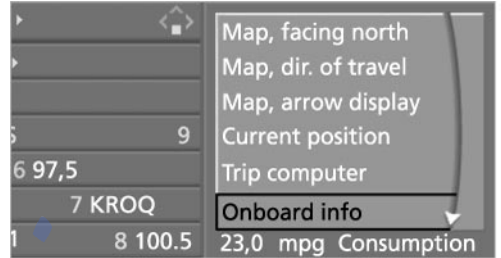

2. Select the menu item and press the controller.

## Switching Control Display on/off

To switch off the Control Display:

1. Open the start menu
2. Open the menu by pressing the controller

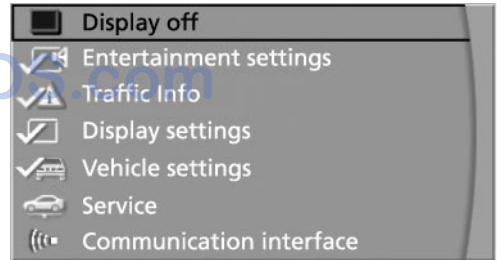

3. Select "Display off" and press the controller.  
The status informations continue to be displayed.

To switch on the Control Display:  
Press the controller.

## Selecting menu items and making adjustments



- 1 To select individual menu items: turn the controller. The marking moves. Menu items shown in white can be selected
  - 2 To activate menu items selected with the marking: press the controller. In the current field, new menu items are displayed or a function is executed
  - 3 To change the current field: move the controller to the left, right, forwards or backwards and let go
  - 4 To select menu items, cf. 1: turn the controller. The marking moves
  - 5 To make adjustments: turn the controller. A graphical display, numerical values or text displays change. The adjustment is adopted if you change the field or switch into another menu
-  If you hold the controller for longer than approx. 2 seconds in one position, the menu that lies in that direction will be opened. ◀

# Voice command system\*

## The concept

The voice command system allows you to control operation of various vehicle systems without ever removing your hands from the steering wheel.

The menu items on the Control Display serve as voice commands for the equipment that can be operated using the voice command system. This means you can open these menu items using the voice command system instead of with the controller.

The voice command system transforms your oral commands into control signals for the selected systems and provides support in the form of instructions or questions.

### Precondition

If the language of the voice command and Control Display do not match, change the language of the Control Display, refer to page 74.

### Symbols used

-  ›...‹ Identifies voice commands.
- ››...‹‹ Identifies instructions generated by the voice command system.

## Voice commands

### Activating voice command system



Briefly press the  button on the steering wheel or in the center console.

If voice command is to come from the passenger side:

Press the button in the center console for a longer period.



 This symbol on the Control Display and an acoustic message indicate that you can enter voice commands.



The text or numbers that the voice command system has registered will appear at this position on the Control Display.

 This symbol appears on the Control Display when you can enter additional voice commands.

If there are no other voice commands, operate the equipment using the Control Center.

### Canceling voice command system

Press the  button on the steering wheel or in the center console

or

 ›Cancel‹.

While notes are being recorded, canceling is only possible using one of the  buttons.

## Voice commands

You can have the system list the possible voice commands:



 ›Options‹.

In addition to the commands described in this Owner's Manual, alternative commands are often possible for the same functions, e.g.:

 ›Radio on‹ or ›Switch on radio‹.

You can use short commands to make it easier to run certain functions.

### An example: selecting a radio station

1. Switch on radio
2. Press the  button on the steering wheel or in the center console
3.  ›Entertainment‹.  
The system issues:  
››Entertainment‹‹



-  4. ›AM‹.  
The system issues:  
››AM‹‹



-  5. Select the station, e.g.:  
▷ ›Frequency 95 Point 5‹.  
The system issues:  
››95.5‹‹.

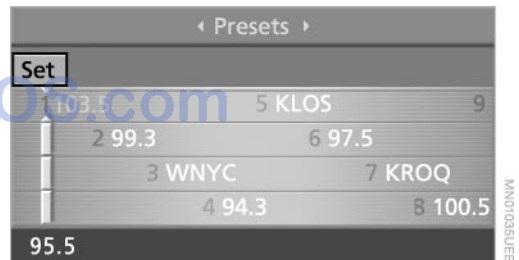



اراد خودرو فارما

تلفن شبانه روزی: ۰۲۱-۸۸۶۲۰۸۵

FarmaSoft.com

## Notes

 Do not use the voice command system in emergency situations. In stress situations, voice and pitch can change. Instead, use the emergency call button near the interior rearview mirror. ◀

 At the time of going to press, the voice command system was available in English. Other languages are currently not available.  
The telephone can also be operated using voice control, refer to page 157. ◀

### Important for voice commands

Issue the commands fluently and at normal volume, avoiding excessing emphasis and pauses.

The voice command system uses a special hands-free microphone located in the front of your vehicle's headliner. On vehicles with telephone, two vehicle microphones are fitted. Although the system is designed to filter out ambient noise, you can help ensure that your commands will be understood by observing the following instructions:

- ▷ Keep the doors, windows and glass roof closed to prevent interference from ambient noise
- ▷ Avoid other sources of noise in the vehicle while speaking, and ask other vehicle occupants to refrain from talking while you are using the system
- ▷ Without a telephone, the vehicle microphone is directed at the driver. This means that the system might not be able to register the voices of other vehicle occupants properly.



# امداد خودرو فارما

تلفن شبانه روزی: ۰۲۱-۸۸۸۶۲۰۸۵

**FarmaSOS.com**



# امداد خودرو فارما

تلفن شبانه روزی: ۰۲۱-۸۸۸۶۲۰۸۵

[FarmaSOS.com](http://FarmaSOS.com)

## Controls

This chapter is intended to provide you with information for complete control of your vehicle. Its extensive array of features and accessories, both for driving and for your own safety, comfort and convenience, are described here.

تلفن شبانه روزی: ۰۲۱-۸۸۸۶۲۰۸۵

FarmaSOS.com

# Opening and closing

## The key set

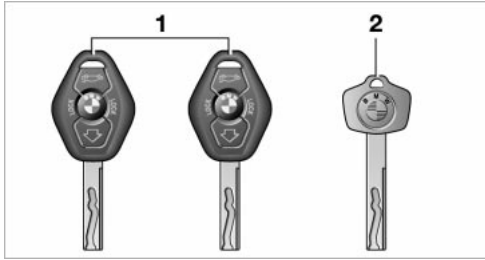

- 1 Central keys with remote control. They specify the functions of the Key Memory. In the process individual functions of your vehicle can behave differently depending on the key used, see further below.

You can mark the keys with remote control using the color-coded decals you received on taking delivery of the vehicle



Each central key with remote control is equipped with an extended-life battery, which is automatically recharged in the ignition lock each time you drive the vehicle.

If you have any central keys with remote control that are not used on a regular basis, you should therefore remember to recharge these units by using them to drive the vehicle for an extended period at least once a year, refer to page 29. ◀

- 2 Spare key for storage in a safe place, such as in your wallet.  
This key cannot be used to open the locks for the luggage compartment lid and glove compartment. This is an advantage in a hotel, for example. The key is not intended for constant use

## Key Memory

### How the system functions

Doubtless you have often reflected on how great it would be if you could configure your vehicle's various adjustment settings to meet your own personal requirements. BMW has designed several freely selectable options into the vehicle during its development. You can set these as desired via the Control Center.

You can have up to four different basic settings adjusted for four different persons for the specific keys. The only requirement is that each person uses his or her own central key with remote control. Additional keys are available at your BMW center.

When your vehicle is unlocked with the remote control, the vehicle recognizes the individual user by means of a data exchange with the key, and makes adjustments accordingly.

### To differentiate

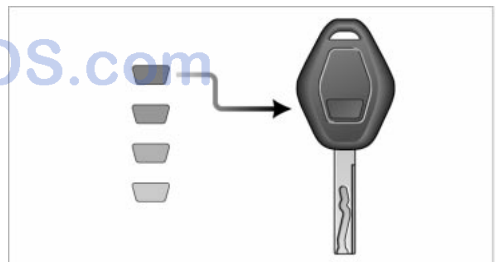

Color-coded decals are provided to help you distinguish the individual central keys with remote control with their different settings.

## Examples of Key Memory functions

- ▷ Automatic adjustment of the electric driver's seat
- ▷ Locking the vehicle after moving off
- ▷ When unlocking with the remote control, either unlock only the driver's door or the entire vehicle
- ▷ Activating optical warning for Park Distance Control PDC
- ▷ Setting the volume.

## Central locking system

### The concept

The central locking system is ready for operation whenever the driver's door is closed. This simultaneously engages and releases the locks on the following:

- ▷ Doors
- ▷ Luggage compartment lid
- ▷ Fuel filler door.

The central locking system can be operated from the outside

- ▷ via the remote control
- ▷ via the driver's door lock

and from inside via the button for the central locking system.

When the system is locked from inside, the fuel filler door remains unlocked, refer to page 30.

The anti-theft system is automatically activated whenever you operate the central locking system from outside the vehicle. It prevents the doors from being unlocked using the safety lock buttons or door handles. The alarm system is armed/disarmed at the same time.

In the event of an accident, the central locking system automatically unlocks the vehicle. In addition, the hazard warning flashers and interior lamps come on.

## Opening and closing: from outside

### Using the remote control

The remote control provides two additional functions for the central locking system:

- ▷ Switching on the interior lamps, refer to page 28.  
You can also use this function to locate your vehicle in parking garages etc.
- ▷ Opening the luggage compartment lid, refer to page 28.  
The luggage compartment lid opens, regardless of whether it was previously locked or unlocked.

In addition, the remote control offers you another function:

- ▷ Panic mode  
In case of danger, you can trigger an alarm.

When you lock/unlock the vehicle, you simultaneously activate/deactivate the anti-theft system, arm/disarm the alarm system, and switch the interior lamps on/off.

 Protect the remote control against unauthorized use by handing over only the spare key, for example when using hotel valet parking. ◀

 Because any persons or animals left unattended in a parked vehicle could lock the doors from the inside, you should always keep the remote control with you; this precaution ensures that you will remain able to unlock the vehicle from the outside at all times. ◀

### Unlocking

Press the  button.

You can set which doors are to be unlocked for each specific key:

Control Center, for principle details, refer to page 16:

1. Open the **i** menu
2. Select "Vehicle settings" and press the controller

3. Select "Door locks" and press the controller
4. Select "Central locking" and press the controller

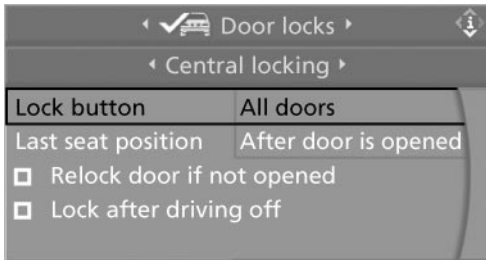

5. Select "Lock button" and press the controller
6. Select the doors and press the controller:
  - ▷ "All doors"
  - ▷ "Driver's door only"

Press the button twice to unlock the entire vehicle after the driver's door.

displays the selected doors.

### Convenience opening mode

Press and hold the button. The windows and the glass roof open.

### Locking and securing

Press the button.

### Switching on the interior lamps

If the vehicle is locked, press the button.

### Switching off the tilt alarm sensor and interior motion sensor

Press the button once again directly after locking.

For more detailed information, refer to page 33.

### Panic mode

By pressing and holding the button for more than approx. two seconds, you can trigger the alarm system in response to any impending danger.

To switch off the alarm: press any of the buttons.

### Opening the luggage compartment lid

Press the button.

The luggage compartment lid opens, regardless of whether it was previously locked or unlocked.

During opening, the luggage compartment lid pivots upward and to the rear. Ensure that adequate clearance is available before opening.

Before and after a trip, ensure that the luggage compartment lid has not been opened unintentionally.

A locked luggage compartment lid is also locked again after closing. ◀

### Setting the confirmation signals

You can have various confirmation signals programmed into the system to verify that the vehicle has been unlocked or locked securely.

Control Center, for principle details, refer to page 16:

1. Open the menu
2. Select "Vehicle settings" and press the controller
3. Select "Door locks" and press the controller
4. Select "Confirmation" and press the controller

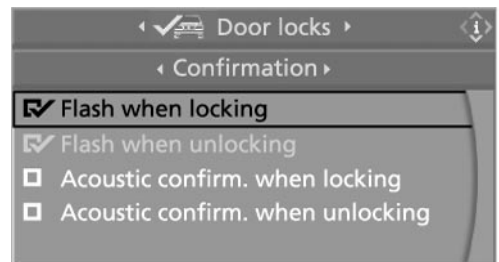

5. Select the desired signal and press the controller.

indicates the signals switched on.

## Malfunctions

External systems or devices may cause local interference in the functions of the remote control.

Should the remote control fail to operate owing to interference of this kind, you can respond by using the central key to unlock your vehicle at one of the doors.

In the event of a system malfunction, please contact your BMW center, which is also your source for replacement keys.

When it is no longer possible to lock the vehicle via the remote control, the battery is discharged. Use this remote control during an extended drive; this will recharge the battery, refer to page 26.

### For US owners only

The transmitter and receiver units comply with part 15 of the FCC/Federal Communication Commission regulations. Operation is governed by the following:

FCC ID: LX8766S  
LX8766E  
LX8CAS

Compliance statement:

This device complies with part 15 of the FCC Rules. Operation is subject to the following two conditions:

- ▷ This device may not cause harmful interference, and
- ▷ this device must accept any interference received, including interference that may cause undesired operation.

 Any unauthorized modifications or changes to these devices could void the user's authority to operate this equipment. ◀

## Using the door lock

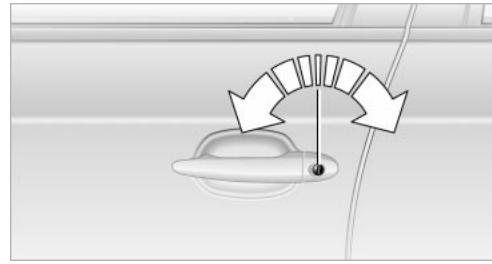

 Do not lock the vehicle when persons are inside, as the vehicle cannot be unlocked from inside. ◀

One turn of the key in the driver's door lock unlocks the driver's door only. Turning the key a second time unlocks all of the remaining doors, the luggage compartment lid and the fuel filler door.

### Convenience operation

You also have the option of operating the windows and the glass roof from the driver's door lock.

▷ To open:

With the door closed, turn the key to the unlock position and hold it there

▷ To close:

With the door closed, turn the key to the lock position and hold it there.

 Watch during the closing process to be sure that no one is injured. Releasing the key stops the operation. ◀

### Manual operation

In the event of an electrical malfunction You can turn the key all the way to the right or left in the door lock to lock or unlock the driver's door.

## Opening and closing: from inside

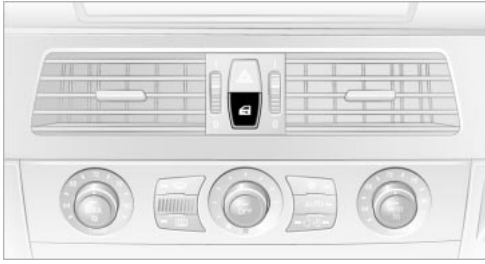

MN02722CMA

You can operate the central locking system with this button when the front doors are closed. This only unlocks or locks the doors and luggage compartment lid, but not secured. Also, the fuel filler door remains unlocked to allow refueling.

You can also make the following settings for each specific key:

- ▷ The central locking system automatically locks the vehicle as soon as you drive off
- ▷ The central locking system automatically locks the vehicle after a short time when no door has been opened.

Control Center, for principle details, refer to page 16:

1. Open the **i** menu
2. Select "Vehicle settings" and press the controller
3. Select "Door locks" and press the controller
4. Select "Central locking" and press the controller

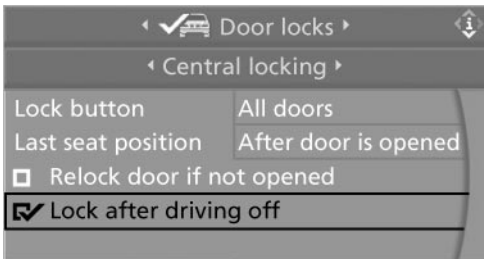

MN10164UEA

5. Select "Lock after driving off" or "Relock door if not opened" and press

the controller.

displays the selected setting.

### Unlocking and opening the doors

- ▷ Either unlock the doors together with the button for the central locking system and then pull the door handle above the armrest or
- ▷ pull the door handle twice at each individual door: the first pull unlocks the door, the second pull opens it.

### Locking

- ▷ Use the central locking button to lock all of the doors simultaneously, or
- ▷ press down the individual safety lock buttons. To prevent you from being locked out, the open driver's door cannot be locked using the safety lock button.



Because any persons or animals left unattended in a parked vehicle could lock the doors from the inside, you should always keep the remote control with you; this precaution ensures that you will remain able to unlock the vehicle from the outside at all times. ◀



## Luggage compartment lid

### Opening from inside



Press the button: the luggage compartment lid opens unless it has been secured.

 During opening, the luggage compartment lid pivots upward and to the rear. Ensure that adequate clearance is available before opening. ◀

### Opening from outside

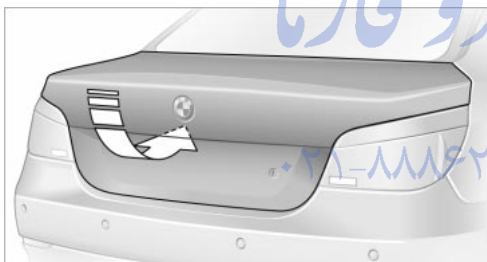

Press the button: the luggage compartment lid opens.

 During opening, the luggage compartment lid pivots upward and to the rear. Ensure that adequate clearance is available before opening. ◀

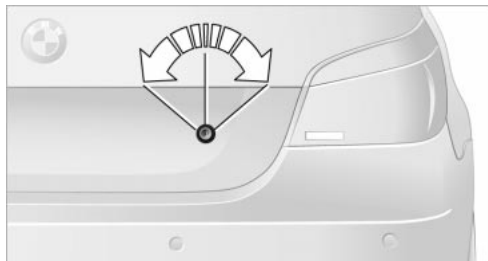

Only the central keys with remote control, refer to page 26, match the luggage compartment lock.

### Securing separately

Turn the central key with remote control in the lock of the luggage compartment lid beyond a resistance point to the right and withdraw it from a horizontal position.

This locks the luggage compartment lid and disconnects it from the central locking system.

If you then only hand over the spare key, refer to page 26, no access is possible via the luggage compartment lid. This is an advantage in a hotel, for example.

### Double-unlocking, manual operation

Turn the central key to the left as far as it will go: the luggage compartment lid opens.

 If you use the key to unlock the luggage compartment lid while the alarm system is armed, the alarm will be triggered. Switching off the alarm, refer to page 32. ◀

## Emergency release



This lever releases the luggage compartment lid from inside the luggage compartment.

## Closing



The handle recesses on the interior trim of the luggage compartment lid make it easier to pull down.

**⚠** To avoid injuries, be sure that the travel path of the luggage compartment lid is clear when it is closed, as with all closing procedures. ◀

**⚠** Operate the vehicle only when the luggage compartment lid is completely closed. Otherwise, exhaust fumes could penetrate the interior of the vehicle. ◀

If special circumstances should make it absolutely necessary to operate the vehicle with the compartment open:

1. Close all windows and the glass roof
2. Adjust the automatic climate control to supply a high air volume, refer to page 91.

## Alarm system

### The concept

The vehicle alarm system responds:

- ▷ When a door, the hood, or the luggage compartment lid is opened
- ▷ To movement in the vehicle interior: interior motion sensor
- ▷ To changing the vehicle's tilt if someone attempts to steal the wheels or tow the vehicle
- ▷ To interruption of battery voltage.

The system responds to unauthorized vehicle entry and attempted theft by simultaneously activating:

- ▷ An acoustic alarm, which lasts for a period of approx. 30 seconds
- ▷ The hazard warning flashers for approx. 5 minutes
- ▷ The high beams, which flash on and off in the same rhythm.

### Arming and disarming the alarm system

When you lock or unlock the vehicle, either with the remote control or at the door lock, the alarm system is armed or disarmed at the same time.

The system indicates that it has been correctly armed by switching on the hazard warning flashers for a single cycle and by emitting an acoustic signal.

You can also open the luggage compartment lid with the system armed using the  button on the remote control, refer to page 28. When you close the lid, it is secured again.

### Switching off the alarm

- ▷ Unlock the vehicle using the remote control, refer to page 27
- ▷ Or turn the ignition key to position 1.

## Indicator lamp displays



VM02701040M

- ▷ The indicator lamp beneath the interior mirror flashes continuously: the system is armed
- ▷ If the indicator lamp flashes during arming: doors, engine hood or luggage compartment lid are not properly closed. Even if you do not close the alerted area, the system begins to monitor the remaining areas, and the indicator lamp flashes continuously after approx. 10 seconds. However, the interior motion sensor is not activated
- ▷ If the indicator lamp goes out on disarming: no manipulation or attempted intrusions have been detected in the period since the system was armed
- ▷ If the indicator lamp flashes on disarming until the key is inserted in the ignition lock, but for approx. 5 minutes at the most: your vehicle has been manipulated in the meantime.

Following triggering of an alarm, the indicator lamp will flash continuously.

### Avoiding unintentional alarms

The tilt alarm sensor and interior motion sensor may be switched off at the same time. You can do this to prevent a false alarm from being triggered in garages with elevator ramps, for instance, or when the vehicle is transported by trailer or train:

Lock, i.e. arm twice. Press the  Lock button on the remote control twice in succession, refer to page 27, or lock twice with the key, refer to page 30.

The indicator lamp lights up briefly and then flashes continuously. The tilt alarm sensor and the interior motion sensor are

switched off as long as the system is armed.

### Interior motion sensor

In order for the interior motion sensor to function properly, the windows and glass roof must be completely closed.

However, switch the interior motion sensor off, refer to Avoiding unintentional alarms, if

- ▷ children or animals are to remain in the vehicle
- ▷ the windows or glass roof are to remain open.

## Windows

### Opening and closing windows

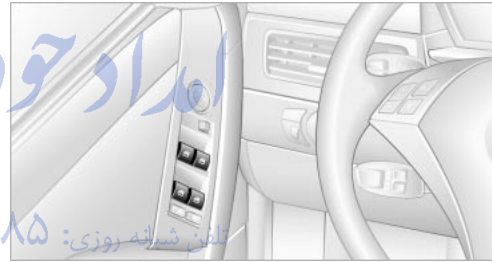

VM026963CM

As of ignition key position 1:

- ▷ Press the switch up to the resistance point:  
The window continues to move downward as long as you continue to hold the switch
- ▷ Briefly press the switch beyond the resistance point:  
The window moves downward automatically. Press the switch again to stop the opening movement.

You can close the windows in the same manner by pulling the switch.

### After switching off the ignition

You can still operate the windows:

- ▷ In the radio position for a longer time
- ▷ For approx. 1 minute in position 0 or with the ignition key removed.

To open, press the switch beyond the resistance point.

 When leaving the vehicle parked, always remove the central key with remote control from the ignition lock and close the doors; this precaution prevents children from operating the power windows and injuring themselves etc. ◀

For information on using the convenience operation mode at the door lock or with the remote control, refer to page 28 or 29.

### Safety feature

If the closing force rises beyond a pre-defined threshold during closing, the system will immediately stop moving the window prior to lowering it slightly.

 Despite this safety feature you should always inspect the window's travel path prior to closing it, as the safety system might fail to detect certain kinds of obstructions, such as very thin objects, and the window would continue closing.

Pulling the switch beyond the resistance point and holding it limits the response of the safety feature.

Under these conditions the window will respond to forces beyond a defined threshold by only opening several inches/millimeters.

If you again pull the switch past the resistance point and hold it in position within a period of roughly 4 seconds, the safety feature is deactivated. ◀

### Safety switch



With the safety switch, you can prevent the rear windows from being opened or closed via the switches in the rear passenger area,

by children, for example. The indicator lamp lights up when this safety feature is activated.

 Press the safety switch whenever children are riding in the rear of the vehicle. Careless use of the power windows can lead to injury. ◀

 You can deactivate the function again as of ignition key position 1. ◀

### Accessories in the window area

After installing any accessory – such as a clamp-on antenna for a portable phone – within the window's travel range, you will need to have the system reinitialized for use under the new conditions. Please contact your BMW center for assistance.

### Glass roof, electric\*

 To prevent injuries, exercise care when closing the glass roof and keep it in your field of vision until it is shut.

When leaving the vehicle, always remove the remote control and close the doors to prevent children from operating the glass roof and injuring themselves, etc. ◀

### Raising, opening, closing



As of ignition key position 1, press the switch, or slide it in the desired direction up to the resistance point.

### After switching off the ignition

You can still operate the roof:

- ▷ In the radio position for a longer time
- ▷ For approx. 1 minute in position 0 or with the ignition key removed.

The headliner insert slides back somewhat when you raise the glass roof. When the glass roof is opened the headliner retracts with it.



Do not use force to close the headliner insert with the glass roof in its raised position, as damage to the mechanism could result. ◀

For information on using the convenience operation mode at the door lock or with the remote control, refer to page 28 or 29.

### Automatic\* opening and closing

Briefly press the switch past the resistance point and then release it.

In addition, the following movements are also automatic:

- ▷ With the glass roof open, move the switch towards 'Raise': the glass roof moves to the end position of 'Raise'
- ▷ With the glass roof raised, move the switch towards 'Open': the glass roof moves to the end position of 'Open'.

Press the switch again in any direction to stop the glass roof.

### Safety feature

If the glass roof encounters resistance when closing from roughly the center of the roof opening or when closing from the raised position, the closing action is interrupted and the glass roof reopens a little.



Despite this safety feature, you should always inspect the glass roof's travel range prior to closing it, as the safety feature might fail to detect certain kinds of obstructions, such as very thin objects, and the glass roof would continue closing. Pressing the switch beyond the resistance point and holding it limits the response of the safety feature. The glass roof only opens a short distance.

If you again press the switch past the resistance point and hold it in position within a period of roughly 2 seconds, the safety feature is deactivated. ◀



When you close the glass roof, it will slow down as it approaches the end

of its travel path; this is to allow the safety feature to respond more precisely to any obstructions encountered in this critical area. ◀

### Following interruptions in electrical power supply

Following interruptions in electrical power supply, for instance, when the battery is disconnected, it is possible that the glass roof will extend to its raised position, but fail to respond to other commands. Should this occur, please have the glass roof reinitialized at your BMW center.

### Manual operation

In the event of an electrical malfunction, you can operate the glass roof manually:



1. Fold the cover downwards



2. Insert the Allen wrench supplied with the onboard tool kit, refer to page 184, in the opening provided. Turn to slide the glass roof in the desired direction.

# Adjustments

## Sitting safely

The ideal sitting position can make a vital contribution to relaxed, fatigue-free driving. The sitting position of the occupants plays an important role together with the safety belts and airbags in an accident. To ensure that the safety systems operate with optimal efficiency, we strongly urge you to observe the instructions contained in the following section.

For additional information on transporting children safely, refer to page 45.

### Sitting safely with airbags

 Always maintain an adequate distance between yourself and the airbags. Always hold the steering wheel by its rim with hands at the 9 o'clock and 3 o'clock positions, to minimize the risk of injuries to your hands and arms in the event of airbag deployment.

No one and nothing is to come between the airbags and the seat occupant.

Do not use the cover of the front airbag on the front passenger side as a storage area. Make sure that the front passenger is correctly seated and does not rest feet or legs on the instrument panel, otherwise leg injuries can occur if the knee and front airbag are triggered.

Never let an occupant's head rest near or on a side airbag because the inflating airbag could cause a serious or fatal injury. ◀

Even if you adhere to all the instructions injuries resulting from contact with airbags cannot be fully excluded, depending on the circumstances. The ignition and inflation noise may provoke a mild hearing loss in extremely sensitive individuals. This effect is usually only temporary.

For airbag locations and additional information on airbags, refer to page 83.

## Sitting safely with safety belts

Fasten your safety belt before starting any trip. Airbags complement the safety belt as an additional safety device, but they do not represent a substitute.

Your vehicle has five seats that are all equipped with a safety belt.

 At all times, occupants should sit upright and be properly restrained – infants and small children in appropriate child-restraint systems; larger children and adults using the safety belts.

Expectant mothers should always wear their safety belts, taking care to position the lap belt against the lower hips, where it will not exert pressure against the abdominal area.

Never allow more than one person to wear a single safety belt. Never allow infants or small children to ride in a passenger's lap. Do not route the belt across your neck, or run it across sharp edges. Be sure that the belt does not become caught or jammed.

Avoid twisting the belt while routing it firmly across the hips and shoulder. Do not allow the belt to rest against hard or fragile objects. Otherwise, in the event of a frontal impact, a loose lap belt could slide over your hips, leading to abdominal injury.

Avoid wearing clothing that prevents the belt from fitting properly and pull the lap belt periodically to readjust the tension across your shoulder in order to avoid a reduction in the retention effect of the safety belt. ◀

For instructions on operating safety belts, refer to page 40.

## Seats

### Note before adjusting

 Never attempt to adjust your seat while the vehicle is moving. The seat could respond with unexpected move-

ment, and the ensuing loss of vehicle control could lead to an accident.

On the front passenger side as well, do not tilt the backrest too far toward the rear while driving. Failure to observe this precaution can prevent the belt from providing effective protection against injury, as the passenger could slide under the belt in an accident.

Make sure that the footwell behind the driver's and front passenger's seat is empty and unobstructed. If you fail to do so, any persons or objects behind the seat could be injured or damaged by a rearward movement of the seat. ◀

Please observe the information on damage to safety belts provided on page 41 and the information on the active head restraints on page 40.

## Seat adjustment

 To ensure that the safety systems continue to provide optimized protection, please observe the adjustment instructions on page 36. ◀

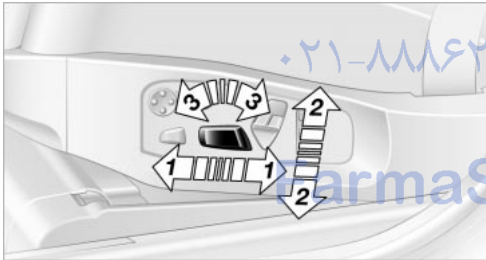

- 1 Forward/backward
- 2 Height
- 3 Angle



- 4 Backrest

## Comfort seat\* adjustment

In addition to the electric power seat functions, several other adjustment options are available with the comfort seat:

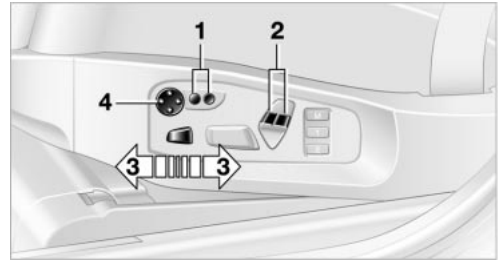

- 1 Backrest width  
By adjusting the backrest width, you can increase or reduce lateral support
- 2 Shoulder support  
You can use the adjustable upper backrest for supplementary support in the shoulder region. This provides a relaxed driving position and helps relieve stress on the shoulder muscles

 Make corrections in the forward/backward adjustment of the seat to ensure that the safety belt still fits firmly against your body. If you do not do this, the protection provided by the safety belt may be reduced. ◀

- 3 Thigh support  
Adjust the thigh support until the ideal support is provided for the thigh
- 4 Lumbar support, see below

## Sports seat\* adjustment

In addition to the seat cushion, on the sports seat you can adjust the thigh support 3, see above.

## Easy entry/exit\*

The backrest width automatically moves as high up and far forward as possible to ease driver entry and exit before then returning to the standard or stored memory setting.

This automatic feature is governed by the driver's door and the ignition lock.

## Lumbar support\* adjustment



You can also adjust the contours of the backrest to obtain additional support in the lumbar region.

The upper hips and spinal column receive supplementary support to help you maintain a relaxed, upright sitting position.

- ▷ Press the front/rear of the switch to strengthen or weaken the curvature
- ▷ Press the upper/lower end of the switch to strengthen the curvature at the top or bottom.

## Seat, mirror and steering wheel memory\*

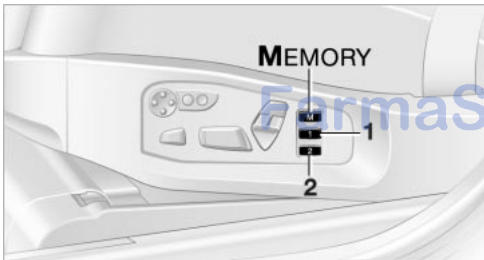

You can store and select two different adjustment settings for the driver's seat, exterior mirrors and steering wheel.

The adjustment of the lumbar support is not stored in the memory.

### Storing

1. Turn the ignition key to position 1 or 2
2. Set the desired seat, exterior mirror and steering-wheel positions

3. Press the **MEMORY** button:  
The indicator lamp in the button lights up
4. Press the desired memory button **1** or **2**:  
The indicator lamp goes out.

### Calling up a stored setting

 Do not call up a position from the memory while the vehicle is moving. Otherwise there is a risk of accident from unexpected movement of the seat or steering wheel. ◀

### Convenience mode

1. Open the driver's door after unlocking or turn the ignition key to position 1
2. Briefly press the desired memory button **1** or **2**.

The system immediately cancels the adjustment procedure when you press one of the seat adjustment buttons or use one of the memory buttons.

When the respective last driver's seat, exterior mirror and steering-wheel position is called up can be set for each key.

Control Center, for principle details, refer to page 16:

1. Open the **i** menu
2. Select "Vehicle settings" and press the controller
3. Select "Door locks" and press the controller
4. Select "Central locking" and press the controller
5. Select "Last seat position" and press the controller



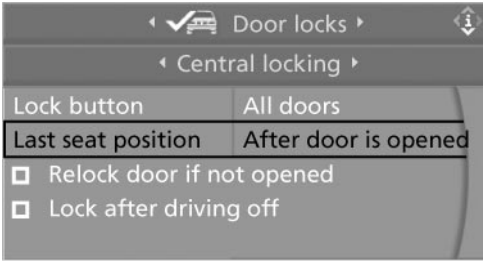

MMN01065UEA

mirror on the front passenger side tilts downward slightly. This allows the driver to see the area immediately adjacent to the vehicle – such as a curb – when parking, etc.

You can also deactivate this automatic function: push the mirror selector switch to the passenger's mirror position.

- Select "After unlocking" or "After door is opened" and press the controller.

displays the selected setting.

**!** When using this Key Memory feature, always make sure that the footwell behind the driver's seat is empty and unobstructed. If you fail to do so, any persons or objects behind the seat could be injured or damaged by a rearward movement of the seat. ◀

### Safety feature

- Close the driver's door and turn the ignition key to position 0 or 2
- Press the desired memory button 1 or 2 and maintain pressure until the adjustment process has been completed.

If the **MEMORY** button is pressed accidentally:

Press the button a second time, the indicator lamp goes out.

### Passenger-side exterior mirror tilt function\*

Automatic curb monitor

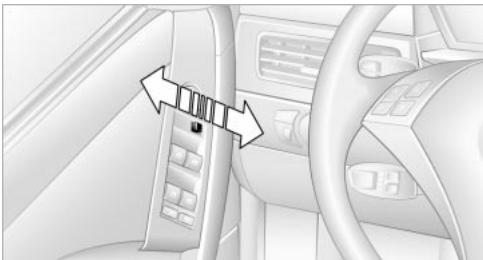

MMV02898CMA

- Select the exterior mirror on the driver side with the switch
- When you engage reverse gear or selector-lever position R, the exterior

## Head restraints

**!** Head restraints reduce the risk of spinal injury in the event of an accident. Adjust the head restraints so that they are centered roughly at the level of your ears. ◀

### Front seats: adjusting the height

You can adjust the height of the head restraints electrically.

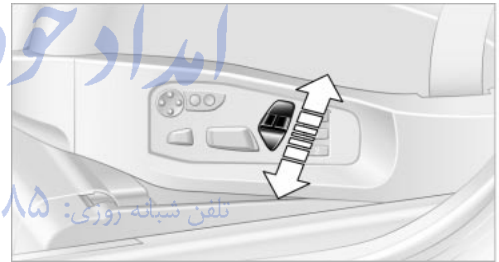

MMV01927CMA

### Front seats: adjusting the angle

Swivel the head restraint.

With the comfort seat, you use the shoulder support to set the distance to the back of the head.

## Comfort seat

### Setting the side extensions

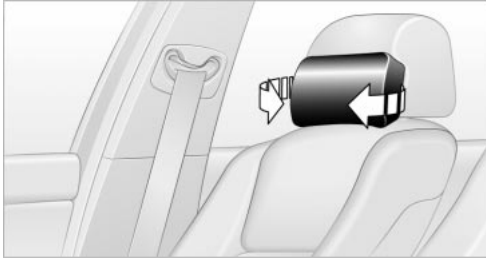

You can fold the side extensions on the head restraint forward for increased lateral support.

### Front head restraints, active\*

The comfort seats are equipped with an active head restraint.

When necessary, the system will respond to a rear impact by automatically triggering the active head restraints.

 To ensure that the active head restraints afford maximum protection, and to avoid unnecessary risks to personal safety, we request that you read and comply with the following:

- ▷ Adjust the head restraints so that they are centered roughly at the level of your ears
- ▷ Do not install seat or head-restraint covers
- ▷ Never use the head restraints as supports for suspending objects of any kind, such as clothes hangers. Refrain from mounting accessories on either the seat or the head restraint. ◀

## Rear seats: adjusting the height

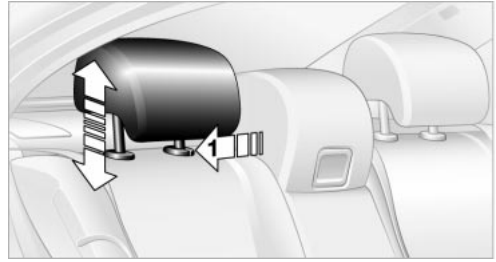

- ▷ Upwards: by pulling
- ▷ Downwards: press the button, arrow 1, and press the head restraint downwards.

## Safety belts



### Fastening

Make sure you hear the latch plate engage in the belt buckle.



Please fasten safety belts warning lamp:  
Lights up until the driver and front passenger have fastened their seat belts. Depending on the model, a signal\* sounds or a message\* appears on the Control Display at the same time.

The warning is also issued when the driver or front passenger removes his or her safety belt while driving.



The warning can also be issued when objects are laid on the front passenger seat. ◀

## Releasing

1. Press the red button in the belt buckle
2. Hold the belt firmly
3. Guide the belt into its reel.

The upper shoulder strap's anchorage point will be in the correct position for seat occupants of every build if the seat is correctly adjusted, refer to page 36.

The two rear safety belt buckles integrated in the rear seat are for passengers sitting on the left and right. The belt buckle embossed with the word CENTER is intended exclusively for use by passengers riding in the center position.

## Damage to safety belts



If the safety belts are damaged or stretched in an accident: have the entire belt system, including the tensioning mechanisms, replaced at your BMW center. Have the belt anchorage points inspected for damage at the same time. Failure to observe this precaution may prevent the safety belts from effectively providing optimal protection when needed. ◀

## Heated seats\*

### Front



The system regulates the temperatures of the seat cushion and backrest.

The temperature setting progresses one step through its control sequence each time you press the button.

To switch off:

Maintain pressure on the button for several seconds.

### Rear

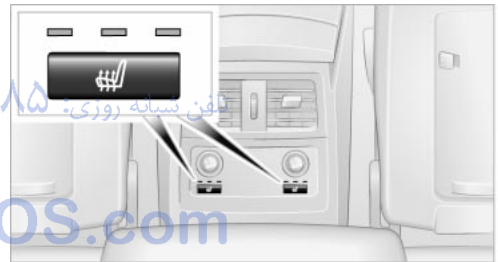

The operating concept is the same as for the front heated seats.

## Temperature distribution at the front

It is possible to select a temperature-distribution pattern, providing different levels of heating for the seat cushion and the backrest according to your wishes.

Control Center, for principle details, refer to page 16:

1. Open "Climate"
2. Select "Seat heater distribution" and press the controller

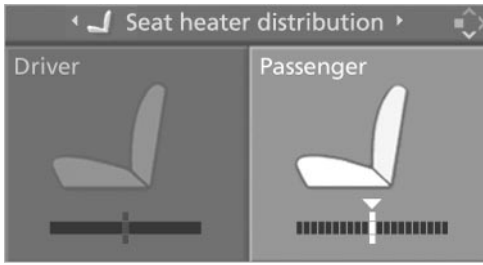

3. Move the controller to the left or right to select "Driver" or "Passenger"
4. Turn the controller. The adjustment is adopted; the field can be changed.

### Active seat ventilation\*

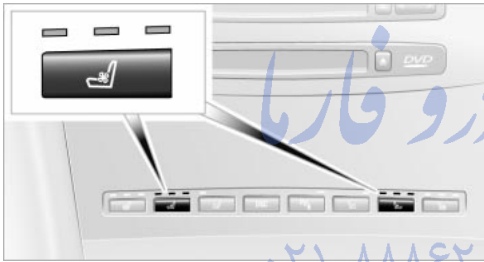

The system progresses one step through the control sequence each time you press the button.

To switch off:  
Maintain pressure on the button for several seconds.

- ▶ Use level 3 to cool the passenger compartment rapidly, for instance, when heat accumulates in the vehicle. After a short time, there is an automatic return to level 2 to prevent undercooling of the occupant's back. ◀

### Active seat\*



The seat cushion is actively varied by alternately raising and lowering the right and left half of the seat cushion. This reduces muscular tension and fatigue to help prevent lower back pain.

Center console:

To activate, press the button; the indicator lamp lights up.

If you switch off the active seat, it can take up to 1 minute before the two halves of the seat cushion have returned to their initial position.

### Mirrors

#### Adjusting exterior mirrors

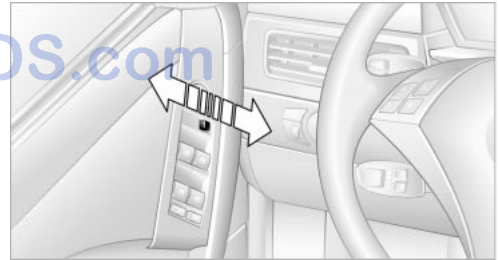

Arm rest in the driver's door:

- 1 4-way adjustment
- 2 To select mirror for adjustment

⚠ To prevent the exterior mirrors on this vehicle from being damaged, always fold them in by hand before entering an automatic car wash. ◀

You can also adjust the mirrors manually by pressing against the outer edges of their lenses.

Storing the mirror positions, refer to Seat, mirror and steering wheel memory on page 38.

 The mirror on the passenger's side features a lens with a more convex surface than the mirror installed on the driver's side. When estimating the distance between yourself and other traffic, bear in mind that the objects reflected in the mirror are closer than they appear. This means that estimations of the distance to following traffic should not be regarded as precise. ◀

### Self-defrosting mirrors

Both exterior mirrors are automatically heated in ignition key position 2.

### Interior rearview mirror

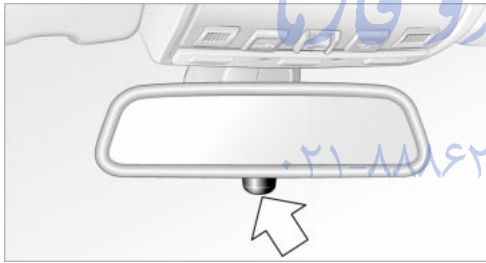

To reduce the dazzle effect of following vehicles at night, turn the knob beneath the mirror.

### Interior and exterior mirrors, automatic dimming feature\*

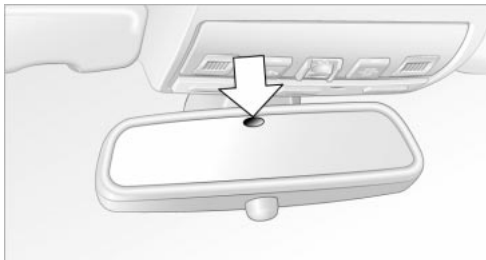

These mirrors automatically respond to ambient light and headlamp glare from fol-

lowing vehicles by automatically dimming through an infinitely-variable range. There are two photocells located in the interior rearview mirror for this purpose. One is integrated within the mirror's lens, while the other is located at an offset position on the rear of the mirror housing.

The mirrors automatically revert to their clear, undimmed mode whenever you engage reverse gear or place the selector lever into position R.

 For trouble-free operation, keep the photocells clean and do not cover the area between the interior rearview mirror and the windshield. Do not attach any kind of stickers on the windshield in front of the mirror. ◀

### Steering wheel adjustment

 Do not adjust the steering wheel while the vehicle is moving. There is a risk of accident from unexpected movement. ◀

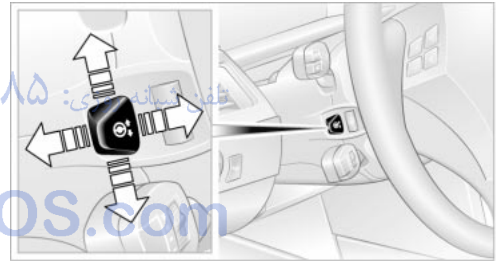

The steering wheel can be adjusted in any of four directions by pressing the appropriate end of the button.

Storing steering wheel positions, refer to Seat, mirror and steering wheel memory on page 38.

### Automatic steering wheel adjustment

In conjunction with seat, mirror and steering wheel memory.

The steering wheel automatically moves as high up and far forward as possible to ease driver entry and exit before then returning

to the standard position or stored memory setting.

This automatic feature is governed by the driver's door and the ignition lock.

### Steering wheel heater\*



The steering wheel heater operates when the ignition is on.

Press the button to activate or deactivate this system.

The indicator lamp within the button lights up when the steering wheel heater is in operation.

### Programming button function



Depending on your vehicle's equipment, you can assign an individual function to each of the two programmable function buttons\* on the steering wheel for each specific key. This feature then provides you with quick access to this function, allowing you to control it without undue distraction from road and traffic conditions.

Control Center, for principle details, refer to page 16:

1. Open the **i** menu
2. Select "Vehicle settings" and press the controller
3. Select "Steering wheel buttons" and press the controller

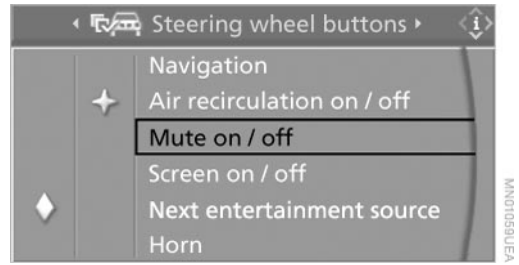

A list with different functions is displayed:

- ▷ "Navigation"  
Switching voice instructions on/off
- ▷ "Air recirculation on / off"  
In this mode, you can block the supply of outside air, refer to AUC Automatic recirculated-air control on page 91
- ▷ "Mute on / off"  
Mutes the audio sources
- ▷ "Screen on / off"  
Switches the Control Display on/off
- ▷ "Next entertainment source"  
Next audio source
- ▷ "Head-Up Display"  
Switches the Head-Up Display on/off
- ▷ "Horn"\*

4. Select the desired function and press the controller.

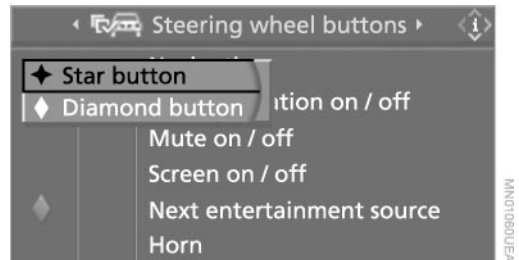

5. If appropriate, select a button and press the controller.

You can select the displayed function using the button.

# Transporting children safely

## The right place for children

### Children always in the rear

Accident research shows that the safest place for children in a vehicle is in the rear seat.

Older children should be tightly secured with a safety belt, after they have outgrown a booster seat that is appropriate for their age, height and weight.

 A child sitting in the rear seat and not properly restrained may place his or her head on or near the airbag, if so equipped. For example, a child – even though belted – may fall asleep with his or her head against the side airbag. It may be difficult for a driver to ensure that children in the rear seat will remain properly positioned at all times and do not place their heads on or near the side airbag. Therefore, we recommend that the rear side airbags, if provided, be deactivated if you plan to transport children in the rear seat. ◀

### Deactivating the rear seat side airbags

The rear seat side airbags may already have been deactivated by a BMW center. Labels in the rear door opening should indicate the status of your rear seat side airbags. If you are uncertain of their status, or wish to have the airbags activated or deactivated, please contact your BMW center.

### Child-restraint system in the rear

 Children under 13 years of age and children less than 5 ft/150 cm tall should always ride in the rear and the restraint systems should be secured with the vehicle's safety belts. ◀

Younger children should be secured in an appropriate forward-facing child-restraint system that has first been properly restrained. We strongly urge you to carefully read and comply with the instructions

for installation and use provided by the child restraint's manufacturer whenever you use such a device.

All rear sitting positions in your vehicle meet the recommendations of SAE J1819, an industry-recommended practice for securing child-restraint systems in motor vehicles.

### Exception for the front passenger seat

 Should it become necessary to use a child-restraint system on the front passenger seat, the airbags on the passenger's side must be deactivated. The passenger airbag indicator lamp above the interior rearview mirror must light up continuously. Otherwise, the front passenger airbags remain active and there is considerable risk of injury to children if the airbags are triggered, even with a child-restraint system. In this case, children should be seated in the rear and the system should be checked at your BMW center. ◀

 Never install a rearward-facing child-restraint system in the front passenger seat of this vehicle if the passenger airbag is not deactivated. If you do so, the child could be severely injured when the airbag is triggered.

Your vehicle is equipped with an airbag supplemental restraint system for the front passenger. Because the backrest on any rearward-facing child-restraint system – of the kind designed for infants under 1 year and 20 lbs./9 kg – would be within the airbag's deployment range, you should never mount such a system in the front passenger seat, since the impact of the airbag against the child restraint's backrest could lead to serious or fatal injuries. ◀

More information on automatic deactivation of the front passenger airbags, refer to page 83.

## Installing child-restraint systems

Before installing any child-restraint system or child seat, read the following:

 Observe the child-restraint system manufacturer's instructions for installation and use. Otherwise the degree of protection can be reduced. Following an accident, have all parts of the affected vehicle safety-belt system checked and, if necessary, replaced by a BMW center. ◀

Commercially-available child-restraint systems are designed to be secured with a lap belt or with the lap belt portion of a combination lap/shoulder belt. Improperly or inadequately installed restraint systems can increase the risk of injury to children. Always read and follow the instructions that come with the system.

### Child seat security

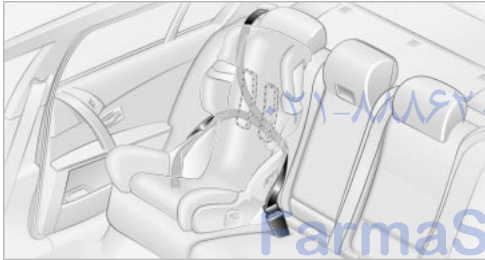

All of the rear belt retractors and the front passenger's safety belt can be locked for mounting and securing child-restraint systems.

Information regarding this is located near the buckle latch of each safety belt.

### To lock the safety belt

Pull the entire length of the belt from the belt retractor. Allow the reel to retract the belt somewhat and engage the buckle, then tighten the belt against the child-restraint system. The retraction mechanism is now locked.

### To unlock the safety belt

Release the buckle, remove the child-restraint system and allow the belt retractor to reel the belt completely in.

### Child-restraint system with tether strap

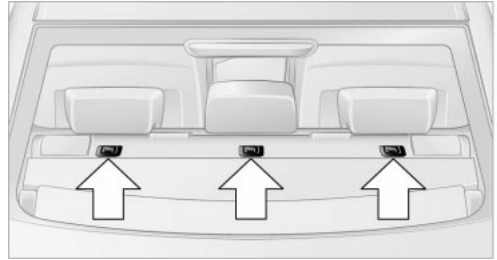

If you use a child-restraint system with a tether strap, three additional tether anchorage points have been provided, refer to the arrows in the illustration. Depending on the location selected for sitting in the rear passenger area, attach the tether strap to the corresponding anchorage point to secure the child-restraint system, as shown in the illustration below.

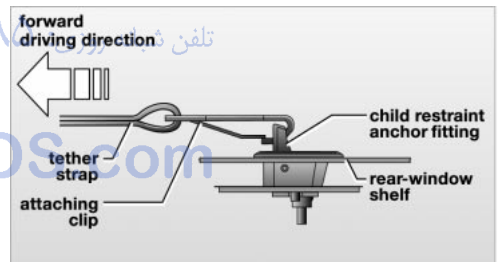

Each sitting position is fitted with a head restraint.

Outer seating positions:

Lift the head restraint and pass the tether strap between the head restraint and the seat back. It is recommended to readjust the head restraint into the lowest possible position.

Center seating position:

Pull the center armrest forward somewhat to guide the tether strap through the opening. Then reengage the center armrest.



 Adjust the tether strap according to the child-restraint manufacturer's instructions. ◀

### LATCH child-restraint fixing

LATCH: Lower Anchor and Tethers for Children.

The rear outer sitting positions are provided with anchors for a LATCH child-restraint fixing.

 To fit the LATCH child-restraint fixing, follow the operating and safety instructions of the manufacturer. ◀

### Access to anchorage points on the basic seat

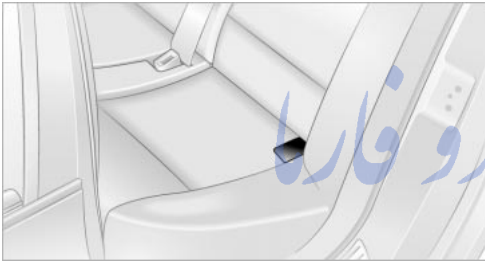

The illustrations show the left rear seat as an example. The outer anchorage points for the LATCH child-restraint fixing are identified by small flags.

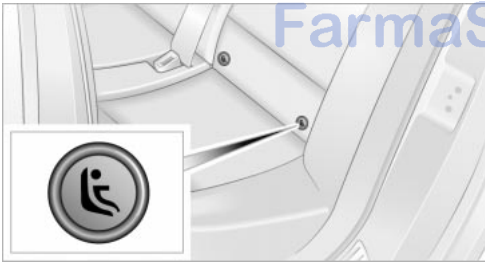

Canadian models only:  
The anchorage points for the LATCH child-restraint fixing are identified by buttons.

### Installation guide

The installation guide makes it easier to fit the LATCH child-restraint fixing and at the same time protects the surface of the seats.

 The installation guide is available at your BMW center. Always observe all instructions for installation and use provided by the child-restraint's manufacturer. ◀

1. Engage the center safety belt into the belt buckle
2. Pull the belt away from the area of the child-restraint fixing



3. Firmly press the installation guide into the gap between the upholstery on seat and backrest, continuing until the two funnel-shaped guides snap into place in the LATCH support braces in the seat.

Pull the installation guides to remove.

### Access to anchorage points on the rear seat with through-loading system

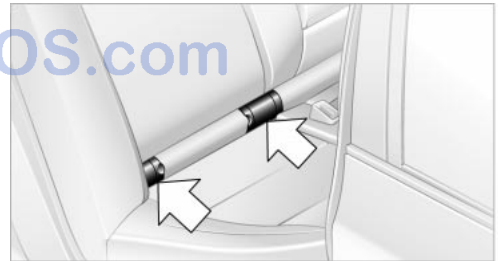

The illustration shows the right rear seat as an example.

The anchorage points for the LATCH child-restraint fixing are located behind the protective caps.

Before fitting the child-restraint fixing, remove the LATCH protective caps.

1. Engage the center safety belt into the belt buckle
2. Pull the belt away from the area of the child-restraint fixing.

## On journeys

 If side airbags are fitted in the rear, make sure that children do not lean out of the child's seat towards the door panels. Otherwise severe injuries can be caused if the side airbags are triggered. ◀

## Child safety locks for the rear doors

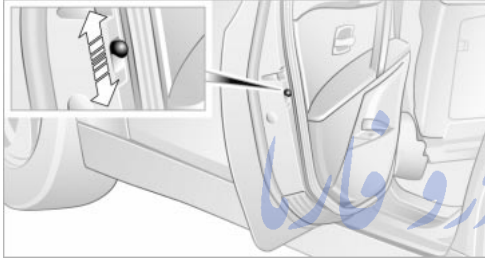

Slide down the safety lever on the rear doors:

The relevant door can now be opened from the outside only. تلفن شبانه روزی: ۰۲۱ ۸۸۸۶۲۰۸۵

FarmaSOS.com

## Ignition lock

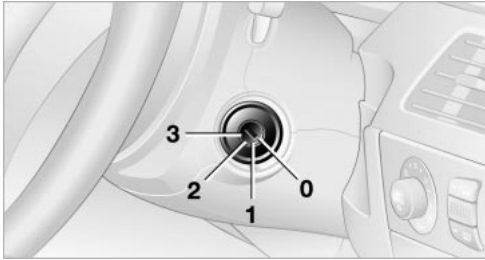

### 0 Steering locked

The key can only be inserted or removed in this position.

After removing the key, turn the steering wheel slightly until it locks.

 Vehicles with automatic transmission: only move the selector lever from position P with the engine running. To turn the key back to position 0 or to remove it, first place the selector lever in position P: Interlock. ◀

### 1 Steering unlocked

A slight steering wheel movement often makes it easier to turn the key from 0 to 1. Individual current consumers are ready for operation.

### 2 Ignition switched on

All vehicle systems are ready for operation.

### 3 Start engine

## Starting the engine

 Do not run the engine in closed rooms, as otherwise the inhaling of toxic exhaust gases can cause unconsciousness and death. The exhaust gases contain carbon monoxide, an odorless and colorless, but highly toxic gas. Never leave an unattended vehicle with the engine run-

ning, as such a vehicle represents a potential safety hazard. ◀

Do not allow the engine to warm up by leaving it running while the vehicle remains stationary. Instead, begin to drive immediately at a moderate engine speed.

When starting the engine, do not press the accelerator pedal.

 Your BMW is equipped with the convenience starting feature. Here, it is sufficient to turn the ignition key only briefly to position 3 'Start engine' and to let go of it right away. The system responds by automatically engaging the starter for a certain period and allowing it to run until the engine starts, after which it then disengages automatically. The automatic starting mode will not operate or will be canceled if the battery voltage is low. The engine can be started by jump-starting, refer to page 192. ◀

Press the accelerator pedal halfway down when starting if

- ▶ the engine fails to start on the first attempt, for instance, if it is very hot or cold
- ▶ the engine is started at very low temperatures, as of approx. +5 °F/-15 °C, at high altitudes over approx. 3,300 ft/1,000 m.

 Avoid frequent starting in quick succession or repeated start attempts in which the engine does not start. Otherwise, the fuel is not burned or inadequately burned and there is a danger of overheating and damaging the catalytic converter. ◀

### Manual transmission

1. Apply the handbrake
2. Gearshift lever in idle position
3. Press the clutch pedal
4. Start the engine.

 Before leaving the vehicle with the engine running, place the gearshift

lever in idle position and apply the handbrake.

Never leave an unattended vehicle with the engine running, as such a vehicle represents a potential safety hazard. ◀

### Automatic transmission

1. Press the brake pedal
2. Place the selector lever in position P or N
3. Start the engine.



To prevent the vehicle from rolling, always select position P or N and engage the handbrake before leaving the vehicle with the engine running. Never leave an unattended vehicle with the engine running, as such a vehicle represents a potential safety hazard. ◀

### Sequential manual transmission SMG

1. Press the brake pedal
2. Place the selector lever in the idle position N
3. Start the engine.



If the engine does not start, engage the last gear selected, refer to Display in the instrument cluster, and return the selector lever to the idle position N. ◀



Before leaving the vehicle with the engine running, place the selector lever in position N and apply the handbrake.

Never leave an unattended vehicle with the engine running, as such a vehicle represents a potential safety hazard. ◀

### Switching off engine



Do not remove the ignition key while the vehicle is rolling, as otherwise the steering wheel lock would engage while steering.

When leaving the vehicle, always remove the ignition key and lock the steering.

When parking on downward inclines, apply the handbrake. ◀

### Manual transmission

Turn the ignition key to position 1 or 0.

### Automatic transmission

1. Engage selector-lever position P
2. Turn the ignition key to position 1 or 0.

### Sequential manual transmission SMG

If the selector lever is in position R or in the sequential mode and you turn the ignition key to position 1 or 0, the gear remains engaged automatically.

If the selector lever is in the idle position N and you turn the ignition key to position 1 or 0, an acoustic signal and the flashing gear indicator in the display reminds you that the vehicle is not secured against rolling away.

The warning stops sounding after approx. 9 seconds.



When parking on downward inclines, apply the handbrake. Engaging a gear is not sufficient to secure the vehicle from rolling away under certain circumstances. ◀

### Handbrake

The handbrake is primarily intended to prevent the vehicle from rolling while parked; it brakes the rear wheels.

### Indicator lamp



The indicator lamp lights up with the handbrake applied, and an acoustic signal also sounds when starting off.



Indicator lamp for Canadian models.

### Applying

The lever locks into place automatically; the indicator lamp in the instrument cluster lights up in ignition key position 2.



VWDC120AM

## Manual transmission



MM029543AM

### Releasing

Pull slightly upwards, press the button and lower the lever.

**!** If exceptional circumstances should make it necessary to engage the handbrake while the vehicle is in motion, do not pull it too strongly. In doing so, continuously press the button of the handbrake lever.

Strong application of the handbrake can lead to overbraking of the rear axle and associated 'fishtailing' of the vehicle rear end.

The brake lamps do not light up when the handbrake is applied.

Vehicles with manual or SMG transmission: When parking on inclines, apply the handbrake, as under certain circumstances even engaging the first or reverse gear might not secure the vehicle against moving.

Vehicles with automatic transmission: Place selector lever in position P. ◀

**▶** To prevent corrosion and one-sided braking action, occasionally apply the handbrake lightly when the vehicle is slowly coming to a standstill if the traffic conditions are suitable. ◀

**!** While shifting gear in the 5th/6th gear level, make sure that you press the gearshift lever to the right to prevent inadvertently selecting a gear in the 3rd/4th gear level. On inclines, do not hold the vehicle with the clutch; use the handbrake. Holding with the clutch causes high clutch wear. ◀

### Reverse gear

Select R only when the vehicle is completely stopped. When pressing the gearshift lever to the left, overcome some resistance.

The backup lamps automatically come on in ignition key position 2.

## Sequential manual transmission SMG\*

### The concept

The Sequential manual transmission SMG is an automated manual transmission in which an electro-hydraulic system handles the clutching and gear changes.

You operate the SMG using the selector lever in the center console and two shift paddles on the steering wheel.

It provides you with the following functions:

- ▷ Sequential mode: manual mode
- ▷ Drive mode: automatic mode
- ▷ Choice between two drive programs: Normal, Sport, refer to page 54
- ▷ Operating reliability with protection against incorrect gearshifts

- ▷ Automatic upshifts and downshifts in the Drive mode
- ▷ Automatic downshifts with minimum engine speed
- ▷ Kickdown function in the Drive mode
- ▷ Acceleration assistant, refer to page 54.

## Selector-lever positions



The current selector-lever position is displayed on the center console.

R: Reverse gear

N: Neutral, idle

Position for forward driving with one-touch functions:

Sequential mode

+: manual upshifts

–: manual downshifts

D: Drive mode.

The SMG is operational in ignition key position 2.

 Idle is automatically engaged if the driver's door is opened with the engine running and neither pedals, shift paddles nor the selector lever are operated.

This is signaled by an acoustic signal and the flashing gear indicator. The gear display N appears in the instrument cluster. A driving position can only be selected with the driver's door closed.

When the vehicle is unlocked, a buzzing sound in the area of the transmission signals that the system is ready for operation. ◀

## Shiftlock

For your safety a driving position can only be engaged from the selector lever position N with the vehicle stationary with the brake pedal depressed.

## Observe the following when driving

 Start off quickly on slopes. Do not hold the vehicle on a hill by pressing the accelerator, but apply the handbrake instead. Otherwise overheating can occur in the area of the transmission. ◀

## R Reverse

Select R only when the vehicle is completely stopped.

## N Neutral: idle

Engage prior to every engine start, refer also to page 50.

## Sequential mode

After every engine start, as soon as the selector lever is brought into a forward gear position and the brake is pressed, the sequential mode is activated.

The gear is changed using the shift paddles or selector lever.

Driving off is also possible in second gear, e.g. when there is snow on the roadway.

## D Drive mode

In the Drive mode, all forward gears are shifted automatically.

To switch from the sequential to Drive mode: briefly press the selector lever to the right towards D.

For rapid acceleration, e.g. overtaking, press the accelerator pedal as far down as it will go – kickdown.

Kickdown:

The kickdown mode provides maximum acceleration.

Press the accelerator pedal beyond the full-throttle resistance point.

To return to the sequential mode: briefly press the selector lever back to the right

towards D or change the current gear using the shift paddles or selector lever.

## Gear changes

### Using selector lever

- ▷ To shift up, briefly press the selector lever towards +
- ▷ To shift down, briefly press towards –.

### Using shift paddles on steering wheel

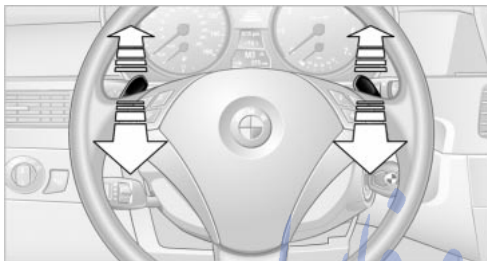

- ▷ To shift up, pull one of the shift paddles
- ▷ To shift down, press.

You accelerate from higher gears, e.g. when overtaking, by shifting down manually.

In the following situations, the SMG in the sequential mode assists you:

- ▷ Upshifts and downshifts are executed only when they will result in a plausible combination of engine and vehicle speed; thus, for example, a downshift that would cause the engine to overrev will not be executed by the system
- ▷ When the vehicle is stopped, the transmission automatically downshifts into first gear
- ▷ Shortly before dropping below a gear-dependent minimum speed, the transmission downshifts automatically even without your intervention.

## Display in the instrument cluster

### Gear display

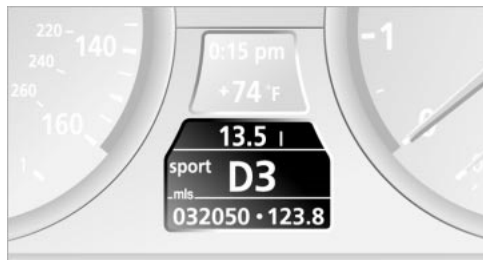

R N 1 2 3 4 5 6

D1 D2 D3 D4 D5 D6

The gear currently selected, the selected shifting mode and, if applicable, malfunctions are displayed in the instrument cluster.

### Malfunctions

#### Indicator lamp



If the indicator lamp lights up, a malfunction has occurred in the transmission system.

While it will remain still possible to move the selector lever to any desired position, the transmission will revert to operation in its default mode with only a limited number of forward gears.

If this happens, avoid extreme engine loads and consult the nearest BMW center.

### Warning tone

In case of overheating in the area of the transmission, an acoustic signal indicates that you should stop or start off quickly if possible so that the system can cool down again.

Information on jump-starting and towing begins on page 192.

## Dynamic Driving Control

With Dynamic Driving Control, you can choose between a standard and a sport program.

### Sport program

- ▷ The engine responds more spontaneously to accelerator pedal movements
- ▷ The steering becomes more direct and provides even better road contact.

In addition, with SMG and an automatic transmission:

- ▷ The shifting times are shorter
- ▷ The engine speed range is used optimally in the Drive mode.



### Activating the Sport program

In ignition key position 2.

Press the SPORT button.

The LED in the button lights up.

- ▷ With an automatic transmission: Activating the Dynamic Driving Control activates the Sport program of the automatic transmission. This makes moving the selector lever from D to M/S unnecessary. ◀

### Deactivating the Sport program

Press the SPORT button again.

The LED in the button goes out.

### Acceleration assistant with SMG

The acceleration assistant enables optimized vehicle acceleration at racing car level on road surfaces with good adhesion.

**!** Do not use the acceleration assistant too often, as otherwise components will wear prematurely. ◀

1. Activate the Sport program
2. Press the DSC button, refer to page 79, for longer than three seconds
3. Press the accelerator pedal down fully – kickdown. The ideal starting-off engine speed is set.

- ▷ To maintain driving stability, drive with the DSC on whenever possible. ◀

Information on jump-starting and towing begins on page 192.

## Automatic transmission with Steptronic\*

While you can drive as with any conventional automatic transmission, you also enjoy the option of shifting manually, refer to page 55.

If you move the selector lever from position D to the left into gearshift gate M/S, this activates the sports-style shift programs of the automatic transmission. As soon as you move the selector lever slightly towards + or –, the Steptronic shifts gear and manual operation is activated. If you wish to use the automatic function again, move the selector lever to the right into position D.

### Selector-lever positions

P R N D M/S + –

### Possible displays

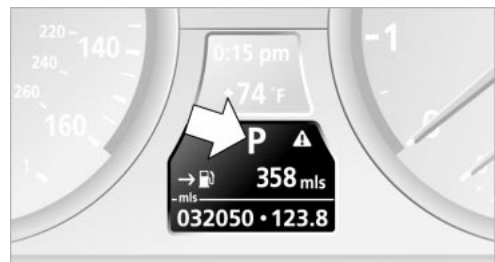

P R N D DS M1 M2 M3 M4 M5 M6



## Changing the selector-lever positions



An interlock prevents inadvertent gear-shifts into selector-lever positions R and P. To cancel the interlock, press the button on the front of the selector lever knob, refer to arrow.

 Press the brake pedal before shifting out of P or N; the shift command will not be executed unless the brake is applied: Shiftlock.

To prevent the vehicle from creeping after you select a driving position, maintain pressure on the brake pedal until you are ready to start. ◀

 To prevent the vehicle from rolling, always select position P and engage the handbrake before leaving the vehicle with the engine running.

Never leave an unattended vehicle with the engine running, as such a vehicle represents a potential safety hazard. ◀

### P Parking

Select P only when the vehicle is completely stopped. The rear wheels are blocked.

### R Reverse

Select R only when the vehicle is completely stopped.

### N Neutral

Select N only if your journey is interrupted for a long period.

### D Drive – automatic driving position

Position for normal vehicle operation. All forward gears are available.

Under normal operating conditions, fuel consumption is lowest when driving in position D.

### Kickdown

A kickdown provides you with maximum acceleration and the maximum road speed in position D.

Press the accelerator pedal beyond the full-throttle resistance point.

### M/S manual operation and Sport program

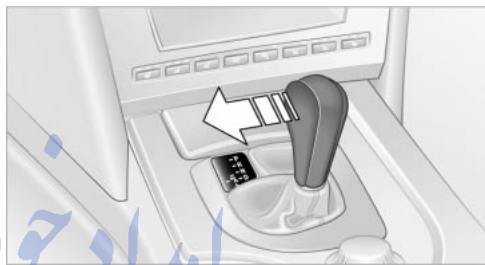

Shifting from D into M/S activates the Sport program and this is indicated with DS in the gear display. This position is recommended if a performance-oriented driving style is desired. تلفن

The first time the selector lever is even slightly touched, the automatic transmission shifts from the Sport program into manual operation.

If you start to move the selector lever towards +, the transmission shifts upwards; moving it towards – it shifts downwards. The gear display shows M1 through M6.

Upshifts and downshifts are executed only when they will result in a plausible combination of engine and vehicle speed; thus, for example, a downshift that would cause the engine to overrev will not be executed by the system. The selected gear appears briefly in the instrument cluster, followed by the current gear.

 To obtain maximum acceleration, for passing maneuvers, etc., during operation in the manual mode, use the kickdown or downshift manually. ◀

Shifting from M/S to the selector-lever positions P, R and N is only possible by going through D.

## Malfunctions

### Indicator lamp



If the indicator lamp lights up, a malfunction has occurred in the transmission system.

While it will remain still possible to move the selector lever to any desired position, the transmission will revert to operation in its default mode with only a limited number of forward gears.

If this happens, avoid extreme engine loads and consult the nearest BMW center.

Information on jump-starting and towing begins on page 192.

## Turn signal indicators/ headlamp flasher

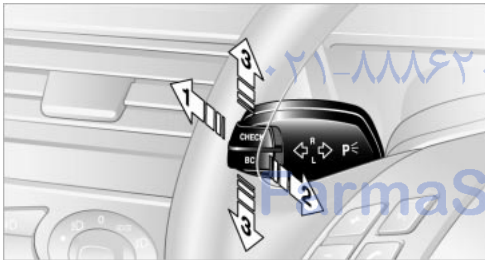

- 1 High beams: blue indicator lamp
- 2 Headlamp flasher: blue indicator lamp
- 3 Turn signal indicators: the green indicator lamp flashes, accompanied by a periodic clicking from the turn signal indicator relay

### Using turn signal indicators

Move the lever beyond the resistance point. It then returns to the center position when released. Press the lever as far as the resistance point to switch off the turn signal indicators.



If the flashing indicator lamp and the clicking from the relay are both faster than normal, this indicates that one of the turn signal indicator bulbs is defective. ◀

### Signaling briefly

Press the lever up to but not beyond the resistance point. It then returns to the center position when released.

### Triple turn signal activation

Press the lever as far as the resistance point; the turn signal indicators flash three times. You can activate or deactivate this function.

Control Center, for principle details, refer to page 16:

1. Open the **i** menu
2. Select "Vehicle settings" and press the controller
3. Select "Lighting" and press the controller

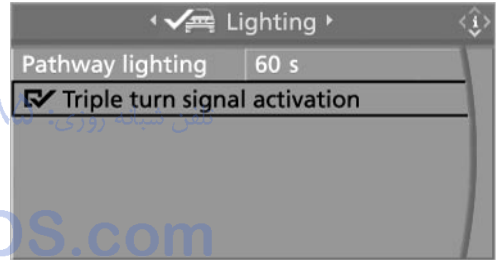

4. Select "Triple turn signal activation" and press the controller.  is displayed when triple turn signal is activated.

## Wiper system

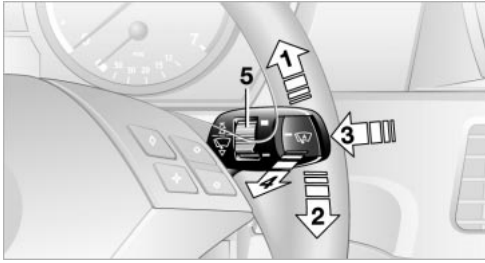

- 1 Normal wiper speed: briefly press once. The system automatically reverts to operation in the intermittent mode whenever the vehicle stops. Fast wiper speed: briefly press twice or press beyond the resistance point. The system automatically reverts to operation in the standard wiper mode whenever the vehicle stops
  - 2 To switch off wipers or for brief wipe
  - 3 To activate/deactivate rain sensor
  - 4 To clean windshield and headlamps
  - 5 To adjust rain sensor sensitivity level
- The lever automatically returns to its initial position when released.

### Cleaning the windshield and headlamps\*

The system sprays washer fluid against the windshield and activates the wipers for a brief period.

When the vehicle lighting system is switched on, the headlamps are also cleaned at regular and appropriate intervals.

 Do not use the washers if there is any danger that the fluid will freeze on the windshield. If you do so, your vision could be obscured. To avoid freezing, use a washer fluid antifreeze, refer to Washer fluid.

Avoid activating the washer when the reservoir is empty, as damage to the pump could result. ◀

## Windshield washer nozzles

The windshield washer nozzles are automatically heated in ignition key position 2.

## Rain sensor

The rain sensor controls windshield wiper operation depending on the amount of rain. The rain sensor is located on the windshield, directly in front of the interior rear-view mirror.

### Activating the rain sensor

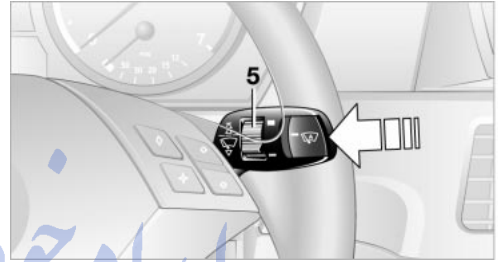

As of ignition key position 1, briefly press the button. The indicator lamp in the button lights up. The wipers will always respond by completing at least one sweep of the windshield.

تلفن شبانه روزی: ۰۲۱-۸۸۶۲۰۸۵

### Adjusting rain sensor sensitivity level

Turn the serrated dial 5.

### Deactivating the rain sensor

Briefly press the button again. The indicator lamp goes out.

The rain sensor is automatically deactivated when you switch off the ignition.

 Deactivate the rain sensor when passing through an automatic car wash. Failure to do so could result in damage caused by undesired wiper activation. ◀

## Washer fluid

 Washer fluid antifreeze is flammable. Always keep it well away from sparks and open flames, and store it in tightly closed containers well out of the reach of

children. Always observe the instructions for use provided on the containers. ◀

### Washer fluid reservoir



Capacity: approx. 3.2 US quarts/3 liters for the windshield washer system or approx. 5.3 US quarts/5 liters in conjunction with headlamp washer system.

Fill with water and – if required – with a washer antifreeze, according to manufacturer's recommendations.

 In order to keep to the mixture ratio, mix the washer fluid before filling. ◀

## Cruise control\*

### The concept

The cruise control is available for use at speeds of approx. 20 mph/30 km/h and higher. The vehicle maintains and stores the speed that you set using the lever mounted on the steering column.

 Do not use the cruise control when driving on winding roads, in heavy traffic or in poor road conditions – e.g. snow, rain, ice, loose road surface – that do not permit a constant speed. ◀

### One lever for all functions

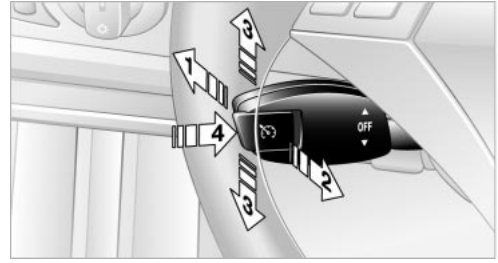

#### 1 Maintaining and storing speed, accelerating

Press the lever up to the resistance point: The current speed is maintained and stored. The display 1 in the speedometer indicates this regulated speed, refer to page 59. Every time you briefly press the lever, the vehicle's speed increases by roughly 1 mph/1 km/h.

Press the lever for longer:

The vehicle accelerates without pressure on the accelerator pedal. The system maintains and stores your current speed as soon as you release the lever.

Press the lever beyond the resistance point:

Speed is increased by 5 mph/10 km/h.

The vehicle may accelerate beyond the regulated speed on steep downhill stretches where the engine's braking effect alone may not be sufficient to slow the vehicle. Speed can drop on uphill grades if the engine output is insufficient.

#### 2 Maintaining and storing speed, decelerating

Pull the lever up to the resistance point: Functions same as 1, only the vehicle speed is reduced.

#### 3 Interrupting cruise control

With the cruise control active, briefly press the lever up or down.

In addition, cruise control is interrupted automatically

▷ when you apply pressure to the brake pedal

- ▷ when you press the clutch or engage position N of the automatic transmission
- ▷ when the DSC system is in active operation.

## 4 Recalling stored speed

Press button 4 briefly: the vehicle accelerates to and maintains the last speed stored.

## Deactivating system

When the ignition is switched off, the system is deactivated and the stored speed is deleted.

## Displays in the instrument cluster



- 1 Stored desired speed display
- 2 Digital speed display.  
Appears briefly when you select your desired speed.

## Active cruise control\*

### The concept

With active cruise control you can select a desired speed which is not only automatically maintained when driving on open roadways, but also varied to maintain a selected distance setting as slower traffic is encountered.

Active cruise control is a technological advance over the familiar cruise control and is a welcome relief from the constant adjustment of speed that can accompany driving in traffic on freeways or other high-speed thoroughfares. Especially on longer trips, the system can reduce fatigue and tension, while increasing your enjoyment of

driving. Please use it safely and responsibly.

In addition to holding a steady cruising speed, if you do encounter slower vehicles ahead, active cruise control will, within the scope of given possibilities, adjust your vehicle's speed automatically so that you can flow with the traffic without frequent intervention by the driver. If, for example, while cruising at the selected speed, you begin to approach a slower vehicle ahead of you in the same lane, the system will reduce your vehicle's speed to the same as that of the vehicle ahead to maintain your selected distance setting between your vehicle and the vehicle ahead. There are four settings for distance, which is additionally speed-dependent. Based on your selected distance setting, the system automatically decreases the throttle setting and lightly applies the brakes if necessary. The vehicle brake lamps will automatically illuminate to signal a following driver to take action. In addition, it may be necessary for the vehicle to downshift to maintain the distance setting selected. If the vehicle ahead speeds up or when the lane ahead becomes clear, your vehicle will accelerate to the speed you have selected by increasing the throttle setting and shifting gears as needed.

 Active cruise control is not and must not be used as a collision avoidance/warning system. ◀

 Since this active cruise control system is a new technology and operates differently from conventional cruise control systems which you may be accustomed, you are strongly urged to read all of the pages relating to this system before use. Pay special attention to the information contained in the Things to know about active cruise control section in this manual beginning on page 62. ◀

## Displays in the instrument cluster



- 1 Stored desired speed display
- 2 Detected vehicle display. Lights up when vehicle driving ahead is detected
- 3 Selected distance to vehicle driving ahead
- 4 Digital speed display. Appears briefly when you select your desired speed.



The system is activated. The display appears as soon as you activate the system and no vehicle is detected driving ahead.



Vehicle detected. The display 2 lights up yellow when a vehicle is detected driving ahead.



The system requests you to intervene by braking or with an evasive maneuver. The display 2 flashes red and a signal sounds. The active cruise control cannot automatically restore the distance to the vehicle driving ahead. You will find more detailed information on page 64.



Automatic intervention by ABS or DSC, or you actuate the handbrake while driving. The display 2 flashes yellow. The active cruise control now only intervenes by braking.

## Operating the active cruise control

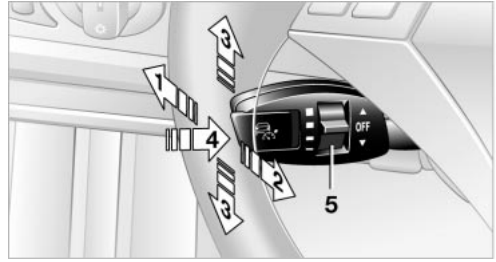

- 1 Activate system, store and increase desired speed
- 2 Activate system, store and decrease desired speed
- 3 Deactivate system
- 4 With system deactivated: Briefly press the button to recall the stored speed and distance  
With system activated: Increase desired speed by 5 mph/ 10 km/h with each press of the button
- 5 Select distance to vehicle driving ahead. You can choose from four available distance settings. You will find more detailed information on page 62.

**!** Adjust your desired speed to the traffic conditions and remain ready to brake at all times. Great differences in speed to the vehicles driving ahead, e.g. when quickly approaching a truck or when another vehicle swerves into your lane, cannot be compensated for by the system. ◀

### Activate system



From approx. 20 mph/30 km/h you can activate the system by pressing the lever forward or pulling it back:

The current driving speed is stored as a desired speed and briefly displayed in the instrument cluster, see below.

## 1 Desired speed store and increase



Press the lever forward:

The system adopts and stores your current speed as a desired speed. The speedometer indicates this speed.

Subsequently pressing forward increases the desired speed to the next 5-mile place/10 km/h.

Each time the lever is pressed forward again, the desired speed is increased by another 5 mph/10 km/h until a maximum of 110 mph/180 km/h is reached. The speed then displayed is stored and reached on a clear road.

 If the system cannot be activated, the display ACC --- mph/km/h briefly appears in the instrument cluster. The system may have been automatically deactivated, refer to Deactivate system, or a malfunction has occurred.

To call up Check Control messages, refer to page 68. ◀

## 2 Desired speed store and decrease

Pull back the lever:

The current driving speed is rounded off to the next 5-mile place/10 km/h, displayed and stored.

Each time the lever is pulled back again, the desired speed is decreased by another 5 mph/10 km/h until the minimum speed of 20 mph/30 km/h is reached. The speed then displayed is stored and reached on a clear road.

## 3 Deactivate system

Press the lever up or down while the system is active. The displays in the instrument cluster disappear. You can use the system again as required.

In addition, the system is deactivated automatically:

- ▷ When you apply pressure to the brake pedal
- ▷ When you select the automatic transmission's/SMG's neutral range N
- ▷ With the manual transmission idling
- ▷ When you deactivate the DSC Dynamic Stability Control
- ▷ When you actuate the parking brake during driving
- ▷ When the system reduces the speed to below 20 mph/30 km/h due to a traffic situation.

 The system deactivates automatically when the speed is set to below 20 mph/30 km/h. A gong sounds and a message appears on the Control Display. The active intervention of the driver is required. ◀

When you switch off the ignition, the stored desired speed is deleted.

## 4 Resume to stored desired speed and distance setting

Press button 4:

The displays appear in the instrument cluster. The system is reactivated and uses the last stored desired speed and distance setting.

## 4 Fine adjustment of desired speed

In the activated state, the desired speed increases by 1 mph/1 km/h each time button 4 is pressed briefly.

## 5 Select distance

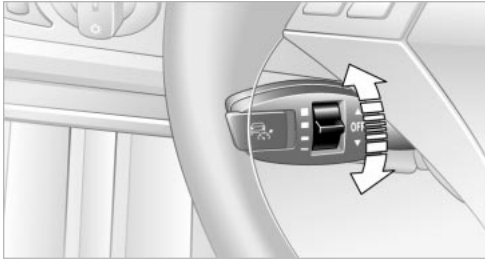

You can choose from four distance steps.

- ▷ Rotary switch downward: Decrease distance.
- ▷ Rotary switch upward: Increase distance.

The selected distance is displayed in the instrument cluster.



Distance 1



Distance 2



Distance 3

This distance is always set when the system is used for the first time after starting the engine.



Distance 4



Use good judgment to select the appropriate following distance given road conditions, traffic, applicable laws and driving recommendations for safe following distance. ◀

## Things to know about active cruise control

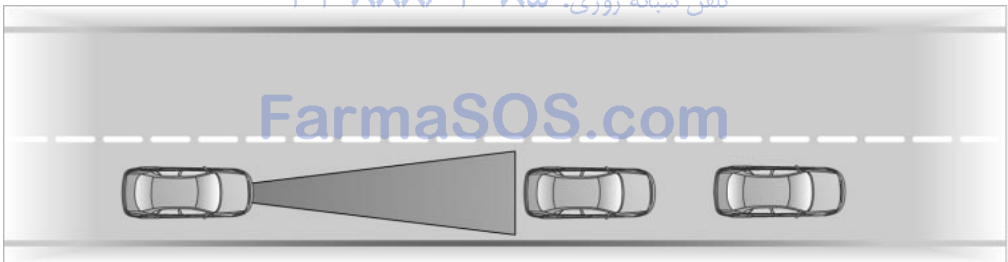

As with conventional cruise control systems, active cruise control in no way diminishes or substitutes for the driver's own personal responsibility, alertness and awareness in adjusting speed, braking or otherwise controlling the vehicle. The driver should decide when to use the system on the basis of road, traffic, visibility, and weather conditions. Active cruise control is intended for use on highway-type roadways where traffic is moving relatively smoothly. Do not use this system in city driving; heavy traffic such as during

rush hour; on curvy, winding roads, slippery roads or roads with sharp curves such as highway off-ramps; during inclement weather such as snow, strong rain or fog; or when entering interchanges, service/parking areas or toll booths. It is also important to regulate your vehicle's speed and distance setting within applicable legal limits. Always be ready to take action or apply the brakes if necessary, especially when the system is actively following a vehicle in front of you. ◀



**!** Always remember that the range and ability of the system does have physical limitations. It will not apply the brakes or decelerate your vehicle when there is a slow-moving vehicle, stopped vehicle or stationary object ahead of you, as for example, at a traffic light or a parked vehicle. Also, the system does not react to oncoming traffic, pedestrians or other type of potential traffic such as a rider on horseback. It is also possible that the system may not detect smaller moving objects such as motorcycles or bicycles. Be especially alert when encountering any of these situations as the system will neither automatically brake, nor provide a warning to you. Also, be aware that every decrease in the distance setting allows your vehicle to come closer to a vehicle in front of you and requires a heightened amount of alertness. ◀

If while your vehicle is actively following a vehicle in front of you and the vehicle ahead speeds up or the lane ahead becomes clear, then your vehicle will accelerate to the speed you have selected. Be aware that changing to a clear, unobstructed lane will also result in your vehicle accelerating.

**!** Be certain to deactivate the system when you pull into an exit lane for a highway off-ramp. ◀

Also, vehicles traveling in a staggered manner on a highway may cause a delay in the system's reaction to a vehicle in front of you or may cause the system to react to a vehicle actually in the lane next to you. Always be ready to take action or apply the brakes if necessary.

Active cruise control can only decelerate the vehicle to approx. 20 mph/30 km/h. If the system reduces vehicle speed below 20 mph/30 km/h or if DSC/ABS is engaged while driving, the system will automatically deactivate.

**!** Remember, the system cannot stop your vehicle. In addition, the system is deactivated whenever the driver applies the vehicle brakes, shifts the transmission from drive/D to neutral/N, or deactivates

DSC. After any deactivation, the system will no longer automatically activate the vehicle brakes, which means the driver must intervene and resume manual braking. You should then reactivate the system only when you are fully aware of the prior speed and distance settings. ◀

Active cruise control may brake when you reduce the stored desired speed; however, the driver must constantly monitor traffic and intervene if necessary.

When you switch off the engine or ignition, active cruise control is fully switched off, too, and any settings you have selected are canceled.

### Behavior in curves

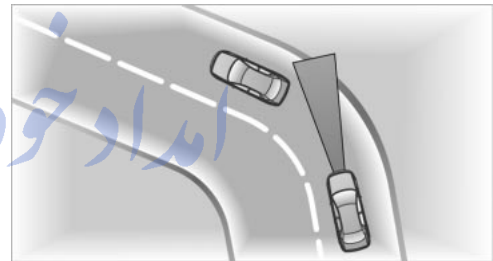

MV01486CMA

Because of the limited range of the system, it is possible that in curves or on the peaks and valleys of hilly roads, a vehicle ahead may be recognized late, or not at all. Therefore, it is up to the driver to select a speed that is prudent in view of the curves and terrain of the roadway.



MV02292CMA

In approaching a curve, it is possible that active cruise control would react briefly to a vehicle in the adjacent lane. In addition, the system can sense if your vehicle is in a curve and may not accelerate. If your vehicle decelerates in either case, you can

choose to overcome the deceleration by briefly pressing the accelerator pedal.

### Driver interventions



Anytime the driver presses down on the accelerator pedal, any automatic braking action by the system is interrupted until the pedal is fully released. After doing this, release the accelerator and the system again controls your cruising speed and distance setting. While driving with activated system, resting your foot on the accelerator pedal will cause the system not to brake even if necessary. Be certain that floor mats or other objects on the vehicle floor do not interfere with movement of the accelerator pedal. ◀



While active cruise control is capable of braking your vehicle automatically when you approach a slower vehicle ahead, it is important to be aware that the ability of the system to apply the brakes is also limited, if you are driving down a steep grade or when you reduce your desired speed sharply. The system cannot stop your vehicle. It uses only a portion of braking system capacity and does not utilize the full capacity of the vehicle braking system. Therefore, the system cannot decrease your speed for large differences in speed between your vehicle and the vehicle ahead. Examples: during emergency braking, when you approach a vehicle traveling at a much lower speed than your own speed such as approaching a toll booth or when a much slower vehicle cuts in front of you at close range. ◀



Whenever active cruise control recognizes a situation that requires driver braking because the system capacity has been reached or has been exceeded,

the system alerts the driver by flashing this symbol in the instrument cluster and sounding a signal.

### Swerving vehicles

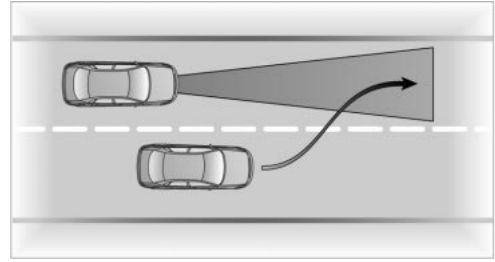

When a vehicle moves from an adjacent lane into your lane, active cruise control will not recognize this vehicle until it is fully in your lane ahead of your vehicle.

### Malfunctions



If there is a malfunction, the indicator lamp symbol is displayed in the instrument cluster. Please note any supplementary information that appears on the Control Display.

The build-up of foreign material, e.g., snow, ice, dirt, road debris, etc., can lead to reduced detection performance of active cruise control. You should check the sensor under the front bumper and clean it as necessary prior to driving your vehicle. If the sensor becomes covered by foreign material or has a malfunction, it is possible that the sensor will no longer be able to detect vehicles in front of you. After the system recognizes that the sensor is no longer functional, a message is displayed on the Control Display and an acoustic signal is emitted.

# Everything under control

## Odometer, outside temperature display, clock



When the ignition is switched off you can briefly activate the time, outside temperature and odometer displays by pressing the button at the lower left of the instrument cluster.

### 1 Outside temperature display, clock, date

The outside temperature and the time are display as of ignition key position 1.

You can change the measurement unit °C/°F in the **i** menu, refer to Measurement units on page 74.

To call up the date:

Briefly press the Check button on the turn indicator lever, refer to page 69.

Setting the time and date, refer to page 74.

### Ice warning

A warning signal sounds when the outside temperature falls to roughly +37.5 °F/+3 °C; this is accompanied by a message.

 Please bear in mind that the ice warning does nothing to alter the fact that black ice may be present on roads at temperatures higher than +37.5 °F/+3 °C, e.g. on bridges and shaded roads. ◀

## 2 Odometer and trip odometer

To set the trip odometer to zero: Press the button at the lower left of the instrument cluster.

## Tachometer



The white-striped advance warning field, arrow 1, changes depending on the engine temperature. The segments disappear in sequence as the engine warms to its normal operating temperature.

Avoid allowing the engine speed to rise as far as the advance warning field whenever possible.

Engine speeds in the red warning field, arrow 2, must be avoided.

In this range, the fuel supply is interrupted to protect the engine.

## Energy Control/Current fuel consumption



Displays the current fuel consumption. This allows you to see whether your current driving style is conducive to fuel economy with minimum exhaust emissions.

## Fuel gauge



After the reserve quantity has been reached, a message appears for a short time on the Control Display; the range is shown in the computer. Below a range of approx. 30 miles/50 km, the message remains on the Control Display, and the range is displayed.

Fuel tank capacity: approx. 18.5 gallons/ 70 liters, of which approx. 2.1 gallons/ 8 liters reserve. You can find information on Refueling on page 168.

If the tilt of the vehicle varies for a longer period, when you are driving in mountainous areas, for example, the indicator may fluctuate slightly.



Refuel well before the tank is empty, as otherwise engine functions will not be ensured and damage can occur if you drive down to the last drop. ◀

## Service requirement display and display of legally prescribed inspections

### In the instrument cluster



The remaining distance to be driven, the date for the next maintenance as well as the date entered for the state emission or vehicle inspection are displayed briefly as of ignition key position 2, if the date is imminent.

▶ Your Service Advisor will determine your vehicle's current service requirements by reading out the data stored in the vehicle key. ◀

### On the Control Display

You can view additional information on service and maintenance procedures using the Control Center.

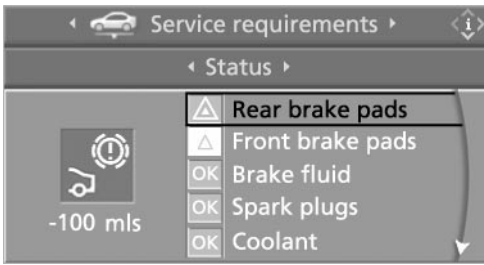

Control Center, for principle details, refer to page 16:

1. Open the **i** menu
2. Select "Service" and press the controller
3. Select "Service requirements" and press the controller
4. Select "Status" and press the controller.



The display shows a list of selected service and maintenance procedures, as well as legally prescribed official inspections.

### Symbols

-  The service deadline has already passed.
-  The deadline for service or an official inspection is approaching. Please contact your BMW center for an appointment.
-  No service is currently required. If you desire, certain maintenance operations can be carried out at the next service. You can request more detailed information on every entry. Select the entry and press the controller.

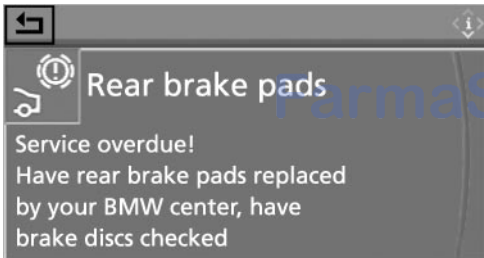

To exit the menu:  
Select  and press the controller

### Entering dates for state emission and vehicle inspections

-  Make sure the date in the Control Center is always set correctly, refer to page 74, as otherwise the effectiveness of Condition Based Service CBS is not ensured. ◀

Control Center, for principle details, refer to page 16:

1. Open the **i** menu
2. Select "Service" and press the controller
3. Select "Service requirements" and press the controller
4. "Select Status" and press the controller

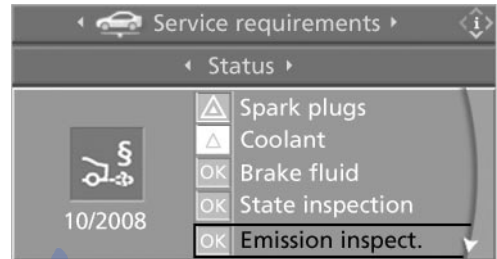

5. Select "Emission inspect." or "State inspection" and press the controller
6. Select "Set service date" and press the controller. The month is highlighted



7. Turn the controller to make the adjustment
8. Press the controller to accept the setting. The year is highlighted
9. Turn the controller to make the adjustment
10. Press the controller to apply the setting. The date entry is stored.

To exit the menu:  
Select  and press the controller

## Check Control

### Display of a message

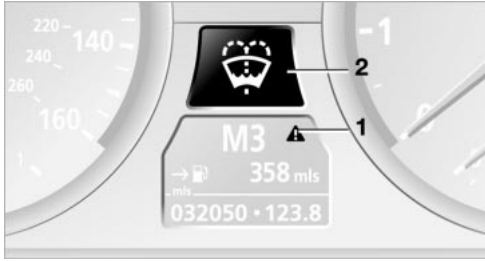

- 1 means that a Check Control message is present
- 2 Information and malfunction reports on systems are indicated by an illuminated indicator or warning lamp symbol



At the same time, a gong sounds and a text message appears on the Control Display. Messages are assigned one of two priority ratings:

#### Priority 1

These messages and malfunction reports are signaled by a gong. If a number of malfunctions occur simultaneously, they are displayed in succession. These messages cannot be deleted, and they remain on the display until the problem is corrected. Supplementary information can also appear on the Control Display.

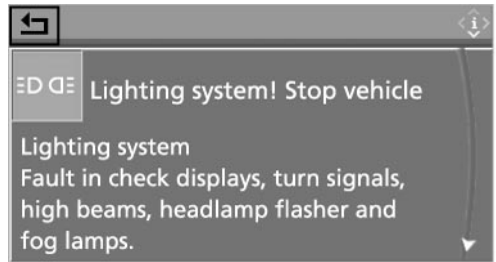

These supplementary messages are intended to assist you in assessing the severity of malfunctions; they provide you with the information you need to decide on the best way to respond.

To exit the menu:  
Select and press the controller.

#### Priority 2

These status messages and malfunction reports are indicated by the gong and displayed for approx. 20 seconds.

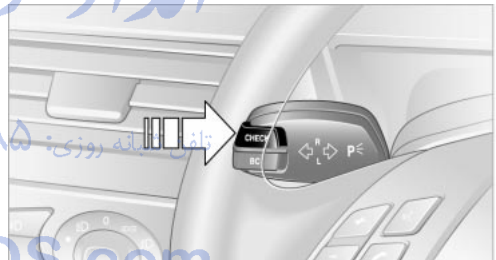

To hide a displayed message: briefly press the CHECK button on the turn signal indicator lever.

#### Check Control symbol and information on the Control Display

Depending on the status of the monitored systems, various symbols are displayed on the Control Display:

- No malfunctions are present in the monitored systems.
- One or several faults have occurred in the monitored systems.
- Depending upon how serious the problem is, a supplementary message may also appear on the Control Display.

The symbols also indicate the status of the service requirement display, refer to page 67.

## Calling up stored messages on the Control Display

### Using the CHECK button

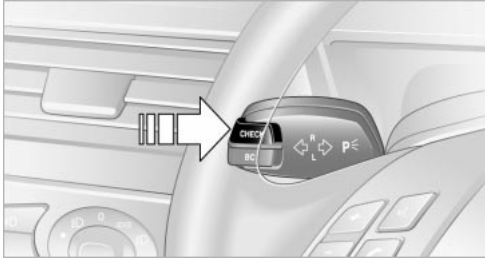

1. Press the button longer:  
The first stored message is displayed
2. Briefly press the button:  
Another message is displayed each time the button is briefly pressed.

### Using the Control Center

Control Center, for principle details, refer to page 16:

#### MENU

1. Open the start menu by pressing the button



2. Open the **i** menu by pressing the controller
3. Select "Service" and press the controller
4. Select "Check Control messages" and press the controller. The stored messages appear on the display

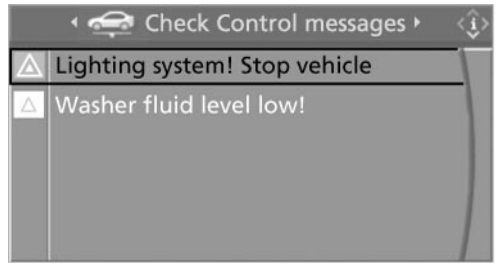

5. Select the desired message and press the controller.

The display disappears automatically after a short time.

To close the display immediately:

Select and press the controller

### Displays after completion of trip

Malfunction reports generated during the trip are shown consecutively when you switch off the ignition.

If applicable, the message "Parking lamps on!" appears at the end of a trip when you open the driver's door.

In addition, a gong sounds:

As long as the display has not disappeared, you can view the messages again. Press the CHECK button for approx. 2 seconds. If several messages are present, you can continue to press the CHECK button to view them in succession.

The Check Control function

- ▷ cancels itself automatically after a brief period
- ▷ can be canceled by again pressing the CHECK button for approx. 2 seconds.

## Computer

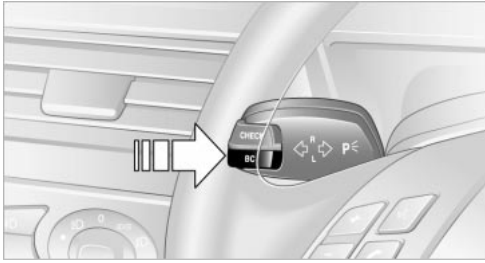

To select functions:

As of ignition key position 1, you can use the BC button in the turn signal indicator lever to call up computer information in the instrument cluster.

A new function appears each time you press the BC button briefly.

### Displays in the instrument cluster

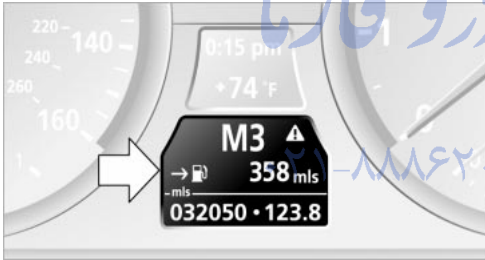

The display sequence:

- ▷ Cruising range
- ▷ Average speed
- ▷ Average fuel consumption.

### Cruising range

Displays the estimated cruising range available with the remaining fuel. The system calculates the cruising range based on operating conditions and the amount of fuel remaining in the tank. The basis for the calculations is the average fuel consumption over the preceding 20 miles/30 km.

 Always refuel as soon as possible once your cruising range falls to below 30 miles/50 km, as otherwise engine

functions are not ensured and damage can occur. ◀

Refueling is only registered by the computer for fuel amounts above approx. 1.3 gallons/5 liters.

### Average fuel consumption

The average fuel consumption is calculated for the time during which the engine is running.

You can use the Control Display to view your fuel consumption rate over two different distances, refer to Computer or Trip computer.

To reset the average fuel consumption to zero: press the BC button in the turn signal indicator lever for approx. 2 seconds.

### Average speed

Periods with the vehicle parked and the engine switched off are not included in the calculations of average speed.

To reset the average speed to zero: press the BC button in the turn signal indicator lever for approx. 2 seconds.

### Displays on the Control Display

You can also call up the computer via the Control Center, for principle details, refer to page 16:



1. Open the start menu by pressing the button



2. Move the controller to the right to open "Navigation".  
On vehicles without navigation: open "Car Data"



3. Select "Car Data" and press the controller.

You have two possibilities to display information of the computer:

- ▷ Computer
- ▷ Trip computer

It is best to use this for driving on vacation, as when you reset the values to zero, all the functions are reset together and then restart.

## Computer

Select "Onboard info" and press the controller.

Car Data		
Onboard info		
4:10	pm	Arrival time
867	mls	Cruising range
279	mls	<b>Distance to destin.</b>
48,5	mph	Speed
23,0	mpg	Fuel cons.

- ▷ Estimated time of arrival at destination. Manually enter a distance in the computer or a destination in the navigation system, see below or refer to page 116
- ▷ Cruising range
- ▷ Distance to destination. Manually enter a distance in the computer or a destination in the navigation system, see below or refer to page 116
- ▷ Average speed
- ▷ Average fuel consumption.

## Trip computer

Select "Trip computer" and press the controller

Car Data		
Trip computer		
<b>Set</b>	4:10	pm
	05:40	hr
	279	mls
	48,5	mph
	23,0	mpg

- ▷ Departure time
- ▷ Driving time
- ▷ Distance traveled
- ▷ Average speed
- ▷ Average fuel consumption.

To switch the trip computer on/off and reset values to zero:

1. Select "Set" and press the controller
2. Select the desired menu item and press the controller.

## Entering a distance manually

Control Center, for principle details, refer to page 16:

1. Open "Navigation".  
On vehicles without navigation: open "Car Data"
2. Select "Car Data" and press the controller
3. Select "Onboard info" and press the controller

Car Data		
Onboard info		
4:10	pm	Arrival time
867	mls	Cruising range
279	mls	<b>Distance to destin.</b>
48,5	mph	Speed
23,0	mpg	Fuel cons.

4. Select "Distance to destin." and press the controller
5. Turn the controller to select the distance to your destination
6. Press the controller to apply the setting.

 With the destination guidance switched on, the distance is entered automatically. ◀

### Assistance window for computer and trip computer

You can display the computer or the trip computer in the assistance window.

Control Center, for principle details, refer to page 16:

1. Move the controller to the right to switch to the assistance window and press the controller

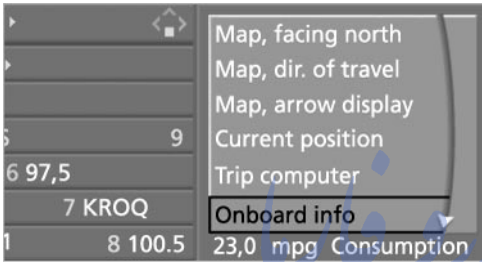

2. Select the menu item and press the controller:
  - ▷ "Onboard info"
  - ▷ "Trip computer".

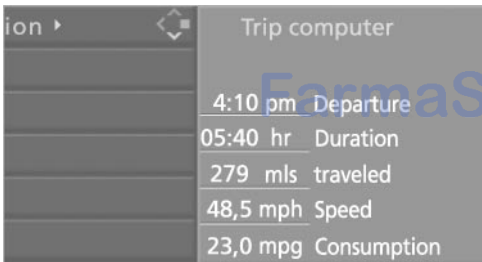

### Speed limit

You can enter a speed and a Check Control message indicates when you have reached this speed. This enables you, for example, to receive warnings if you exceed a speed limit in an urban area.

You are only warned of reaching this speed a second time if you again drive at least 3 mph/5 km/h slower.

### Adjusting, changing

Control Center, for principle details, refer to page 16:

1. Open "Navigation".  
On vehicles without navigation: open "Car Data"
2. Select "Car Data" and press the controller
3. Select "Limit" and press the controller

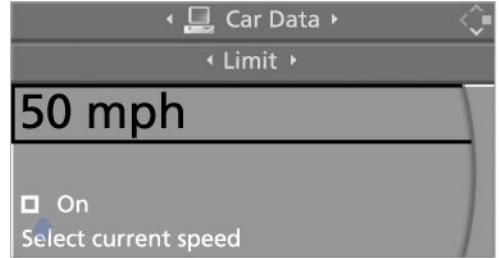

4. Select the speed and press the controller
5. Turn the controller to select the desired speed
6. Press the controller to apply the setting.

### Switching on or off

Control Center, for principle details, refer to page 16:

1. Open "Navigation".  
On vehicles without navigation: open "Car Data"
2. Select "Car Data" and press the controller
3. Select "Limit" and press the controller
4. Select "On" and press the controller.  
 is displayed with the speed limit switched on.

### Adopting your current speed as the limit

Control Center, for principle details, refer to page 16:

1. Open "Navigation".  
On vehicles without navigation: open "Car Data"
2. Select "Car Data" and press the controller

3. Select "Limit" and press the controller
4. Select "Select current speed" and press the controller. The system adopts your current speed as the limit.

## Stopwatch

Control Center, for principle details, refer to page 16:

1. Open "Navigation".  
On vehicles without navigation: open "Car Data"
2. Select "Car Data" and press the controller
3. "Select Stopwatch" and press the controller.

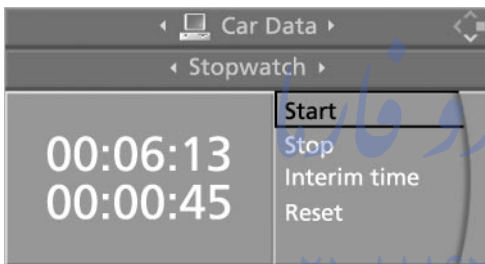

### Starting and stopping

- ▷ Select "Start" and press the controller. The stopwatch starts at the displayed time
- ▷ Select "Reset" and press the controller. The stopwatch is reset to 0 and starts
- ▷ Select "Stop" and press the controller. This stops the timer.

### Taking an intermediate time reading

Select "Interim time" and press the controller. This intermediate time appears below the ongoing primary stopwatch count.

- ▷ All of the remaining functions remain available at all times while the stopwatch is running. The stopwatch continues operation in the background.

## Changing settings

### Brightness

The brightness of the display is automatically adapted to the ambient lighting conditions. However, you can change the standard setting for each specific key.

Control Center, for principle details, refer to page 16:

#### MENU

1. Open the start menu by pressing the button



2. Open the **i** menu by pressing the controller
3. Select "Display settings" and press the controller.
4. Select "Brightness" and press the controller

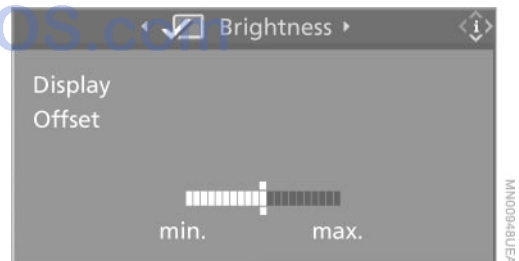

5. Turn the controller to make the adjustment
6. Move the controller forwards to adopt the set value.

### Measurement units

You can change the measurement units for consumption, distances, temperature and pressure for each specific key.

1. Open the **i** menu
2. Select "Display settings" and press the controller
3. Select "Units" and press the controller

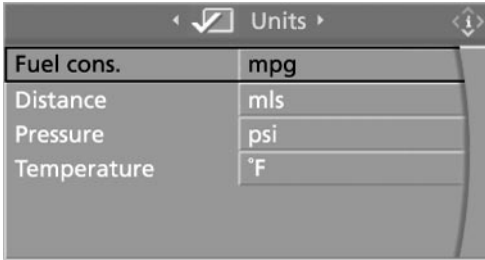

4. Select the menu item to be adjusted and press the controller
5. Select the desired measurement unit and press the controller.

### Language

The language on the Control Center can be set for each specific key.

Control Center, for principle details, refer to page 16:

1. Open the **i** menu
2. Select "Display settings" and press the controller
3. Select "Languages" and press the controller
4. Select "Text language" and press the controller. You can select a different language for the text displays

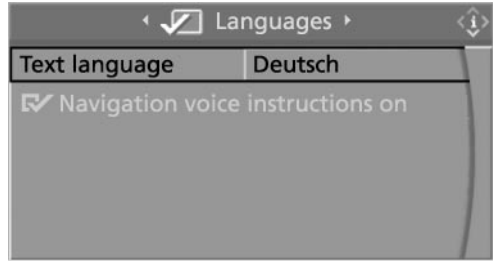

5. Select the desired language and press the controller.

### Setting the time

Control Center, for principle details, refer to page 16:

1. Open the **i** menu
2. Select "Display settings" and press the controller
3. Select "Time" and press the controller

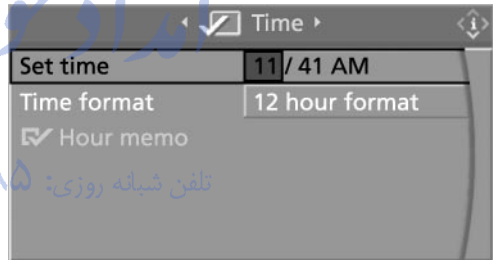

4. Select "Set time" and press the controller. The first time setting is highlighted
5. Turn the controller to make the adjustment
6. Press the controller to apply the setting. The next adjustment is highlighted
7. Make the remaining adjustments. After the last adjustment, the time is stored.

### Changing the display format

The display mode of the clock can be set for each specific key.

1. Select "Time format" and press the controller
2. Select the desired format and press the controller.

## Switching on the reminder function\*

Select "Hour memo" and press the controller.

 is displayed with the reminder function switched on.

You will hear three tones just before each full hour.

## Setting the date

Control Center, for principle details, refer to page 16:

1. Open the **i** menu
2. Select "Display settings" and press the controller
3. Select "Date" and press the controller

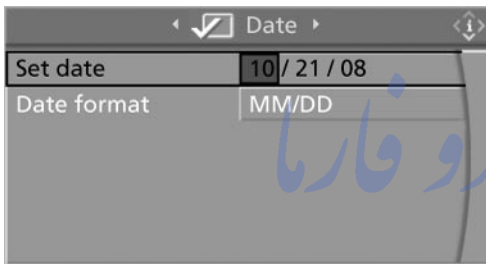

4. Select "Set date" and press the controller. The first section of the date display is highlighted, here the day
5. Turn the controller to make the adjustment
6. Press the controller to apply the setting. The next adjustment is highlighted
7. Make the remaining adjustments. After the last adjustment, the date is stored.

## Changing the display format

The display mode of the date can be set for each specific key.

1. Select "Date format" and press the controller
2. Select the desired format and press the controller.

# Technology for comfort, convenience and safety

## PDC Park Distance Control\*

### The concept

The PDC assists you when you are parking. Signal tones indicate the current distance to an object behind or in front of your vehicle. Four ultrasonic sensors in both the bumpers monitor the distance to the nearest object. The sensors at the front and at the two rear corners have a range of approx. 1.64 ft/50 cm; the rear middle sensors have approx. 5 ft/1.50 m.

 PDC is a parking aid that can indicate objects when they are approached slowly, as is usually the case when parking. Avoid approaching an object at high speed, as otherwise the physical circumstances would mean that the system warning was too late. ◀

### Automatic function

In ignition key position 2, the system automatically assumes operational status after a few seconds each time you engage reverse gear or selector-lever position R.

 Wait this short period before reversing. ◀

### Manual activation

Press the button, the indicator lamp lights up.



MN019770MA

### Manual deactivation

Press the button again; the indicator lamp goes out.

### Automatic deactivation

The system is automatically deactivated once the vehicle travels approx. 165 ft/50 m or exceeds a speed of roughly 20 mph/30 km/h; the indicator lamp goes out. You can reactivate the system manually as needed.

### Signal tones

The signal indicating the distance to the nearest obstacle is directional. Thus, an object detected to the left rear of the vehicle will be indicated by a signal tone from the left rear speaker, etc. As the distance between vehicle and object decreases, the intervals between the tones become shorter. The signal tone becomes continuous once the distance to the nearest object falls to below roughly 1 ft/30 cm.

The warning signal is canceled after approx. 3 seconds when the distance to an object remains constant during this time, if you are moving parallel to a wall, for instance.

### Malfunctions

The indicator lamp within the button flashes and a message appears on the Control Display. Please note any supplementary information that appears there.

Switch the system off and have the cause of the malfunction corrected by your BMW center.

### PDC with visual warning\*

You also enjoy the option of having the system show distances to objects on the Control Display for the specific key in use. The Control Display will also indicate the pres-

ence of objects in green before they are close enough to generate a signal tone. Control Center, for principle details, refer to page 16:

## MENU

1. Open the start menu by pressing the button



2. Open the **i** menu by pressing the controller
3. Select "Vehicle settings" and press the controller
4. Select "PDC" and press the controller

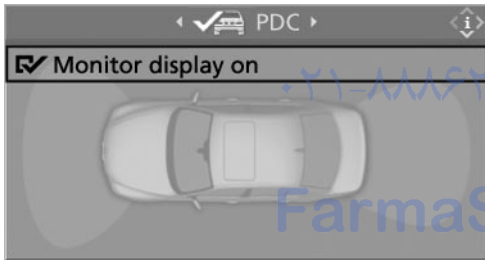

5. Select "Monitor display on" and press the controller.  
 is displayed with the PDC image switched on.

The display then appears on the Control Display as soon as PDC is automatically activated.

The previous display automatically reappears after the system is deactivated.

### Limits of the system

 Even with PDC, final responsibility for estimating the distance between the vehicle and any obstructions always remains with the driver. Even when sensors

are involved, there is a blind spot in which objects cannot be detected. The system is also subject to the physical limits that apply to all forms of ultrasonic measurement, such as those encountered with thin and wedge-shaped objects, etc. Low objects already displayed, e.g. a curb, can also disappear from the detection area of the sensors again before a continuous tone sounds.

Loud noises from outside and inside your vehicle may prevent you from hearing the PDC signal tone. ◀

 Keep the sensors clean and free of ice or snow in order to ensure that they will continue to operate effectively. Do not apply high pressure spray to the sensors for a prolonged period of time. Keep the spray at least 4 in/10 cm away from the sensors. ◀

## Driving stability control/ ABS Antilock Brake System

Your BMW is equipped with an extended array of systems designed to enhance and maintain vehicle stability under extreme conditions. The following section describes these functions based on ABS and DSC.

### The concept

ABS enhances active safety by preventing the wheels from locking under braking.

The ABS is operational every time you start the engine. ABS includes the functions CBC Cornering Brake Control and EBV Electronic Brake Force Distribution.

### In case of malfunction

 If the indicator lamp lights up in yellow, this indicates that ABS has been deactivated in response to a system malfunction. Conventional braking efficiency remains available without limitations. Please have the system inspected at your BMW center.

## CBC Cornering Brake Control

CBC is a supplement to ABS. It provides further enhancements in vehicle stability and steering response during lane changes and cornering at high rates of lateral acceleration.

## EBV Electronic Brake Force Distribution

EBV controls the brake system's application pressure at the rear wheels to ensure stable deceleration.

### In case of malfunction



If the brake system warning lamp lights up in red, appearing together with the yellow indicator lamps for ABS and DSC:

ABS

The driving stability control has failed.



If all three lamps light up yellow: Fault in the driving stability control.

The EBV electronic brake-force distribution is active.

While you may continue, you should remember to proceed cautiously and drive defensively while avoiding full brake applications.

Please have the system checked at the nearest BMW center.

If a message appears on the Control Display, please note the supplementary information.

You can find more information on the Check Control starting on page 68.



Indicator and warning lamps for Canadian models.

ABS



## Driving stability control/ DSC Dynamic Stability Control

### The concept

DSC maintains vehicle stability, even in critical driving situations.

The DSC is operational every time you start the engine. DSC includes the functionality of the DTC Dynamic Traction Control and DBC Dynamic Brake Control, refer to page 79.

The system optimizes vehicle stability during acceleration and when starting from a full stop, as well as optimizing traction. The system recognizes any tendency for the vehicle to assume an unstable attitude such as oversteer or understeer; it then counteracts this tendency with a combination of graduated reductions in engine torque and selective braking intervention at individual wheels. DSC provides optimal stability within the limits defined by the laws of physics.

### Indicator lamps



The indicator lamp in the instrument cluster goes out soon after you start the engine.

If the indicator lamp flashes:

DSC is regulating the drive and braking forces.

If the indicator lamp lights up permanently: DSC has been switched off using the button.



If the indicator lamp and the brake warning lamp light up permanently: Malfunction in DSC, DTC and DBC.

**BRAKE**

When the system is off, the stability maintenance functions described above are no longer available. The vehicle will remain completely operational, however, without DSC.

Please respond to any malfunctions by referring the problem to your BMW center.





Indicator and warning lamps for Canadian models.



## Deactivating DSC

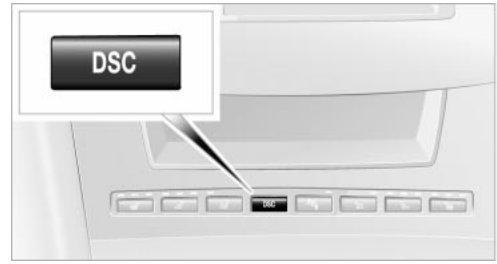

## DTC Dynamic Traction Control

In special driving states, e.g. in deep snow, DTC ensures maximum forward momentum. The gain in forward momentum also involves a reduction in driving stability. DTC is active up to 45 mph/70 km/h.

## Activating DTC



**DTC**

Press the DSC button briefly; the DTC indicator lamp in the instrument cluster lights up permanently.

You may find it useful to briefly activate DTC under the following special circumstances:

- ▶ When rocking the vehicle and starting off in deep snow or on loose road surfaces
- ▶ When ascending snow-covered hills, and when driving in deep or on hard-packed snow
- ▶ When driving with snow chains.



When DTC is active, DSC provides only limited system response up to a speed of approx. 45 mph/70 km/h. Control intervention for stability-enhancement is reduced. ◀

## Deactivating DTC again

Press the DSC button again; the DTC indicator lamp in the instrument cluster goes out. DSC is available once again without restriction.

Press the DSC button for at least 3 seconds; the DSC indicator lamp in the instrument cluster lights up permanently. DSC is deactivated.

Deactivating DSC automatically deactivates DTC as well. The systems for enhancing stability and traction are deactivated, and there is no active braking intervention or torque control.

A message appears on the Control Display. Please note any supplementary information that appears there.



To maintain optimal stability, drive with the system on whenever possible. ◀

## Reactivating DSC

Press the DSC button again briefly; the indicator lamp in the instrument cluster goes out. DSC is now activated.



The laws of physics cannot be repealed, even with DSC. An appropriate driving style always remains the responsibility of the driver. Therefore, do not reduce the additional safety margin again by taking risks.

Do not make any modifications to the DSC system. Never allow anyone other than authorized professional technicians to carry out service or repairs on the DSC system. ◀

## DBC Dynamic Brake Control

When you apply the brakes rapidly, this system automatically produces the maximum braking force boost and thus helps to achieve the shortest possible braking dis-

tance during panic stops. This system exploits all of the benefits provided by ABS. Do not reduce the pressure on the brake pedal for the duration of the brake application. When the brake pedal is released, DBC is deactivated.



In the event of a malfunction, the warning lamp in the instrument cluster lights up yellow.

Have the system checked and repaired at your BMW center as soon as possible. Please note any information that appears on the Control Display.



Warning lamp for Canadian models.

## Active roll stabilization\*

### The concept

Active roll stabilization minimizes body roll and optimizes vehicle stability during cornering and evasive maneuvers.

Dynamic stabilizers at the front and rear axles form the basis for active roll stabilization. Suspension compliance adapts to suit driving conditions, varying from performance-oriented during cornering to smooth and comfort-oriented when the vehicle is proceeding in a straight line.

The system assumes operational status each time you start the engine.

### Driving with active roll stabilization

During vehicle operation, the system continuously runs through closed-loop control cycles lasting only fractions of a second.

### In case of malfunction



The symbol in the instrument cluster lights up and a message appears on the Control Display.

Please note any supplementary information that appears there.

You can find more information on the Check Control starting on page 68.



If the active roll stabilization system is deactivated in response to malfunction, please remember to adapt your speed accordingly, especially in curves.

The suspension will be noticeably softer and the vehicle will display a greater tendency to tilt during cornering and in crosswinds.

If a message stating that you should stop appears on the Control Display in addition to the red symbol, stop immediately and switch off the engine. In this case the oil level in the reservoir may have dropped below the minimum, possibly owing to a leak in the hydraulic system.

Please note any supplementary information that appears on the Control Display. ◀

## Flat Tire Monitor

### The concept

The Flat Tire Monitor keeps track of the inflation pressures in the four fitted tires as you drive. The system provides an alert whenever the inflation pressure drops significantly in relation to the pressure in another tire.

The check of the tire inflation pressure is based on monitoring the relative speeds of the wheels. A flat tire is detected and reported on the basis of a deviation in certain speed ratios.

### Functional requirement

So that the Flat Tire Monitor can learn the correct inflation pressure, please perform the following:

1. Check the inflation pressures in all tires
2. Compare with the inflation pressure table on page 170 and correct if necessary
3. Initialize the system.

### Limits of the system



The Flat Tire Monitor cannot indicate sudden severe tire damage caused by outside factors and does not detect a

natural, even pressure drop in all four tires. ◀

In the following situations, on the other hand, there can be delays in detecting tire pressure losses, and even system failure:

- ▷ When you are driving on snow-covered or slippery road surfaces
- ▷ If you are using a sports driving style: slip on the drive wheels, high lateral acceleration
- ▷ False alarms and undetected loss of pressure may occur when you are driving with snow chains fitted
- ▷ When you are driving with the compact wheel, the Flat Tire Monitor is unable to function.

### Initializing the system

▷ Perform the initialization immediately after correcting the inflation pressure, after changing a tire or changing a wheel or all wheels. A drive is necessary for this purpose. ◀

Control Center, for principle details, refer to page 16:

1. Before beginning driving, start the engine, but do not drive off
2. Open the **i** menu
3. Select "Vehicle settings" and press the controller
4. Select "FTM" and press the controller

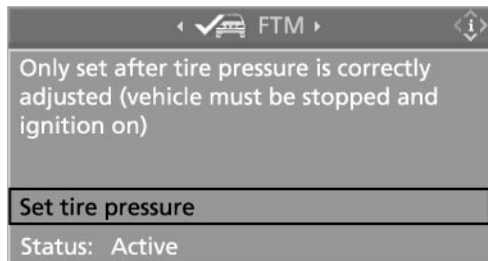

5. Select "Set tire pressure" and press the controller
6. Select "Yes" and press the controller
7. Drive off.  
The message "Initializing" is displayed.

It takes a few minutes before the Flat Tire Monitor can detect and report a flat tire. After the initialization is completed, the message "Active" is displayed.

If a flat tire is detected during initialization, a message appears on the Control Display.

▷ When driving with snow chains or with the compact wheel, do not initialize the system. ◀

### Flat tire

#### Indicator lamp



The symbol in the instrument cluster lights up in red and a simultaneous message appears on the Control Display. In addition, an acoustic signal sounds.

Please note any supplementary information that appears on the Control Display. You can find more information on the Check Control starting on page 68.

1. Reduce speed and stop the vehicle carefully. Avoid sudden braking and steering maneuvers
  2. Identify damaged tire
- ▷ If identification is not possible, contact your BMW center. ◀
3. Replace the damaged wheel, refer to Changing a tire on page 187.

Vehicles with run-flat tires:

1. Cautiously reduce the vehicle speed to below 50 mph/80 km/h. Avoid sudden braking and steering maneuvers. Do not exceed a vehicle speed of 50 mph/80 km/h
- ▷ Due to the reinforcement on the edges of the run-flat tires, inflation pressure loss can not usually be recognized from the outside, refer to Run-flat tires on page 175. ◀
2. To continue driving, comply with the instructions for driving with damaged tires on page 175.

## System malfunctions

### Indicator lamp



The symbol in the instrument cluster lights up yellow and a message appears on the Control Display.

Please contact your BMW center.

Please note any supplementary information that appears on the Control Display.

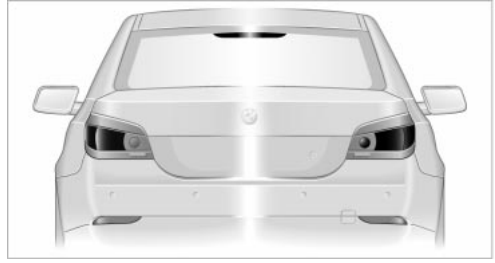

BMW02827CMAA

## Active steering\*

### The concept

The active steering is a system that actively varies the steering angle of the front wheels in relation to the steering wheel movements.

When you are driving in the low road speed range, e.g. in a town or when parking, the steering angle is reinforced, i.e. the steering becomes very direct and significantly improves the handling capability of your BMW.

In the higher road speed range, on the other hand, the steering angle is reduced, also optimizing the handling capability.

In critical situations, the system can make targeted changes to the steering angle provided by the driver and thus stabilize the vehicle before the driver intervenes.

### Indicator lamp



The indicator lamp lights up permanently: malfunction in the system.

Please have the system inspected at your BMW center.

Conventional steering efficiency remains available without limitations.

### Brake Force Display

The Brake Force Display indicates the intensity with which you are applying your brakes to drivers of following vehicles.

The display consists of two stages:

- ▷ Normal braking:  
The brake lamps in the tail assemblies and the high-mount brake lamp on top of the rear window light up during braking
- ▷ Heavy braking and braking with ABS:  
The tail lamps also light up with the same intensity as the standard brake lamp units to enhance the warning effect of the brake lamps.

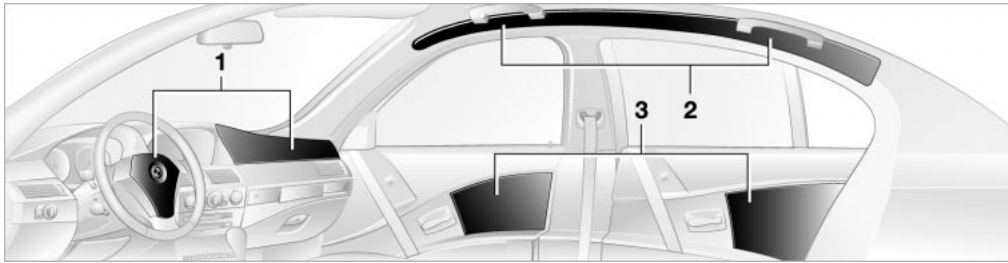

The following airbags are located under the marked covers:

- 1 Front airbags for driver and front passenger
- 2 Head airbags in front and rear
- 3 Side airbags in front and rear

## Protective effect

The front airbags help protect the driver and front passenger by responding to frontal impacts in which safety belts alone cannot provide adequate restraint. When needed, the head and side airbags help provide protection in the event of side impact. The relevant side airbag helps to restrain the side upper body area. The relevant head airbag helps to support the head and provides protection against objects entering the vehicle.

The airbags are deliberately not triggered in every impact situation, e.g. less severe accidents, certain roll-over conditions, or rear-end collisions.

 The rear seat side airbags may already have been deactivated by a BMW center. Labels in the rear door opening should indicate the status of your rear seat side airbags. If you are uncertain of their status, or wish to have the airbags activated or deactivated, please contact your BMW center. ◀

For information on the correct sitting position, refer to page 36.

 Do not apply adhesive materials to the cover panels of the airbags, cover them or modify them in any other way. Do not attempt to remove the airbag reten-

tion system from the vehicle. Never modify or tamper with either the wiring or the individual components in the airbag system. This category includes the upholstery in the center of the steering wheel, on the instrument panel, the side trim panels on the doors and the roof pillars along with the sides of the headliner. Do not attempt to remove or dismantle the steering wheel. Do not touch the individual components directly after the system has been triggered, because there is a danger of burns. If you note any indication of system malfunction, if you desire to have an airbag deactivated, or if the airbag retention system is triggered in response to an accident, you should always entrust all inspection, repair and dismantling operations to your BMW center.

Unprofessional attempts to service the system could lead to failure in an emergency or undesired airbag activation, either of which could result in personal injury. To ensure compliance with official safety regulations, please also entrust disposal of airbag generators to a BMW center. ◀

Airbag warning information is also provided on the sun visors.

## Automatic deactivation of the front passenger airbags

Your BMW has a seat occupation detection system. By evaluating the weight on the front passenger's seat, the system detects whether or not the seat is occupied by a child in the child-restraint system or an adult.

- ▷ When a child is seated in the child-restraint system or with an empty seat, the front and side airbags are automatically deactivated on the passenger's side
- ▷ When an adult is traveling in the front seat, the front and side airbags remain active on the passenger side.

**⚠** Although not desired, it can occur in the case of heavier children that the front passenger airbags remain active or in the case of very light adults or young persons that the front passenger airbags are deactivated.

The state of the front passenger airbags is shown with the telltale lamp, refer to Indicator lamps in the following. In this case transport the corresponding persons on the rear seat.

Except when persons to be transported, do not increase the load on the front passenger seat with additional items. Do not fit seat covers, seat cushion padding, ball mats or other items to the front passenger seat unless they are specifically recommended by BMW. Do not place any items under the seat. Otherwise, the function of the seat occupation detection could be impaired. ◀

### Indicator lamps

#### Operational readiness of airbag system



The airbag indicator lamp in the instrument cluster indicates the operational readiness of the entire airbag system and the safety belt tensioners as of ignition key position 1. The indicator lamp goes out after a few seconds.



The telltale lamp above the interior rearview mirror indicates whether the front-passenger airbag system is activated or deactivated as of ignition key position 1.

**▷** The telltale lamp refers exclusively to the front-passenger airbag system. ◀

- ▷ The telltale lamp goes out after a few seconds.  
The front passenger airbags are active, e.g. when transporting an adult
- ▷ The telltale lamp lights up continuously.  
The front passenger airbags are deactivated, e.g. when transporting a child in the child-restraint system or when the seat is unoccupied.

For more information on the operating principle of the front passenger airbag system and seat occupation detection, refer to Automatic deactivation of the front passenger airbags.

#### Airbag system malfunction

**⚠** A system malfunction could prevent the system from responding in the expected manner to an impact occurring within its normal response range. Please have the airbag system inspected immediately at a BMW center. ◀

**⚠** There is a fault in the airbag system if the airbag indicator lamp in the instrument cluster behaves as follows:

- ▷ Indicator lamp does not light up as of ignition key position 1
- ▷ It remains on continuously
- ▷ Indicator lamp lights up while the vehicle is being driven.

## Head-Up Display\*

### The concept

The Head-Up Display can be used to project important information into the field of vision of the driver, e.g. instructions of the navigation system. You can assimilate this information without taking your eyes off the road.

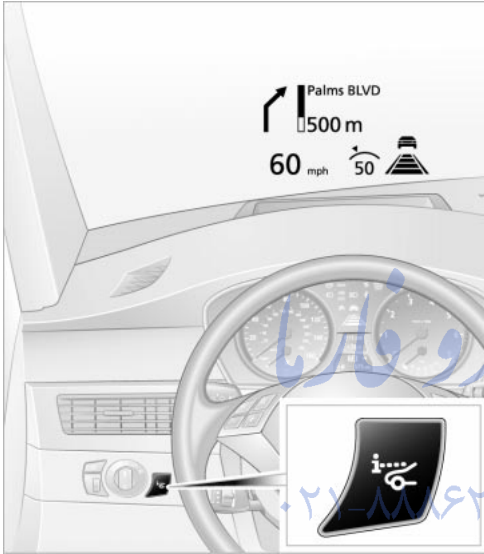

### Switching on/off

In ignition key position 2:  
Press button 2 to activate or deactivate this system.



- 1 Instructions of the navigation system
- 2 Cruise control or Active cruise control
- 3 Speed

The Head-Up Display can also be activated and deactivated with the two programmable function buttons on the steering wheel. Programming button functions, refer to page 44.

### Specifying selected displays

You can specify which information is to appear in the Head-Up Display for a specific key.

**⚠** Make all entries with the vehicle stationary. If you are inattentive, you may be in violation of the law, and can endanger vehicle occupants and other road users. ◀  
Control Center, for principle details, refer to page 16:

#### MENU

1. Open the start menu by pressing the button.



1. Open the **i** menu by pressing the controller
2. Select "Display settings" and press the controller
3. Select "HUD selection" and press the controller

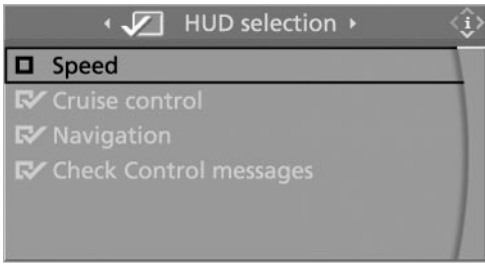

- Select the desired information of the Head-Up Display and press the controller.
  - The information is shown on the Head-Up Display.

### Setting the brightness

The brightness of the display is automatically adapted to the ambient lighting conditions. However, you can change the base setting for each specific key. With the low beams switched on, the brightness can also be set with the adjustment wheel of the instrument lighting.

Control Center, for principle details, refer to page 16:

- Open the **i** menu
- Select "Display settings" and press the controller



- Select "Brightness" and press the controller
- Move the controller to the left to select "Head-Up Display"
- Turn the controller. The adjustment is adopted; the field can be changed.

### Malfunctions

In certain cases the recognizability of the Head-Up Display may be reduced:

- ▷ By wearing sunglasses with certain polarization filters
- ▷ By disadvantageous sitting positions
- ▷ By objects on the cover of the Head-Up Display
- ▷ By wet road surfaces and disadvantageous lighting conditions.

If the image is distorted, please have the base setting checked at a BMW center.

### Care instructions

You can find everything you need to know on this topic by consulting the separate Caring for your vehicle brochure.



- !** Only clean the cover of the Head-Up Display with a soft, lint-free cloth or with a display cleaning cloth, as otherwise damage may result. ◀



# Lamps

## Parking lamps/low beams

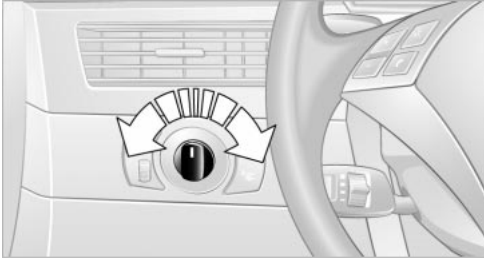

### Parking lamps

 With the switch in this position, the front, rear and side vehicle lighting is switched on. You can use the side marker lamps for parking. For lighting on one side for parking as an additional feature, refer to page 88.

### Low beams

 When you switch off the ignition with the headlamps on, the headlamps go out, and only the parking lamps remain on.

### Pathway lighting

After parking the vehicle and switching off the headlamps, operating the headlamp flasher activates the low beams. You can set the duration using the Control Center or deactivate the function.

Control Center, for principle details, refer to page 16:

1. Open the **i** menu
2. Select "Vehicle settings" and press the controller
3. Select "Lighting" and press the controller

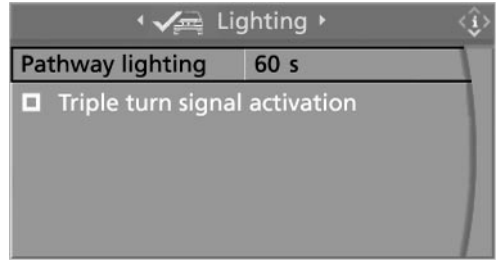

4. Select "Pathway lighting" and press the controller
5. Turn the controller to select the corresponding duration
6. Press the controller to apply the setting.

### Lights on warning

If you turn the ignition key to position 0, an acoustic signal sounds when you open the driver's door for a few seconds to remind you that the light has not yet been switched off. At the same time a message appears on the Control Display.

### Daytime driving lamps\*

If desired, the light switch can remain in the low beam position:

When you switch off the ignition, the exterior lighting goes out.

Always observe all applicable laws governing the use of daytime driving lamps.

You can switch on the parking lamps when needed using the standard procedure described under Parking lamps.

### Automatic headlamp control\*

 When you set the switch to this position, the system activates and switches on and off the low beams in response to changes in ambient light conditions, for instance, in a tunnel, at dawn and dusk, and in rain and snow. The LED next to the symbol is illuminated when the low beams are on.

 Following automatic activation, the vehicle's external lighting remains on when you switch on the fog lamps. ◀

 The automatic headlamp control cannot serve as a substitute for your personal judgment in determining when the lamps should be switched on in response to ambient lighting conditions. For example, the system cannot detect fog. To avoid safety risks, you should always switch on the lamps manually under these conditions. ◀

## Adaptive Head Light\*

### The concept

Adaptive Head Light is a variable headlamp control system that enables dynamic illumination of the road surface. Depending on the steering angle and other assumptions, the light from the headlamp follows the course of the road.

### Activating Adaptive Head Light

 In ignition key position 2, turn the light switch to the position 'Automatic headlamp control', refer to page 87.

 When reversing, the Adaptive Head Light is inactive; when the vehicle is stationary, it is only active in one direction. ◀

### In case of malfunction

The LED above the symbol for automatic headlamp control flashes. Please have the system inspected at your BMW center.

## Instrument Lighting



Turn the serrated dial to adjust the illumination intensity.

## High beams/standing lamps

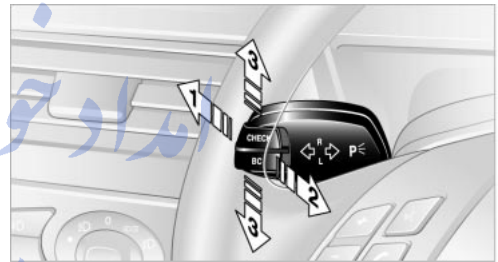

- 1 High beams: blue indicator lamp
- 2 Headlamp flasher: blue indicator lamp
- 3 Standing lamps

### Standing lamps, left or right\*

You also enjoy the option of lighting up just one side of your vehicle when parking. When using this function, comply with national regulations:

With the ignition switched off, press the lever in the desired direction 3, past the resistance point.

## Fog lamps



MN02887CMA

Always observe all applicable laws governing the use of fog lamps.

To disconnect, briefly press the button again.



The parking lamps or low beams must be switched on for the fog lamps to operate. The green indicator lamp in the instrument cluster lights up whenever the fog lamps are on.

The fog lamps are switched off whenever the high beams are switched on.



If the automatic headlamp control is activated, the low beams will come on automatically when you switch on the fog lamps. ◀

To revert to normal operation, press the button briefly.

Control of the footwell lamps, door entry lighting and courtesy lamps\* is also automatic.

## Reading lamps

Reading lamps are provided in the front and rear adjacent to the interior lamps. You can switch them on and off using the buttons 2 located next to the lamps.



To avoid discharging the battery, all of the vehicle's interior lamps are automatically switched off approx. 15 minutes after the ignition is switched off. ◀

## Light-emitting diodes LEDs

Light-emitting diodes installed behind translucent lenses serve as the light source for many of the controls and displays in your vehicle. These light-emitting diodes, which operate using a concept similar to that applied in conventional lasers, are officially designated as Class 1 light-emitting diodes.



Do not remove the covers, and never stare into the unfiltered light several hours, as irritation of the retina could result. ◀

## Interior lamps



MN02713CMA

The interior lamps operate automatically.

### Switching the interior lamps on and off manually



Briefly press button 1.

If you want the interior lamps to remain off continuously, maintain pressure on the button for approx. 3 seconds.

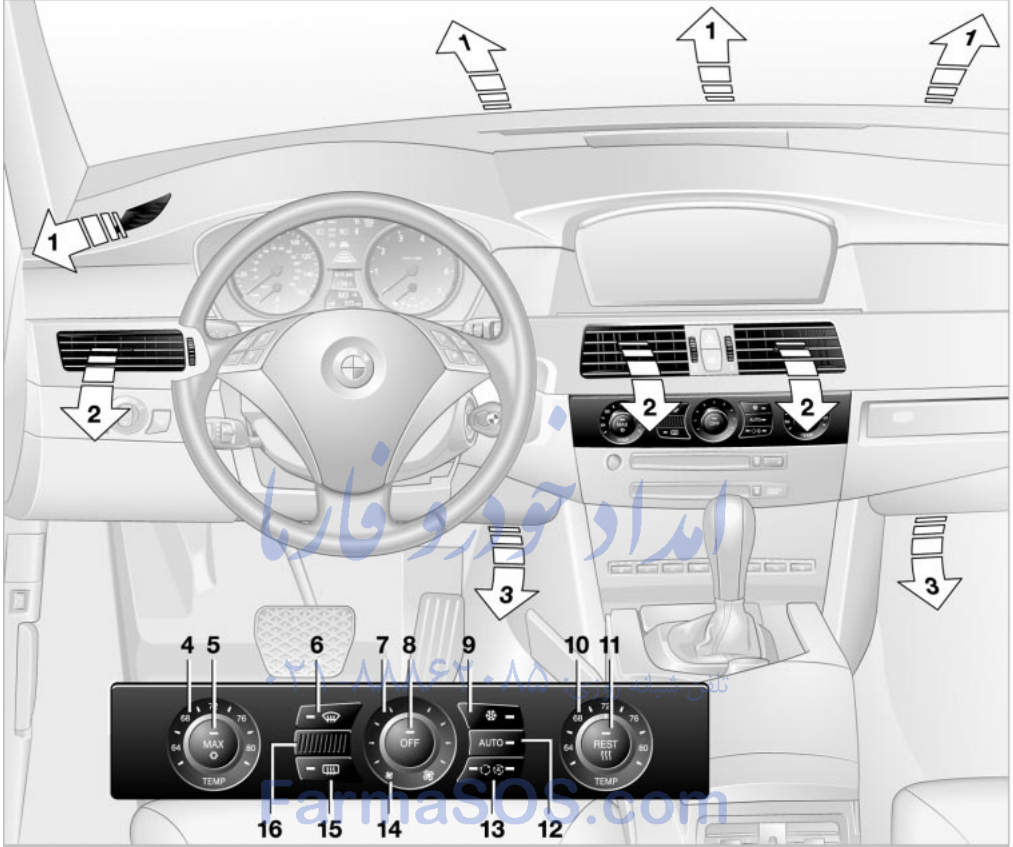
# A congenial climate



- |   |  |
|---|--|
| <ul style="list-style-type: none"> <li>1 Airflow directed toward the windshield and side windows</li> <li>2 Air to the upper body.<br/>The serrated dials allow you to open and close the air supply vent outlets through an infinitely-variable range. The levers change the direction of the air flow. You can find more information on adjusting for draft-free ventilation on page 94</li> <li>3 Air to footwell</li> <li>4 Temperature, left side of passenger compartment</li> <li>5 Maximum cooling</li> </ul> | <ul style="list-style-type: none"> <li>6 Defrosting windows and removing condensation</li> <li>7 Air volume</li> <li>8 Switching off automatic climate control</li> <li>9 Switching cooling function on and off manually</li> <li>10 Temperature, right side of passenger compartment</li> <li>11 Residual heat mode</li> <li>12 Automatic air distribution and volume</li> <li>13 Outside air/AUC Automatic recirculated-air control/Recirculated air</li> <li>14 Indicator lamp for independent ventilation</li> </ul> |
|---|--|

- ▷ Activation time set:  
The indicator lamp  lights up
- ▷ Independent ventilation switched on:  
The indicator lamp  flashes

15 Rear window defroster

16 Air grill for interior temperature sensor, please keep clear and unobstructed

All other setting options for the automatic climate control can be found in the "Climate" menu and in the  menu on the Control Display, as of page 92.

The current setting for air distribution is displayed on the Control Display.

### A congenial climate

To use the automatic function, press the AUTO button. Select an interior temperature you find pleasant.

The following section contains more detailed information on the available setting options.

The cooling function is only possible with the engine running.

### Automatic air distribution and supply



The AUTO program adjusts the air distribution to the windshield and side windows,

towards the upper body and footwell as well as the air volume, while also using your preselected temperature setting as the basis for adjusting the interior climate to adapt to external influences: summer, winter.

The cooling function comes on automatically when you select the AUTO program. At the same time, a condensation sensor controls the program in such a way that window condensation is prevented as far as possible.

### Adjusting temperature



You can turn to select the desired temperatures for the driver and passenger sides. The figures on the display provide a general indication of inte-

rior temperature. A pleasant adjustment is 72 °F / 22 °C. When you start the vehicle, the system ensures that the selected temperature is achieved as quickly as possible. It then maintains this temperature, regardless of the season.

### Defrosting windows and removing condensation



This program quickly removes ice and condensation from the windshield and front side windows.

### Adjusting the air volume manually



You can adjust the air volume by turning. You can reactivate the automatic mode for the air volume with the AUTO button.

### Switching cooling function on and off manually



The cooling function cools and dehumidifies the incoming air before also reheating it as required, according to the temperature setting. Depending on the weather, the windshield may fog over briefly when the engine is started.

The cooling function comes on automatically when you select the AUTO program.

### Maximum cooling



This program quickly provides maximum cooling.

The system switches to the recirculated-air mode and the air flows at maximum air volume only from the vent outlets for the upper body area. For this reason you should ensure that these vent outlets are open before selecting this program.

### Outside air/AUC Automatic recirculated-air control/ Recirculated air



You can respond to unpleasant odors or pollutants in the immediate environment by tempo-

rarily suspending the supply of outside air. The system then recirculates the air currently within the vehicle. AUC executes this function automatically.

Press the button repeatedly to run through the following control sequence:

- ▷ Indicator lamps off: outside air flows in
- ▷ Right indicator lamp on, AUC mode: the system detects pollutants in the outside air and responds by blocking the supply of outside air when required. The system then recirculates the air currently within the vehicle. Depending upon air quality requirements, in the automatic mode the system alternates between its outside-air and recirculated-air modes
- ▷ Left indicator lamp on, recirculated-air mode: the supply of outside air is permanently blocked. The system then recirculates the air currently within the vehicle.

**!** If condensation starts to form on the inside window surfaces during operation in the recirculated-air mode, you should switch it off while also increasing the air volume as required. The recirculated-air mode should not be used over a sustained longer period of time, as the air quality inside the vehicle deteriorates continuously. ◀

### Residual heat mode



The system uses the warmth stored in the engine to heat the interior when the ignition is off, for instance, while the vehicle is stopped at a school to pick up a

child.

You can adjust the automatic climate control settings in ignition key position 1.

**▷** Provided that the engine has warmed to its normal operating temperature and the battery is charged, you can use this function for up to 15 minutes after switching off the ignition. The LED within the button lights up to confirm compliance with these conditions. ◀

### Switching automatic climate control off



The air volume, the heater and the cooling function are all switched off. You can restart the automatic climate control by pressing any of its buttons except the REST button.

### Settings using the Control Center

You can make the settings for each specific key.

Control Center, for principle details, refer to page 16:

1. Turn the ignition key to position 2

#### MENU

2. Open the start menu by pressing the button



3. Move the controller to the left to open "Climate".

You can set the following:

- ▷ Air distribution, separate settings for driver and front passenger
- ▷ Addition of cooler air for the upper body area.

### Automatic air distribution

1. Select "Vent settings" and press the controller
2. Select "AUTO" and press the controller.



is displayed with automatic air distribution.

The program handles adjustment of the air distribution, separately for the driver and passenger side.

To switch on the automatic air distribution for the front passenger:  
Move the controller to the right.

### Manual air distribution

You can combine your air distribution yourself and also set the air temperature for the upper body area individually.

1. Select "Vent settings" and press the controller
2. Select "AUTO" and press the controller.  is displayed with manual air distribution
3. Select the desired field by moving the controller and turn the controller to adjust the air distribution.

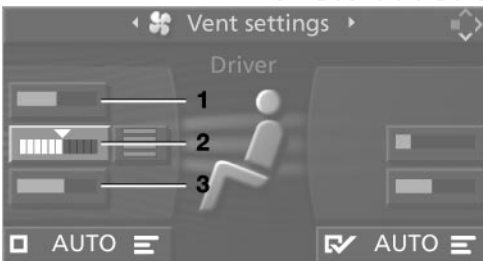

- 1 Airflow directed toward the windshield and side windows, driver's side only
- 2 Air to the upper body. You can also individually adjust the air temperature of the vent outlets for the upper body area
- 3 Air to footwell

To select the passenger area:  
Move the controller to the right.

### Adjusting temperature for the upper body

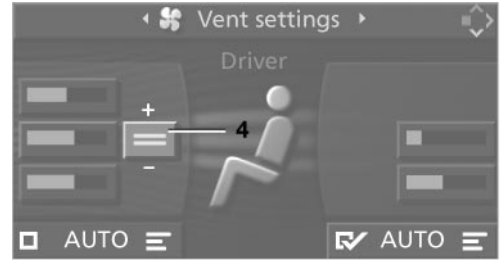

- 4 Setting the addition of cool air from the air vent outlets for the upper body area

### Setting the intensity of the AUTO program

To meet your individual needs, you can weaken or strengthen the intensity of the automatic climate control.

1. Turn the ignition key to position 1 Control Center, for principle details, refer to page 16:
2. Open the **i** menu
3. Select "Vehicle settings" and press the controller
4. Select "Climate control" and press the controller
5. "Automatic programs"

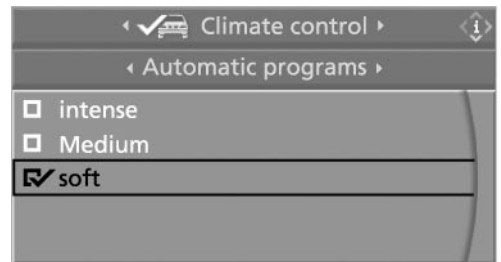

6. Select the desired intensity and press the controller.

## Front ventilation

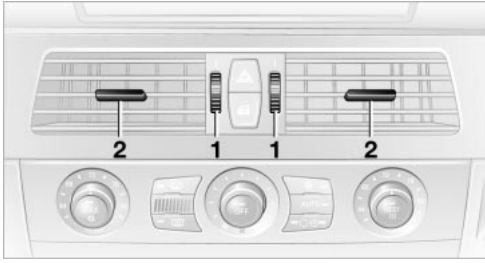

You can adjust the vent outlets for the upper body to suit your personal requirements.

You can use the serrated dials **1** to open and close the vent outlets through an infinitely-variable range, while the levers **2** allow you to adjust the airflow direction.

### Ventilation for cooling

Adjust the vent outlets to direct the flow of cool air in your direction, for instance, if the interior has become too warm, etc.

### Draft-free ventilation

Set the vent outlets so that the air flows past you and is not directed straight at you.

You can also individually adjust the air temperature of the vent outlets for the upper body area using the Control Center.

## Rear ventilation

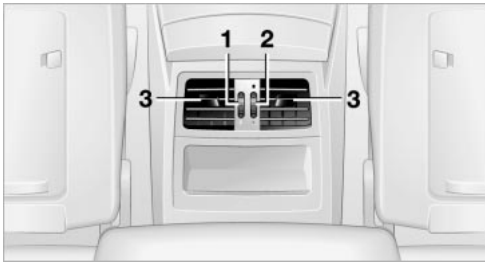

The serrated dial **1** allows you to open and close the vents through an infinitely-variable range.

Serrated dial **2**:

Turn towards blue: colder.

Turn towards red: warmer.

You can adjust the airflow direction using the levers **3**.

## Independent ventilation\*

The independent ventilation blows air into the passenger compartment to lower interior temperatures.

System operation is controlled using the Control Center. You can set two different times for the system to start.

The system remains on for 30 minutes. It can also be switched on and off directly. Since the system uses a substantial amount of electrical current, you should refrain from activating it twice in succession without allowing the battery to be recharged in normal operation between use.

The independent ventilation system is available for preprogrammed operation at outside temperatures above approx. 59 °F / 15 °C and for direct activation at any temperature, but is not operational when the vehicle is underway.

The air enters the passenger compartment through the vent outlets in the instrument cluster, which can be adjusted for both direction and airflow. These vent outlets must be open for the system to operate.

### Switching on and off directly

1. Turn the ignition key to position 1

Control Center, for principle details, refer to page 16:

2. Open "Climate"
3. Select "Independent ventilation" and press the controller
4. Select "Automatic venting" and press the controller



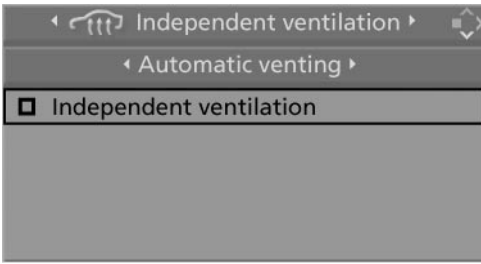

MND0105-FDEA

5. Select "Independent ventilation" and press the controller.  
 is displayed with the independent ventilation switched on.

### Setting the activation time

1. Turn the ignition key to position 1  
Control Center, for principle details, refer to page 16:
2. Open "Climate"
3. Select "Independent ventilation" and press the controller
4. Select "Activation time" and press the controller

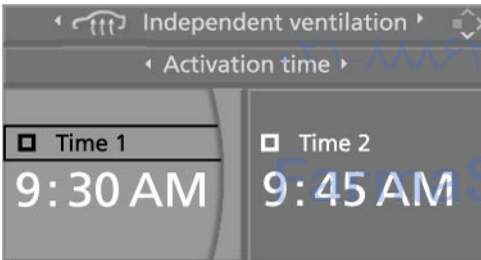

MND0105JUEA

9. Make the remaining adjustments. After the last adjustment, the time is stored.

### Activating the activation time

1. Turn the ignition key to position 1  
Control Center, for principle details, refer to page 16:
2. Open "Climate"
3. Select "Independent ventilation" and press the controller
4. Select "Activation time" and press the controller

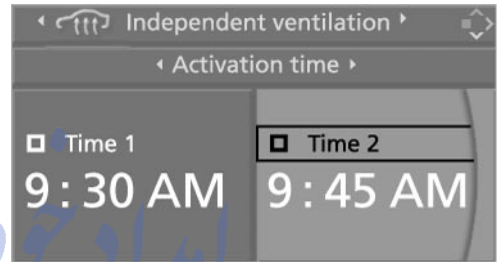

MND0105JUEA

5. Move the controller to the left or right to select "Time 1" or "Time 2" and press the controller.

is displayed with activated switch-on time. *تلفن شبانه ۰۸۵*

- The independent ventilation is only available for activation within the subsequent 24 hours. Thereafter, the time must be reactivated. ◀

You can preselect two activation times.

Maintain a time of at least 31 minutes between the first and the second switch-on time. ◀

5. Move the controller to the left or right to select "Time 1" or "Time 2"
6. Select the time and press the controller.  
The first time setting is highlighted
7. Turn the controller to make the adjustment
8. Press the controller to apply the setting.  
The next adjustment is highlighted

# Practical interior accessories

## Integrated universal remote control\*

### The concept

The integrated universal remote control replaces up to three different hand-held transmitters for various remote-controlled equipment such as door openers and house alarm systems. The integrated universal remote control registers and stores signals from the original hand-held transmitters.

The signal of an original hand-held transmitter can be programmed on one of the three memory buttons **1**. Following that, each of the devices can be actuated with the appropriately programmed memory button **1**. The indicator lamp **2** flashes to confirm transmission of the signal.

If the vehicle is sold, the memory of the buttons **1** should be cleared, refer to page 97.

 To prevent possible damage or injury, before programming or using the integrated universal remote control, always inspect the immediate area to make certain that no people, animals or objects are within the travel range of the device. Also, comply with the safety precautions of the original hand-held transmitter. ◀

### Checking the compatibility



If you see this symbol on the packaging or in the manual supplied with the original hand-held transmitter, it is safe to assume that it is compatible with the integrated universal remote control.



If you have additional questions, please consult your BMW center or call 1-800-355-3515.

You can also visit these websites:

[www.bmwusa.com](http://www.bmwusa.com) or

[www.homelink.com](http://www.homelink.com).

HomeLink is a registered trademark owned by Johnson Controls, Inc. ◀

### Programming

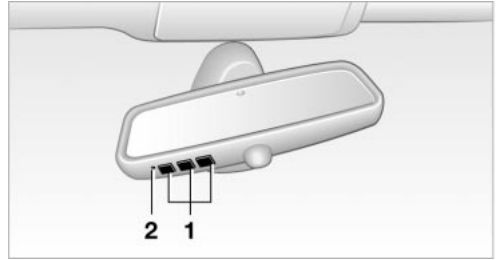

- 1 Memory buttons
- 2 Indicator lamp

### Fixed-code hand-held transmitter

1. Turn the ignition key to position 2
2. When using for the first time: Press both outer buttons **1** for approx. 20 seconds until the indicator lamp **2** flashes. The three memory buttons **1** are cleared
3. Hold the original hand-held transmitter at a distance of approx. 2 in/5 cm to 8 in/20 cm to the memory buttons **1**



The required distance between the hand-held transmitter and the memory buttons **1** depends on the relevant system of the original hand-held transmitter used. ◀

4. Simultaneously press the transmit button on the original hand-held transmitter and the desired memory button **1** on the integrated universal remote control. Initially, the indicator lamp **2** flashes slowly. Release both buttons as soon as the indicator **2** lamp flashes rapidly. If the indicator lamp **2** does not flash rapidly after approx. 15 seconds, change the distance
5. To program other original hand-held transmitters, repeat steps 3 and 4.

The corresponding memory button **1** is now programmed with the signal of the original hand-held transmitter.

The equipment can be used as of ignition key position 2.

▶ If the device cannot be used even after repeated programming, check whether the original hand-held transmitter is equipped with an alternating-code system. Here, either read the instructions for the original hand-held transmitter or hold down the programmed memory button 1 of the integrated universal remote control. If the indicator lamp 2 on the integrated universal remote control flashes rapidly for a short time then lights up for approx. 2 seconds, this indicates that the original hand-held transmitter uses an alternating-code system. In the case of an alternating-code system, program the memory buttons 1 as described at Alternating-code hand-held transmitters. ◀

### Alternating-code hand-held transmitters

To program the integrated universal remote control, consult the operating instructions for the equipment to be set. You will find information there on the possibilities for synchronization.

When programming hand-held transmitters that employ an alternating code, please observe the following supplementary instructions:

▶ Programming will be easier with the aid of a second person. ◀

1. Park your vehicle within the range of the remote-controlled device
2. Program the integrated universal remote control as described above at Fixed-code hand-held transmitters
3. Locate the button at the receiver of the equipment to be set, e.g. on the drive
4. Press the button on the receiver of the device you want to set up. After step 4, you have approx. 30 seconds for step 5
5. Press the programmed memory button 1 of the integrated universal remote control three times.

The corresponding memory button 1 is now programmed with the signal of the original hand-held transmitter.

▶ If you have any additional questions, please contact your BMW center. ◀

### Clearing the memory buttons

Press both outer buttons 1 of the integrated universal remote control for approx. 20 seconds until the indicator lamp 2 flashes. All memory buttons will be cleared.

The memory of individual memory buttons 1 cannot be cleared.

## Roller sun blinds\*

### Roller sun blind for rear window



To actuate as of ignition key position 1, briefly press the button in the driver's door.

### Roller sun blinds for rear side windows

Pull the roller sun blind at the loop and hook up to the bracket.

## Glove compartment

### Opening



Pull the handle. The light in the glove compartment switches on.

### Closing

Fold the cover up.

**⚠** To prevent injury in the event of an accident, close the glove box immediately after use. ◀

### Locking

Lock with a central key. Unlocking is also only possible with a central key.

**▶** If you only hand over the spare key, e.g. in a hotel for valet parking, refer to page 26, the glove compartment cannot be opened. ◀

### Rechargeable flashlight

The flashlight is located on the left side of the glove compartment. It features integral overload protection, so it can be left in its holder continuously.

**⚠** Be sure that the flashlight is switched off when it is inserted into its holder. Failure to comply with this precaution could lead to overcharging and damage. ◀

## Center armrest

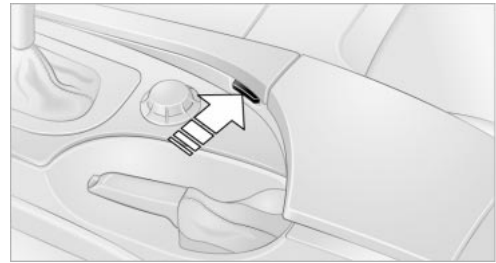

A storage compartment is located in the armrest between the front seats.

To open the cover:  
Press the button. The cover opens and can be folded upwards.

The mat within the compartment can be removed for cleaning.

Depending on the version, the storage compartment can contain a folding tray or a telephone cradle\*.

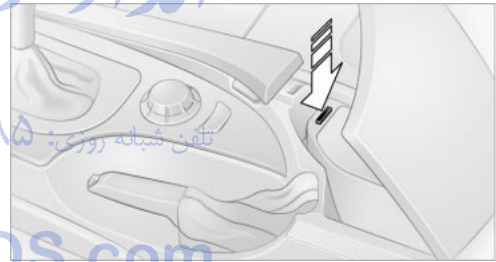

To open the tray:  
Press the button and fold the cover upwards.

The folding tray and telephone cradle\* can be folded upwards to enable use of the lower area of the storage compartment.

### Ventilating storage compartment in the front armrest

1. Fold the folding tray or telephone cradle\* upwards
2. Open or close the slider in the storage compartment.

**▶** Depending on the automatic climate control setting, the temperature within the storage compartment may be

higher than in the rest of the interior. Close the vent as required. ◀

## Adjustments

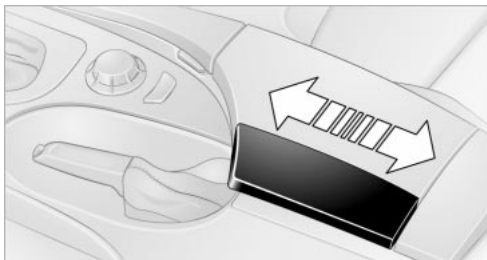

Slide the center armrest into the desired position.

## Storage compartments

### Storage compartment on center console between the front seats

Open by pressing the cover back.

### Other compartments

There are other compartments in the doors as well as in the front and rear center console.

Storage nets are located on the backrests of the front seats.

### Clothes hooks

 When suspending clothing from the hooks ensure that it will not obstruct the driver's vision. Do not hang heavy objects on the hooks. If you do so, they could cause personal injury to occupants during braking or evasive maneuvers. ◀

## Beverage holders

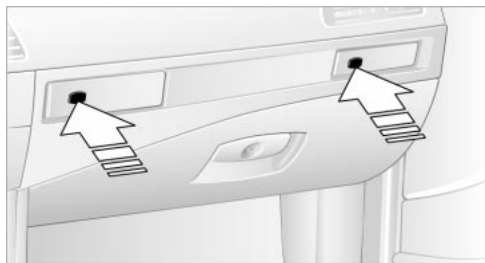

To open:  
Briefly press the button.

 Do not place containers made of glass in the beverage holders. This would lead to an increased risk of injury in the event of an accident. ◀

To close:  
Press the cover in the center and push in the beverage holder.

## Ashtray, front

### Opening

Slide back the cover.

### Emptying



Press the ashtray forwards: it rises and can be removed.

On vehicles with the non-smoking package, the insert is removed in the same way.

## Cigarette lighter, front



In ignition key position 2, press in the lighter.

The lighter can be removed as soon as it jumps back out.

 Hold or touch the hot cigarette lighter by the knob only. Holding or touching it in other areas could result in burns. Always remove the ignition key when you leave the vehicle so that, e.g., children are unable to use the lighter and burn themselves. ◀

### Lighter socket

The socket can be used to plug in hand flashlights, car vacuum cleaners, etc., with power ratings of up to approx. 200 W at 12 V. Avoid damaging the socket due to inserting plugs of different shapes or sizes.

## Ashtray, rear



### Emptying

Press the entire cover down. The ashtray rises for removal.

## Cigarette lighter, rear



Refer to Cigarette lighter, front.

## Sockets

### In front passenger footwell



Access to the socket:  
Fold the cover upwards.

### In the luggage compartment



Access to the socket:  
Fold the cover upwards.

## Rear center armrest

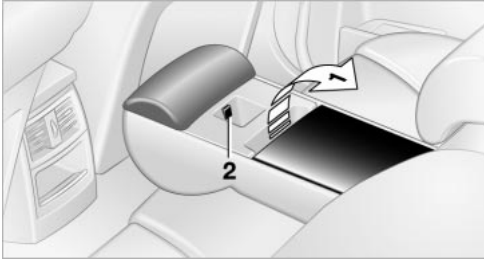

- 1 Storage compartment: pull upwards
- 2 To open the beverage holder: press and open the cover

With the center armrest folded down, you have a better view towards the rear.

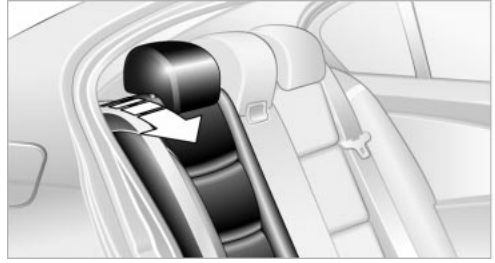

4. The unlocked rear seat back moves forward slightly. Place your hand in the gap and fold downwards.

**⚠** When you fold back the backrest, make sure that the retainer engages properly. If it is not properly engaged, transported cargo could enter the vehicle during braking or evasive maneuvers and endanger the vehicle occupants. ◀

The lashing eyes in the luggage compartment provide you with a means of attaching luggage nets\* or flexible straps for securing suitcases and luggage, refer to page 109.

## Fold down rear seat\*

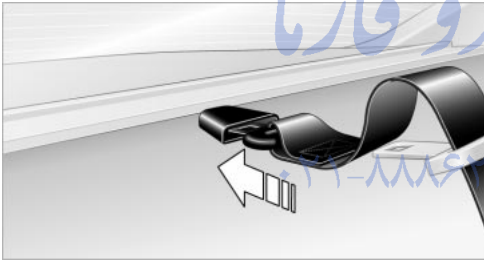

1. Open the buckle of the middle safety belt in the rear and insert the belt tongue at the end of the belt in the mounting on the back shelf
2. Push the corresponding head restraint down as far as it will go, refer to page 40

## Ski bag\*

Designed for safe, convenient transport of up to four pairs of standard skis or up to two snowboards.

The ski bag itself plus the additional capacity provided by the luggage compartment make it possible to transport skis with a length of up to 6.9 ft/2.10 m. When skis of 6.9 ft/2.10 m in length are loaded, the ski bag will tend to contract, reducing its overall capacity.

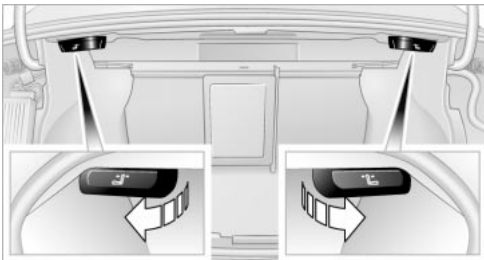

3. To unlock, pull the corresponding lever in the luggage compartment

## Loading

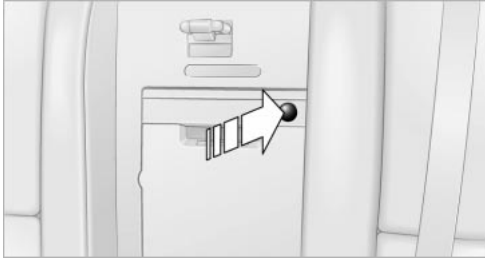

1. Pull down the center armrest, press the button and open the cover
2. Press the button again; the cover in the luggage compartment opens. If you press the button firmly the first time, this also opens the cover in the luggage compartment
3. Extend the ski bag between the front seats and fill it. The zipper allows more convenient access to stored objects and can also be left open to allow the ski bag to dry

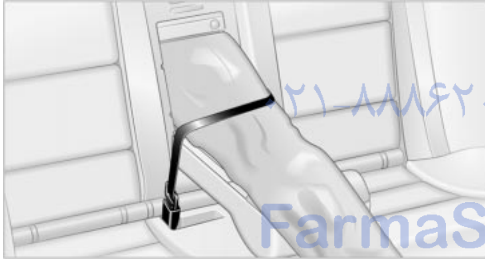

4. Insert the belt tongue of the ski bag belt in the center safety belt buckle.

Please ensure that the skis are clean before loading them into the bag. Take care to avoid damage from sharp edges.

## Securing the load

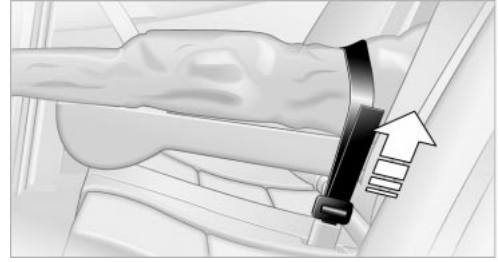

Secure the bag's contents by tightening down the strap at the buckle.

**!** Secure the ski bag in this way. If you fail to do so, it could move around and endanger occupants during braking or evasive maneuvers. ◀

To store the ski bag, perform the above steps in reverse order.

## Removing the ski bag

The ski bag can be completely removed to clean it and to use other inserts.

**▷** Your BMW center will be glad to provide you with more detailed information on the various items of equipment. ◀



Pull the handle forwards and remove the ski bag upwards, then close the cover in the luggage compartment.

**!** Do not position cargo at the opening. If you do, it can endanger the passengers during braking or evasive maneuvers. Always close off the passage with an insert, as otherwise objects from the luggage compartment can enter into the passenger compartment. ◀



# امداد خودرو فارما

تلفن شبانه روزی: ۰۲۱-۸۸۸۶۲۰۸۵

**FarmaSOS.com**



# امداد خودرو فارما

تلفن شبانه روزی: ۰۲۱-۸۸۸۶۲۰۸۵

[FarmaSOS.com](http://FarmaSOS.com)

## Driving tips

This section is designed to provide you with extra support by supplying information useful in dealing with specific driving and operating conditions.

امداد خودرو فارما

تلفن شبانه روزی: ۰۲۱-۸۸۸۶۲۰۸۵

FarmaSOS.com

# Things to remember when driving

## Break-in procedures

To ensure that your vehicle continues to provide optimized economy of operation throughout an extended service life, we request that you devote careful attention to the following section.

### Engine and differential

Up to 1,200 miles/2,000 km:

You should attempt to vary both vehicle and engine speeds. Until the break-in period has been completed, you should also refrain from exceeding an engine speed of 4,500 rpm or a driving speed of 100 mph/160 km/h.

Always obey all official speed limits.

Avoid full-throttle operation and use of the transmission's kickdown mode during these initial miles.

Once you have driven 1,200 miles/2,000 km, the engine and vehicle speeds can be gradually increased.

You should also comply with these break-in procedures should the engine or differential need to be replaced at a later point.

### Sequential manual transmission SMG

Do not use the acceleration assistant during the break-in period.

### Tires

Due to technical factors associated with their manufacture, tires do not achieve their full traction potential until after an initial break-in period. Therefore, drive reservedly during the first 200 miles/300 km.

### Brake system

Brakes require an initial break-in period of approx. 300 miles/500 km to achieve optimized contact and wear patterns between brake pads and rotors.

### Clutch

The function of the clutch is only at its optimized level after a distance driven of approx. 300 miles/500 km. During this break-in period, engage the clutch gently.

## General driving notes

### High temperatures

 Extreme temperatures occur at the catalytic converter on this and every catalyst-equipped vehicle. Do not remove the heat shields installed adjacent to various sections of the exhaust system, and never apply undercoating to them. When driving, standing at idle and while parking take care to avoid possible contact between the hot exhaust system and any highly flammable materials such as hay, leaves, grass, etc. Such contact could lead to a fire, and with it the risk of serious property damage as well as personal injury. ◀

### Parking the vehicle

Condensation forms in the air conditioner system during operation, and then exits under the vehicle. Traces of condensed water under the vehicle are thus normal.

### Before driving into the car wash

Fold in the exterior mirrors, refer to page 42, as otherwise they could be damaged due to the width of the vehicle.

### Hydroplaning

 When driving on wet or slushy roads, reduce road speed. If you do not, a wedge of water can form between tires and road surface. This phenomenon is referred to as hydroplaning, and is characterized by a partial or complete loss of contact between the tires and the road surface, ultimately undermining your ability to steer and brake the vehicle. ◀

The risk of hydroplaning increases as the tread depth of the tires decreases, refer also to Tire tread on page 173.

## Water on the road

 Do not drive through water on the road if it is deeper than 1 ft/30 cm, and then only at walking speed at the most. Otherwise, the vehicle's engine, the electrical systems and the transmission may be damaged. ◀

## Brakes

Your BMW is equipped with ABS as standard. The best way to achieve optimized response from the ABS is to apply maximum pressure to the brake pedal during emergency: panic stops. Since the vehicle maintains steering responsiveness, you can nevertheless avoid possible obstacles with a minimum of steering effort.

Pulsation at the brake pedal combines with sounds from the hydraulic circuits to indicate to the driver that ABS is in its active mode.

 Do not drive with your foot resting on the brake pedal. Even light but consistent pedal pressure can lead to high temperatures, brake wear and possibly even brake failure. ◀

## Driving in wet conditions

While driving in wet conditions and in heavy rain, it is a good idea to apply light pressure to the brake pedal every few miles. Monitor traffic conditions to ensure that this maneuver does not endanger other road users. The heat generated in this process helps dry the pads and rotors to ensure that full braking efficiency will then be available when you need it.

## Hills

You can retain full and unimpaired braking efficiency by downshifting to a gear in which only minimal brake applications are needed when descending long or steep downhill stretches.

You can further enhance the engine's braking effect by selecting a lower gear in the automatic transmission's manual mode, downshifting as far as first gear on extremely steep stretches, refer to pages 50 and 55. This strategy helps you avoid placing excessive loads on the brake system.

 Never drive with the clutch pressed or allow the vehicle to coast with the transmission in Neutral – or with the engine switched off – there is no engine braking when the transmission is in Neutral, and no power-assist for brakes and steering when the engine is not running. Never allow floor mats, carpets or any other objects to protrude into the area around the accelerator and brake pedals and obstruct their movement. ◀

## Corrosion on the brake rotors

When the vehicle is driven only occasionally, during extended periods when the vehicle is not used at all, and in operating conditions where brake applications are less frequent, there is an increased tendency for corrosion to form on rotors, while contaminants accumulate on the brake pads. This occurs because the minimum pressure which must be exerted by the pads during brake applications to clean the rotors is not reached.

Should corrosion form on the brake rotors, the brakes will tend to respond with a pulsating effect that even extended application will fail to cure.

## Brake pads

 The brake pad wear warning lamp lights up and a message appears on the Check Control. Please note any supplementary information that appears there.

 Warning lamp for Canadian models.

The brake pads have reached their minimum pad thickness. Have them replaced at your BMW center as soon as possible.

 For your own safety: use only brake pads that BMW has approved for your particular vehicle model. As BMW cannot assess the suitability of other brake pads for use on your vehicle, we are unable to assume continued responsibility for the vehicle's operating safety if non-approved pads are installed. ◀

### Mobile communication in the vehicle

BMW recommends using mobile communication devices, e.g. portable phones, in the interior of the vehicle with a suitable external antenna. Otherwise, the vehicle electronics and mobile communication device can influence one another.

## Loading

 To avoid loading the tires beyond their approved carrying capacity, never overload the vehicle. Overloading can lead to overheating and increases the rate at which damage develops inside the tires. The ultimate result can assume the form of a sudden air loss. ◀

### Determining loading limit



1. Locate the following statement on the driver's door pillar\*:

 The combined weight of occupants and cargo should never exceed XXX kg or YYY lbs, as otherwise the vehicle may be damaged and unstable driving conditions may result. ◀

2. Determine the combined weight of the driver and passengers that will be riding in your vehicle

3. Subtract the combined weight of the driver and passengers from XXX kilograms or YYY pounds
4. The resulting figure equals the available amount of cargo and luggage load capacity.  
For example, if the XXX amount equals 1,400 lbs. and there will be five 150-lbs. passengers in your vehicle, the amount of available cargo and luggage load capacity is 650 lbs.:  
1,400 lbs. minus 750 lbs. = 650 lbs.
5. Determine the combined weight of luggage and cargo being loaded on the vehicle. That weight must not exceed the available cargo and luggage load capacity calculated in step 4
6. If your vehicle will be towing a trailer, part of the load from your trailer will be transferred to your vehicle. Consult the manual for transporting a trailer to determine how this may reduce the available cargo and luggage load capacity of your vehicle.

### Load

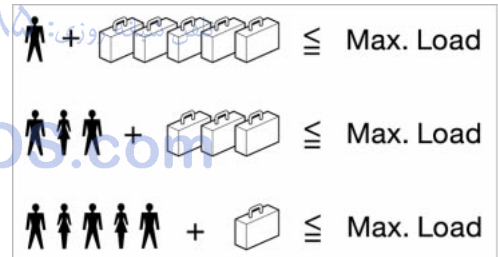

The permitted load is the total of the weight of occupants and cargo/luggage. The greater the weight of occupants, the less cargo/luggage can be transported.

## Stowing cargo

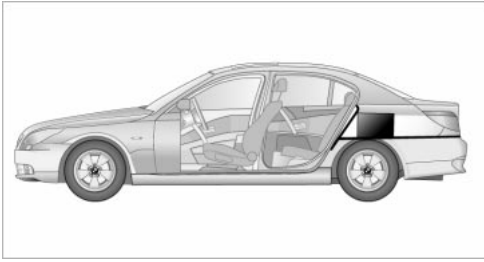

BMW19B1010M

- ▷ Load heavy cargo as far forward and as low as possible, placing it directly behind the bulkhead behind the rear seats
- ▷ Cover sharp edges and corners
- ▷ For very heavy cargo when the rear seat is not occupied, secure each safety belt in the opposite buckle.

## Securing the load



BMW20B3C1M

- ▷ Use the luggage net\* or securing straps to hold down small and lightweight luggage and cargo
- ▷ Heavy-duty cargo straps\* for securing larger and heavier objects are available at your BMW center. Lashing eyes mounted in the corners of the luggage compartment are used to secure this load securing equipment, refer to illustration
- ▷ Please observe the special instructions supplied with the heavy-duty cargo straps.

 Always position and secure the load correctly. If you do not, it can even endanger the passengers during braking or evasive maneuvers.

Never exceed either the approved gross

vehicle weight or either of the approved axle loads, refer to page 200, as excessive loads can pose a safety hazard, and may also place you in violation of freeway safety laws.

You should never transport heavy or hard objects unsecured in the passenger compartment, as they could fly around and even pose a safety hazard to the vehicle's occupants during abrupt braking or evasive maneuvers. ◀

## Roof-mounted luggage rack\*

### Anchorage points

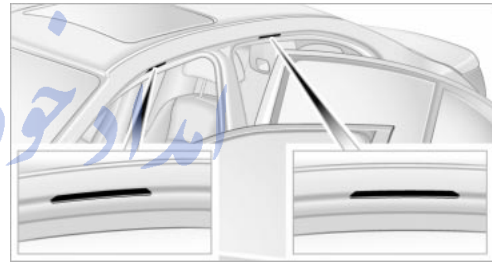

BMW19B5C1M

The anchorage points are located within the door openings.

A special rack system is available as an option for your BMW. Please comply with the precautions included with the installation instructions.

Because roof racks raise the vehicle's center of gravity when loaded, they have a major effect on its handling and steering response.

You should therefore always remember not to exceed the approved roof weight, the approved gross vehicle weight or the axle loads when loading the rack.

You can find the specified weights in the Technical data section on page 200.

Make sure that the load is not too heavy, and that it does not extend outward to beyond the limits of the loading surface. Always load the heaviest pieces first – at the bottom. Be sure that adequate clearance is maintained for raising the glass

roof, and that objects do not project into the opening path of the luggage compartment lid.

Secure roof-mounted cargo correctly and securely to prevent it from shifting or being lost during the trip.

Drive smoothly. Avoid sudden acceleration and braking maneuvers. Take corners gently.

امداد خودرو فارما

تلفن شبانه روزی: ۰۸۵-۸۸۸۶۲-۰۲۱

FarmaSOS.com



# امداد خودرو فارما

تلفن شبانه روزی: ۰۲۱-۸۸۸۶۲۰۸۵

[FarmaSOS.com](http://FarmaSOS.com)



# امداد خودرو فارما

تلفن شبانه روزی: ۰۲۱-۸۸۸۶۲۰۸۵

[FarmaSOS.com](http://FarmaSOS.com)

## Navigation

This section contains various examples that illustrate how the navigation system provides you with reliable guidance to your destination.

امداد خودرو فارما

تلفن شبانه روزی: ۰۲۱-۸۸۸۶۲۰۸۵

FarmaSOS.com

# Starting navigation system\*

Your navigation system can use satellites to ascertain the precise position of your vehicle and guide you reliably to any destination you enter.

## Navigation CD/DVD

In your navigation computer, you can use special navigation CDs/DVDs.

To ensure that your vehicle's navigation system has access to the latest highway network information, always load the most recent CD/DVD version.

Navigation CDs/DVDs are available at your BMW center.

## Inserting the navigation CD/DVD

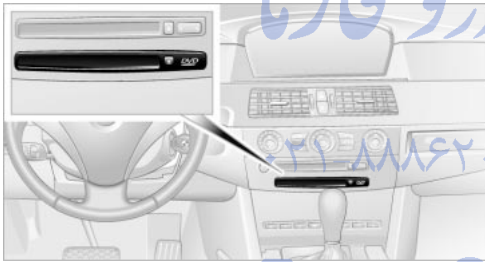

1. Insert the navigation CD/DVD with the labeled side up
2. Allow eight seconds for the system to scan the data from the CD/DVD.

## Removing the navigation CD/DVD

In the center console:

1. Press the button



The CD/DVD is ejected from the navigation computer

2. Remove the CD/DVD.

## Opening the navigation

**!** Enter data only when the vehicle is stationary, and always obey the traffic regulations and road signs in the event of any contradiction between traffic and road conditions and the instructions issued by the navigation system. If you do not observe this precaution, you may be in violation of the law, and can endanger vehicle occupants and other road users. ◀

Control Center, for principle details, refer to page 16:

### MENU

1. Open the start menu by pressing the button



2. Move the controller to the right to open "Navigation"

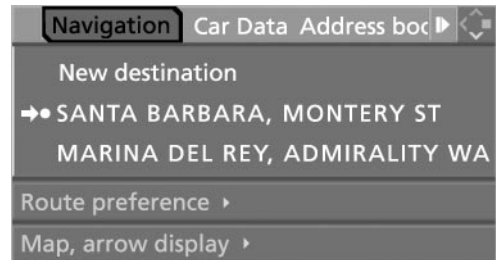

3. Select "Navigation" and press the controller

## Display in assistance window

You can have the route or current position displayed in the assistance window in such a way that it remains visible even if you switch to another menu.

1. Move the controller to the right to switch to the assistance window and press the controller

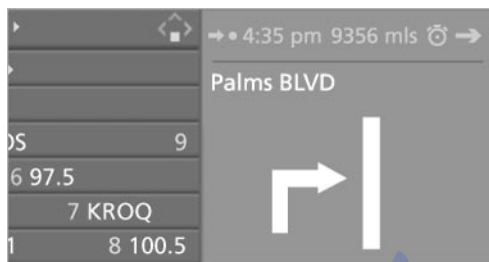

2. Select the desired view of the route and press the controller:
  - ▷ "Map, facing north"
  - ▷ "Map, dir. of travel"
  - ▷ "Map, arrow display"
  - ▷ "Current position".

The contents of the assistance window is continually updated as you drive.

## Displaying position

Control Center, for principle details, refer to page 16:

1. Select "Navigation" and press the controller

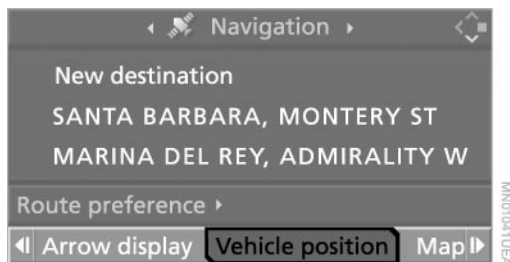

2. Select "Vehicle position" and press the controller.

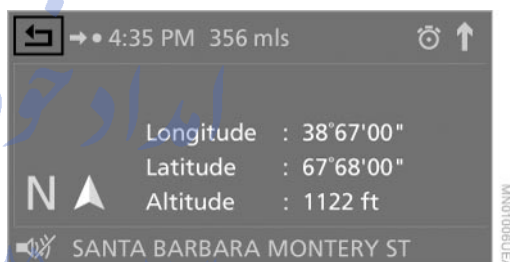

You can call up the current position of your BMW. If the navigation system is unable to identify a town or city, your current map coordinates will appear.

To exit the menu:

Select  and press the controller.

# Destination entry

In entering your destination you can select from among the following options:

- ▷ Entering a destination manually, see below
- ▷ Selecting destination via information, refer to page 118
- ▷ Selecting from among recent destinations, refer to page 119
- ▷ Selecting destination from address book, refer to page 120.

After selecting your destination you can proceed to start the destination guidance system, refer to page 123.



Enter data only when the vehicle is stationary, and always obey the traffic regulations and road signs in the event of any contradiction between traffic and road conditions and the instructions issued by the navigation system. If you do not observe this precaution, you may be in violation of the law, and can endanger vehicle occupants and other road users. ◀

## Entering a destination manually

The system supports the wordmatch principle to make it easier for you to enter the names of streets or towns. This enables input of different spellings and supplements your input automatically so that stored names can be adopted as destinations as quickly as possible, refer to page 122.

Control Center, for principle details, refer to page 16:

1. Select "Navigation" and press the controller



2. Select "New destination" and press the controller
  - ▷ Select "Enter address" and press the controller.

Note the following special features:

- ▷ If you do not enter a street, the system will guide you to the downtown area of a town or city
- ▷ Depending on the data stored on your navigation CD/DVD, you can also enter the house or building number on some streets
- ▷ You can skip the entry of country and locality if the current entries are being retained for your new destination
- ▷ Destination input using the Control Center differs from destination entry using the voice command system.

## Select the country of the destination

When the name of a country appears in white letters on the Control Display, this indicates that data for more than one country is stored on the map CD/DVD.

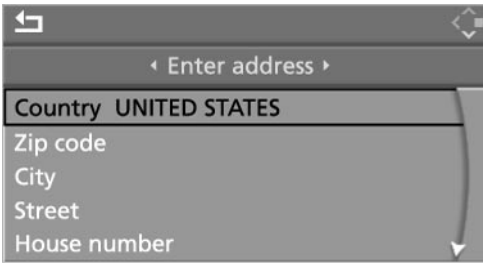

1. Select "Country" or the displayed country and press the controller.  
A list of available countries appears in the display
2. Select the country of destination and press the controller.

### Entering city of destination or zip code

In order to be able to start the destination guidance, at least the city of destination or its zip code must be entered.

1. Select "City" or the displayed city and press the controller



2. To enter the zip code:  
Select digits individually and press the controller.  
The corresponding city of destination is supplemented.  
To enter the city of destination:  
Select the first starting letters and press the controller.  
A list of all towns/cities starting with this letter appears on the Control Display
3. If necessary, enter other letters.  
The list gradually grows smaller each time you enter a new letter.

To enter blanks:  
Select **\_** and press the controller.

To delete the last letter:  
Select **←** and press the controller

4. Select the city name from the list and press the controller.

### Entering street, house number and intersection

1. Select "Street" or the displayed street and press the controller

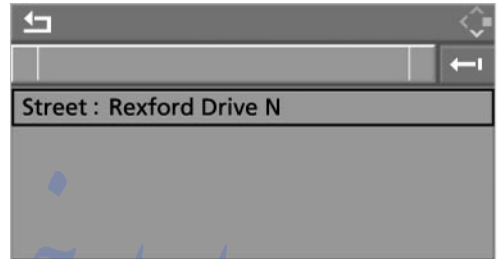

2. For instructions on entry, refer to Entering city of destination.

After the street you can also enter the intersection or the house number.

The procedure for entering intersections is basically the same as that used for streets.

Entering house number, e.g. "194":

1. Select "House number" and press the controller
2. To enter "194":  
Select digits individually and press the controller.

To delete the last letter or digit:  
Select **←** and press the controller

3. Select the house number shown on the Control Display and press the controller.

If all of the house numbers on a street are not stored on the navigation CD/DVD, a selection list with number ranges is displayed. The option for entering house numbers will not be offered if no house numbers are stored for the selected street on your navigation CD/DVD.

If destination guidance is not to be started immediately, the destination can be accepted as one of the recent destinations, refer to page 119:

Select "Add to destination list" and press the controller.

## Starting destination guidance with manual destination entry

Select "Start guidance" and press the controller.

Destination guidance starts immediately.

## Map-guided destination selection

Assume that you only know the general position of your destination's street or locality. Then the system offers you maps in which you can use the target cursor to limit the destination and then adopt it into the destination guidance.

Control Center, for principle details, refer to page 16:

1. Select "Navigation" and press the controller
2. Select "New destination" and press the controller
3. Select "Input map" and press the controller.

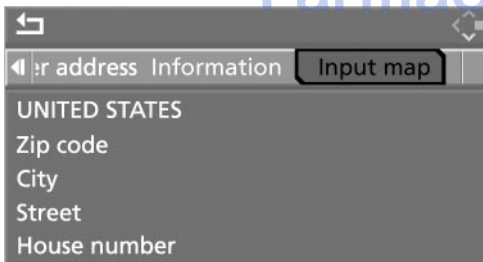

A map section is displayed on the Control Display around the first destination from the destination list, even if the destination guidance is switched off

4. Push the controller in the desired direction to localize your destination. The controller can be moved to the left, right, forward, back and also diagonally.

To adjust the scale:

Turn the controller.

The destination is detected for scales under 0.5 mls/1 km

5. Press the controller to display the selected city of destination and a list of additional menu items:

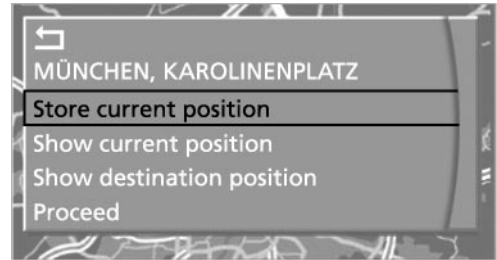

6. Select the desired menu item and press the controller:

- ▷ closes "Input map"
- ▷ "Start route guidance" switches the destination guidance on
- ▷ "Show current position" places the position back in the center of the map
- ▷ "Show destination position" places a selected city of destination in the center of the map
- ▷ "Proceed" switches back to "Input map".

## Selecting destination using information

You can obtain a display of selected destinations for certain cities or countries and adopt them into the destination guidance, e.g. hotels, sights or hospitals.

Control Center, for principle details, refer to page 16:

1. Select "Navigation" and press the controller
2. Select "New destination" and press the controller
3. Select "Information" and press the controller



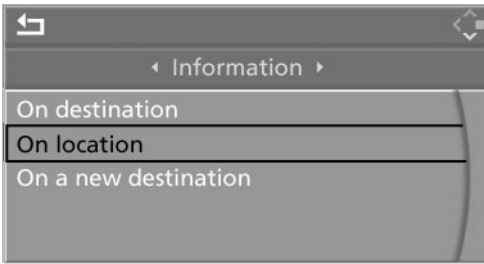

4. Select the city or country and press the controller:
  - ▷ "On destination"
  - ▷ "On location"
  - ▷ "On a new destination"
 The display for entering a city appears on the Control Display. Select the desired city and press the controller
5. Select the desired type of destination, such as "Hotels and restaurants" and press the controller. The Control Display shows
  - ▷ an alphabetical list of all entries in the selected destination category
  - ▷ for the location, a list sorted by distance with a maximum of ten destinations
6. Select a destination and press the controller
7. Select a menu item:
  - ▷ To adopt the address into the destination list: Select "Select as destination" and press the controller. The destination guidance is switched on
  - ▷ To set up a telephone connection: Select "Call" and press the controller.

To exit the menu:  
Select  and press the controller.

## Recent destinations

The system stores the last 20 destinations entered.

Control Center, for principle details, refer to page 16:



➔ indicates the current destination.

1. Select a destination and press the controller
2. The selected destination can be edited:

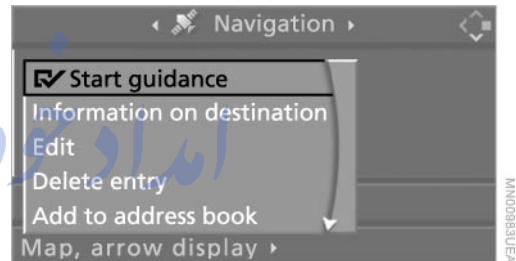

- ▷ To start the destination guidance: Select "Start guidance" and press the controller.  is displayed with the destination guidance switched on
- ▷ To display information on the destination: Select "Information on destination" and press the controller
- ▷ To edit the entry: Select "Edit" and press the controller, for operation, refer to Entering city of destination or zip code, page 117
- ▷ To delete the entry: Select "Delete entry" and press the controller
- ▷ To delete all entries: Select "Delete list" and press the controller; destination guidance is switched off

- ▷ To store the entry:  
Select "Add to address book" and press the controller.

## Address book

### Calling up the address book

Control Center, for principle details, refer to page 16:

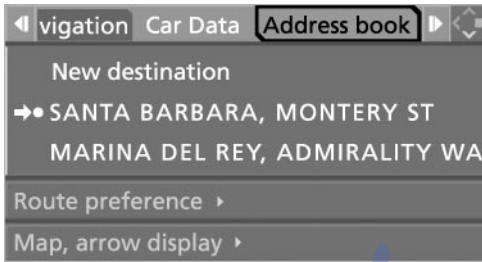

Select "Address book" and press the controller.

### Storing destinations in the address book

To make it even easier to enter frequently required destinations, the system lets you store approx. 100 destinations in the address book.

Control Center, for principle details, refer to page 16:

1. Enter the destination manually, refer to page 116, and press the controller

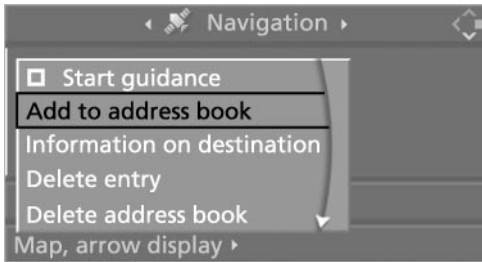

2. Select "Add to address book" and press the controller.

The entry is assigned to a name that can be changed. For operation, refer to Entering a destination manually, page 116

3. Select "Store address" and press the controller.  
The entry is stored in the address book.

### Selecting destinations from the address book

Control Center, for principle details, refer to page 16:

1. Select "Address book" and press the controller.

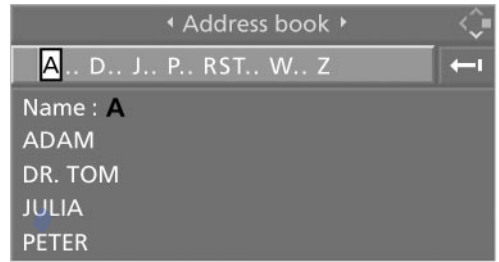

The stored entries are listed on the Control Display

2. Select the entry and press the controller.

To start the destination guidance:  
Select "Start guidance" and press the controller.

### Editing destinations from the address book

You can change the name of an entry.

Control Center, for principle details, refer to page 16:

1. Select "Address book" and press the controller
2. Select the entry and press the controller
3. Select "Edit address" and press the controller.

The given name can be changed. For operation, refer to Entering a destination manually, page 116.

### Deleting individual destinations from the address book

Control Center, for principle details, refer to page 16:

1. Select "Address book" and press the controller
2. Select the entry and press the controller
3. Select "Delete address" and press the controller.

### Deleting all destinations from the address book

Control Center, for principle details, refer to page 16:

1. Open the **i** menu
2. Select "Vehicle settings" and press the controller
3. Select "Delete data" and press the controller
4. Select "Delete address book" and press the controller
5. Select "Yes" and press the controller.

### Route selection

You can specify your route more precisely by choosing certain route criteria.

### Changing route criteria

Control Center, for principle details, refer to page 16:

1. Select "Navigation" and press the controller
2. Select "Route preference" and press the controller.

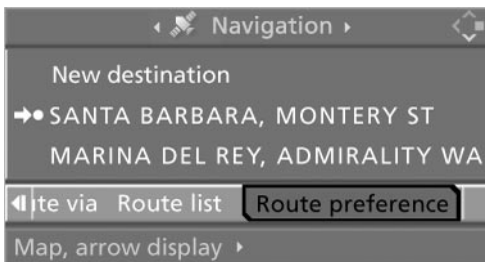

The various possibilities are listed on the Control Display

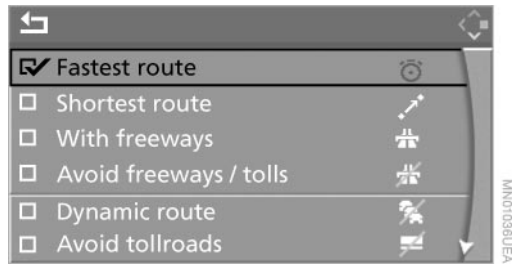

3. Select the route criteria and press the controller:

- ▷ "Fastest route"  
Shortest time using combination of smallest possible distance and sections where fast driving is possible
- ▷ "Shortest route"  
Shortest distance without consideration of the time
- ▷ "Avoid freeways / tolls"  
Freeways are avoided where possible
- ▷ "With freeways"  
Freeways and major traffic arteries are given priority

4. If necessary, select an additional route criterion and press the controller:

- ▷ "Avoid tollroads"  
Tollroads are avoided where possible
- ▷ "Avoid ferries"  
Ferries are avoided where possible
- ▷ "Dynamic route"  
The route is planned around or through traffic obstructions.

displays the selected route criteria.

To close the list:

Select and press the controller.

The navigation system relies on specific rules to determine your route. These vary according to the different kinds of roads stored on the map CD/DVD. As a result, the routes recommended by the navigation system may not always be the same ones that you would choose based on personal experience.

You can change the selected route as often as you like, both when entering your destination and at any time while the system is guiding you to it – the system revises its travel recommendations accordingly.

## Wordmatch principle

The system supports the wordmatch principle to make it easier for you to enter the names of streets or towns. The system runs ongoing checks, comparing your destination entries with the data stored on the navigation CD/DVD as the basis for instant response. The user benefits include:

- ▷ Names of specific locations can also vary from the official versions provided that the spelling of the entry corresponds to a standard form used in another country

Example:

Instead of 'München', you can also enter the English spelling 'Munich' or the Italian spelling 'Monaco'

- ▷ When you are entering the names of towns and streets the system will complete them automatically as soon as enough letters are available to ensure unambiguous identification
- ▷ The system only accepts name entries beginning with letters that are stored on the navigation CD/DVD. The system will not accept nonexistent names and addresses.

# Destination guidance

## Starting the destination guidance

Control Center, for principle details, refer to page 16:

1. Select "Navigation" and press the controller

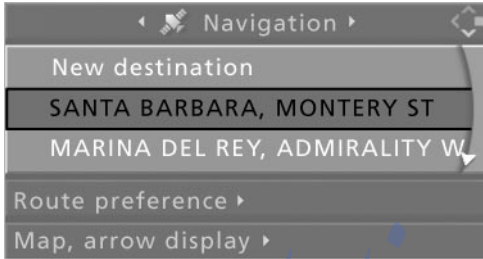

2. Select a destination and press the controller

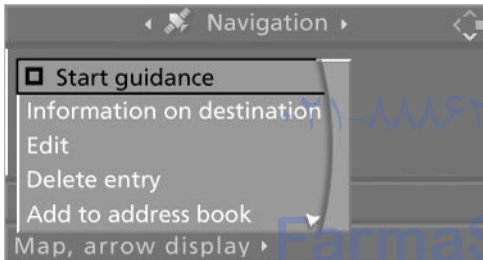

3. Select "Start guidance" and press the controller.  is displayed with the destination guidance switched on.

 indicates the current destination.

After the route has been calculated, destination guidance is indicated by arrows or a route map on the Control Display.

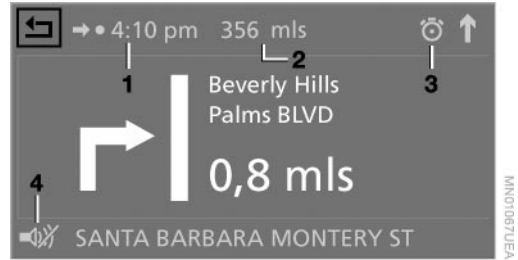

- 1 Time of arrival
- 2 Distance to destination
- 3 Route criteria
- 4 Voice instructions switched on/off

During destination guidance, you can operate other equipment using the Control Center at any time. You are informed of a required change in direction by means of spoken announcements in good time prior to every intersection.

To exit the menu:

Select  and press the controller.

## Displaying route

You have the option of displaying various views of the route.

### Switching to directional arrow mode

To switch to directional arrow mode:

1. Select "Navigation" and press the controller

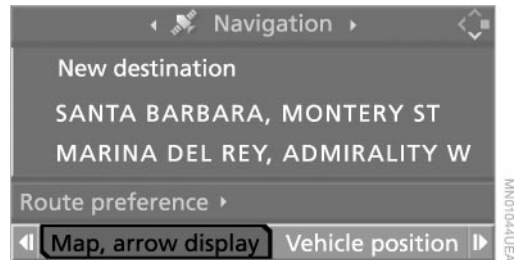

2. Select "Map, arrow display" and press the controller.

## Selecting display of route map

You can also select a map showing your travel route while the system is guiding you to your destination.

1. Select "Navigation" and press the controller

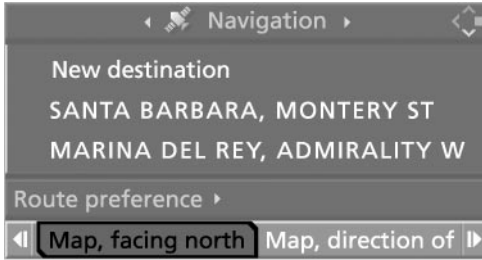

2. Select "Map, facing north" and press the controller.

### Changing scale

Turn the controller.

The map scale appears on the Control Display.

### Altering display direction

At scales of less than 300 miles/500 km, you enjoy the option of deciding whether to orient the map to north or toward your current direction of travel. From 300 miles/500 km, the map always points toward north.

Select "Map, facing north" or "Map, direction of travel" and press the controller.

## Displaying towns and streets of the route

You can have streets and towns on your route displayed whenever the destination guidance is active.

The distances remaining to be traveled on each individual road, directional arrows and traffic jam reports are also displayed.

Control Center, for principle details, refer to page 16:

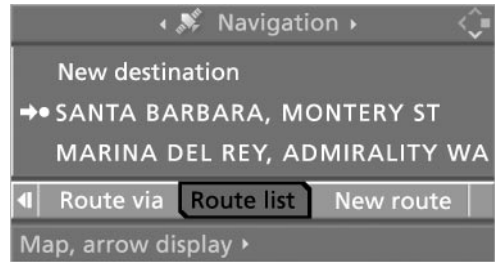

Select "Route list" and press the controller. If the system has not yet completely defined the travel route, "..." will appear in the list.

To exit the menu:

Select  and press the controller.

## Destination guidance through voice instructions

### Switching voice instructions on/off

The setting is made in dependence on a specific key.

Control Center, for principle details, refer to page 16:

1. Open the  menu
2. Select "Display settings" and press the controller
3. Select "Languages" and press the controller

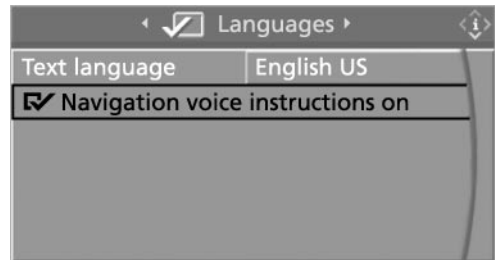

4. Select "Navigation voice instructions on" and press the controller.  is displayed with the voice instructions switched on

or press



or press



on the steering wheel for a longer period.  
Programing button functions, refer to page 44.

### Repeating an instruction

To repeat the last voice instruction:



or press



on the steering wheel briefly.  
Programing button functions, refer to page 44.

### Suppressing voice instructions

To prevent the navigation system from interrupting other audio sources, such as a news program or traffic bulletin, you can deactivate the voice instructions.

During an instruction, press



or press



on the steering wheel briefly.  
Programing button functions, refer to page 44.

### Adjusting volume

You can adjust the volume of the voice instructions for each specific key:

- To repeat the last voice instruction, if required:



or press



on the steering wheel briefly.

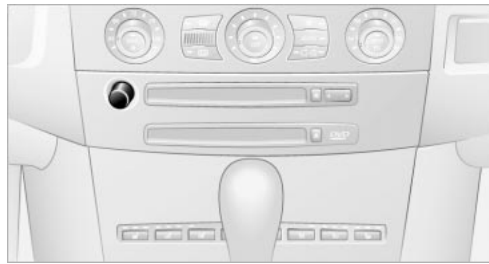

MAN02716DMA

- Turn the button during an instruction to select the desired volume.

The navigation system's voice guidance will continue to issue instructions at this volume level, even if the radio is set to minimum volume.

### Blocking sections of a route

During destination guidance you can revise the navigation system's route recommendations to avoid particular stretches of road. Enter the number of miles/kilometers that you want to travel before returning to the original route.

Control Center, for principle details, refer to page 16: تلفن شبانه روزی

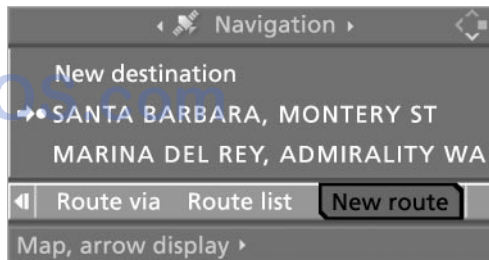

MAN00971UEA

- Select "New route" and press the controller
- Turn the controller to enter the desired number of miles/kilometers and press the controller.

To exit from the menu without changing the route:

Select  and press the controller

- "Calculate" is used to recalculate the route.

## Traffic information

### Calling up traffic information

Control Center, for principle details, refer to page 16:

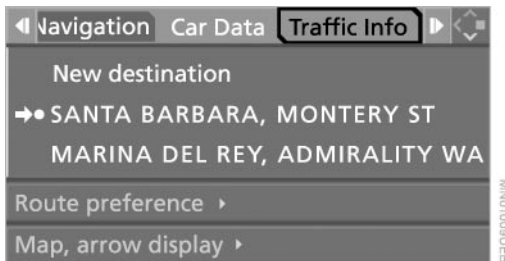

1. Select "Traffic Info" and press the controller. A list of the current traffic obstructions appears on the Control Display
2. If appropriate, select an entry and press the controller. Detailed information on the traffic obstruction is listed.

To exit the menu:

Select and press the controller.

### Bypass traffic congestion

1. Select "Detour" and press the controller
2. Select "Yes" and press the controller.

The navigation system determines a new route that bypasses the traffic congestion and then returns to the original route.

## Terminating/continuing destination guidance

Control Center, for principle details, refer to page 16:

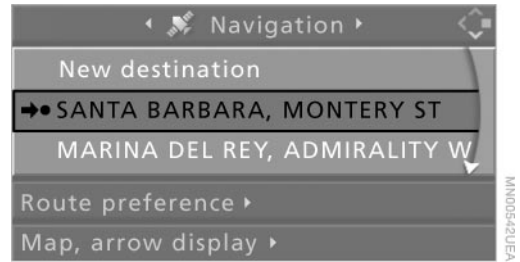

indicates the current destination.

1. Select the current destination and press the controller
2. Select "Start guidance" and press the controller. is displayed when the destination guidance is terminated.

The system suspends active destination guidance, including voice instructions, until reactivated.

When you park the vehicle before reaching the entered destination, upon restarting you will see the question "Continue guidance to dest.?". "Yes" switches the destination guidance on again.

This menu item cannot be selected using the voice command system.



# What to do if ...

## What to do if ...

- ▷ you request the current position of your vehicle, but do not receive a precise display?

The system is unable to receive enough GPS signals at your current position owing to obstructions, your position is not yet available on your navigation CD/DVD, or the system is in the process of calculating your position. As a rule, portable communications GSM/GPS reception is guaranteed under a clear sky

- ▷ the destination guidance does not adopt a destination?  
The data of the destination is not stored on the navigation CD/DVD that is loaded. Select a destination that is as close as possible to the original

- ▷ the destination guidance does not adopt an address without the street name?  
On the navigation CD/DVD, no downtown area can be determined for the city or town entered. Enter any street, or a destination such as the railway station etc., then start the destination guidance

- ▷ you want to enter a destination for the destination guidance system, but it is not possible to select the letters for your desired entry?  
The destination data is not recorded on the navigation CD/DVD that is loaded. In this case, the system will not offer you any letters to choose from. Select a destination that is as close as possible to the original

- ▷ the system stops furnishing directions on which way to turn as you approach intersections?  
You are driving in an area that has not yet been completely recorded on the navigation CD/DVD. Instead of an arrow indicating a turn, you will see an arrow which indicates the general direction of

your planned route. Or you have left the recommended route and the system requires a few seconds to calculate a new recommended route

- ▷ the battery has been disconnected?  
It will take approx. 15 minutes for the system to resume operation.



# امداد خودرو فارما

تلفن شبانه روزی: ۰۲۱-۸۸۸۶۲۰۸۵

[FarmaSOS.com](http://FarmaSOS.com)

## Entertainment

All operating options for radio and CD, and the tone settings, are described in this chapter.

امداد خودرو فارما

تلفن شبکۀ روزی: ۰۲۱-۸۸۸۶۲۰۸۵

FarmaSOS.com

# On/off, tone

Depending on the equipment options you have chosen, the following audio sources are available:

- ▷ Radio Business
- ▷ CD player
- ▷ CD changer.

The following section summarizes the common controls and setting options for the audio sources. Thereafter, the individual audio sources are described in detail.

## Controls

The audio sources can be operated using:

- ▷ The center console
- ▷ The Control Center
- ▷ Buttons on the steering wheel, refer to page 11.

### Operation using the center console

The layout of the buttons can vary depending on your vehicle's equipment.

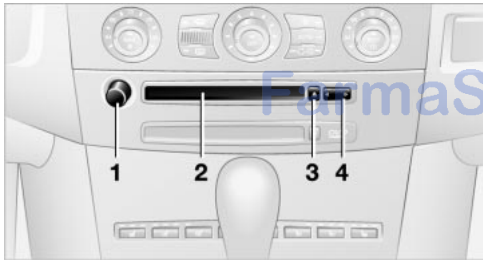

- 1 To operate audio sources
  - ▷ Press: switching on/off. The system selects the last audio source used, radio or CD
  - ▷ Turn: adjusting volume
- 2 Drive for audio CD
- 3 Eject CD
- 4 Station scan/track search
  - ▷ Change the station
  - ▷ Select music track for CD

### Operation using the Control Center

Control Center, for principle details, refer to page 16:

#### MENU

1. Open the start menu by pressing the button



2. Move the controller backwards to open "Entertainment".



- ▷ "FM" and "AM"  
Selecting waveband, storing and calling up stations
- ▷ "WB"  
Opening Weather Band station
- ▷ "SAT"  
Selecting satellite radio
- ▷ "CD"  
Selecting CD player or CD changer
- ▷ "Set"  
Updating stations with best reception, storing stations, setting the tone, playing stations or tracks.

## Operating temperatures



The system is configured for operating temperatures of 5 °F / -15 °C to 140 °F / +60 °C. Outside this temperature range, malfunctions can occur. ◀

## Care instructions

You can find everything you need to know on this topic by consulting the separate Caring for your vehicle brochure.

## Switching on/off

Press button **1**, refer to page **130**.

## Adjusting the volume

### Adjusting the volume for audio sources

The setting is made in dependence on a specific key.

Turn button **1** until the desired volume has been reached.

## Tone control

You can change the following tone settings in dependence on a specific key:

- ▷ Treble
- ▷ Bass
- ▷ Balance: Right/left volume balance
- ▷ Fader: Front/rear volume balance
- ▷ Speed volume: Raises the volume with increasing speed
- ▷ LOGIC7 spatial sound\*: Improvement in spatial acoustics in all frequency ranges
- ▷ Equalizer\*: Setting individual frequency ranges to include spatial acoustics

- ▷ Reset: Resets the tone settings to their standard default settings.

## Changing tone

Control Center, for principle details, refer to page **16**:

### MENU

1. Open the start menu by pressing the button



2. Open the **i** menu by pressing the controller

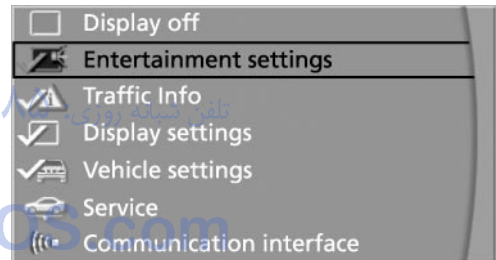

3. Select "Entertainment settings" and press the controller
4. Select "Audio" and press the controller.

The tone settings can also be selected if you have opened "Entertainment": Select "Set" and then "Audio" and press the controller each time.

### Treble and bass

1. Select "Treble / Bass" and press the controller



2. Move the controller to the left or right to select "Treble" or "Bass"
3. Turn the controller. The adjustment is adopted; the field can be changed.

### Balance and fader

1. Select "Balance / Fader" and press the controller

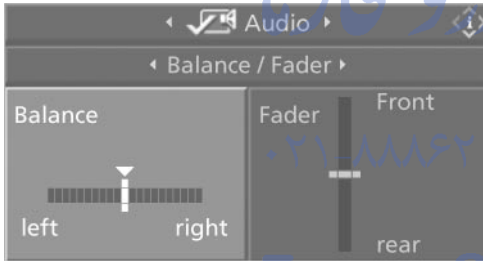

2. Move the controller to the left or right to select "Balance" or "Fader"
3. Turn the controller. The adjustment is adopted; the field can be changed.

### Speed-dependent volume

1. Select "Speed volume" and press the controller

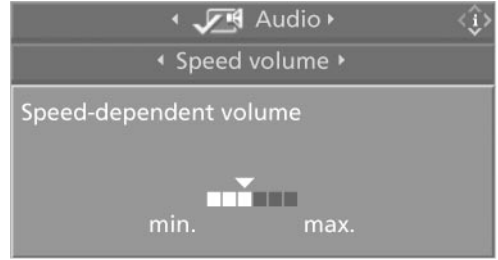

2. Turn the controller to make the adjustment
3. Press the controller. The adjustment is adopted; the field can be changed.

### Spatial sound effect Professional LOGIC7\*

1. Select "LOGIC7" and press the controller

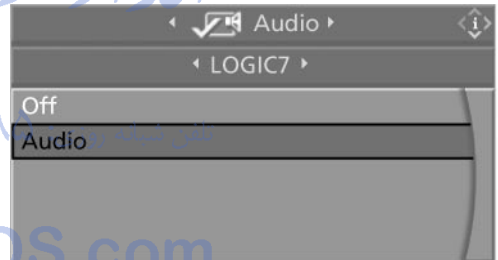

2. Select "Audio" and press the controller. LOGIC7 spatial sound is switched on.

To switch off LOGIC7 spatial sound:  
Select "Off" and press the controller.

LOGIC7 and the LOGIC7 logo are registered trade marks of Lexicon, Inc., a company of the Harman International Group.

## Equalizer\*

1. Select "Equalizer" and press the controller



2. Move the controller to the left or right to select the desired frequency range
3. Turn the controller. The adjustment is adopted; the field can be changed.

## Resetting the tone settings

You can reset all tone settings except "Speed volume" to the standard default settings.

1. Open the **i** menu
2. Select "Entertainment settings" and press the controller
3. Select "Audio" and press the controller



4. Select "Reset" and press the controller.

# Radio

Your radio provides reception of the FM and AM wavebands.

## Listening to the radio

To switch on the radio:

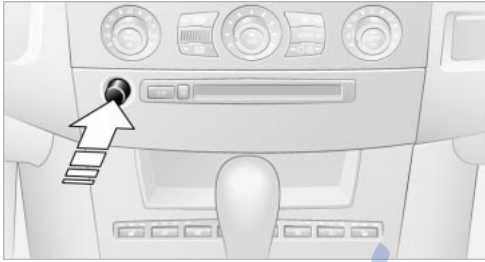

Press the button.

Control Center, for principle details, refer to page 16:

### MENU

1. Open the start menu by pressing the button



2. Move the controller backwards to open "Entertainment"



3. Select "FM" or "AM" and press the controller.

Stations are shown on the Control Display on the basis of various selection criteria, e.g. "Presets"



4. Change stations by turning the controller.

If no station is displayed, update the stations with the best reception, refer to page 135.

You can choose from the following selection criteria:

- ▷ Autostore:  
The six strongest stations, refer to page 135
- ▷ "Presets":  
Twelve stations you have previously stored, refer to page 136.



To switch between the different selection criteria of stations:

1. Move the controller forwards to change the field



2. Select the selection criterion and press the controller.

### Changing stations using buttons in the center console



Press to the desired direction briefly. The system switches to the next station.

### Scanning and selecting stations

The scan search feature automatically plays a brief sample from each station in the selected waveband.

Control Center, for principle details, refer to page 16:

1. Select "FM" or "AM" and press the controller
2. Press the controller to display a list of additional menu items



3. Select "Scan" and press the controller. The scan search starts
4. Select a station: Press the controller again, select

"Scan" and press the controller.

This cancels the scan search, and the radio remains on the current station.

Buttons in the center console:

1. To start scan:



Press for longer. The scan search starts.

2. To select a station:



Press.

### Manual station selection

You look for a certain frequency.

Control Center, for principle details, refer to page 16:

1. Select "FM" or "AM" and press the controller
2. Move the controller forwards to change the field
3. Select "Manual" and press the controller

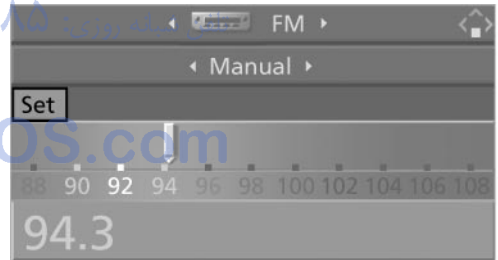

4. Turn the controller until the desired frequency is selected.

### Updating the stations with the best reception

If you are on a longer journey and leave the transmission range of the stations originally set, you can update the list of stations with the best reception from the AM or FM waveband.

Control Center, for principle details, refer to page 16:

1. Select "FM" or "AM" and press the controller
2. Move the controller forwards to change the field
3. Select "Autostore" of the desired waveband and press the controller
4. Press the controller to display a list of additional menu items

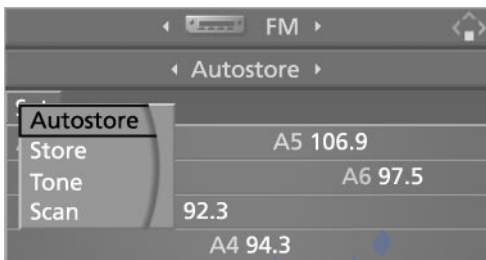

5. Select "Autostore" and press the controller. The list of stations with the best reception is updated; the frequencies of the stations are displayed.

### Manual tuning

You can listen to stations that are received in addition to those displayed.

Control Center, for principle details, refer to page 16:

1. Select "FM" or "AM" and press the controller
2. Move the controller forwards to change fields
3. Select "Manual" and press the controller

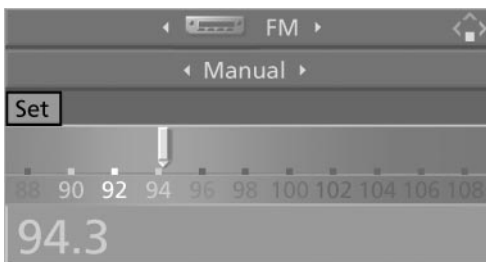

Buttons in the center console:

4. To start scan:



Maintain pressure on the button for several seconds.

The scan mode begins with the currently selected frequency.

The system plays a brief sample from each radio station.

To stop the station scan at the desired frequency or station:



Press button.

### Storing stations

The setting is made in dependence on a specific key.

Control Center, for principle details, refer to page 16:

1. Select "FM" or "AM" and press the controller
2. Move the controller forwards to change the field
3. Select the selection criterion and press the controller
  - ▷ "Manual"
  - ▷ Autostore of the waveband
4. Select the desired station
5. Press the controller to display a list of additional menu items



6. Select "Store" and press the controller. "Presets" is displayed
7. Turn the controller until the desired memory location is selected.

The number of the memory location appears beside the name or frequency of the station.

Press the controller to store the station.



The previous selection criterion is displayed again after a short time.

### Radio Data System RDS

The Radio Data System RDS broadcasts additional information in the FM waveband. RDS stations have the following properties:

- ▷ In the case of broadcasting networks that transmit over a number of frequencies, there is an automatic switch to the frequency with the best reception quality
- ▷ If the reception conditions are good, the station names are shown on the Control Display. If the reception is weak or disrupted, it can take some time before the station names appear.

## Weather Band\*

Weather Radio is a service of the National Oceanic and Atmospheric Administration – NOAA – of the U.S. Department of Commerce. Weather messages are repeated every four to six minutes and are routinely revised every one to three hours, or more frequently if needed. Most of the stations operate 24 hours daily. During severe weather, National Weather Service forecasters can interrupt the routine weather broadcasts and substitute special warning messages. If you have a question concerning NOAA Weather Radio, please contact your nearest National Weather Service Office, or write to National Weather Service – Attn: W/OM11–, National Oceanic and Atmospheric Administration, 1325 East-West Highway Silver Spring, MD. 20910.

### Selecting Weather Band

Control Center, for principle details, refer to page 16:

1. Select "WB" and press the controller

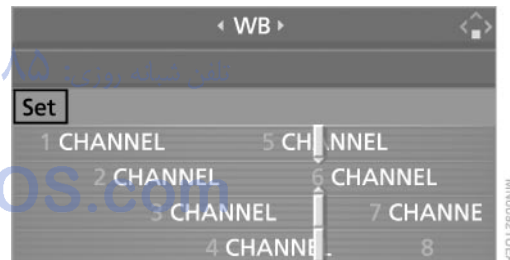

2. Select the Weather Band station and press the controller.

The Weather Band station may not be available in some regions.

## Satellite radio\*

You can receive up to 100 different channels with high tone quality.

You can listen to one of these channels free of charge at any time to obtain a first impression. The channel is marked with .

To listen to additional channels of your choice, you must have these channels activated.



You may experience signal drops and muting events related to this new technology. ◀

### Activating channels

Control Center, for principle details, refer to page 16:

#### MENU

1. Open the start menu by pressing the button



2. Move the controller backwards to open "Entertainment"



3. Select "SAT" and press the controller

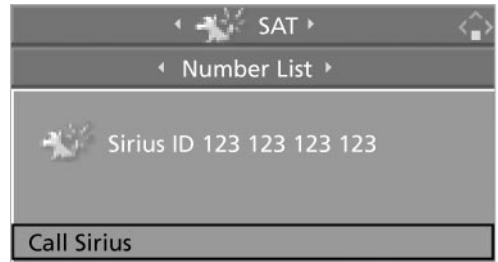

4. To enable, select "Call Sirius" and press the controller
5. Turn the ignition key to position 0 and wait at least 5 minutes.

### Selecting and storing channel

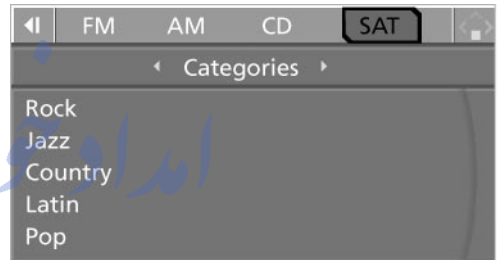

1. Select "SAT" and press the controller. Channels are shown on the Control Display on the basis of various criteria

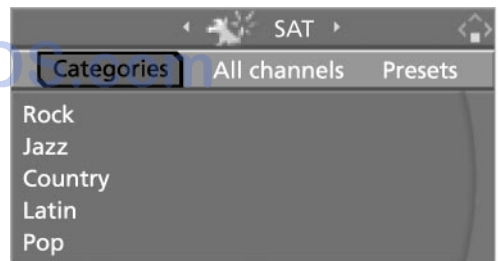

2. Select the menu item and press the controller:
  - ▷ "Presets":  
Up to twelve channels you have stored
  - ▷ "All channels"
  - ▷ "Categories":  
All channels by category, e.g. news, jazz



MAN0119UEA

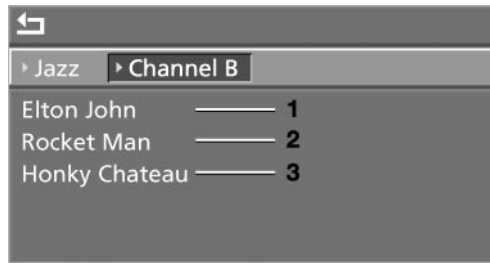

MAN0120UEA

- If "Categories" was selected: Select the desired category and press the controller. The channels of this category are displayed

- Artist
- Track
- Album

### Storing channel

- Select desired channel
- Press the controller to display a list of additional menu items

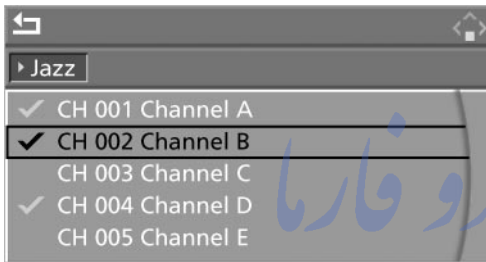

MAN0120UEA

- Select a channel marked with this symbol
- Press the controller to display a list of additional menu items



MAN0120UEA

- Select "Store" and press the controller. "Presets" is displayed



MAN0121UEA

- Select "Play" and press the controller.

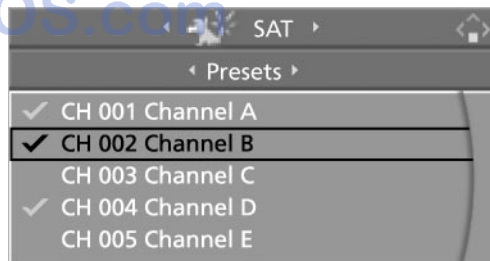

MAN0120UEA

- Turn the controller to select a memory location and press the controller.

The channel is stored; the previous criterion appears after a short time.

### Additional information

The name of the channel and additional information on the current track are displayed, e.g. the name of the artist.

## Changing channel using buttons in the center console



Press to the desired direction briefly.  
The system switches to the next channel.

### Notes

When there is a signal blockage or the transmission is suspended momentarily for more than 4 seconds, a message appears on the Control Display.



Service may be interrupted or unavailable for specific reasons such as environmental or topographic conditions and others that Satellite Radio cannot directly control.

Signal may not be available under tunnels, in parking garages, next to tall buildings, nearby trees with dense foliage, nearby mountains or other possible strong sources of radio interference.

Service should resume normally after the source of signal unavailability has been cleared. ◀

تلفن شبانه روزی: ۰۸۵-۸۸۸۶۲-۰۲۱

FarmaSOS.com

# CD Compact Disc

## Listening to CDs

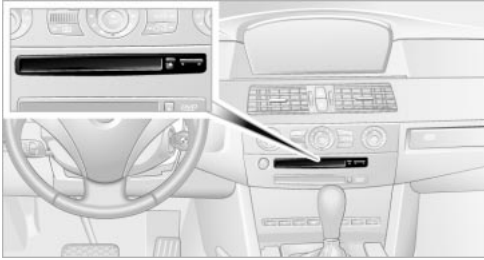

Insert the CD.

Playback starts automatically.

Hold CDs by the edges; do not touch the reflecting CD memory surface.

To start playback when there is already a CD in the drive:

Control Center, for principle details, refer to page 16:

### MENU

1. Open the start menu by pressing the button



2. Move the controller backwards to open "Entertainment"
3. Select "CD" and press the controller
4. On vehicles with a CD changer, select "CD" and press the controller.



To eject the CD:



Press the button in the center console.

The CD/DVD emerges slightly from the drive.

## Selecting a track

Buttons in the center console:

Select the direction:



Press the button repeatedly, continuing until you reach the desired track.

The CD will start play at the track selected. The track is displayed on the Control Display.

Control Center, for principle details, refer to page 16:



Select a track by turning the controller.

## Repeating a track

Control Center, for principle details, refer to page 16:



1. Select "Set" and press the controller to display a list of additional menu items
2. Select "Repeat" and press the controller.

The selected track on the CD is repeated.

To cancel the repetition:

- ▷ Press the controller, select "Repeat" and press the controller
- ▷ Select another function using the Control Center.

## Sampling and selecting tracks, scan

The system automatically plays a brief sample from each of the tracks on the CD, one after the other.

Control Center, for principle details, refer to page 16:

1. Select "Set" and press the controller to display a list of additional menu items
2. Select "Scan" and press the controller
3. Select track:  
Press the controller again, select "Scan" and press the controller.  
The Scan function is interrupted and the track continues playing from the point at which it was interrupted.

## Random play sequence

The music tracks on the CD are played in a random sequence.

Control Center, for principle details, refer to page 16:

1. Select "Set" and press the controller to display a list of additional menu items
2. Select "Random" and press the controller.

To cancel the random mode:

- ▷ Press the controller, select "Random" and press the controller
- ▷ Select another function using the Control Center.

## Fast forward/reverse

Buttons in the center console:

1. Select the direction:



Press and hold the button. The tracks can be heard, but the tone is distorted

2. To interrupt the fast forward/reverse function, release the button.

The CD will start play at the point selected.

The track is displayed on the Control Display, refer to page 18.



## Malfuctions

 The BMW CD player is a Class 1 laser product. Do not operate the system if the cover is damaged, otherwise severe eye damage can result.

Always refer repair and maintenance operations to qualified technicians.

With self-recorded CDs, labels applied later can become detached during playback due to the development of heat and cause irreparable damage to the device. ◀

 CDs with copy protection devices cannot be played on your CD player or only with certain restrictions. These CDs differ from the CD Audio Standard Red Book, on the basis of which all CD players and changers are designed. In this case, please contact the CD dealer or manufacturer.

You may experience playback problems, such as skips, when using CDs that you have copied at home.

If the display fails to detect a CD that you have loaded in the drive, check to ensure that the CD has been inserted correctly and inspect it for signs of defects.

High levels of humidity inside the system can condense on the laser's scan lens and temporarily prevent it from reading the CD. ◀

FarmaSOS.com

# CD changer\*

## CD magazine

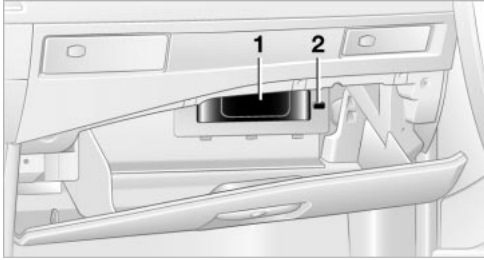

The BMW CD changer for six CDs is installed in the glove compartment.

### Removing the CD magazine

To load or remove CDs from the CD magazine you must first remove it from the CD changer:

1. Press button 2
2. The CD magazine 1 is ejected and can be removed.

### Loading/removing CDs from the CD magazine



When loading or removing CDs, remember to grasp them on the edge, taking care to avoid touching the reflecting CD memory surface.

#### Loading:

Insert the CD in a CD slot with the desired number with the label side on top.

#### Removing CDs:

Pull out the desired drawer, refer to arrow, and remove the corresponding CD.

## Inserting the CD magazine

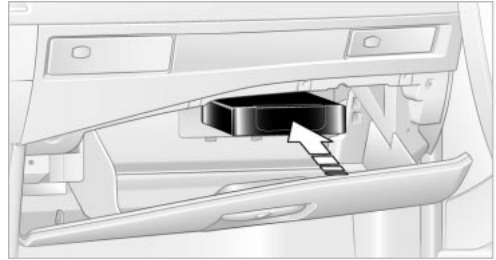

Ensure that the arrow symbol is pointing upwards toward the CD changer and slide the magazine all the way in.

The CD changer automatically reads in the loaded CDs and is then ready for operation.

## Listening to CDs

1. Insert the CD magazine

Control Center, for principle details, refer to page 16:



2. Open the start menu by pressing the button



3. Move the controller backwards to open "Entertainment"
4. Select "CD" and press the controller. The CD magazine's load status is indicated on the Control Display

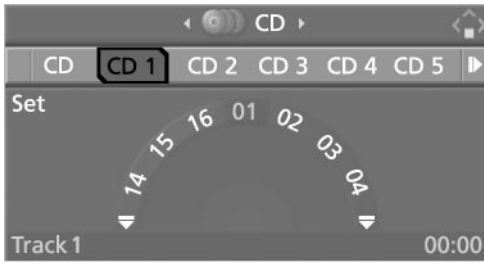

5. Select the CD and press the controller. The system will continue play at the point on the CD at which play was interrupted. At the end of the last track, the next CD will be selected.

If new CDs have been placed in the CD magazine, playback starts with the lowest CD, e.g. CD 1, track 1.

## Selecting a track

Buttons in the center console:

Select the direction:



Press the button repeatedly, continuing until you reach the desired track on the current CD.

The CD will start play at the track selected. The track is displayed on the Control Display.

Control Center, for principle details, refer to page 16:



Select a track by turning the controller.

## Repeating a track

Control Center, for principle details, refer to page 16:

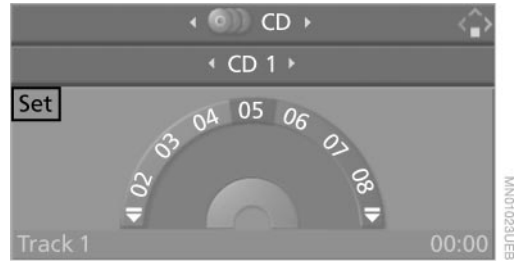

1. Select "Set" and press the controller to display a list of additional menu items
2. Select "Repeat" and press the controller.

The current track on the CD is repeated.

To cancel the repetition:

- ▶ Press the controller, select "Repeat" and press the controller
- ▶ Select another function using the Control Center.

## Sampling and selecting tracks, scan

The system automatically plays a brief sample from each of the tracks on the current CD, one after the other.

Control Center, for principle details, refer to page 16:

1. Select "Set" and press the controller to display a list of additional menu items
2. Select "Scan" and press the controller
3. Select track:

Press the controller again, select "Scan" and press the controller.

The Scan function is interrupted and the track continues playing from the point at which it was interrupted.

## Random play sequence

In this mode, the music tracks on the current CD are played in a random sequence. Control Center, for principle details, refer to page 16:

1. Select "Set" and press the controller to display a list of additional menu items
2. Select "Random" and press the controller.

To cancel the random mode:

- ▷ Press the controller, select "Random" and press the controller
- ▷ Select another function using the Control Center.

## Fast forward/reverse

Buttons in the center console:

1. Select the direction:



Press and hold the button. The tracks can be heard, but the tone is distorted

2. To interrupt the fast forward/reverse function, release the button. The system will continue play at the point on the CD at which the button was released.

The track is displayed on the Control Display, refer to page 18.

## Malfunctions



The BMW CD changer is a Class 1 laser product. Do not operate the system if the cover is damaged, otherwise severe eye damage can result.

Always refer repair and maintenance operations to qualified technicians.

With self-recorded CDs, labels applied later can become detached during playback due to the development of heat and cause irreparable damage to the device. ◀



CDs with copy protection devices cannot be played on your CD changer or only with certain restrictions. These CDs differ from the CD Audio Standard Red Book, on the basis of which all CD players and changers are designed. In this case, please contact the CD dealer or manufacturer.

You may experience playback problems, such as skips, when using CDs that you have copied at home.

If the display fails to detect a CD that you have loaded in the magazine, check to ensure that the CD has been inserted correctly and inspect it for signs of defects.

High levels of humidity inside the system can condense on the laser's scan lens and temporarily prevent it from reading the CD. ◀

# امداد خودرو فارما

تلفن شبانه روزی: ۰۲۱-۸۸۸۶۲۰۸۵

**FarmaSOS.com**



# امداد خود و فارما

تلفن شبانه روزی: ۰۲۱-۸۸۸۶۲۰۸۵

[FarmaSOS.com](http://FarmaSOS.com)

## Communications

This chapter summarizes how you operate your BMW portable phone via the Control Center or voice control and how you use BMW Assist or TeleService.

امداد خودرو فارما

تلفن شبانه روزی: ۰۲۱-۸۸۸۶۲۰۸۵

FarmaSOS.com

# Telephoning

## Safety notice

### For your own safety

A car phone makes life more convenient in many ways, and can even save lives in an emergency. While you should consult your portable phone's separate Owner's Manual for a detailed description of safety precautions and information, we request that you direct your particular attention to the following:

### Adjustments

 To avoid posing a danger to yourself and other road users, never adjust the system settings unless your vehicle is completely stationary. ◀

### Using the phone in your vehicle

 Using a portable phone to make and receive calls while driving is now illegal in virtually every country in the world. Always use your hands-free unit, or stop your vehicle in an area where you will not pose a safety hazard to other road users. ◀

### Vehicles and portable phones

 Do not use your phone from within a garage, or near an open hood. The air in these areas could contain fuel vapors, and the portable phone might generate sparks that could result in burns.

This same precaution applies to open luggage compartment lids on vehicles equipped for operation using natural gas or hydrogen, and to all vehicles with luggage compartment-mounted batteries. ◀

### Antenna

 When using the phone, ensure that all persons in the area are at least 20 in/50 cm from the antenna. Never use your BMW portable phone if the antenna is damaged. Contact between your skin and a damaged antenna can result in minor

burns.

If the antenna is damaged, have it replaced immediately. ◀

### Special environmental conditions

 Always switch off your BMW portable phone in areas where blasting work is being conducted with explosives. The phone signals could potentially act as a high-frequency transmitter and set off explosions.

Always switch off your BMW portable phone in areas where an increased explosion danger is present. This category includes filling stations along with fuel and chemical storage depots, etc., and all areas in which the air can contain fuel, chemicals or metal particles. Under these conditions, your BMW portable phone could conceivably generate sparks that could lead to a fire or explosion. Always observe all legal regulations governing the use of portable phones in the vicinity of filling stations, chemical factories and other areas where an explosion potential exists. Never use the BMW portable phone in aircraft; do not use this portable phone in hospitals, care centers or at other locations where medical equipment may be in operation, such as accident sites, etc.

Your service provider can furnish you with more detailed information on legal regulations governing the use of your phone. ◀

### Medical equipment

 Portable phones can generate interference capable of preventing hearing aids and cardiac pacemakers from operating correctly. If you or any occupant of the vehicle will be using such equipment, consult a physician or the manufacturer of the equipment to determine whether it is adequately shielded against high-frequency energy. ◀



## Batteries

 Never attempt to disassemble your BMW portable phone or its battery. Use only approved battery types – the wrong battery can destroy your portable phone.

To avoid possible short circuits, after removing a battery you should never allow it to come into contact with metallic surfaces of any kind. ◀

## Disposing of used batteries

 Return used batteries to a recycling collection point or to your BMW center. ◀

## Care instructions

You can find useful information on caring for your portable phone in the separate portable phone Owner's Manual and in the separate Caring for your vehicle brochure.

## Controls

You can operate the BMW portable phone\* using:

- ▷ The steering wheel, refer to page 11
- ▷ The Control Center, refer to page 152
- ▷ The voice control, refer to page 157.

You can use the car phone via the hands-free unit for BMW Assist calls.

The Control Display indicates which telephone you are using to establish a connection.

## Telephoning with the car phone: BMW Assist calls

You can use the car phone via the hands-free unit for BMW Assist calls.

 The car phone must have been enabled prior to initial use. In this connection, please contact your BMW center. ◀

## Starting the BMW portable phone\*

Before starting off, place the BMW portable phone in the cradle. If you are making a call using the car phone, you can only use the BMW portable phone once you have terminated this call.

## Inserting the portable phone

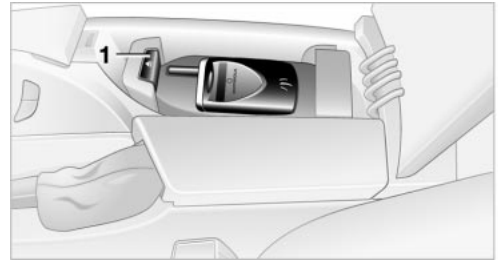

1. Press button 1
2. If necessary, remove the protective cap from the antenna connector on the rear of the portable phone
3. Insert the portable phone with the antenna fully retracted
4. Press the cradle downwards.

## Removing the portable phone

Press button 1.

 For information on operating your portable phone, please consult the separate Owner's Manual. ◀

## Hands-free unit



The hands-free microphones are located on the headlining.

The hands-free unit is activated whenever you establish or receive a call using:

- ▷ The buttons on the steering wheel
- ▷ The Control Center
- ▷ Voice control.

To continue a call on the portable phone using hands-free unit:

Insert the portable phone with the lid opened in the cradle.

To continue a call on the hands-free unit using the portable phone:

Take the portable phone with the lid opened out of the cradle.

The call is ended as soon as you take the phone from the cradle with a closed lid.

### Volume adjustment

You can adjust the volume for the hands-free unit for each individual key:

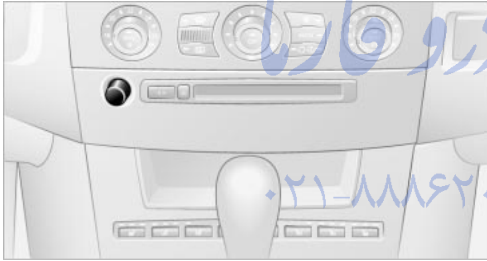

Turn the button during a call to select the desired volume.

The hands-free unit will remain at this volume level, even if the other audio sources are set to minimum volume.

## Operation using the Control Center

You can use the following functions via the Control Center:

- ▷ Enter unlock code with portable phone engaged
- ▷ Dial phone number
- ▷ Phone book with portable phone engaged
- ▷ Top-8 with portable phone engaged

- ▷ Repeat dialing
- ▷ Display accepted calls
- ▷ Display missed calls
- ▷ Text messages/SMS with portable phone engaged.

Control Center, for principle details, refer to page 16:

1. Turn the ignition key to position 2

### MENU

2. Open the start menu by pressing the button



3. Move the controller forwards to open "Communication".

### Entering unlock code

If, after placing the BMW portable phone in the cradle, you are requested by a message from the Control Display to enter the unlock code:

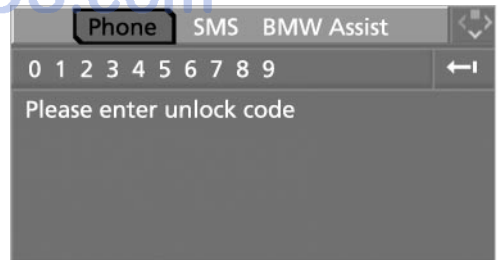

1. Select "Phone" and press the controller
2. To enter the unlock code: select digits individually and press the controller. Each digit of the unlock code is displayed on the Control Display with an asterisk.

To delete the last digit:  
Turn the controller to the right to select  
←| and press the controller

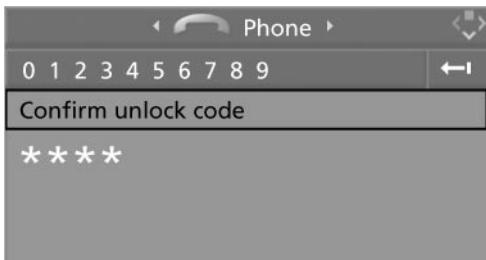

MAN00923UEB

3. Select "Confirm unlock code" and press the controller.

### Receiving calls

If you have the phone number of the caller stored in the phone book and the phone number is transmitted, the name of the entry is displayed.

### Accepting a call



MAN00923UEA

Select "Accept" and press the controller.

### Rejecting a call

Select "Reject" and press the controller.  
The caller is diverted to your mailbox if this has been activated.

## Making a call

### Dialing a phone number



MAN00931UEA

1. Select "Phone" and press the controller
2. Select "Dial" and press the controller
3. To enter the phone number: select digits individually and press the controller. Always enter the complete phone number consisting of national dialing code, area code, and phone number.

To delete the last digit:  
Move the controller to the right to select  
←| and press the controller

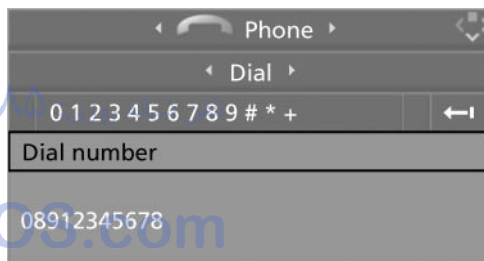

MAN00923UEA

4. Select "Dial number" and press the controller.

## Ending call

1. Select the phone number and press the controller



2. Select "End call" and press the controller.

## Phone book

After placing the portable phone in the cradle, the phone book is transferred from the portable phone into the vehicle. Loading the phone book can take several minutes. The phone book is available as long as the portable phone is engaged.

## Dialing from the phone book

1. Select "Phone" and press the controller

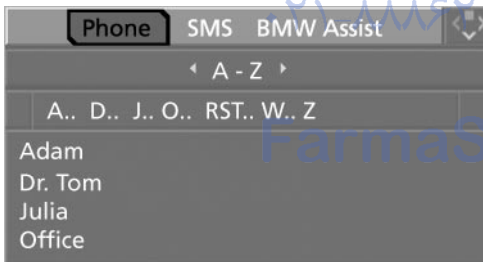

2. Select "A - Z" and press the controller: The entries of the phone book of the portable phone are displayed on the Control Display; they are sorted alphabetically.

To run a targeted search for an entry, select the first letter of the entry and press the controller.

The first entry that starts with this letter is displayed

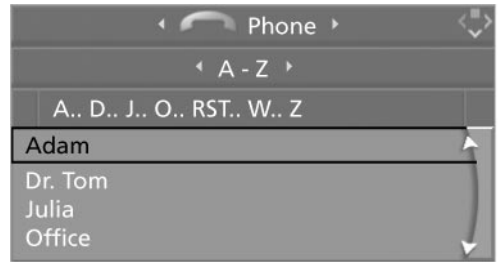

3. Select the desired entry and press the controller
4. Select "Call" and press the controller. The system dials the number.

If different phone numbers are stored in the portable phone under one name, e.g. office and home, the name is shown once for each phone number.

To display the phone numbers:

1. Select "Edit" and press the controller
2. Select and press the controller.

## Adding digits to phone numbers

You can add other digits to a phone number stored in the phone book, e.g. to call a specific extension:

1. Select "Phone" and press the controller
2. Select "A - Z" and press the controller
3. Select the desired entry and press the controller
4. Select "Edit" and press the controller
5. To supplement the phone number: Select digits individually and press the controller
6. Select "Dial number" and press the controller.

## Lists

Your phone can store phone numbers you have dialed and missed calls in lists. If the caller is entered in the phone book, the name of the entry is displayed instead of the phone number.

You can select the desired subscriber from the list and establish the connection.

Four lists are available:

- ▷ "Top 8".  
The eight numbers that you call most frequently from the list "A - Z" are automatically stored in the "Top 8" list. The number called most often appears at the top of the list
- ▷ "Redial".  
The last eight phone numbers you have dialed are automatically stored. The last number dialed is at the top of the list
- ▷ "Received calls".  
The phone numbers of the eight calls last accepted are stored if the phone number of the caller is transmitted
- ▷ "Missed calls".  
The phone numbers of the last eight calls not accepted are stored if the phone number of the caller is transmitted.

### Dialing from a list

To select an entry and establish a connection:

1. Select "Phone" and press the controller



2. Select the list and press the controller:

- ▷ "Top 8", with the portable phone engaged
- ▷ "Redial"
- ▷ "Received calls"
- ▷ "Missed calls"



3. Select the desired entry and press the controller
4. Select "Call" and press the controller. The system dials the number.

### Deleting individual entries

1. Select the desired entry from the list and press the controller



2. Select "Delete" and press the controller.

The entry is deleted.

### Deleting the entire list

1. Select an entry from the list and press the controller

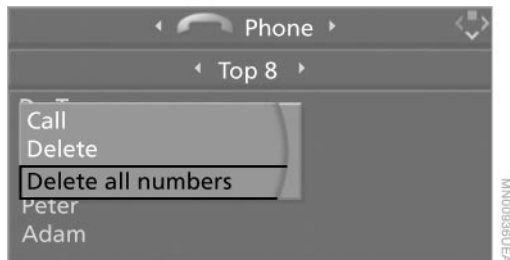

2. Select "Delete all numbers" and press the controller. The list is deleted.

## Touch tone dialing

Touch tone numbers are required for access to network services or to control devices, e.g. remote querying on an answering machine.

This function can only be used during an existing connection.

1. To establish a connection



2. Press the controller
3. Select "Keypad" and press the controller

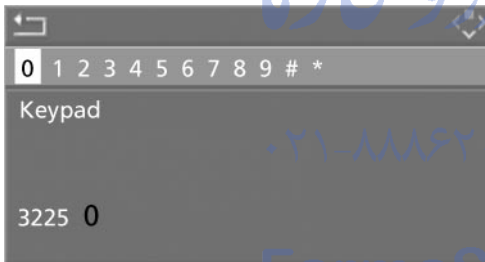

4. Select the desired digits and press the controller.  
Each digit is sent immediately.

## Text messages/SMS

Text messages/SMS are displayed as long as the portable phone is engaged.

The symbol  on the Control Display shows that you have received a new text message. It goes out as soon as there are no longer any unread text messages.

The number of text messages that can be stored depends on the memory capacity of your BMW portable phone.

## Displaying text messages/SMS

1. Select "SMS" and press the controller.  
The list of received text messages is displayed on the Control Display.  
The symbol  indicates unread text messages
2. Select the desired text message and press the controller.  
The text message is displayed.

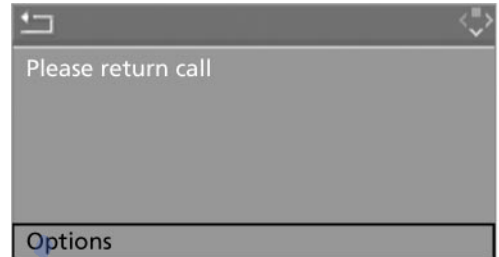

To close the text message:  
Move the controller forwards to select  and press the controller.

## Calling the sender

1. Select the desired text message and press the controller.  
The text message is displayed
2. Select "Options" and press the controller
3. Select "Call sender" and press the controller.  
The selected sender is called.

## Deleting text messages/SMS

1. Select the desired text message and press the controller.  
The text message is displayed
2. Select "Options" and press the controller
3. Select "Delete" and press the controller.  
The text message of the portable phone is deleted.

## Operation by voice control\*

### The concept

You can operate your phone without having to remove your hands from the steering wheel. The system operates on the basis of voice commands that you will learn easily after using them a few times. In addition, you are also supported by instructions or questions.

### Symbols used

-  ›...‹ Identifies voice commands.
- ››...‹‹ Identifies instructions generated by the voice command system.

### Voice commands

In ignition key position 2:

- Briefly press the  button on the steering wheel.  
A sound signal indicates operating readiness
- Speak voice commands.

### Dialing a phone number - an example

Start the dialog:

Briefly press the  button on the steering wheel.

Voice command	Response
›Dial number‹	››Please say the number‹‹
e.g. ›201 12 34 56 7‹	››201 12 34 56 7. Continue?‹‹
›Dial‹	››Dialing number‹‹

To have the system list the voice commands possible in each case:

 ›Help‹.

### Canceling operation via voice control

Briefly press the  button on the steering wheel or

 ›Cancel‹.

In dialogs where text of any kind can be spoken, e.g. a name, canceling is only possible using the  button. This is automatically interrupted when an incoming call is received.

### Voice commands

In addition to the commands described in this Owner's Manual, alternative commands are often possible for the same functions, e.g.:

 ›Dial name‹ or ›Name‹.

Digits from zero to nine are understood.

You can say each digit individually or group them into a sequence of three to five digits to accelerate the input.

تلفن شبانه روزی: ۰۸۵-۸۸۶۲۰۲۱

FarmaSOS.com

## Volume adjustment

You can adjust the volume for the instructions from the voice control for each specific key:



Turn the button during an instruction to select the desired volume.

The voice control will continue to issue instructions at this volume level, even if the other audio sources are set to minimum volume.

## First steps

### Switching on portable phone

☎ ›Switch on phone‹.

### Entering unlock code

You can protect your BMW portable phone against misuse with a four-digit unlock code.

- ☎ 1. ›Input Unlock Code‹.  
The dialog for entering the unlock code is opened
2. Speak unlock code
3. ›Send Unlock Code‹.

### Correcting unlock code

After the sequence of digits has been repeated by the system, the unlock code can be corrected.

- ☎ 1. ›Correct number‹.  
The block of digits is deleted
2. Say the new unlock code on request
3. ›Send Unlock Code‹.

## Deleting unlock code

☎ ›Delete number‹.

## Canceling the operation

☎ ›Cancel‹.

## Making a call

### Dialing a phone number

- ☎ 1. ›Dial number‹.  
The dialog for establishing a telephone connection is opened
2. Say the phone number.  
For telephone calls abroad, say ›Plus‹ and then the country code
3. ›Dial‹.  
The connection to the desired subscriber is established.

### Correcting the phone number

After the last spoken sequence of digits has been repeated by the system, you can delete this sequence of digits.

☎ ›Correct number‹.  
The digits are deleted.

The command ›Correct number‹ can be repeated as often as you like.

### Deleting input

›Delete‹ is used to delete all the digits entered so far.

## Voice phone book

You can create a voice phone book with up to 50 phone numbers and names. The names and phone numbers in the voice phone book are independent of the memory of your BMW portable phone.



## Storing an entry

An entry always consists of a name and phone number.

1. ›Save name‹.  
The dialog for storing a name is called up
2. Say the name and repeat entry upon request.  
The duration of the name in the phone book must not exceed approx. 2 seconds
3. Say the phone number upon request
4. To save the phone number: ›Save‹.

## Selecting an entry

The connection to the phone number of the selected entry is established

1. ›Dial name‹.  
The dialog for selecting an entry is opened
2. Say the name on request
3. Confirm the prompt with ›Yes‹.

## Reading out and selecting entries

You can have all the entries of your voice phone book read out in the order of input and select a certain entry to establish a connection:

1. ›Read phonebook‹.  
The dialog for reading the phone book is called up
2. ›Dial number‹ when the desired entry is read out.

## Repeat dialing

›Redial‹ dials the last phone number dialed.

## Deleting an entry

You can delete any entry from the voice phone book.

1. ›Delete name‹.  
The dialog for deleting an entry is called up
2. Say the name on request
3. Confirm the prompt with ›Yes‹.

## Deleting all entries

›Delete phonebook‹ deletes all entries in the phone book.

1. ›Delete phonebook‹.  
The dialog for deleting phone book is called up
2. Confirm the prompt with ›Yes‹
3. Confirm the repeated prompt with ›Yes‹.

امداد خودرو فارما

تلفن شبانه روزی: ۰۸۵ ۸۸۸۶۲۰۲۱

FarmaSOS.com

## Notes



The voice commands were available in English on going to print. Other languages are currently not available. ◀

### Important for voice input

Issue the commands fluently and at normal volume, avoiding excessive emphasis and pauses.

On vehicles with a phone, two microphones are installed near the interior rear-view mirror of your vehicle. Although the system is designed to filter out ambient noise, you can help ensure that your commands will be understood by observing the following instructions:

- ▷ Keep the doors, windows and glass roof closed to prevent interference from ambient noise
- ▷ Avoid other sources of noise in the vehicle while speaking, and ask other vehicle occupants to refrain from talking while you are using the system.

تلفن شبانه روزی: ۰۸۵-۸۸۸۶۲-۰۲۱

FarmaSOS.com

# TeleService\*, BMW Assist\*

## TeleService

TeleService opens up a new dimension for communication with BMW Service. The car phone can be used to transmit data on the service status of your vehicle or on legally prescribed inspections directly to your BMW center. This is the same data that is stored for CBS Condition Based Service in the ignition key. Your BMW center can then contact you, and you can make an appointment that suits you while you are still on the road. Your advantage here is that your BMW center can prepare in advance for the required maintenance work. The TeleService functions are country-specific. The data on the service status of your vehicle or on legally required inspections is transmitted on a country-specific basis either automatically before they fall due or simultaneously when you call any service partner you have chosen. Your BMW center will be glad to provide more detailed information.

## BMW Assist

BMW Assist is available to you if you have ordered this option at your BMW center or BMW customer information. This provides you with other services in addition to TeleService.

Many functions of BMW Assist depend on the individually agreed contract.

The subscriber agreement must be completed successfully before using the BMW Assist services.

## Requirements

The telephone is registered in a portable phone network that can transmit the services.

To transmit position data, the navigation system must be able to determine the position. In order to enable and update

TeleServices or BMW Assist, a GPS signal must be present.

**⚠** To avoid posing an unnecessary hazard, both to your own vehicle's occupants and to other road users: never attempt to make adjustments while operating the vehicle. ◀

## Enabling TeleService or BMW Assist

For you to be able to use the services of TeleService or BMW Assist, these must be enabled:

Control Center, for principle details, refer to page 16:

### MENU

1. Open the start menu by pressing the button



2. Open the **i** menu by pressing the controller
3. Select "Communication interface" and press the controller
4. Select "BMW Service settings" and press the controller
5. Move the controller forwards to change the field

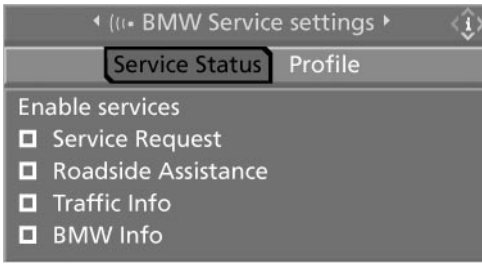

6. Select "Service Status" and press the controller
7. Select "Enable services" and press the controller.

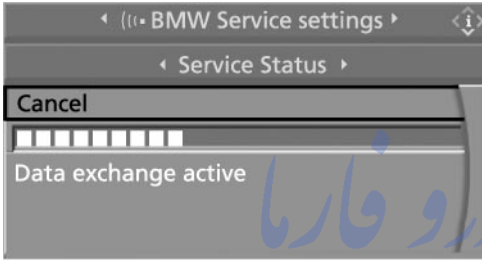

TeleService and, if applicable, BMW Assist is enabled; data exchange with the service center starts. Leave the ignition switched on.

Enabling takes a few minutes. The status is displayed on the Control Display. If you open another menu, the enable process continues to run in the background.

 displays the registered services.

## Services offered

### Automatic Service Notification\*

The data on the service status of your vehicle or on legally prescribed inspections is transmitted automatically directly to your BMW center prior to the due date.

You can check the current status of the Automatic Service Notification.

Control Center, for principle details, refer to page 16:

1. Open the **i** menu
2. Select "Service" and press the controller
3. Select "Service requirements" and press the controller

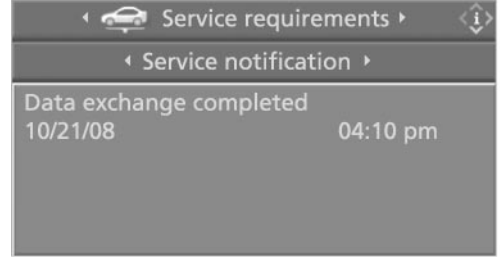

4. Select "Service notification" and press the controller.

### Setting up contact to Roadside Assistance of the BMW Group

You can contact Roadside Assistance of the BMW Group should you require help in the event of a breakdown.

Control Center, for principle details, refer to page 16: تلفن شبانه

1. Open the **i** menu
2. Select "Service" and press the controller
3. Select "BMW Service" and press the controller
4. Move the controller forwards to change the field



5. Select "Roadside Assistance" and press the controller. The current vehicle position is displayed



MAN01000UEE

6. Select "Start service" and press the controller.

In some countries, with BMW Assist enabled, the data of the CBS Condition Based Service and your position are transmitted simultaneously.

Voice communication to the Roadside Assistance service is set up.

### Setting up contact to your BMW center or the BMW Customer Relations

You can contact your BMW center, e.g. to arrange a service appointment.

For information related to your vehicle, call the BMW Customer Relations.

Control Center, for principle details, refer to page 16:

1. Open the **i** menu
2. Select "Service" and press the controller
3. Select "BMW Service" and press the controller
4. Move the controller forwards to change the field



MAN01029UEE

5. Select the desired service and press the controller

- ▷ To establish contact to BMW Service: "Service Request"  
BMW Service will call you back at the specified phone number, e.g. to make an appointment for service
- ▷ To establish voice contact to the BMW Hotline: "Customer Relations"

6. Select "Start service" and press the controller.  
Contact to the desired service will be established.

In some countries, with TeleService or BMW Assist enabled, the data of the Condition Based Service CBS are transmitted simultaneously.

### BMW Info\*

You can obtain information on important and useful new services and features.

Control Center, for principle details, refer to page 16:

1. Open "Communication"
2. Select "BMW Assist" and press the controller
3. Move the controller forwards to change the field
4. Select "BMW Info" and press the controller



MAN01074UEA

5. Display new messages:  
Select "Update status reports" and press the controller. The messages are transferred
6. Select the desired message and press the controller.

If you have received a message with a telephone number or an address, you can forward this to your portable phone or navigation system.

New messages are announced via SMS. For more detailed information, refer to page 156.

### Info Plus\*

This information service supplies you with a whole range of current, interesting information on request.

You can have telephone numbers and addresses transferred and directly dial the telephone number or copy the address to the destination guidance of the navigation system.

This option provides you with a current information service, e.g. in the following areas:

- ▷ Information on businesses  
e.g. florist, doctor
- ▷ Accommodations  
e.g. hotels, motels
- ▷ Mobility  
e.g. filling stations, airports, car rental, BMW dealers
- ▷ Eating and drinking  
e.g. restaurants, cafés, bars
- ▷ Current information  
e.g. movies playing, events.

Control Center, for principle details, refer to page 16:

1. Open "Communication"
2. Select "BMW Assist" and press the controller
3. Move the controller forwards to change the field
4. Select "Where to go?" and press the controller

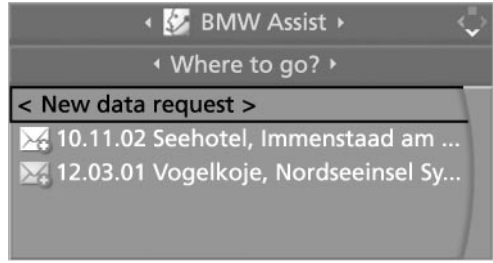

MAN01073UEA

5. If appropriate, select a message and press the controller.

### Display new message

Select "New data request" and press the controller.

You will be connected with an employee of the BMW Information Service. The desired information and the corresponding address can be requested by phone. These will be shown on the Control Display and can be copied to the portable phone or navigation system, e.g. telephone number or address of a hotel. Reservations can be made at many hotels directly by the BMW Information Service.

## Adapting TeleService or BMW Assist

### Displaying and updating services

If one of the following conditions is met, you should update the services of the TeleService or BMW Assist:

- ▷ You have changed the scope of the contractually agreed services
- ▷ The range of services of the offered services has been extended.

To update the services:

Control Center, for principle details, refer to page 16:

1. Open the **i** menu
2. Select "Communication interface" and press the controller
3. Select "BMW Service settings" and press the controller

4. Move the controller forward to change the field
5. Select "Service Status" and press the controller.

You will be informed about the current scope of TeleService or BMW Assist.

displays the registered services

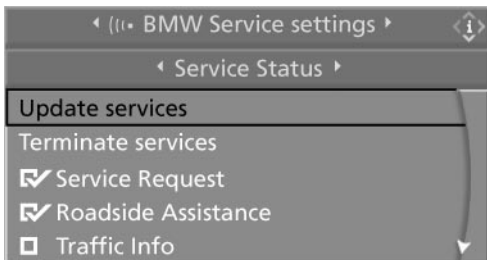

6. Select "Update services" and press the controller.

### Roaming

To align the services supported by home and foreign providers automatically, enable roaming:

1. Open the **i** menu
2. Select "Communication interface" and press the controller
3. Select "BMW Service settings" and press the controller
4. Move the controller forwards to change the field
5. Select "Profile" and press the controller
6. Select "Roaming" and press the controller.  is displayed when roaming is enabled.

Please note that additional costs can arise if you are located abroad.

### Terminating services

If you terminate the services, your vehicle will not be equipped to contact the BMW Assist call center. When an emergency call is started, the telephone connection to the general emergency number is established.

Control Center, for principle details, refer to page 16:

1. Open the **i** menu
2. Select "Communication interface" and press the controller
3. Select "BMW Service settings" and press the controller
4. Move the controller forwards to change the field
5. Select "Service Status" and press the controller
6. Select "Terminate services" and press the controller.

TeleService or BMW Assist is disabled in the vehicle. This does not involve any contractual termination.

Automatic Service Notification can be disabled separately; consult your BMW center.

Enable TeleService and, if applicable BMW Assist again to re-establish the connection.

### Displaying vehicle data

You can obtain a display of some of the selected data of your individual vehicle.

Control Center, for principle details, refer to page 16:

1. Open the **i** menu
2. Select "Communication interface" and press the controller
3. Select "BMW Service settings" and press the controller
4. Move the controller forwards to change the field

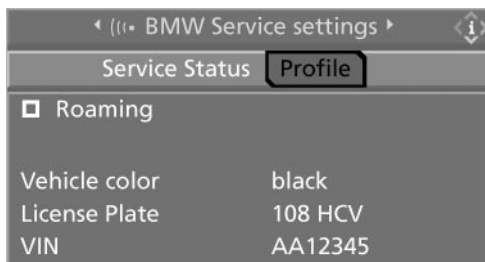

5. Select "Profile" and press the controller.



# امداد خودرو فارما

تلفن شبانه روزی: ۰۲۱-۸۸۸۶۲۰۸۵

[FarmaSOS.com](http://FarmaSOS.com)



# امداد خودرو فارما

## Mobility

This section helps you maintain your mobility by supplying important information on vital topics including fuels and lubricants, wheels and tires, service, maintenance and how to deal with any problems that may occur.

تلفن شبانه روزی: ۰۲۱-۸۸۸۶۲۰۸۵

[FarmaSOS.com](http://FarmaSOS.com)

# Refueling

## Fuel filler door



**⚠** Always switch off the engine before refueling. If you do not, fuel cannot be filled into the tank and a message on the Control Display will appear. ◀

To open and close: press the rear edge of the fuel filler door.

## Manual release

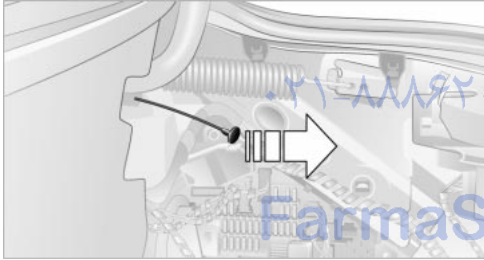

In the event of an electrical defect in the system, you can release the fuel filler door manually:

1. In the luggage compartment, raise the floor mat and the cover located beneath it
2. Open the snap fasteners of the right side panel and take off the side panel
3. Pull the knob with the gas pump symbol.

**⚠** Always observe all applicable precautions and regulations when handling fuels. Never carry spare fuel containers in your vehicle. Whether empty or full, these

containers can leak, cause an explosion, or lead to fire in the event of a collision. ◀

## Simple and environmentally friendly

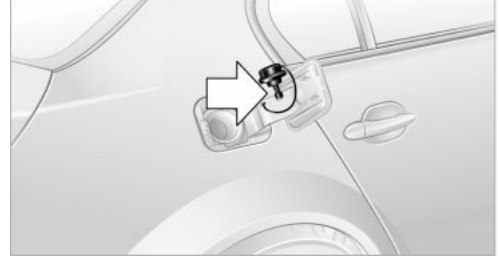

**⚠** When handling fuels always observe any safety guidelines posted at the service station. ◀

Put the filler cap in the bracket attached to the fuel filler door.

When refueling, insert the filler nozzle completely into the filler pipe. Lifting the filler nozzle during refueling

- ▷ results in premature pump shutoff
- ▷ can lead to reduced efficiency in the fuel-vapor recovery system.

The fuel tank is full when the filler nozzle clicks off the first time.

Closing the fuel filler cap:

Fit the cap and turn it clockwise until you clearly hear a click.

**⚠** Close the fuel filler cap carefully after refueling, until a click is heard. While closing, be sure not to squeeze the strap which is fastened to the cap. A loose or missing cap will activate the message Check Gas Cap on the Control Display. ◀

Fuel tank capacity: approx. 18.5 gallons/ 70 liters, of which approx. 2.1 gallons/ 8 liters reserve.

**⚠** Never attempt to continue driving until the tank is completely empty, as engine functions could be affected, and the vehicle could sustain damage as a result. ◀

## Fuel specifications

The engine uses lead-free gasoline only.

Required fuel:

Premium Unleaded Gasoline,  
min. 91 AKI.

AKI = Anti Knock Index.



Do not use leaded fuels. The use of leaded fuels will cause permanent damage to the system's oxygen sensor and the catalytic converter. ◀

امداد خودرو فارما

تلفن شبانه روزی: ۰۲۱-۸۸۸۶۲۰۸۵

FarmaSOS.com

# Wheels and tires

## Tire inflation pressure

### Information for your safety

It is not merely the tire's service life, but also driving comfort and – to a great extent – driving safety that depend on the condition of the tires and the maintenance of the specified tire pressure.

 Check and if necessary adjust tire inflation pressures regularly, also on the compact wheel, at least every two weeks and before beginning a longer trip. If you fail to observe this precaution you may be driving on tires with incorrect tire pressures, a condition that cannot only compromise your vehicle's driving stability, but also lead to tire damage and the risk of an accident.

Do not drive with deflated, i.e. flat tires, except run-flat tires. A flat tire will seriously impair your vehicle's handling and braking response. Attempts to drive on a flat tire can lead to loss of control over the vehicle. ◀

### Checking the pressure

Only check tire inflation pressure when the tires are cold. This means after a maximum of 1.25 miles/2 km driving or when the vehicle has been parked for at least 2 hours. When tires are warm, the tire inflation pressure increases.

After correcting the inflation pressure(s), always reinitialize the Flat Tire Monitor, refer to page 81.

## Inflation pressure for original tires

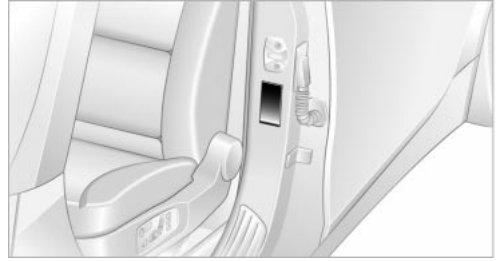



The inflation pressures for your standard tires are visible on the door post when you open the driver's door.

## Inflation pressure for other tire sizes

The tables on the next pages provide all the correct inflation pressures for the specified tire sizes at ambient temperature.

 For correct identification of the right tire inflation pressure for your tires, observe the specifications for the corresponding tire size. ◀

## 525i/530i

Tire size	Pressure specifications in psi/kPa			
	max. 			
All pressure specifications in the table are indicated in psi/kilopascal with cold tires. Cold = ambient temperature				
225/50 R 17 94 V M+S	29/200	35/240	36/250	44/300
225/50 R 17 94 W				
245/40 R 18 93 W				
225/55 R 16 95 Q,T,H M+S				
225/50 R 17 94 Q,T,H M+S				
Only 525i:				
225/55 R 16 95 V M+S				
225/55 R 16 95 V				
245/45 R 17 95 W	29/200	32/220	33/230	41/280
245/45 R 17 95 V M+S				
Front: 245/40 R 18 93 W	29/200	-	36/250	-
Rear: 275/35 R 18 95 W	-	32/220	-	41/280
Front: 245/35 R 19 89 Y	29/200	-	33/230	-
Rear: 275/30 R 19 92 Y	-	32/220	-	41/280
Compact wheel: T 135/80 R 17 102 M			61/420	

More details on the permitted load and weights can be found on page [200](#).

تلفن شبانه روزی: ۰۸۵-۸۸۸۶۲۰۲۱

FarmaSOS.com

## 545i

### Tire size

### Pressure specifications in psi/kPa

All pressure specifications in the table are indicated in psi/ kilopascal with cold tires. Cold = ambient temperature



225/50 R 17 94 V M+S	32/220	38/260	38/260	45/310
225/50 R 17 94 W				
245/40 R 18 93 Y				
225/50 R 17 94 Q,T,H M+S				
245/45 R 17 95 W	29/200	35/240	35/240	42/290
245/45 R 17 95 V M+S				
Front: 245/40 R 18 93 Y	32/220	-	38/260	-
Rear: 275/35 R 18 95 Y	-	35/240	-	42/290
Front: 245/35 R 19 89 Y	32/220	-	38/260	-
Rear: 275/30 R 19 92 Y	-	35/240	-	42/290
Compact wheel: T 135/80 R 17 102 M			61/420	

More details on the permitted load and weights can be found on page [200](#).

## Tire identification marks

Knowledge of the labeling on the side of the tire makes it easier to identify and choose the right tires.

W = up to 167 mph/270 km/h

Y = up to 186 mph/300 km/h

### Tire size

e.g. 205/60 R 15 91 W

Nominal width in mm

Aspect ratio in %

Radial type

Rim diameter in inches

Load rating (not on ZR tires)

Speed rating (before R on ZR tires)

### Tire Identification Number

Tires with DOT codes meet the guidelines of the U.S. Department of Transport.

DOT code:

e.g. DOT xxxx xxx 3602

Manufacturer code

for tire make

Tire size and tire design

Tire age

### Speed letter

Q = up to 100 mph/160 km/h

T = up to 118 mph/190 km/h

H = up to 131 mph/210 km/h

V = up to 150 mph/240 km/h

### Tire age

The date of manufacture of the tires is marked on the tires themselves:

DOT ... 3603 means that the tire was made in the 36th week of 2003.

BMW recommends that you replace all tires after 6 years at the latest, independen-

dently of the fact that tires can reach an age of 10 years.

## Uniform Tire Quality Grading

Quality grades can be found where applicable on the tire sidewall between tread shoulder and maximum section width. For example:

Treadwear 200 Traction AA  
Temperature A

## DOT Quality Grades

Treadwear  
Traction AA A B C  
Temperature A B C

 All passenger car tires must conform to Federal Safety Requirements in addition to these grades. ◀

## Treadwear

The treadwear grade is a comparative rating based on the wear rate of the tire when tested under controlled conditions on a specified government test course.

For example, a tire graded 150 would wear one and one-half (1 ½) times as well on the government course as a tire graded 100. The relative performance of tires depends upon the actual conditions of their use, however, and may depart significantly from the norm due to variations in driving habits, service practices and differences in road characteristics and climate.

## Traction

The traction grades, from highest to lowest, are AA, A, B, and C.

Those grades represent the tire's ability to stop on wet pavement as measured under controlled conditions on specified government test surfaces of asphalt and concrete. A tire marked C may have poor traction performance.

 The traction grade assigned to this tire is based on straight-ahead braking traction tests, and does not include acceleration, cornering, hydroplaning, or peak traction characteristics. ◀

## Temperature

The temperature grades are A – the highest – B, and C, representing the tire's resistance to the generation of heat and its ability to dissipate heat when tested under controlled conditions on a specified indoor laboratory test wheel.

Sustained high temperature can cause the material of the tire to degenerate and reduce tire life, and excessive temperature can lead to sudden tire failure. The grade C corresponds to a level of performance which all passenger car tires must meet under the Federal Motor Vehicle Safety Standard No. 109. Grades B and A represent higher levels of performance on the laboratory test wheel than the minimum required by law.

 The temperature grade for this tire is established for a tire that is properly inflated and not overloaded. Excessive speed, underinflation, or excessive loading, either separately or in combination, can cause heat buildup and possible tire failure. ◀

## RSC – Run-flat tires

You will recognize run-flat tires by a circular symbol containing the letters RSC on the side of the tire, refer to page 175.

## M+S

Winter and all-season tires.

These have better winter properties than summer tires.

## Tire condition

Inspect your tires frequently for treadwear, signs of damage and for foreign objects lodged in the tread. Check the tread depth.

## Tire tread

The tread depth should not drop below 0.12 in/3 mm, although, for example, European legislation only specifies a minimum tread depth of 0.063 in/1.6 mm. At tread depths below 0.12 in/3 mm there is an increased risk of high-speed hydroplaning,

even when only small amounts of water are present on the road surface.

As winter tires display a noticeable loss in their ability to cope with cold-weather driving conditions once the tread wears to below 0.16 in/4 mm, to ensure continued safety you should always have such tires replaced.

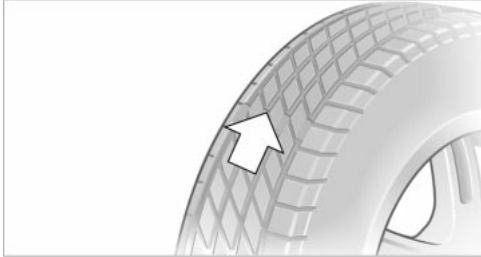

Wear indicators at the tread-groove base, refer to arrow, are distributed over the tire's circumference and are marked on the side of the tire with TWI – Tread Wear Indicator. These indicators signal at a tread depth of 0.063 in/1.6 mm that the legal wear limit has been reached.

### Tire damage

**!** Unusual vibrations encountered during normal vehicle operation can indicate tire failure or some other vehicle defect. This can, for example, be caused by driving over curbs. These kinds of problems may also be signaled by other changes in vehicle response, such as a strong tendency to pull to the left or right. Should this occur, respond by immediately reducing your speed. Carefully proceed – or have your vehicle towed – to the nearest BMW center or tire dealer to have the wheels or tires inspected. Tire damage, extending to sudden and complete loss of pressure in extreme cases, can pose a potentially lethal safety hazard for the vehicle's occupants and other road users alike. ◀

## Replacing wheels/tires

**!** Unprofessional attempts by laymen to service tires can lead to damage and accidents. Have this work performed by skilled professionals only. The technicians at your BMW center will be glad to assist you with the required professional knowledge and specialized equipment. ◀

The correct combination of wheels and tires is another vital factor in ensuring reliable operation of various vehicle systems such as ABS and DSC.

Have the wheel and tire assemblies balanced every time either a wheel or a tire is replaced.

**!** BMW does not recommend the use of retreaded tires, as otherwise driving safety may be reduced. Possible variations in the design and the age – which could be substantial – of the carcasses can lead to unusually rapid wear. ◀

### The right wheels and tires

**!** BMW recommends that you use only wheel and tire combinations that BMW has tested and approved for your particular vehicle. Variations in factors such as manufacturing tolerances mean that even wheels and tires with identical official size ratings could actually have different dimensions than the approved units – these differences could lead to body contact, and with it the risk of severe accidents. If non-approved wheels and tires are used, BMW cannot evaluate their suitability, and therefore cannot be held liable for driving safety. ◀

To maintain good handling and vehicle response, use only tires of a single tread configuration from a single manufacturer. After a flat tire, always remember to have the specified wheel and tire combination remounted on the vehicle as soon as possible.

### Recommended tire brands

BMW tests certain tire brands for each tire size, classifies them as road-safe and



approves them. You can find out about these at specialized dealers or at your BMW center. Observe any country-specific regulations, e.g. on making a corresponding entry in the vehicle documents.

The factory-mounted tires have been specially selected to provide optimized performance when installed on your vehicle; if properly cared for, they will provide a combination of safety and excellent ride comfort.

### Run-flat tires

If your BMW is equipped with run-flat tires, refer to Run-flat tires, only use these tires, as in the event of a breakdown there is no spare wheel available.

### Special characteristics of winter tires

BMW recommends winter tires for use in cold winter driving conditions. Although all-season M+S tires provide better winter traction than summer tires, they generally fail to provide the same levels of cold-weather performance as winter tires.

When switching to winter tires, observe the descriptions at Tire condition and Replacing wheels/tires, refer to pages 173 and 174.

### Run-flat tires

If your BMW is equipped with run-flat tires, refer to Run-flat tires. Your BMW center will advise you if you wish to replace the tires of your BMW or wish to switch from summer to winter tires or vice versa.

If you switch from summer to winter tires, or vice versa, use run-flat tires, as in the event of a flat there is no spare wheel available.

### Observing speed ratings

 Never exceed the maximum speed for which the winter tires are rated. Unprofessional attempts by laymen to service tires can lead to damage and accidents. Have this work performed by skilled professionals only. The technicians at your

BMW center will be glad to assist you with the required professional knowledge and specialized equipment. ◀

### Storage

Always store wheels and tires in a cool, dry place with as little exposure to light as possible. Always protect tires against all contact with oil, grease and fuels. Do not exceed the maximum tire inflation pressure indicated on the side wall of the tire.

### Run-flat tires\*

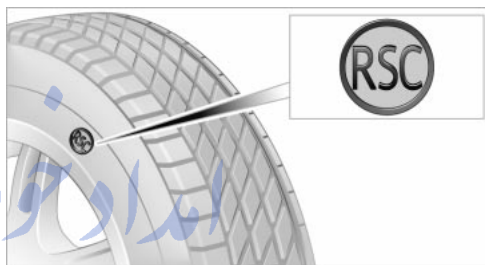

You will recognize run-flat tires by a circular symbol containing the letters RSC on the side of the tire. Run-flat tires consist of self-contained tires and special rims. The tire reinforcement ensures that the tire retains some residual safety in the event of pressure drop and driving remains possible to a restricted degree.

 If you switch from summer to winter tires, or vice versa, use run-flat tires, as in the event of a breakdown there is no spare wheel available. In this case, BMW recommends that you consult your BMW center. Your BMW center is qualified to handle run-flat tires and equipped with the necessary special tools. ◀

### Continuing driving with a damaged tire

Driving on run-flat tires can continue, depending on the vehicle load and the severity of the tire damage, at a maximum speed of 50 mph/80 km/h.

In the case of complete tire pressure loss, 0 psi/0 kPa, or obvious tire damage, you

can estimate the possible distance for continued driving on the basis of the following guide values:

- ▷ With low load:
  - 1 to 2 persons without luggage:
  - Approx. 155 miles/250 km
- ▷ With medium load:
  - 2 persons, luggage compartment full, or
  - 4 persons without luggage:
  - Approx. 90 miles/150 km
- ▷ With full load:
  - 4 persons or more, luggage compartment full:
  - Approx. 30 miles/50 km.



Drive reservedly and do not exceed a speed of 50 mph/80 km/h. With inflation pressure loss, the driving characteristics change, for example reduced track stability on braking, extended braking distance, and altered self-steering characteristics.

For safety reasons, BMW recommends that you do not have damaged run-flat tires repaired and that you consult your BMW center in this case. ◀

## Snow chains\*

تلفن شبانه روزی: ۰۲۱-۸۸۶۲۰۸۵

BMW only tests certain snow chains, classifies them as road-safe and approves them. Consult your BMW center for more information. BMW recommends only using these approved, narrow-link snow chains. These snow chains are approved exclusively for use on summer or winter tires in pairs on the rear wheels.

Observe the manufacturer's instructions when installing snow chains.

Do not exceed a vehicle speed of 30 mph/50 km/h with the chains mounted.



After mounting snow chains, do not activate the Flat Tire Monitor.

When you are driving with snow chains, it can be beneficial to switch off DSC briefly, refer to page 78. ◀

# Under the hood

## Hood

### Unlocking

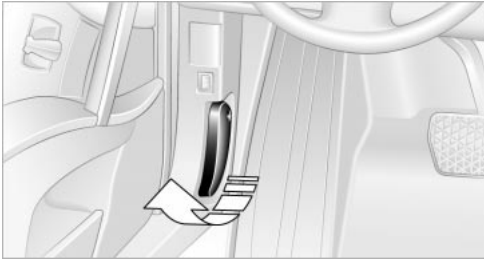

MN02021CMA

Pull the lever located under the left side of the instrument panel.

**⚠** Never attempt to perform any service or repair operations on your vehicle without the required, professional technical training. When you are unfamiliar with the service procedures and precautions, always have any required work carried out at your BMW center. Unprofessional attempts at service and repair, and the incorrect handling of parts and materials that can occur during such attempts, constitute a potential safety hazard, both for the vehicle's occupants and for other road users. ◀

### Opening

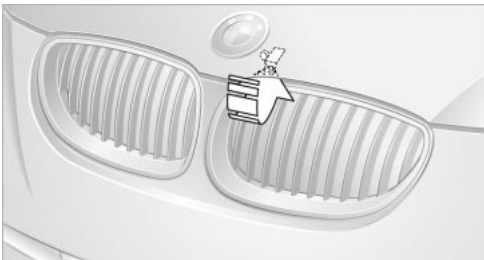

MN02022CMA

Press the release handle and open the engine hood.

### Closing

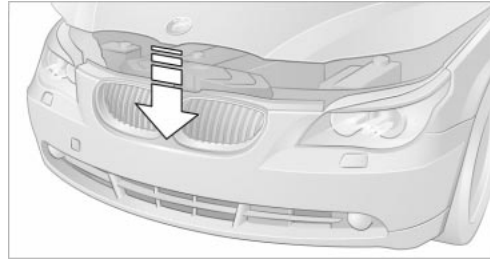

MN02760CMA

Close the hood from a height of approx. 16 in/40 cm with momentum. It must be clearly heard to engage.

**⚠** Observe the same precautions that apply to all closing operations by ensuring that the hood's travel range is clear and unobstructed before allowing the hood to fall into position. If you see any signs that the hood is not completely closed while driving your vehicle, you should stop at once and close it securely. ◀

FarmaSOS.com

## Engine compartment

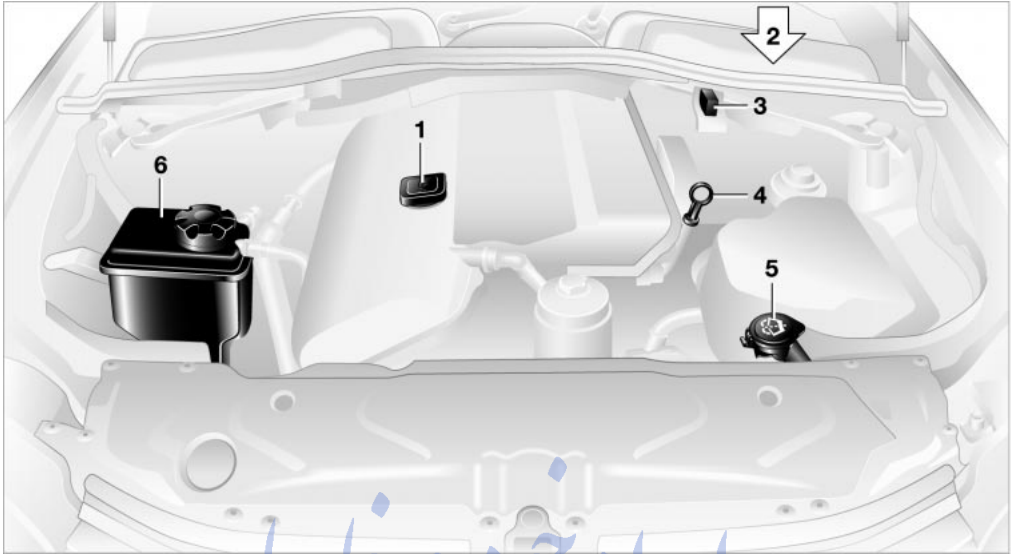

- 1 Filler neck for engine oil, refer to Topping up engine oil
  - 2 Brake fluid reservoir, located beneath the microfilter cover, refer to page 180
  - 3 Starting-aid terminal, refer to page 192
  - 4 Dipstick for engine oil, refer to Checking the oil level. The dipstick is further toward the rear on the 545i
  - 5 Washer fluid reservoir of the headlamp and windshield cleaning systems, refer to page 57
  - 6 Expansion tank for coolant, refer to page 179
4. Carefully push the dipstick all the way into the guide tube and pull it out again
5. The oil should extend to between the two marks on the dipstick.
- As is the case with fuel economy, the rate at which the engine uses oil is strongly influenced by driving style and operating conditions.

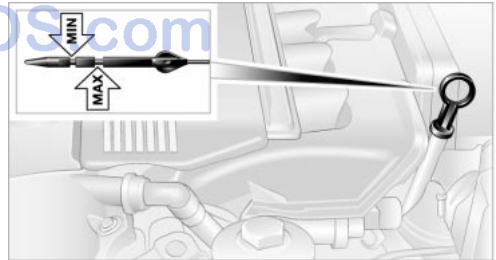

## Engine oil

### Checking oil level

1. Park the vehicle on a level surface
2. Switch the engine off after it has reached normal operating temperature
3. After approx. 5 minutes, pull the dipstick 4 out and wipe it off with a clean lint-free cloth, paper towel, or similar material

The oil quantity between the two marks on the dipstick is approx. 1.6 US quarts/ 1.5 liters. Do not fill beyond the upper mark on the dipstick. Excess oil can damage the engine.

## Adding engine oil

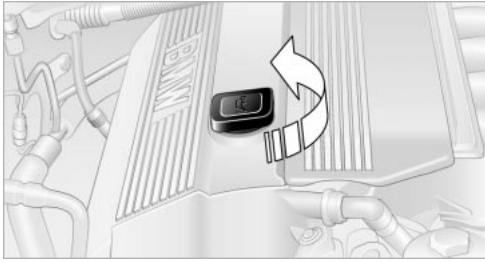

Wait until the level has dropped to just above the lower mark or a message appears on the Control Display before adding oil.

 BMW engines are designed to operate without additives, and their use could even lead to damage in some cases. This also applies to the automatic transmission, the differential and the power steering system. ◀

Recommendation: have oil changes performed only by your BMW center.

 Continuous exposure to used oil has caused cancer in laboratory testing. For this reason, any skin areas that come into contact with oil should be thoroughly washed with soap and water. Store oil, grease, etc., well out of the reach of children; always observe all warning labels on the containers. ◀

 Always observe all applicable rules and regulations for environmental protection when disposing of used oil. ◀

## Specified engine oils

The quality of the engine oil selected has critical significance for the operation and service life of an engine. BMW approves only specific oils after confirming their suitability for use in its vehicles with extensive testing.

Use only approved BMW High Performance Synthetic Oil.

If you are unable to obtain BMW High Performance Synthetic Oil, you can add small amounts of another synthetic oil between oil changes. Use only oils with the API SH specification or higher.

 Ask your BMW center for details concerning the specific BMW High Performance Synthetic Oil or synthetic oils which have been approved. ◀

You can also call BMW of North America at 1-800-831-1117 or visit this website: [www.bmwusa.com](http://www.bmwusa.com) to obtain this information.

## Viscosity ratings

Viscosity is the oil flow rating as defined in SAE classes.

The selection of the correct SAE class depends on the climatic conditions in the area where you typically drive your BMW.

 Approved oils are in SAE classes 5W-40 and 5W-30. ◀

These oils may be used for driving in all ambient temperatures.

## Coolant

 Do not add coolant to the cooling system when the engine is hot. Escaping coolant can cause burns.

Antifreeze and anticorrosion agents are hazardous to health. Always store these agents in tightly-closed original containers kept well away from the reach of children. Antifreeze and anticorrosion agents are flammable. Therefore, do not pour over hot engine parts, as otherwise they could catch fire and cause burns.

Always observe the instructions for use provided on the containers. ◀

 Always observe all applicable rules and regulations for environmental protection when disposing of used antifreeze and anticorrosion agents. ◀

## Checking coolant level

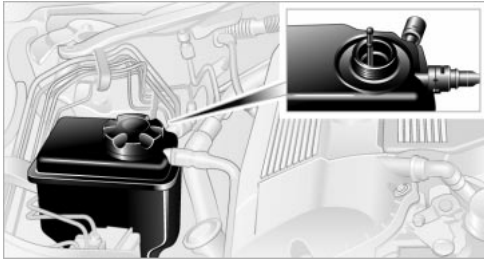

Correct coolant level with the engine cold, approx. +68 °F / 20 °C:

1. Turn the cap of the expansion tank counterclockwise to allow any accumulated pressure to escape, then continue turning to open
2. The coolant level is correct when the coolant extends to between the MIN and MAX marks on the filler neck, refer to the diagram adjacent to the filler neck
3. If the coolant is low, slowly add coolant up to the specified level – do not overfill.

## Brake fluid



The symbol lights up and a message appears on the Control Display: the brake-fluid level in the container is too low.

The brake fluid reservoir is located under the microfilter housing trim panel on the driver's side of the vehicle. To have brake fluid added to the system, or to have the source of any brake fluid loss traced and rectified, please contact your BMW center, which can also supply the factory-approved – DOT 4 – brake fluids.



Brake fluid is hygroscopic: it absorbs moisture from the atmosphere over the course of time.

To ensure that the brake system continues to provide safe and reliable performance, remember to have the brake fluid changed every 2 years at the latest, refer to page 66 and to the Service and Warranty Information Booklet for US models or the Warranty

and Service Guide Booklet for Canadian models.

Brake fluid is toxic and also damages vehicle paintwork. Always store these agents in tightly-closed original containers kept well away from the reach of children.

Do not spill the fluid and do not refill the brake fluid reservoir to beyond the MAX mark. Should it come into contact with hot engine components, the brake fluid could ignite and cause personal injury in the form of burns. ◀



Always observe all applicable rules and regulations for environmental protection when disposing of used brake fluid. ◀



Warning lamp for Canadian models.

## Brake hydraulic systems

A low brake-fluid level combined with longer-than-usual pedal travel could be a sign that one of the brake system's hydraulic circuits has failed.



Proceed to the nearest BMW center. Remember that pedal travel may be increased, and there may also be a substantial increase in the amount of pedal pressure required to brake the vehicle. Please adapt your driving style accordingly. ◀

# Maintenance

## The BMW Maintenance System

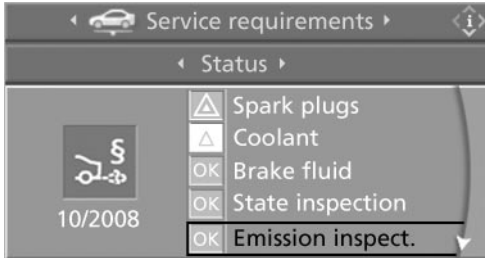

The BMW Maintenance System is designed to ensure that your vehicle will continue to furnish consistent reliability combined with optimal safety. The service schedule also includes operations related to the vehicle's comfort and convenience features, such as replacement of the filters for the inside air. The ultimate objective is to ensure economical maintenance by providing the ideal service for your vehicle.

Should the day come when you decide to sell your BMW, you will find that a complete dealer service history is an asset of inestimable value.

### CBS Condition Based Service

CBS is a more advanced version of the Service Interval Display. Sensors combine with highly-specialized algorithms to supply service information that reflects your vehicle's actual operating conditions more precisely than ever before.

The system now provides individual displays of the times or distances remaining until the deadlines for specific service operations as well as legally prescribed inspections:

- ▷ Engine oil
- ▷ Brakes: separate for front and rear
- ▷ Brake fluid
- ▷ Spark plugs

- ▷ Vehicle check
- ▷ Depending on national regulations: legally prescribed inspections.

CBS monitors both current and upcoming service requirements. Your vehicle stores this information continuously in the ignition key while the vehicle is being driven. You should therefore hand over to the BMW Service Advisor the key you last used to drive when you take your vehicle for service. After accessing the data stored in the vehicle key, your BMW Service Advisor is able to suggest precisely the right array of service procedures for your own individual vehicle.

By letting you define a service and maintenance regimen that reflects your own individual requirements, Condition Based Service builds the basis for trouble-free driving.

You can find more detailed information on the service requirement display on page 66.

 Make sure the date in the Control Center is always set correctly, refer to page 75, as otherwise the effectiveness of Condition Based Service CBS is not ensured. ◀

### Service and Warranty Information Booklet for US models and Warranty and Service Guide Booklet for Canadian models

Please consult your Service and Warranty Information Booklet for US models and Warranty and Service Guide Booklet for Canadian models for additional information on service requirements.

 Have service and repair operations performed at your BMW center. Take the time to ensure that these service procedures are confirmed by entries in your vehicle's Service and Warranty Information Booklet for US models and Warranty and Service Guide Booklet for Cana-

dian models. These entries verify that your vehicle has received the specified regular maintenance, and may also be required when submitting warranty claims. ◀

## Care

You can find everything you need to know on this topic by consulting the separate Caring for your vehicle brochure.

امداد خودرو فارما

تلفن شبانه روزی: ۰۸۵-۸۸۸۶۲-۰۲۱

FarmaSOS.com



# Rules and regulations

## California Proposition 65 Warning

California laws require us to issue the following warning:

 Engine exhaust and a wide variety of automobile components and parts, including components found in the interior furnishings in a vehicle, contain or emit chemicals known to the State of California to cause cancer and birth defects and reproductive harm. In addition, certain fluids contained in vehicles and certain products of component wear contain or emit chemicals known to the State of California to cause cancer and birth defects or other reproductive harm.

Battery posts, terminals and related accessories contain lead and lead compounds. Wash your hands after handling.

Used engine oil contains chemicals that have caused cancer in laboratory animals. Always protect your skin by washing thoroughly with soap and water. ◀

## OBD connector

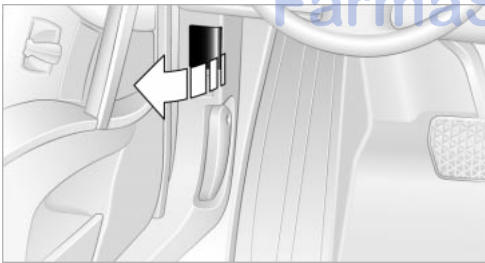

The Onboard Diagnostic OBD interface socket is located on the left of the driver's side under the instrument panel and under a cover.

The cover has the letters OBD on it.

The purpose of the OBD system is to ensure proper operation of the emission control system for the vehicle's lifetime.

The system monitors emissions-related components and systems for deterioration and malfunction.



An illuminated indicator lamp informs you of the need for service, not of the need to stop the vehicle.

However, the systems should be checked by your BMW center at the earliest possible opportunity.



Indicator lamp for Canadian models.

Under certain conditions, the indicator will blink or flash. This indicates a rather severe level of engine misfire. When this occurs, you should reduce speed and consult the nearest BMW center as soon as possible. Severe engine misfire over only a short period of time can seriously damage emissions control components, especially the catalytic converter.



When the fuel filler cap is not properly tightened, the OBD system can detect the vapor leak and the indicator lamp will light up. If the filler cap is subsequently tightened, the indicator lamp should go out within a few days. ◀

# Replacing components

## Onboard tool kit

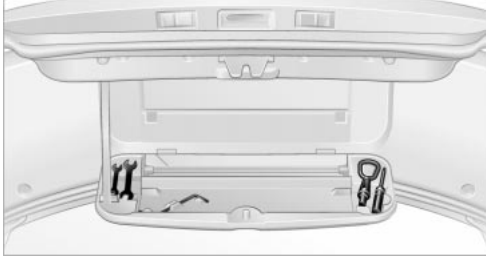

The onboard tool kit is located in the luggage compartment lid.

Loosen the wingnut to open.

## Windshield wiper blades



To replace, fold the wiper arm up and hold. Press the catches together while pushing the wiper blade out of the front.

## Lamps and bulbs

The lamps and bulbs are essential factors contributing to the safety of your vehicle. Therefore, comply fully with the following instructions during bulb replacement. If you are not familiar with the specified procedures, have the replacements carried out at your BMW center.

▶ Never touch the glass of new bulbs with your bare fingers, as even minute amounts of contamination will burn into the

bulb's surface and reduce its service life. Use a clean cloth, napkin, etc., or hold the bulb by its metal socket.

In the case of bulbs where the replacement is not described, please consult your BMW center. ◀

You can obtain a selection of replacement bulbs at your BMW center.

⚠ To prevent short circuits, before working on any electrical system, equipment or accessory you should always switch it off and disconnect the cable from the battery's negative terminal before starting.

To avoid possible injury or equipment damage when changing bulbs, observe any instructions provided by the bulb manufacturer. ◀

▶ When maintaining the headlamps, please comply with the instructions in the separate Caring for your vehicle brochure. ◀

## Headlamps

The illustration shows the left-hand side of the engine compartment.

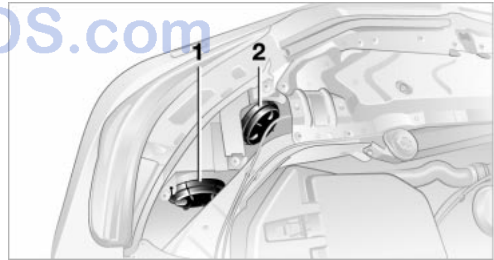

1 Cover cap for low beams

2 Cover cap for high beams

Turn the cover cap to the left and remove.

⚠ Always wear gloves and eye protection – the atmosphere within the H7 bulb is pressurized. Failure to observe this precaution can lead to personal injury should the bulb be damaged. ◀



For checking and adjusting headlamp aim, please contact your BMW center. ◀

### Halogen low beams

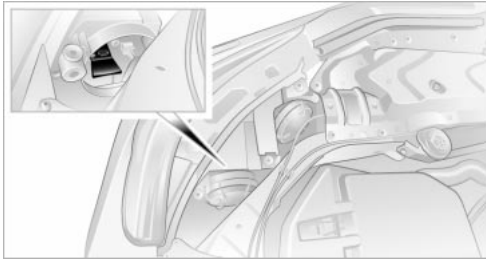

H7 bulb, 55 Watts

1. Turn the bulb holder to the left and remove
2. Remove and replace the bulb.

### Halogen high beams

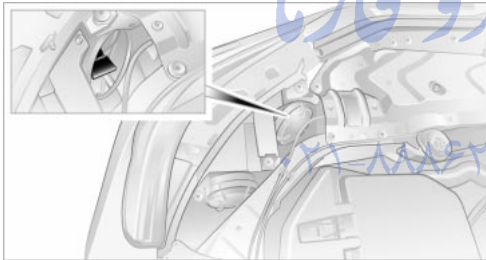

H7 bulb, 55 Watts

1. Turn the bulb holder to the left and remove
2. Remove and replace the bulb.

### Parking and standing lamps

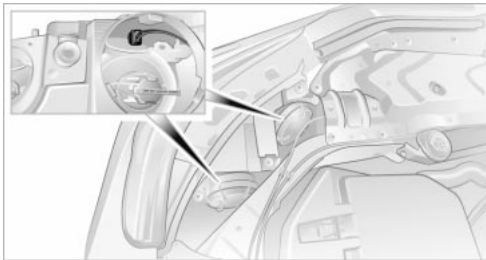

Bulb 5 Watts, W 5 W

1. Turn the cover cap for low beams or high beams to the left and remove
2. Pull the bulb holder out
3. Remove and replace the bulb.

### Xenon lamps\*

The service life of these bulbs is very long and the probability of a failure is very low, provided that they are not switched on and off an unusual number of times.

In the unlikely event that one of these lamps should fail, you can respond by switching on your fog lamps and proceeding carefully, where allowed by law.



To avoid the risk of potentially fatal injuries: owing to the extremely high voltages at which these units operate, service work on the xenon lighting system should always be entrusted to qualified personnel. ◀

### Parking and standing lamps

Please contact a BMW center in case of a malfunction.

### Turn signal indicators, front

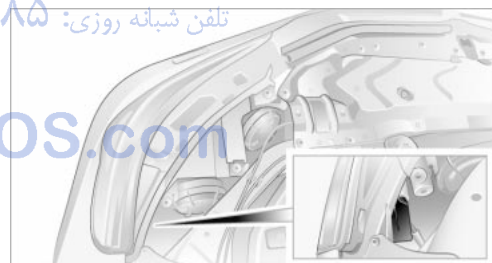

Bulb 21 Watts, PY 21 W

1. Turn the bulb holder to the left and remove
2. Apply gentle pressure to the bulb while turning it to the left for removal and replacement.

### Side-mounted turn signal indicators

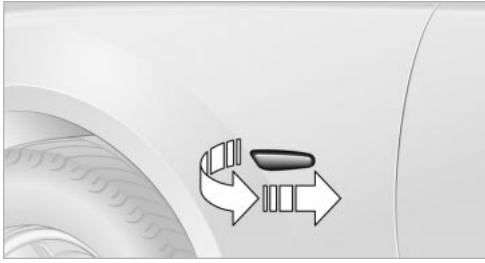

Bulb 5 Watts, W 5 W

1. Press against the front edge of the lamp with the tip of your finger, then push it to the rear and release the detent at the front
2. Turn the lamp 90° and remove
3. Turn the bulb holder to the left and remove
4. Extract the bulb for replacement.

### Side marker lamps, front and rear

Please contact your BMW center for replacement.

### Tail lamps

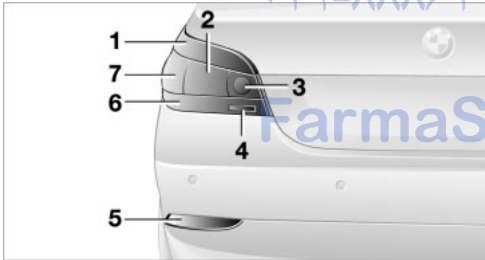

- 1 Turn signal indicators
- 2 Tail and brake lamp
- 3 Tail lamp
- 4 Backup lamps
- 5 Reflector
- 6 Reflector
- 7 Standing, tail and brake lamp
  - ▷ Backup lamps:  
Bulb 16 Watts, W 16 W
  - ▷ Other lamps:  
Bulb 21 Watts, P 21 W

### Center brake lamp

This lamp uses LED technology for operation. Please contact a BMW center in case of a malfunction.

### Lamps in the fender

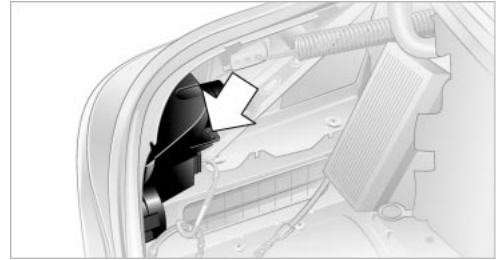

The illustration shows the recess on the left side of the luggage compartment.

All the bulbs are integrated in a central bulb holder.

1. Remove the side panel
2. Unclip the bulb holder and remove
3. Backup lamps:

Remove and replace the bulb.

Other bulbs:

Apply gentle pressure to the bulb while turning it to the left for removal and replacement.

### Lamps in the luggage compartment lid

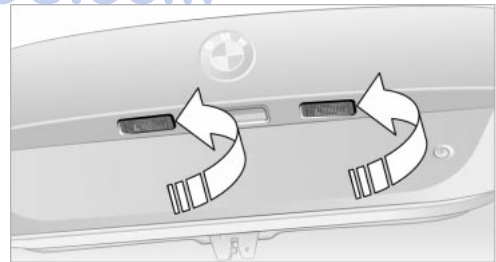

### License plate lamp

Bulb 5 Watts, C 5 W

1. Insert a screwdriver in the slot and press to the left, refer to arrows; this unlocks the lamp
2. Remove the lamp and replace the bulb.

## Changing a wheel

 Safety measures in the event of a breakdown or wheel change:

Park the vehicle as far away as possible from moving traffic and on firm ground. Switch on the hazard warning flashers. Lock the steering wheel in straight-ahead setting of the wheels. Apply the handbrake and engage first gear, reverse gear or selector lever to position P.

Have all vehicle occupants get out of the vehicle and ensure that they remain outside the immediate area in a safe place, such as behind a guardrail.

If a warning triangle or portable hazard warning lamp is required, set it up on the roadside at an appropriate distance from the rear of the vehicle.

Comply with all safety guidelines and regulations.

Change the wheel only on a level, firm surface which is not slippery.

The vehicle or the jack could slip to the side if you attempt to raise the vehicle on a soft or slippery surface such as snow, ice, tiles, etc.

Position the jack on a firm support surface. Do not use a wooden block or similar object as a support base for the jack, as this would prevent it from extending to its full support height and reduce its load-carrying capacity.

To avoid serious or fatal injury: never lie under the vehicle, and never start the engine while it is supported by the jack. ◀

### What you will need

To avoid rattling noises later on, note the positions of the tools before removing them, then return them to their initial positions after completing work.

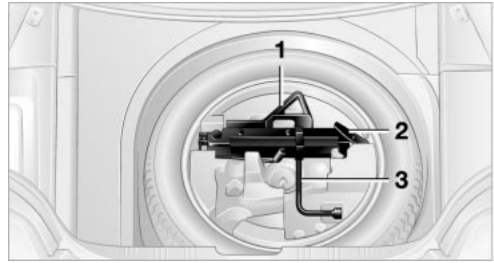

- 1 Chock
- 2 Vehicle jack
- 3 Lug wrench

are located in the tool space in the rim of the compact wheel. Raise the floor mat and the cover beneath it. Take out the required tool(s). After using the tools, return them to the storage space.

### Compact wheel\*

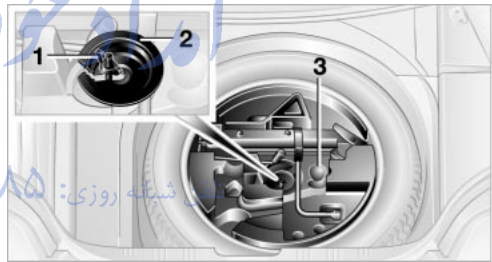

1. Unscrew the wing nut 1
2. Remove the disk 2 to the side
3. Take out the tool brackets 3
4. Remove the compact wheel.

### Procedure

1. Read carefully and comply with the safety precautions on left-hand column
2. To secure the vehicle against movement:
 

Place the wheel chock behind the front wheel on the side opposite the side being raised. If the vehicle is parked on a downward slope, place the chock in front of the wheel. If the wheel must be changed on a surface with a more severe slope, take additional precautions to secure the vehicle from rolling

- Loosen the lug bolts 1/2 a turn



- Set up the jack beneath the jacking point closest to the flat tire. Ensure that the entire surface of the jack's base is in firm contact with the ground and that the jack itself is standing completely vertical, not tilted, and that the fitting on the top of the jack will align with the rectangular recess on the vehicle when you raise it, refer to illustration
- Jack the vehicle up until the wheel you are changing is raised from the ground
- Unscrew the lug bolts and remove the wheel
- Remove accumulations of mud or dirt from the mounting surfaces of the wheel and hub. Clean the lug bolts
- Position the new wheel or compact wheel. Secure the wheel by turning at least two lug bolts into opposite bolt holes
- Screw in the remaining lug bolts. Tighten all the bolts securely in a diagonal pattern
- Lower the jack and remove it from beneath the vehicle
- Tighten the lug bolts in a diagonal pattern
- Check and correct the tire inflation pressure at the earliest opportunity.

 Protect valve stems and valve stem seal caps against dirt and contamination. Dirt in valve stems is a frequent source of gradual air loss. ◀

After mounting the wheel or correcting the inflation pressure, reinitialize the Flat Tire Monitor, refer to page 81.

 The vehicle jack is designed for changing wheels only. Do not attempt to raise another vehicle model with it or to raise any load of any kind. To do so could cause accidents and personal injury. To ensure safety, always have the lug bolts checked with a calibrated torque wrench as soon as possible to ensure that they are tightened to the specified torque. The tightening torque is 120 Nm. ◀

Reverse the removal sequence to store the wheel and tools in the vehicle.

When you mount wheels other than Genuine BMW light-alloy wheels, different lug bolts may also be required.

Always have damaged tires replaced and the wheel and tire assembly rebalanced at the earliest possible opportunity.

## Driving with the compact wheel

Drive reservedly and do not exceed a speed of 50 mph/80 km/h.

The driving characteristics change, for example reduced track stability on braking, extended braking distance, and altered self-steering characteristics in the limit range. In conjunction with winter tires, these characteristics are more pronounced.

 Only one compact wheel may be mounted. You should fit wheels and tires of the original size as quickly as possible. ◀

## Battery

### Battery care

The battery is 100% maintenance-free, i.e., the electrolyte will last for the life of the battery when the vehicle is operated in a temperate climate.

 For all questions that regard the battery, please consult your BMW center. ◀

## Charging the battery

Only charge the battery in the vehicle via the terminals in the engine compartment with the engine off. Connections, refer to Jump-starting on page 192.

## Disposal

 Return used batteries to a recycling point or your BMW center. Maintain the battery in an upright position for transport and storage. Always restrain the battery to prevent it from tipping over during transport. ◀

## Fuses

 Never attempt to repair a blown fuse, and do not replace a defective fuse with a substitute of another color or amperage rating, as this could lead to a circuit overload, ultimately resulting in a fire in the vehicle. ◀

Spare fuses, plastic tweezers and details of the fuse assignment are located in the compartment for the onboard tool kit, refer to page 184.

## In the glove compartment

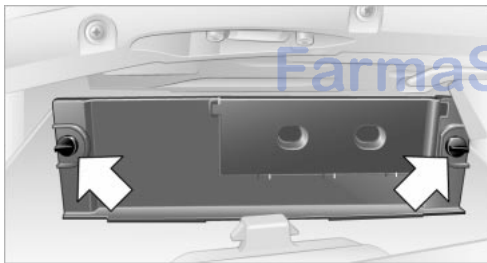

Turn the two snap fasteners outwards. Fold the cover forwards or remove.

## In the luggage compartment

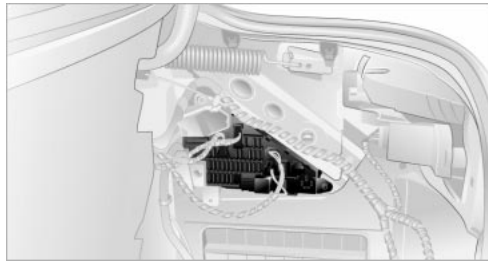

Raise the floor mat and the cover beneath it. Undo the screw connection of the right side panel and pull out the panel.

امداد خودرو فارما

تلفن شبانه روزی: ۰۲۱-۸۸۶۲۰۸۵

FarmaSOS.com

# Giving and receiving assistance

## Starting an emergency call\*

Conditions for an emergency call:

- ▷ The car phone is logged on to a portable phone network
- ▷ The emergency call system is operable.

To start an emergency call:

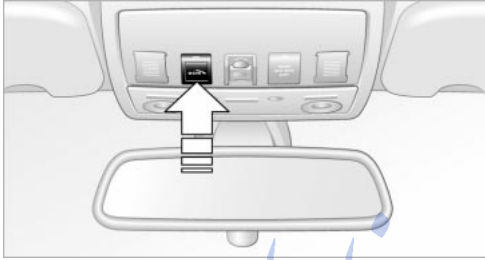

1. To open the cover flap:  
Briefly press the cover flap
2. Press the button for at least 2 seconds.

The indicator lamp in the button lights up. As soon as the voice connection to the general emergency number has been set up, the indicator lamp flashes.

If conditions allow, remain in the vehicle until the connection has been established. You will then be able to provide a detailed description of the situation.

In vehicles where BMW Assist is enabled, the phone system will automatically establish contact with the BMW Assist emergency call center. If the current position of your vehicle can be determined, this is transferred to the BMW Assist emergency call center.

Activating BMW Assist, refer to page 161.



If the navigation system fails, the current position of the vehicle is not transmitted. ◀

If the indicator lamp flashes, but you are unable to hear the emergency call center through the hands-free system, this could indicate, for instance, that the hands-free system is no longer operational. However, the emergency call center can still hear you.



For technical reasons, the emergency call cannot be guaranteed under unfavorable conditions. ◀

Under certain conditions, an emergency call is started automatically immediately after a severe accident. The automatic emergency call is not affected by the button being pressed.



## Warning triangle\*



The warning triangle is conveniently stored in the onboard tool kit mounted on the inside of the luggage compartment lid.

 Comply with legal requirements requiring you to carry a warning triangle in the vehicle. ◀

## First-aid kit\*



You will also find the first-aid kit in the onboard tool kit's container.

 Some of the articles contained in the first-aid kit have a limited service life. For this reason, check the expiration dates of each of the items regularly, and replace any whose expiration dates have passed. You can find replacements in any pharmacy.

Comply with legal requirements requiring you to carry a first-aid kit in the vehicle. ◀

## Roadside Assistance

The Roadside Assistance of the BMW Group offers you assistance in the event of a breakdown around the clock, also at weekends and on public holidays.

The phone numbers of the Roadside Assistance control center in your home country can be found in the BMW Dealer Directory.

In the case of vehicles with BMW Assist or TeleService, you can call the Roadside Assistance of the BMW Group directly via the Control Center, refer to page 162.

امداد خودرو فارما

تلفن شبانه روزی: ۰۲۱ ۸۸۶۲۰۸۵

FarmaSOS.com

## Jump-starting

When your battery is discharged you can use two jumper cables to start your vehicle with power from the battery in a second vehicle. You can also use the same method to help start another vehicle. Use only jumper cables with fully-insulated clamp handles.

 To avoid the risk of potentially fatal injury, always avoid all contact with electrical components while the engine is running. Carefully adhere to the following sequence, both to prevent damage to one or both vehicles, and to guard against possible personal injuries. ◀

### Preparing

1. Check whether the battery of the other vehicle has a voltage of 12 Volts and approximately the same capacitance in Ah. This information can be found on the battery
2. Switch off the engine of the support vehicle
3. Switch off any consumer units in both vehicles.

 There must not be any contact between the bodies of the two vehicles, as otherwise there is a danger of short circuits. ◀

## Connecting the jumper cables

 To avoid personal injury from sparks, always observe this sequence when connecting jumper cables. ◀

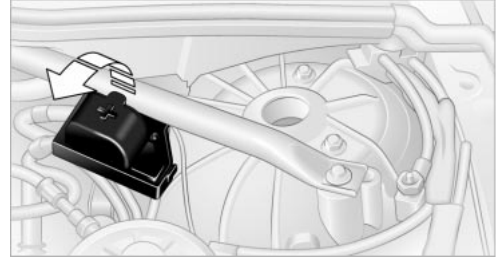

On your BMW, the so-called starting-aid terminal in the engine compartment serves as the battery positive terminal, refer also to Engine compartment overview on page 178. The symbol + is embossed on the cover.

1. Open the cover of the BMW starting-aid terminal. To do so, pull the tab
2. Attach one end of the jumper cable plus/+ to the positive terminal of the battery or a starting-aid terminal of the vehicle providing assistance
3. Attach the second end of the cable to the positive terminal of the battery or to a starting-aid terminal of the vehicle to be started

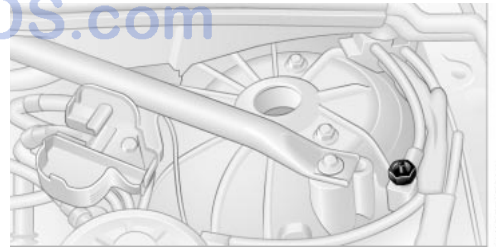

Your BMW has a special nut as body ground or negative pole.

4. Attach one end of the jumper cable minus/- to the negative terminal of the battery or to an engine or body ground of the vehicle providing assistance

- Attach the second end of the cable to the negative terminal of the battery or to the engine or body ground of the vehicle to be started.

## Starting the engine

- Start the engine on the support vehicle and allow it to run for several minutes at a fast idle
- Start the engine on the other vehicle in the usual way.  
If the first start attempt is not successful, wait a few minutes before another attempt in order to allow the discharged battery to recharge
- Let the engines run for a few minutes
- Disconnect the jumper cables by reversing the connection sequence.

If required, have the battery inspected and recharged at your BMW center.

- Never use spray fluids to start the engine. ◀

## Towing

- Always observe all applicable towing laws and regulations. ◀

### Towing with a commercial tow truck

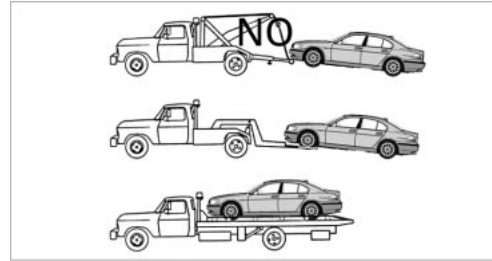

- Use a wheel lift or flatbed carrier
- Do not tow with sling-type equipment.

- Never allow passengers to ride on a towed vehicle for any reason. ◀

### Towing with raised front axle

#### Vehicles with automatic transmission:

- Towing speed:  
Maximum 45 mph/70 km/h
- Towing distance:  
Maximum of 90 miles/150 km.

#### Vehicles with Sequential manual transmission SMG

With the ignition switched on, engage the selector lever position N, then switch off the ignition again.

### Tow fitting

The threaded tow fitting is stored in the tool kit mounted on the inside of the luggage compartment lid, refer to page 184, and should always remain in the vehicle. It can be screwed to the front or rear of the vehicle.

## Access to tow sockets

### Front

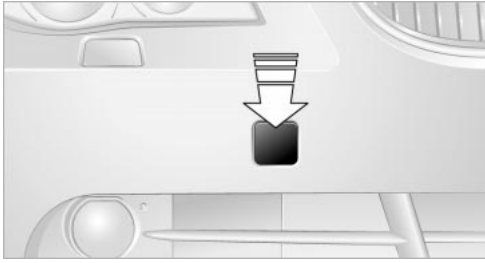

### Rear

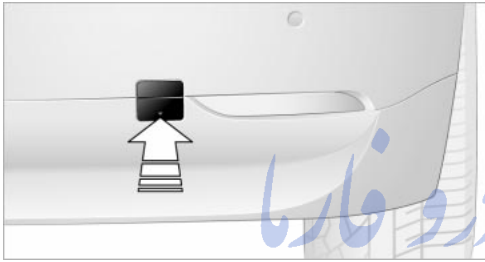

Press the arrow symbol to push out the cover.

 Only use the tow fitting carried in the vehicle and screw it in firmly as far as it will go. Only use the tow fitting for towing on roads. Follow these instructions; otherwise the tow fitting can come loose and lead to damage to the vehicle. [PharmaSOS.com](http://PharmaSOS.com) تلفن شبانه روزی: ۰۸۵ ۰۰۰ ۰۰۰ ۰۰۰

Never attempt to tow or tie down the vehicle using suspension components, as this could lead to damage that might ultimately result in an accident. ◀

# امداد خودرو فارما

تلفن شبانه روزی: ۰۲۱-۸۸۸۶۲۰۸۵

[FarmaSOS.com](http://FarmaSOS.com)



# امداد خودرو فارما

تلفن شبانه روی: ۰۲۱-۸۸۸۶۲۰۸۵

[FarmaSOS.com](http://FarmaSOS.com)

## Reference

This is where to look to find information on any desired topic as quickly as possible. This chapter includes the section with technical information as well as the manual's index.

امداد خود و فارما

تلفن شبانه روزی: ۰۲۶-۸۸۸۶۲۰۸۵

FarmaSOS.com

# Technical data

## Engine specifications

		525i	530i
Displacement	cu in/cm <sup>3</sup>	152.2/2,494	181.8/2,979
Number of cylinders		6	6
Maximum output at engine speed	hp rpm	184 6,000	225 5,900
Maximum torque at engine speed	lb ft/Nm rpm	175/237 3,500	214/290 3,500
Compression ratio	ε	10.5	10.2
Stroke	in/mm	2.95/75.0	3.53/89.6
Bore	in/mm	3.31/84.0	3.31/84.0
Fuel-injection system	Digital electronic engine-management system		

		545i
Displacement	cu in/cm <sup>3</sup>	268.4/4,398
Number of cylinders		8
Maximum output at engine speed	hp rpm	325 5,900
Maximum torque at engine speed	lb ft/Nm rpm	330/448 3,600
Compression ratio	ε	10.0
Stroke	in/mm	3.26/82.7
Bore	in/mm	3.60/92.0
Fuel-injection system	Digital electronic engine-management system	



## Dimensions

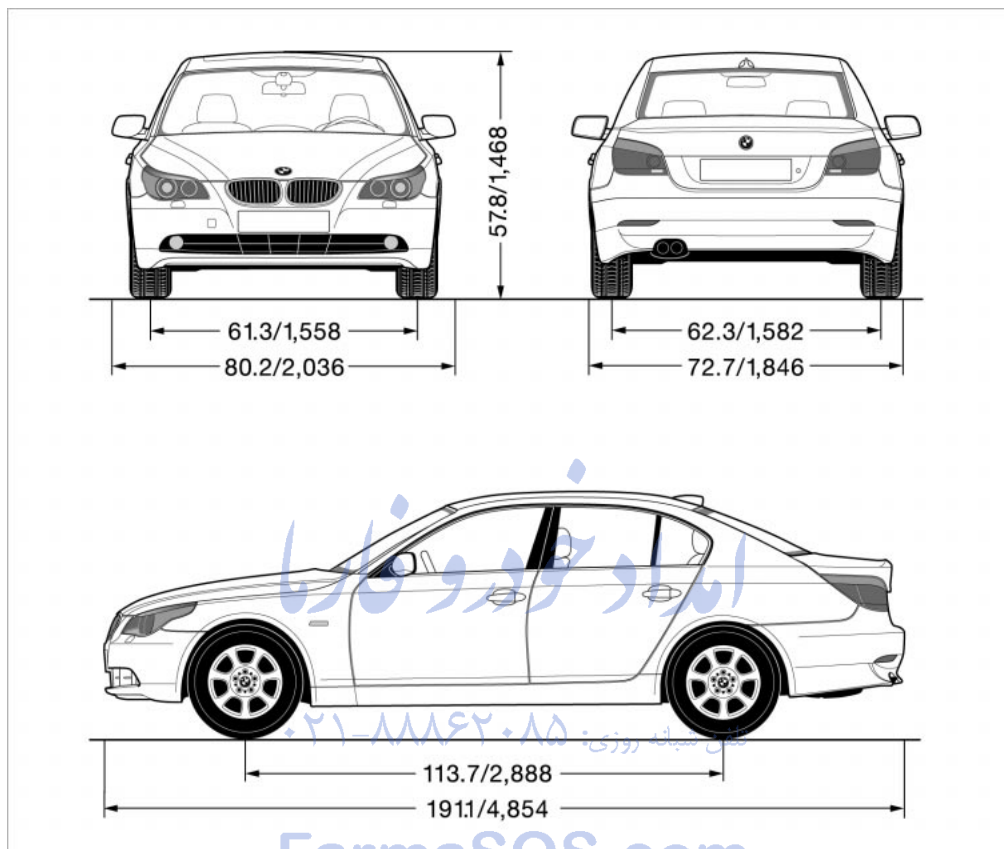

All dimensions in inch/mm. Minimum turning circle dia.: 37.5 ft/11.44 m

## Weights

		525i	530i
Curb weight	lbs./kg		
with manual transmission		3,428/1,555	3,472/1,575
with automatic transmission		3,450/1,565	3,494/1,585
Approved gross weight	lbs./kg		
with manual transmission		4,530/2,055	4,575/2,075
with automatic transmission		4,552/2,065	4,597/2,085
Load	lbs./kg	1,102/500	1,102/500
Approved front axle load	lbs./kg	2,161/980	2,227/1,010
Approved rear axle load	lbs./kg	2,601/1,180	2,601/1,180
Approved roof load capacity	lbs./kg	220/100	220/100
Luggage compartment volume	cu ft/l	18.4/520	18.4/520

			545i
Curb weight	lbs./kg		
with manual transmission			3,803/1,725
with automatic transmission			3,814/1,730
Approved gross weight	lbs./kg		
with manual transmission			4,905/2,225
with automatic transmission			4,916/2,230
Load	lbs./kg		1,103/500
Approved front axle load	lbs./kg		2,403/1,090
Approved rear axle load	lbs./kg		2,679/1,215
Approved roof load capacity	lbs./kg		220/100
Luggage compartment volume	cu ft/l		18.4/520

Never exceed either the approved axle loads or the gross vehicle weight.

## Capacities

			Notes
Fuel tank	gal/liters	approx. 18.5/70	Fuel quality: page 169
Reserve	gal/liters	approx. 2.1/8	
Window and headlamp washer system	quarts/liters	approx. 3.2/3	For details: page 57
Engine with oil filter renewal			BMW High Performance Synthetic Oil.
525i/530i	quarts/liters	6.9/6.5	Oil grades: page 179
545i	quarts/liters	8.5/8.0	
Manual, automatic transmission and differential		-	Lifetime fluid, no fluid change required

امداد خودرو فارما

تلفن شبانه روزی: ۰۲۱-۸۸۸۶۲۰۸۵

FarmaSOS.com

# Everything from A to Z

## Index

### A

- ABS Antilock Brake System [77](#)
- indicator lamp [77](#)
- Acceleration assistant [54](#)
- Accessories, refer to Your individual vehicle [5](#)
- "Activation time" for independent ventilation [95](#)
- Active cruise control [59](#)
- malfunctions [64](#)
- Active head restraints, front [40](#)
- Active roll stabilization [80](#)
- Active seat [42](#)
- Active seat ventilation [42](#)
- Active steering [82](#)
- Adaptive Head Light [88](#)
- "Address book" for navigation [120](#)
- Address for navigation
  - deleting [120](#)
  - entering [116](#)
  - selecting [120](#)
- "Add to address book" for navigation [120](#)
- "Add to destination list" [118](#)
- Adjusting temperature for upper body [93](#)
- Adjusting the thigh support [37](#)
- "After door is opened" [39](#)
- "After unlocking" [39](#)
- Airbags [83](#)
- indicator lamp [84](#)
- sitting safely [36](#)
- Air circulation, refer to Recirculated air [91](#)
- Air distribution
  - automatic [91](#)
  - individual [93](#)
- Air flow, refer to Air volume [91](#)
- Airing, refer to Ventilation [94](#)
- "Air recirculation on / off" [44](#)
- Air vent outlets of automatic climate control [90](#)
- Air volume [91](#)
- AKI, refer to Fuel specifications [169](#)
- Alarm system [32](#)
- avoiding unintentional alarms [33](#)
- All around the steering wheel [10](#)
- "All channels" [138](#)
- "All doors" [28](#)
- All-season tires, refer to Winter tires [175](#)
- "AM", wave-band [130, 134](#)
- Antenna for portable phone [150](#)
- Antifreeze
  - coolant [179](#)
  - washer fluid [57](#)
- Anti-theft system [27](#)
- Anti-trapping mechanism
  - glass roof [35](#)
  - windows [34](#)
- Approved axle loads, refer to Weights [200](#)
- Approved gross vehicle weight, refer to Weights [200](#)
- Arrival time, refer to Computer [71](#)
- Ashtray
  - front [99](#)
  - rear [100](#)
- Assistance window [18](#)
- Assisting systems, refer to DSC Dynamic Stability Control [78](#)
- AUC Automatic recirculated-air control [91](#)
- "Audio" [131](#)
- Audio [130](#)
- adjusting the tone [131](#)
- controls [130](#)
- switching on/off [130](#)
- volume [131](#)
- Audio systems, refer to Tone control [131](#)
- Automatic
  - air distribution [91](#)
  - air volume [91](#)
  - cruise control [58, 59](#)
  - storing stations [135](#)
- Automatic car wash, refer to Caring for your vehicle brochure
- Automatic climate control [90](#)
- automatic air distribution [91](#)
- settings using the Control Center [92](#)
- switching off [92](#)
- Automatic curb monitor [39](#)
- Automatic headlamp control [87](#)
- "Automatic programs" [93](#)
- Automatic recirculated-air control AUC [91](#)
- Automatic steering wheel
  - adjustment [43](#)

Automatic transmission  
 with Steptronic 54  
 - indicator lamp 56  
 - interlock 49  
 - selector lever interlock 55  
 - shiftlock 55  
 - sport program 55  
 - starting the engine 50  
 - towing 193

AUTO program, refer to  
 Automatic air distribution  
 and volume 91

"Autostore" on the  
 radio 136

"AUTO" with automatic  
 climate control 93

Average fuel  
 consumption 70  
 - setting the units 74

Average speed 70

"Avoid ferries" for  
 navigation 121

"Avoid freeways / tolls" for  
 navigation 121

Avoiding unintentional  
 alarms 33

"Avoid tollroads" for  
 navigation 121

Axle loads, refer to  
 Weights 200

"A - Z" 154

## B

Backrests, refer to  
 Seats 36

Backrest width  
 adjustment 37

Backup lamps, refer to  
 Reverse gear 51  
 - replacing the bulbs 186

"Balance", audio  
 system 132

Balance, refer to Tone  
 control 131

"Bass", audio system 132

Bass, refer to Tone  
 control 131

Battery 188

- in the remote control 26

- jump-starting 192

Belts, refer to Safety  
 belts 36, 40

Beverage holders 99

Black ice, refer to Ice  
 warning 65

Blocking sections of a route  
 for navigation 125

Blower, refer to Air  
 volume 91

BMW Assist 161

- enabling 161  
 - services offered 162

"BMW Info" 163

BMW Maintenance  
 System 181

"BMW Service  
 settings" 161

Bore, refer to Engine  
 data 198

Bottle holder, refer to  
 Beverage holders 99

Brake Assistant, refer to  
 DBC Dynamic Braking  
 Control 79

Brake fluid 180  
 - indicator lamp 180

- level 180  
 - replacing 180

Brake force display 82

Brake hydraulic  
 systems 180

Brake lamps, replacing the  
 bulbs 186

Brake pads 107

- breaking-in  
 procedure 106

Brake pedal, refer to  
 Brakes 107

Brake rotors 107

Brakes 107

- ABS 77  
 - brake fluid 180

- breaking-in  
 procedure 106

- handbrake 50

Brake system 106

- brake-fluid level 180

- brake pads 107

- breaking-in  
 procedure 106

- disc brakes 107

- indicator lamp 13, 107

Breakdown services, refer  
 to Roadside  
 Assistance 191

Break-in procedures 106

- brakes 106

- clutch 106

- differential 106

- engine 106

Brightness on the Control  
 Display 73

Bulbs and lamps

- replacing the bulbs 184

Buttons on steering  
 wheel 11

## C

California Proposition  
 65 Warning 183

"Call" 154

Call

- accepting 153

- display accepted 154

- ending 154

- in absence 154

- starting 153

Calling

- from phone book 154

- from the Top 8 list 154

- redialing 154

Calling up traffic  
 information 126

"Call sender" 156

"Call Sirius" 138

Can holder, refer to  
 Beverage holders 99

Capacities 201

Car battery, refer to  
 Battery 188

Car care, refer to Caring for  
 your vehicle brochure

Car-care products, refer to  
 Caring for your vehicle  
 brochure

- Cargo, securing **109**
- Cargo area
  - locking separately **31**
- Caring for artificial leather, refer to Caring for your vehicle brochure
- Caring for leather, refer to Caring for your vehicle brochure
- Caring for light-alloy wheels, refer to Caring for your vehicle brochure
- Caring for plastic, refer to Caring for your vehicle brochure
- Caring for the carpet, refer to Caring for your vehicle brochure
- Caring for the vehicle finish, refer to Caring for your vehicle brochure
- Car jack
  - jacking points **188**
- Car keys, refer to Central keys with remote control **26**
- Car phone **151**
  - installation location, refer to Center armrest **98**
  - refer to Portable phone **150**
  - refer to separate Owner's Manual
- Car radio, refer to Radio **134**
- Car wash **106**
  - refer also to Caring for your vehicle brochure
- Catalytic converter, refer to High temperatures **106**
- "Categories" **138**
- CBC Cornering Brake Control **78**
- CBS Condition Based Service **181**
- "CD" **130**
- CD changer **144**
  - adjusting the tone **131**
  - controls **130**
  - fast forward/reverse **146**
  - installation location **144**
  - listening to a CD **144**
  - playing a track **145**
  - random order **146**
  - repeating a track **145**
  - selecting track **145**
  - switching on/off **130**
  - volume **131**
- CD for navigation **114**
- CD player **141**
  - adjusting the tone **131**
  - controls **130**
  - fast forward/reverse **142**
  - playing a track **142**
  - random order **142**
  - repeating a track **142**
  - selecting tracks **141**
  - switching on/off **130**
  - volume **131**
- Center armrest **98**
- Center console, refer to Comfort area **14**
- Central keys with remote control **26**
  - "Central locking" **38**
- Central locking system **27**
  - from inside vehicle **30**
  - from outside vehicle **27**
- Changes, technical, refer to Parts and accessories **6**
- Changing a wheel **187**
- Changing selector-lever positions **55**
- Changing the direction display for navigation **124**
- Changing the language on the Control Display **74**
- Changing the measurement units on the Control Display **74**
- Changing wheels **174**
- CHECK button **69**
- Check Control **68**
- "Check Control messages" **69**
- Check Gas Cap **168**
- Checking the air pressure, refer to Tire inflation pressure **170**
- Child's seat **45**
- Child-restraint fixing LATCH **47**
- Child restraints **45**
- Child-restraint system **45**
- Child-safety lock **48**
- Chock **187**
- Chrome parts, care, refer to Caring for your vehicle brochure
- Cigarette lighter **100**
- Circulation of air, refer to Recirculated-air mode **91**
- "City" for destination entry **117**
- Cleaning, refer to Caring for your vehicle brochure
- Cleaning headlamps
  - washer fluid **57**
- Cleaning windshield **57**
- "Climate" **41**
- Clock **65**
  - 12/24 hour mode **74**
  - setting the time and date **74**
- Closing
  - from inside **30**
  - from outside **27**
- Cockpit **10**
- Comfort area **14**
- Comfort seat **37**
- "Communication" **152**
- "Communication interface" **161**
- Compact Disc
  - refer to CD changer **144**
  - refer to CD player **141**
- Compact wheel
  - inflation pressure **171**
  - wheel change **187**
- Compression ratio, refer to Engine data **198**
- Computer **70**
  - clock, 12/24 hour mode **74**
  - displays on the Control Display **70**

- Condition Based Service CBS **181**
- "Confirmation" **28**
- Confirmation signals for vehicle locking **28**
- "Confirm unlock code" **153**
- Connecting a vacuum cleaner, refer to Lighter socket **100**
- Consumption display
  - refer to average fuel consumption **70**
- Consumption indicator
  - refer to Energy Control **66**
- "Continue guidance to dest.?" **126**
- Control Center **16**
  - adjusting the brightness **73**
  - assistance window **18**
  - automatic climate control **92**
  - changing settings **73**
  - changing the menu page **19**
  - confirming selection or entry **19**
  - display, menus **16**
  - language selection **74**
  - lists **19**
  - menu item selection **19**
  - selecting units of measure and display format **74**
  - setting time and date **74**
  - status information **18**
  - symbols **17**
- Control Display **16**
- Controller, refer to Control Center **16**
- Controls, audio systems **130**
- Controls, refer to Cockpit **10**
- Convenience operation
  - glass roof **28**
  - windows **28**
- Convenience start, refer to Starting the engine **49**
- Coolant **179, 180**
  - level **180**
- Cooling, maximum **91**
- Cornering Brake Control **78**
- "Country" for destination entry **117**
- Country of destination for navigation **116**
- Courtesy lighting **89**
- Cruise control **58**
  - active cruise control **59**
  - indicator lamp **11**
- Cruising range **70**
- Cup holder, refer to Beverage holders **99**
- Curb weight, refer to Weights **200**
- Current fuel consumption **66**
- "Current position" **115**
- "Customer Relations" **163**
- Cylinders, refer to Engine data **198**
- D**
- Dashboard, refer to Cockpit **10**
- Data **198**
  - capacities **201**
  - dimensions **199**
  - engine **198**
  - weights **200**
- Date **65**
  - calling up **65**
  - display format **75**
  - setting **75**
- Daytime driving lamps **87**
- DBC Dynamic Brake Control **79**
  - indicator lamp **79**
- Decommissioning the vehicle, refer to Caring for your vehicle brochure
- Defect
  - automatic transmission **56**
  - door lock **29**
  - fuel filler door **168**
  - glass roof **35**
  - luggage compartment lid **31**
  - Sequential manual transmission SMG **53**
- Defrosting the windshield, refer to Defrosting windows **91**
- Defrosting windows and removing condensation **91**
- Defrost position, refer to Defrosting windows **91**
- "Delete address book" for navigation **121**
- "Delete all numbers" on the portable phone **155**
- "Delete data" for navigation **121**
- "Delete" for portable phone **155**
- Deleting the destination address **120**
- Destination for navigation
  - entry **116**
  - recent destinations **119**
  - selecting via map **118**
  - selecting with information **118**
  - storing **120**
- Destination guidance **123**
  - changing specified route **121**
  - interrupting voice instructions **125**
  - selecting a new route **125**
  - terminating/continuing **126**
  - volume of voice instructions **125**
- "Detour" **126**
- "Dial number" **153**
- Digital clock **65**
- Dimensions **199**
- Dipstick for engine oil **178**
- Directional indicators, refer to Turn signal indicators **56**
- Direction announcements, refer to Voice instructions **124**
- Direction instructions, refer to Voice instructions **124**
- Directory, refer to Phone book **154**

Directory for navigation, refer to Address book **120**

Disc brakes **107**

Displacement, refer to Engine data **198**

Display lighting **88**

Displays

- refer to Cockpit **10**
- refer to Control Display **17**
- refer to Instrument cluster **12**

Displays on the windshield, refer to Head-Up Display **85**

Disposal

- brake fluid **180**
- coolant **179**
- engine oil **179**
- vehicle battery **189**

Distance, refer to Computer **71**

Distance cruise control, refer to Active cruise control **59**

"Distance to destin." **71**

Distance to destination, refer to Computer **71**

Distance warning, refer to Park Distance Control **76**

Divided rear seat back, refer to Fold down rear seat **101**

Door entry lighting **89**

Door keys **26**

Door lock **29**

"Door locks" **28**

Doors

- manual operation **29**
- remote control **28**

DOT Quality Grades **173**

Draft-free ventilation **94**

"Driver" **42**

"Driver's door only" **28**

Driving light, refer to Parking lamps/low beams **87**

Driving notes **106**

Driving stability control **78**

Driving tips, refer to Driving notes **106**

Dry air, refer to Cooling function **91**

Drying the air, refer to Cooling function **91**

DSC Dynamic Stability Control **78**

- indicator lamp **78**

DTC Dynamic Traction Control **79**

- indicator lamp **79**

DVD for navigation **114**

Dynamic Brake Control **79**

- indicator lamp **79**

Dynamic Driving Control **54**

"Dynamic route" for navigation **121**

Dynamic Stability Control **78**

- indicator lamp **78**

Dynamic Traction Control **79**

- indicator lamp **79**

**E**

EBV Electronic Brake Force Distribution **78**

"Edit" on the portable phone **154**

Electrical malfunction

- door lock **29**
- fuel filler door **168**
- glass roof **35**
- luggage compartment lid **31**

Electrical power windows, refer to Windows **33**

Electronic Brake Force Distribution EBV **78**

Electronic Stability Program ESP, refer to DSC Dynamic Stability Control **78**

Emergency assistance, refer to Roadside Assistance **191**

Emergency call **190**

Emergency operation, refer to Manual operation

Emergency release of luggage compartment lid from luggage compartment's interior **32**

Emergency services, refer to Roadside Assistance **191**

"Emission inspect." **67, 67**

"Enable services" **162**

"End call" **154**

Energy-conscious driving, refer to Energy Control **66**

Energy Control **66**

Engine

- breaking-in procedure **106**
- data **198**
- speed **198**
- starting **49**

Engine compartment **178**

Engine coolant **179**

Engine hood **177**

Engine oil

- adding **179**
- checking the oil level **178**
- prescribed oils **179**

Engine output, refer to Engine data **198**

Engine speed **198**

"Enter address" **116**

Entering destination **117**

Entering house number or intersection **117**

Entering switch-on times of independent ventilation/heating **95**

Entering the address **116**

Entering the intersection **117**

Entering the town/city for navigation **117**

Entering zip code for navigation **117**

"Entertainment" **130**

"Entertainment settings" **131**

"Equalizer" **133**

"Equalizer", audio systems **131**



ESP Electronic Stability Program, refer to DSC Dynamic Stability Control **78**

Exhaust system, refer to High temperatures **106**

Exterior mirrors **42**  
- automatic dimming feature **43**

## F

"Fader", audio systems **132**

Failure messages, refer to Check Control **68**

False alarms, refer to Avoiding unintentional alarms **33**

False alarms with the Flat Tire Monitor **80**

Fastening safety belts, refer to Safety belt  
- indicator lamp **40**

"Fastest route" for navigation **121**

Fastest route for navigation **121**

First aid, refer to First aid kit **191**

First aid kit **191**

Fitting for towing **193**

Flashlight, refer to Rechargeable flashlight **98**

Flash when locking/unlocking **28**

Flat tire

- compact wheel **187**

- Flat Tire Monitor **81**

- refer also to Changing a wheel **187**

- refer also to Tire condition **173**

- run-flat tires **81, 175**

Flat Tire Monitor **80**

- false alarms **80**

- indicator lamp **81**

- initializing the system **81**

- malfunctions **82**

Floods, refer to Water on the road **107**

"FM", waveband **130, 134**

FM, waveband **134**

Fog lamps **89**

- indicator lamp **89**

Fold down rear seat **101**

Folding rear seat back **101**

Footwell lamps **89**

Forward, fast

- CD changer **146**

- CD player **142**

For your own safety **6**

Front airbags **83**

Front armrest **98**

Front head restraints **40**

Front seat adjustment **36**

Front-to-rear adjustment in Audio mode **132**

"FTM" **81**

Fuel **169**

- display **66**

- quality **169**

- tank volume **66**

Fuel clock, refer to Fuel gauge **66**

Fuel display, refer to Fuel gauge **66**

Fuel filler door **168**

- releasing in the event of electrical malfunction **168**

Fuel specifications **169**

Fuses **189**

Garage door opener, refer to Integrated universal remote control **96**

Gasoline, refer to Fuel quality **169**

Gasoline display, refer to Fuel gauge **66**

Gear changes, refer to Automatic transmission with Steptronic **55**

Gear display **54**

Gearshift lever

- automatic transmission with Steptronic **55**

- manual transmission **51**

- Sequential manual transmission SMG **51**

General car care, refer to Caring for your vehicle brochure

General driving notes **106**

Glass roof, electrical **34**

- closing in the event of an electrical defect **35**

- convenience operation **29**

- remote control **28**

Glove compartment **98**

- lighting **98**

GPS navigation, refer to Navigation system **114**

Grilles of the automatic climate control **90**

Gross vehicle weight, refer to Weights **200**

## H

Halogen lamps **185**

Handbrake **50**

- indicator lamp **50**

Hands-free unit **151**

Hazard warning flashers **14**

Head airbags **83**

Headlamp control, automatic **87**

Headlamp flasher **56**

Headlamps **87**

- care, refer to Caring for your vehicle brochure

- replacing the bulbs **185**

Headlamp washers **57**

Head Light, refer to

Adaptive Head Light **88**

Head restraints **39**

- front **39**

- front, active **40**

- rear **40**

"Head-Up Display" **44**

Head-Up Display **85**

Heated mirrors **43**

Heated rear window **91**

Heated seats **41**

Heated steering wheel **44**

"Heated steering wheel on/off" **44**

Heater, rear window **91**

Heating 90  
 - mirrors 43  
 - steering wheel 44  
 Heating while stopped 92  
 Heavy cargo, refer to  
 Stowing cargo 109  
 Height, refer to  
 Dimensions 199  
 Height adjustment  
 - head restraints 39  
 - seats 37  
 - steering wheel 43  
 High beams 88  
 - headlight flasher 88  
 - indicator lamp 13  
 - replacing the bulbs 185  
 Hills 107  
 Holder for beverages 99  
 "Horn" 44  
 Horn 10  
 "Hour memo" 75  
 "House number" for  
 destination entry 117  
 Hydraulic brake assistant,  
 refer to DBC 79  
 Hydroplaning 106, 174

## I

Ice warning 65  
 iDrive, refer to Control  
 Center 16  
 Ignition key 26  
 Ignition key positions, refer  
 to Ignition lock 49  
 Ignition lock 49  
 Independent ventilation  
 - switching on and off  
 directly 94  
 Independent ventilation/  
 heating  
 - entering switch-on  
 times 95  
 - preselecting switch-on  
 times 95

Indicator/warning lamp  
 - active steering 82  
 - airbags 84  
 - Flat Tire Monitor 81  
 - front fog lamps 11  
 - overview 13  
 - safety belt warning 40  
 Individual air distribution 93  
 Individual button  
 assignment options on  
 steering wheel 44  
 Individual settings, refer to  
 Key Memory 26  
 Inflation pressure, refer to  
 Tire inflation  
 pressure 170  
 "Information" for  
 navigation 118  
 Information for navigation  
 - on a different city 118  
 - on city of destination 118  
 - on current position 118  
 "Information on  
 destination" 119  
 "Input map" 118  
 Installation location  
 - CD changer 144  
 - navigation computer 114  
 - portable phone 151  
 Instructions for navigation  
 system, refer to Voice  
 instructions 124  
 Instrument cluster 12  
 Instrument combination,  
 refer to Instrument  
 cluster 12  
 Instrument lighting 88  
 Instrument panel, refer to  
 Instrument cluster 10  
 Integrated universal remote  
 control 96  
 Interesting destination 118  
 "Interim time" 73  
 Interior lamps 89  
 - remote control 28  
 Interior mirror, refer to  
 Interior rearview mirror 43  
 Interior motion sensor 33  
 - switching off 28

Interior rearview mirror 43  
 - automatic dimming  
 feature 43  
 Interlock, refer to Steering  
 locked 49  
 Intermittent mode of the  
 wipers 57

## J

Jacking points 188  
 Joystick, refer to Control  
 Center 16  
 Jump-starting 192

## K

Key Memory 26  
 "Keypad" 156  
 Keys 26  
 Key set, refer Central keys  
 with remote control 26  
 Kickdown 55  
 Knock control 169

## L

Lamps and bulbs 184  
 "Languages" 74  
 "Languages" for  
 navigation 124  
 Lashing eyes, refer to  
 Securing the load 109  
 "Last seat position" 38  
 LATCH child-restraint  
 fixing 47  
 LEDs light-emitting  
 diodes 89  
 Length, refer to  
 Dimensions 199  
 Letter symbol on portable  
 phone 156  
 License plate light  
 - replacing the bulbs 186  
 Light-emitting diodes  
 LEDs 89  
 Lighter 100  
 - socket 100  
 "Lighting" 56, 87

Lighting  
 - instruments **88**  
 - of the vehicle, refer to Lamps **87**

Lighting of the instruments, refer to Instrument lighting **88**

Lights, refer to Parking lamps/low beams **87**

Lights on warning **87**

Light switch **87**

Limit speed, refer to Limit **72**

Loading  
 - securing the load **109**  
 - stowing cargo **109**  
 - vehicle **108**

"Lock after driving off" **30**

"Lock button" **28**

Locking  
 - from inside **30**  
 - from outside **28**

Locking and unlocking doors  
 - from inside **30**  
 - from outside **27**  
 - setting confirmation signals **28**

"LOGIC7", audio systems **132**

Low beams **87**  
 - automatic **87**  
 - replacing the bulbs **185**

Lower back support, refer to Lumbar support **38**

Lug bolts **188**  
 - wrench **187**

Luggage compartment **31**  
 - capacity **200**  
 - locking separately **31**  
 - opening/closing, refer to Luggage compartment lid **31**  
 - opening from the inside **31**  
 - opening from the outside **31**  
 - opening with remote control **28**  
 - socket **100**  
 - volume **200**

Luggage compartment lid **31**  
 - emergency release from inside luggage compartment **32**  
 - locking separately **31**  
 - manual operation **31**  
 - opening from the inside **31**  
 - opening from the outside **31**  
 - opening with remote control **28**  
 - unlocking manually **31**

Luggage rack, refer to Roof-mounted luggage rack **109**

Lumbar support **38**

LW, waveband **134**

## M

M+S tires, refer to Winter tires **175**

Maintenance, refer also to Service and Warranty Information Booklet for US models or Warranty and Service Guide, شیبانه روزی - ۰۲۱  
 Booklet for Canadian models

Maintenance system **181**

Malfunction  
 - automatic transmission **56**  
 - Sequential manual transmission SMG **53**

Malfunction warnings, refer to Check Control **68**

Manually controlled recirculated air **91**

"Manual" on the radio **135**

Manual operation  
 - door lock **29**  
 - fuel filler door **168**  
 - glass roof **35**  
 - luggage compartment lid **31**

Manual operation with automatic transmission **55**

Manual release, refer to Manual operation

Manual station tuning **135**

Manual transmission **51**

"Map, arrow display" **123**

"Map, direction of travel" **124**

"Map, facing north" **124**

Maximum cooling **91**

Maximum roof weight **200**

Maximum speed  
 - for winter tires **175**  
 - with compact wheel **188**

Memory  
 - refer to Key Memory **26**  
 - refer to Seat, mirror and steering wheel memory **38**

Menus, refer to Control Center **16**

Message list of traffic information **126**

Microphone for hands-free system **151**

Mirrors **42**  
 - automatic curb monitor **39**  
 - dimming feature **43**  
 - heating **43**  
 - memory, refer to Seat, mirror and steering wheel memory **38**

"Missed calls" **155**

Missed calls **154**

Mobile communications in the vehicle **108**

Mobile Service, refer to Roadside Assistance **191**

Monitor, refer to Control Center **16**

"Monitor display on" **77**

Monitoring inflation pressure, refer to Flat Tire Monitor **80**

Multifunction switch  
 - refer to Turn signal indicators/headlamp flasher **56**  
 - refer to Wiper/washer system **57**

Music track  
 - find [142](#), [145](#)  
 "Mute on / off" [44](#)  
 MW, waveband [134](#)

## N

"Navigation" [44](#), [114](#)  
 Navigation, refer to  
     Navigation system [114](#)  
 Navigation CD/DVD [114](#)  
 Navigation computer,  
     installation location [114](#)  
 Navigation destination  
     - manual entry [116](#)  
 Navigation system [114](#)  
     - address book [120](#)  
     - current position [115](#)  
     - destination guidance in  
         assistance window [115](#)  
     - destination input [116](#)  
     - destination list [119](#)  
     - entering a destination  
         manually [116](#)  
     - navigation CD/DVD [114](#)  
     - recent destinations [119](#)  
     - route display [123](#)  
     - route list [124](#)  
     - selecting destination  
         using information [118](#)  
     - selecting route  
         criteria [121](#)  
     - starting [114](#)  
     - starting destination  
         guidance [123](#)  
     - switching off, refer to  
         Terminating/continuing  
         destination guidance [126](#)  
     - terminating/continuing  
         destination guidance [126](#)  
     - voice instructions [124](#)  
     - volume adjustment [125](#)  
 "Navigation voice  
     instructions on" [124](#)  
 Neck support, refer to Head  
     restraints [39](#)  
 "New destination" [116](#), [118](#)  
 "New route" [125](#)  
 "Next entertainment  
     source" [44](#)

North alignment of map for  
     navigation [124](#)  
 Nozzles, refer to  
     Windshield washer  
     nozzles [57](#)  
 "Number" on portable  
     phone [153](#)

## O

OBD connector [183](#)  
 Octane numbers, refer to  
     Fuel quality [169](#)  
 Odometer [65](#)  
 Oil  
     - additives [179](#)  
     - capacity [201](#)  
     - dipstick [178](#)  
     - specified engine oils [179](#)  
 Oil change interval,  
     refer to Service  
     requirement display [66](#)  
 Oil consumption [178](#)  
 Oil level [178](#)  
 Old batteries, refer to  
     Disposal [189](#)  
 "On a new destination" for  
     navigation [119](#)  
 "Onboard info" [71](#)  
 Onboard monitor, refer to  
     Control Center [16](#)  
 Onboard tool kit [184](#)  
 "On destination" [119](#)  
 "On location" [119](#)  
 Opening and closing  
     - from inside [30](#)  
     - from outside [27](#)  
     - using the door lock [29](#)  
     - using the remote  
         control [27](#)

Operation via voice for  
     portable phone [157](#)  
     - adjusting volume [158](#)  
     - canceling [157](#)  
     - correcting phone  
         number [158](#)  
     - correcting unlock  
         code [158](#)  
     - dialing phone number [158](#)  
     - entering unlock code [158](#)  
     - placing a call [158](#)  
     - redialing [159](#)  
     - switching on phone [158](#)  
     - voice commands [157](#)  
     - voice phone book [158](#)  
 Orientation menu, refer to  
     Start menu [17](#)  
 Output, refer to Engine  
     data [198](#)  
 Outside air, refer to  
     Recirculated-air mode [91](#)  
 Outside temperature  
     display [65](#)  
     - changing the  
         measurement unit [74](#)  
     - in the computer [74](#)

## P

Panic mode [28](#)  
 Park Distance Control  
     PDC [76](#)  
 Parking  
     - vehicle [50](#)  
 Parking aid, refer to Park  
     Distance Control PDC [76](#)  
 Parking brake, refer to  
     Handbrake [50](#)  
 Parking lamp  
     - replacing the bulbs [185](#)  
 Parking lamps/low  
     beams [87](#)  
     - replacing the bulbs [185](#)  
 "Parking lamps on!" [69](#)  
 Parts and accessories,  
     refer to Your individual  
     vehicle [5](#)  
 "Passenger" [42](#)  
 Passenger-side mirror tilt  
     function [39](#)  
 "Pathway lighting" [87](#)

Pathway lighting **87**  
 "PDC" **77**  
 PDC Park Distance  
   Control **76**  
 "Phone" **152**  
 Phone book **152**  
 Phone numbers  
   - deleting in the phone  
     book **155**  
   - dialing **153**  
   - most recent numbers **154**  
   - selecting in the phone  
     book **154**  
   - Top-8 **154**  
 Please fasten safety belt  
   warning lamp **41**  
 Portable phone  
   - accepted calls **154**  
   - adjusting volume **152**  
   - calling **153**  
   - call termination **154**  
   - controlling with the  
     buttons on the steering  
     wheel **11**  
   - entering unlock code **152**  
   - hands-free system **151**  
   - installation location, refer  
     to Center armrest **98**  
   - missed calls **154**  
   - phone book **154**  
   - redialing **154**  
   - refer to separate Owner's  
     Manual  
   - SMS **156**  
   - Top-8 **154**  
   - touch tone redialing **156**  
 Portable phone, refer to  
   separate Owner's Manual  
 Portable phone battery **151**  
 Portable phone codes **152**  
 Portable phone in  
   vehicle **108**  
 Portable phones, use in the  
   interior, refer to Mobile  
   communications in the  
   vehicle **108**  
 Position  
   - displaying **115**  
 "Presets" on the  
   radio **134, 138**  
 Pressure, tires **170**

Pressure monitoring,  
   tires **80**  
 "Profile" **165**  
 Programming button  
   function **44**  
 Programming buttons on  
   steering wheel **44**

## R

Radio  
   - adjusting the tone **131**  
   - autostore **135**  
   - controls **130**  
   - play station **135**  
   - satellite radio **138**  
   - selecting the  
     waveband **130, 134**  
   - station search **136**  
   - station selection **134**  
   - station with the best  
     reception **135**  
   - store station **136**  
   - switching on/off **130**  
   - volume **131**  
   - Weather Band **137**  
 Radio-control key, refer to  
   Central key with remote  
   control **26**  
 Rain sensor **57**  
 "Random", random  
   sequence  
   generator **142, 146**  
 Random play  
   - CD changer **146**  
   - CD player **142**  
 Reading lamps **89**  
 Rear armrest **101**  
 Rear center armrest **101**  
 Rear head restraints **40**  
 Rear lamps  
   - replacing the bulbs **186**  
 Rear seat back, folding **101**  
 Rear seats  
   - folding backrests **101**  
   - head restraint  
     adjustment **40**  
   - heating **41**  
 Rear ventilation **94**  
 Rearview mirror **42**

Rear window blind, refer to  
   Roller sun blinds **97**  
 Rear window safety  
   switch **34**  
 "Received calls" **155**  
 Receiving level of portable  
   phone, refer to Status  
   information **18**  
 Recent destinations **119**  
 Recent portable phone  
   numbers **154**  
 Reception  
   - quality **137**  
   - radio stations **137**  
   - regional  
     program **135**  
 Recirculated air **91**  
 Reclining seat, refer to  
   Backrest **37**  
 Recording times, refer to  
   Stopwatch **73**  
 "Redial" for portable  
   phone **155**  
 Redialing with portable  
   phone **154**  
 Refueling **168**  
 "Relock door if not  
   opened" **30**  
 Remaining distance **71**  
 Remote control **26**  
   - garage-door opener **96**  
   - luggage compartment  
     lid **28**  
   - malfunctions **29**  
 "Repeat" on the  
   radio **142, 145**  
 Replacement fuses **189**  
 Replacement keys **29**  
 Replacement of  
   wheels **174**  
 Replacing bulbs, refer to  
   Lamps and bulbs **184**  
 Replacing wheels/tires **174**  
 Reporting an accident,  
   refer to Starting an  
   emergency call **190**  
 Reporting safety defects **7**  
 Reserve warning, refer to  
   Fuel gauge **66**  
 "Reset" for stopwatch **73**  
 Residual heat **92**

- Restraint systems, refer to  
 Safety belts **40**  
 Reverse, fast  
 - CD changer **146**  
 - CD player **142**  
 Reverse gear  
 - automatic transmission with Steptronic **55**  
 - manual transmission **51**  
 - Sequential manual transmission SMG **52**  
 Right/left balance adjustment in audio mode **132**  
 "Roadside Assistance" **162**  
 Roadside Assistance **191**  
 "Roaming" **165**  
 Roller sun blinds **97**  
 Roof-mounted luggage rack **109**  
 Route **123**  
 - changing **121**  
 - display **123**  
 - list **124**  
 - map cancellation **123**  
 - map display **124**  
 - new **125**  
 - selecting **121**  
 - selecting criteria **121**  
 Route announcements, refer to Voice instructions **124**  
 Route guidance, refer to Destination guidance **123**  
 "Route list" for navigation **124**  
 Route map **123**  
 Route selection **121**  
 Run-flat tires **175**  
 - continuing driving with a damaged tire **175**  
 - flat tire **81**  
 - tire inflation pressure **175**  
 - tire replacement **174**
- S**
- Safety belts **36, 40**  
 - damage **41**  
 - sitting safely **36**  
 - warning lamp **40**
- Safety belt tensioners, refer to Safety belts **36, 40**  
 Safety feature  
 - glass roof, electrical **35**  
 - windows **34**  
 Safety lock buttons **30**  
 Safety systems **78**  
 - ABS Antilock Brake System **77**  
 - airbags **83**  
 - safety belts **40**  
 Satellite radio **138**  
 - activating **138**  
 - selecting channel **138**  
 - storing channel **138**  
 "SAT" for radio **138**  
 Scan  
 - CD changer **145**  
 - CD player **142**  
 - radio **136**  
 "Scan", playing stations **135**  
 "Scan", playing tracks **142, 145**  
 Screen, refer to Control Display **16**  
 "Screen on / off" **44**  
 "Seat heater distribution" **41**  
 Seats **36**  
 - adjusting comfort seat **37**  
 - adjusting sports seat **37**  
 - adjusting the seats **37**  
 - heating **41**  
 - memory, refer to Seat, mirror and steering wheel memory **38**  
 - sitting safely **36**  
 - storing the setting **38**  
 - ventilation, refer to Active seat ventilation **42**  
 Securing cargo, refer to Cargo **109**  
 Securing the load **102**  
 "Select as destination" **119**  
 Select "BMW Service" **162**  
 "Select current speed" **73**  
 Selecting a new route for navigation system **125**  
 Selecting audio sources **130**
- Selecting new scale for navigation system display **124**  
 Selecting route **121**  
 Selecting "Route preference" **121**  
 Selection options with navigation system **121**  
 Selector lever  
 - automatic transmission with Steptronic **55**  
 - Sequential manual transmission SMG **52**  
 Selector lever lock, refer to Changing selector-lever positions **55**  
 Selector-lever positions  
 - automatic transmission with Steptronic **55**  
 - manual transmission **51**  
 - SMG Sequential manual transmission **52**  
 Sequential manual transmission SMG **51**  
 "Service" **66, 162**  
 Service, refer to Roadside Assistance **191**  
 Service Interval Display **66**  
 "Service notification" **162**  
 "Service Request" **163**  
 "Service requirements" **66, 162**  
 "Service Status" **162**  
 "Set date" **75**  
 "Set service date" **67**  
 Setting road-speed limit **72**  
 Settings  
 - changing on the Control Display **73**  
 - configuring, refer to Key Memory **26**  
 Setting the time, refer to Preselecting switch-on times **95**  
 Shifting gears with automatic transmission with Steptronic **55**  
 Shiftlock, refer to Changing selector-lever positions **55**

"Shortest route" for navigation 121  
Shortest route for navigation 121  
Shoulder support 37  
"Show current position" 118  
"Show destination position" 118  
Side airbags 83  
Side marker lamps, replacing the bulbs 186  
Side turn signal indicators, replacing the bulbs 186  
Side window blind, refer to Roller sun blinds 97  
Sitting safely  
– with airbags 36  
– with safety belts 36  
Ski bag 101  
Sliding/tilt sunroof, refer to Glass roof, electric 34  
SMG Sequential manual transmission 51  
"SMS" 156  
Snow chains 176  
Socket  
– for Onboard Diagnosis interface 183  
– in front passenger footwell 100  
– in luggage compartment 100  
– refer to Lighter socket 100  
SOS, refer to Starting an emergency call 190  
Sound control, refer to Tone control 131  
Spare fuses 189  
Spare key 26  
Spare wheel, refer to Compact wheel 187  
Special oils, refer to Specified engine oils 179  
Specified engine oils 179  
Speed  
– winter tires 175  
– with compact wheel 188  
Speed-dependent volume 132

Speedometer 12  
"Speed volume", audio systems 132  
Sport program  
– Dynamic Driving Control 54  
Sports seat 37  
Stability control, refer to Driving stability control 77  
Standard default settings, audio systems 133  
Standing lamps 88  
"Start" for stopwatch 73  
"Start guidance" 118  
Starting, refer to Starting the engine 49  
Starting assistance, refer to Jump-starting 192  
Starting destination guidance 123  
Starting difficulties  
– at very low temperatures 49  
Starting the engine 49  
Start menu on the Control Display 17  
"Start service" 163  
Start-up difficulties  
– jump-starting 192  
Station, refer to Radio 134  
"Status" 66  
Status 67  
Status of this Owner's Manual at time of printing 5  
Steering wheel 11  
– adjustment 43  
– buttons on the steering wheel 11  
– heating 44  
– individual button assignment options 44  
– memory 38  
"Steering wheel buttons" 44  
Steering with variable ratio, refer to Active steering 82  
Steptronic, refer to Automatic transmission with Steptronic 54

"Stop" for stopwatch 73  
"Stopwatch" 73  
Stopwatch 73  
Storage compartments 99  
"Store address" for navigation 120  
"Store" on the radio 136  
Storing sitting position, refer to Seat, mirror and steering wheel memory 38  
Storing tires 175  
Straps, refer to Loading 109  
"Street" for destination entry 117  
Stroke, refer to Engine data 198  
Summer tires, refer to Wheels and tires 170  
Sun blinds 97  
SW, waveband 134  
Switches, refer to Cockpit 10  
Switching off engine 50  
Switching off the tilt alarm sensor 28  
Switching on/off audio 130  
– CD changer 130  
– CD player 130  
– cooling function 91  
– navigation voice instructions 124  
– portable phone 151  
– radio 130  
Swiveling headlamps, refer to Adaptive Head Light 88  
Symbols 4

## T

Tachometer 65  
Tail lamps  
– replacing the bulbs 186  
Target cursor for navigation 118  
Technical data 198  
Telematic 161  
Telephone, refer to Portable phone 150

- TeleService 161
- enabling 161
- services offered 162
- Temperature display
- ice warning 65
- outside temperature 65
- setting the units 74
- "Terminate services" 165
- "Text language" 74
- The BMW Maintenance System 181
- Tightening torque, refer to Tightening lug bolts 188
- Tilt function, passenger-side mirror 39
- "Time" 74
- "Time 1" for independent ventilation 95
- "Time 2" for independent ventilation 95
- Timer, refer to Preselecting switch-on time 95
- Tire pressure monitoring, refer to Flat Tire Monitor 80
- Tire Quality Grading 173
- Tires
- age 172
- changing 174
- condition 173
- damage 174
- flat 187
- inflation pressure 170
- pressure monitoring 80
- replacing 187
- run-flat 175
- size 172
- tread 173
- wear indicators 174
- Tone control 131
- Tone on locking/unlocking 28
- Tools, refer to Onboard tool kit 184
- "Top 8" for portable phone 155
- Torque 198
- lug bolts 188
- Touch tone dialing 156
- Tow fitting 193
- Towing
- with automatic transmission 193
- with sequential manual transmission SMG 193
- Towing eye 193
- Tow sockets for tow fitting 194
- Tracks
- random play sequence 142, 146
- sample scan 142, 145
- Track width, refer to Dimensions 199
- Traction Control System, refer to DSC 78
- Transmission
- automatic transmission with Steptronic 54
- manual transmission 51
- Sequential manual transmission SMG 51
- Transporting children safely 45
- Transport securing device, refer to Securing the load 109
- Tread depth, refer to Tire tread 173
- "Treble", audio systems 132
- "Trip computer" 72
- Trip computer 71
- Trip-distance counter, refer to Trip odometer 65
- "Triple turn signal activation" 56
- Trip odometer 65
- Trunk lid, refer to Luggage compartment lid 31
- Turning circle, refer to Dimensions 199
- Turn signal indicators 56
- replacing the bulbs 185
- Uniform Tire Quality Grading 173
- "Units" 74
- Units
- average fuel consumption 74
- temperature 74
- Universal garage-door opener, refer to Integrated universal remote control 96
- Universal remote control 96
- Unlock code 152
- Unlocking
- engine hood 177
- from inside 30
- from outside 27
- "Update services" 165
- V**
- Valve stem seal caps 188
- Vehicle
- battery 188
- care, refer to Caring for your vehicle brochure
- dimensions 199
- loading 108
- parking 50
- washing, refer to Caring for your vehicle brochure
- weights 200
- Vehicle jack 187
- Vehicle position 115
- "Vehicle settings" 38
- Ventilation 94
- draft-free 94
- front 94
- rear 94
- Ventilation while parked 94
- "Vent settings" 92
- Vents of the automatic climate control 90
- Voice command system 20
- Voice instructions for navigation system 124
- muting 125
- repeating 125
- switching on/off 124
- volume 125



Voice phone book [158](#)  
Volume [130](#)  
– audio sources [130](#)  
– portable phone [152](#)  
– speed-dependent [132](#)  
– voice instructions [125](#)  
Volume of the luggage compartment [200](#)

## W

Warning and indicator lamps [13](#)  
Warning messages, refer to Check Control [68](#)  
Warning triangle [191](#)  
Washer fluid [57](#)  
– content of the reservoir [58](#)  
– reservoir of the cleaning systems [58](#)  
Water on the road, floods [107](#)  
Waveband [134](#)  
"WB" [130](#), [137](#)  
Wear indicators in the tires [174](#)  
Weights [200](#)  
Wheelbase, refer to Dimensions [199](#)  
Wheel changes [187](#)  
Wheels and tires [170](#)  
"Where to go?" [164](#)  
Width, refer to Dimensions [199](#)  
Windows [33](#)  
– convenience opening [28](#)  
– convenience operation [29](#)  
– safety switch [34](#)  
Windshield washer system [57](#)  
– washer fluid [57](#)  
– washer nozzles [57](#)  
Windshield wipers [57](#)  
– blade replacement [184](#)  
Winter tires [175](#)  
– speed limit selection [72](#)  
– storage [175](#)  
Wiper blade replacement [184](#)  
Wiper system [57](#)

"With freeways" for navigation [121](#)  
Wordmatch principle for navigation [122](#)  
Working in the engine compartment [177](#)  
Wrenches/screwdrivers, refer to Onboard tool kit [184](#)

## X

Xenon lamps [185](#)  
– replacing the bulbs [185](#)

امداد خودرو فارما

تلفن شبانه روزی: ۰۲۱-۸۸۸۶۲۰۸۵

FarmaSOS.com

# امداد خودرو فارما

تلفن شبانه روزی: ۰۲۱-۸۸۸۶۲۰۸۵

**FarmaSOS.com**

## Refueling

To ensure that you always have all the essential data at hand when refueling, we recommend that you fill in the following tables with the specifications and information that apply to your vehicle. Consult the index for individual specifications.

### Fuel

Designation

Please enter your preferred fuel here.

### Engine oil

Quality

The oil quantity between the two marks on the dipstick is approx. 1.6 US quarts/ 1.5 liter.

## Tire inflation pressures

Summer tires  
Front

Rear

Winter tires  
Front

Rear

Up to 4 persons

5 persons or 4 plus luggage

تلفن شبانه روزی: ۰۸۵ ۸۸۶۲ ۰۸۱

FarmaSOS.com

More about BMW



bmwusa.com

The Ultimate  
Driving Machine

# امداد خودرو فارما

تلفن شبانه روزی: ۰۸۵-۸۸۸۶۲-۰۲۱

**FarmaSOS.com**