

Owner's Manual
for Vehicle



The Ultimate
Driving Machine



اراد خودرو فارما

تلفن شماره زوری: ۰۲۱-۸۸۸۶۲۰۸۵

FarmaSOS.com

امداد خودرو فارما

تلفن شبانه روزی: ۰۲۱-۸۸۸۶۲۰۸۵

FarmaSOS.com

528i Owner's Manual for Vehicle

535i Congratulations, and thank you for choosing a BMW.

550i Thorough familiarity with your vehicle will provide you with enhanced control and security when you drive it. We therefore have this request:

528i xDrive 535i xDrive

Please take the time to read this Owner's Manual and familiarize yourself with the information that we have compiled for you before starting off in your new vehicle. It contains important data and instructions intended to assist you in gaining maximum use and satisfaction from your BMW's unique range of technical features. The manual also contains information on maintenance designed to enhance operating safety and contribute to maintaining the value of your BMW throughout an extended service life.

This manual is supplemented by a Service and Warranty Information Booklet for US models or a Warranty and Service Guide Booklet for Canadian models.

We wish you an enjoyable driving experience.

BMW AG

امداد خودرو فارما

تلفن شبانه روزی: ۰۲۱-۸۸۸۶۲۰۸۵

FarmaSOS.com

امداد خودرو فارما

تلفن شبانه روزی: ۰۲۱-۸۸۸۶۲۰۸۵

FarmaSOS.com

Contents

The fastest way to find specific topics is to use the index, refer to page 270.

Using this Owner's Manual

- 4 Notes
- 7 Reporting safety defects

At a glance

- 10 Cockpit
- 16 iDrive
- 24 Voice command system

Controls

- 30 Opening and closing
- 47 Adjusting
- 58 Transporting children safely
- 62 Driving
- 79 Everything under control
- 90 Technology for comfort, convenience and safety
- 108 Lamps
- 114 Climate
- 121 Practical interior accessories

Driving tips

- 134 Things to remember when driving

Navigation

- 142 Starting navigation system
- 144 Destination entry
- 156 Destination guidance
- 165 What to do if ...

Entertainment

- 168 On/off and tone
- 172 Radio
- 179 Satellite radio
- 182 CD player and CD changer
- 188 AUX-IN connection
- 189 USB-audio interface/mobile phone audio interface

Communications

- 194 Telephoning
- 209 BMW Assist

Mobility

- 220 Refueling
- 222 Wheels and tires
- 232 Under the hood
- 237 Maintenance
- 239 Care
- 243 Replacing components
- 253 Giving and receiving assistance

Reference

- 260 Technical data
- 265 Short commands of voice command system
- 270 Everything from A to Z

ایران خودرو فارما

تلفن شبانه روزی: ۰۲۱ ۸۸۶۲۰۸۵

FarmaSOS.com

At a glance

Controls

Driving tips

Navigation

Entertainment

Communications

Mobility

Reference

Notes

Using this Owner's Manual

We have made every effort to ensure that you are able to find what you need in this Owner's Manual as quickly as possible. The fastest way to find specific topics is to refer to the detailed index at the back of the manual. If you wish to gain an initial overview of your vehicle, you will find this in the first chapter.

Should you sell your BMW some day, please remember to hand over the Owner's Manual as well; it is an important component of your vehicle.

Additional sources of information

Should you have any other questions, your BMW center will be happy to advise you.

You can find information on BMW, e.g. on technology, on the Internet at www.bmwusa.com.

Symbols used



Indicates precautions that must be followed precisely in order to avoid the possibility of personal injury and serious damage to the vehicle. ◀



Indicates information that will assist you in gaining the optimum benefit from your vehicle and enable you to care more effectively for your vehicle. ◀



Refers to measures that can be taken to help protect the environment. ◀

◀ Marks the end of a specific item of information.

* Indicates special equipment, country-specific equipment and optional accessories, as well as equipment and functions not yet available at the time of printing.

"..." Identifies Control Display texts used to select individual functions.

🗣️ These sections contain information on using the voice activation system.

>...< Verbal instructions to use with the voice activation system.

>>...<< Identifies the answers generated by the voice activation system.

Symbols on vehicle components



Indicates that you should consult the relevant section of this Owner's Manual for information on a particular part or assembly.

The individual vehicle

When purchasing your BMW, you have decided in favor of a model with individualized equipment and features. This Owner's Manual describes the entire array of options and equipment available with a specific BMW model.

Please bear in mind that the manual may contain information on accessories and equipment that you have not specified for your own vehicle. Sections describing options and special equipment are marked by asterisks * to assist you in identifying possible differences between the descriptions in this manual and your own vehicle's equipment.

If equipment in your BMW is not described in this Owner's Manual, please refer to the accompanying Supplementary Owner's Manuals.

Editorial notice

BMW pursues a policy of continuous, ongoing development that is conceived to ensure that our vehicles continue to embody the highest quality and safety standards combined with advanced, state-of-the-art technology. For this reason, it is possible that the features described in this Owner's Manual could differ from those on your vehicle.

For your own safety

Maintenance and repairs



Advanced technology, e.g. the use of modern materials and high-performance electronics, requires specially adapted maintenance and repair methods. Therefore, have corresponding work on your BMW performed only by your BMW center or a workshop that works according to BMW repair procedures with correspondingly trained personnel. If this work is not carried out properly, there is a danger of subsequent damage and related safety hazards. ◀

امداد خودرو فارما
تلفن شبانه روزی: ۰۸۵
FarmaSOS.com

Parts and accessories

 For your own safety, use genuine parts and accessories approved by BMW.

When you purchase accessories tested and approved by BMW and Genuine BMW Parts, you simultaneously acquire the assurance that they have been thoroughly tested by BMW to ensure optimum performance when installed on your vehicle.

BMW warrants these parts to be free from defects in material and workmanship. BMW will not accept any liability for damage resulting from installation of parts and accessories not approved by BMW.

BMW cannot test every product made by other manufacturers to verify if it can be used on a BMW safely and without risk to either the vehicle, its operation or its occupants.

Genuine BMW Parts, BMW Accessories and other products approved by BMW, together with professional advice on using these items, are available from all BMW centers.

Installation and operation of non-BMW approved accessories such as alarms, radios, amplifiers, radar detectors, wheels, suspension components, brake dust shields, telephones, including operation of any mobile phone from within the vehicle without using an externally mounted antenna, or transceiver equipment such as CBs, walkie-talkies, ham radios or the like may cause extensive damage to the vehicle, compromise its safety, interfere with the vehicle's electrical system, or affect the validity of the BMW Limited Warranty. See your BMW center for additional information. ◀

 Maintenance, replacement, or repair of the emission control devices and systems may be performed by any automotive repair establishment or individual using any certified automotive part. ◀

California Proposition 65 Warning

California law requires us to issue the following warning:

 Engine exhaust and a wide variety of automobile components and parts, including components found in the interior furnishings in a vehicle, contain or emit chemicals known to the State of California to cause cancer and birth defects and reproductive harm. In addition, certain fluids contained in vehicles and certain products of component wear contain or emit chemicals known to the State of California to cause cancer and birth defects or other reproductive harm.

Battery posts, terminals and related accessories contain lead and lead compounds. Wash your hands after handling.

Used engine oil contains chemicals that have caused cancer in laboratory animals. Always protect your skin by washing thoroughly with soap and water. ◀

Service and warranty

We recommend that you read this publication thoroughly.

Your BMW is covered by the following warranties:

- ▷ New Vehicle Limited Warranty
- ▷ Rust Perforation Limited Warranty
- ▷ Federal Emissions System Defect Warranty
- ▷ Federal Emissions Performance Warranty
- ▷ California Emission Control System Limited Warranty

Detailed information about these warranties is listed in the Service and Warranty Information Booklet for US models or in the Warranty and Service Guide Booklet for Canadian models.

Reporting safety defects

For US customers

The following applies only to vehicles owned and operated in the US.

If you believe that your vehicle has a defect which could cause a crash or could cause injury or death, you should immediately inform the National Highway Traffic Safety Administration, NHTSA, in addition to notifying BMW of North America, LLC, P.O. Box 1227, Westwood, New Jersey 07675-1227, Telephone 1-800-831-1117.

If NHTSA receives similar complaints, it may open an investigation, and if it finds that a safety defect exists in a group of vehicles, it may order a recall and remedy campaign. However, NHTSA cannot become involved in individual problems between you, your dealer, or BMW of North America, LLC.

To contact NHTSA, you may call the Vehicle Safety Hotline toll-free at 1-888-327-4236 (TTY: 1-800-424-9153); go to <http://www.safercar.gov>; or write to: Administrator, NHTSA, 400 Seventh Street, SW., Washington, DC 20590. You can also obtain other information about motor vehicle safety from <http://www.safercar.gov>

For Canadian customers

Canadian customers who wish to report a safety-related defect to Transport Canada, Defect Investigations and Recalls, may call 1-800-333-0510 toll-free from anywhere in Canada or 1-613-993-9851 from the Ottawa region and from other countries, or contact Transport Canada by mail at: Transport Canada, ASFAD, Place de Ville, Tower C, 330 Sparks Street, Ottawa, ON, K1A 0N5.

You can also obtain other information about motor vehicle safety from <http://www.tc.gc.ca>



امداد خودرو فارما

تلفن شبانه روزی: ۰۲۱-۸۸۸۶۲۰۸۵

FarmaSOS.com

At a glance

This overview of buttons, switches and displays is intended to familiarize you with your vehicle's operating environment.

The section will also assist you in becoming acquainted with the control concepts and options available for operating the various systems.





تلفن شبانه روزی: ۰۲۱-۸۸۸۶۲۰۸۵

FarmaSOS.com

Cockpit

Around the steering wheel: controls and displays



- | | | |
|-------|--|-------------------------|
| 1 | Rear side window safety switch | 43 |
| 2 | Sedan: sun blind* for rear window | 122 |
| 3 | Opening and closing windows | 42 |
| 4 | Adjusting exterior mirrors | 54 |
| | Automatic curb monitor* | 55 |
| 5 | Folding exterior mirrors in and out* | 55 |
| 6 |  Turn signals
 High beams, headlamp flasher
 High-beam assistant*
 Roadside parking lamps | 68
110
110
110 |
| CHECK | Check Control | 84 |
| BC | Computer | 80 |

7 Buttons on the steering wheel



Mobile phone* 194:

- ▷ Press: accepting and ending call, starting dialing* for selected phone number and redialing if no phone number is selected
- ▷ Press and hold: redialing



Volume



Activating/deactivating voice command system* 24



Changing radio station 172

Selecting music track 183



Scrolling in phone book and in lists with stored phone numbers



Individually programmable* 56



Individually programmable* 56



Leaving lane warning* 106

8 Instrument cluster 12

9



Windshield wipers 69



Rain sensor 69



Sports Wagon: rear window wiper 70

10



Starting/stopping engine and switching ignition on/off 62

11 Ignition lock 62

12 Horn, entire surface

13



Steering wheel heater* 56



Steering wheel adjustment 56

14



Cruise control* 70



Active cruise control 71

15 Releasing hood 232

16



Opening luggage compartment lid/tailgate 36, 37

17



Head-Up Display* 102



BMW Night Vision* 104

18



Parking lamp 108



Daytime running lamps* 109



Low beams 108



Welcome lamps 108



Automatic headlamp control* 108



Daytime running lamps* 109



Welcome lamps 108



Adaptive Head Light* 110



High-beam assistant* 110

19



Instrument lighting 112



Fog lamps* 112

Instrument cluster



- 1 Indicator lamps for turn signals
- 2 Speedometer
- 3 Indicator and warning lamps 13
- 4 Displays for
 - ▷ Active cruise control* 75
 - ▷ Leaving lane warning* 106
- 5 Tachometer 79
- 6 Energy Control 80
- 7 Display for
 - ▷ Clock/date 79
 - ▷ Outside temperature 79
 - ▷ Indicator and warning lamps 84
 - ▷ Speed of cruise control* 71
 - ▷ Desired speed for active cruise control* 75
- 8 Display for
 - ▷ Odometer and trip odometer 79
 - ▷ Computer 80
 - ▷ Date and remaining travel distance for service requirements 82
 - ▷ Automatic transmission with Steptronic* 64
 - ▷ Sport automatic transmission* 67
 - ▷ HDC Hill Descent Control* 93 93
 - ▷ High-beam assistant* 110
 - ▷ ▲ Check Control message present 84
- 9 Fuel gauge 80
- 10 Resetting trip odometer 79

Indicator and warning lamps

The concept



The indicator and warning lamps can light up in different combinations and colors.

Some lamps are tested for proper function by briefly lighting up during starting of the engine or when the ignition is switched on.

Explanatory text messages



Text messages at the lower edge of the Control Display explain the meaning of the displayed indicator and warning lamps.

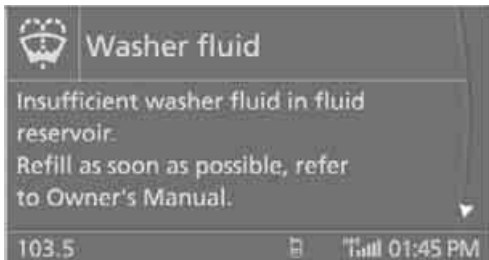







Additional information, e.g. on the cause and elimination of a malfunction, can be opened via the Check Control system, refer to page 84.

In urgent cases, this information will be shown as soon as the corresponding lamp comes on.









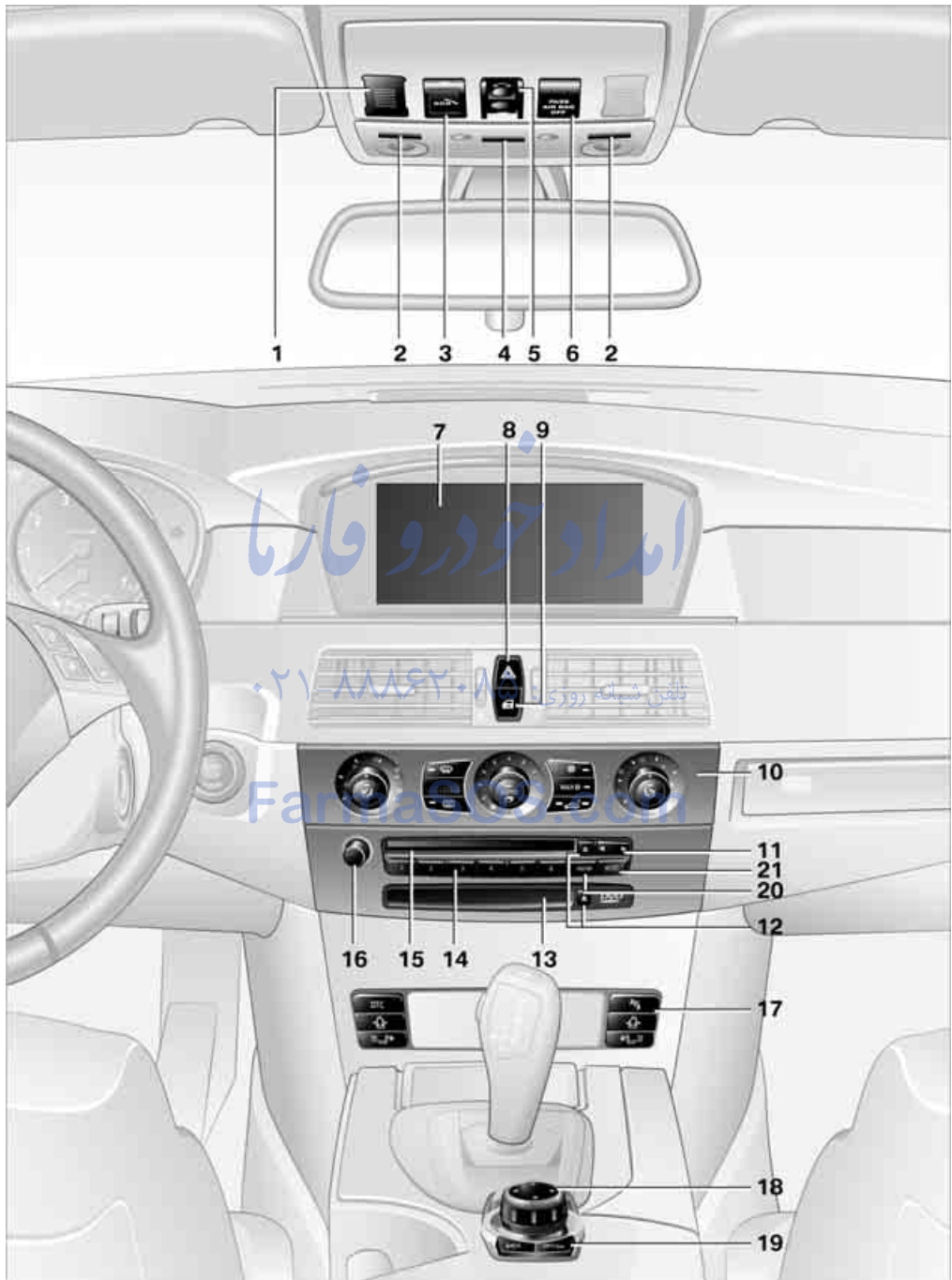



Indicator lamps without text messages

The following indicator lamps signal particular functions:

-  High beams/headlamp flasher 110
-  Fog lamps* 112
-  Handbrake applied 64
-  Handbrake applied for Canadian models
-  Lamp flashes:
DSC or DTC controls the drive and braking forces for maintaining vehicle stability 92
-  DTC Dynamic Traction Control 92
-  Exhaust-gas values 238

Around the center console: controls and displays



- 1 Microphone for hands-free mode for telephone* and for voice command system* 24
- 2 Reading lamps 113
- 3 SOS: initiating an emergency request 253
- 4 Interior lamps 112
- 5 Glass sunroof*, electric 43
Panorama glass sunroof 45
- 6 Passenger airbag status lamp 101
- 7 Control Display 16
Displays for menu navigation
- 8 Hazard warning flashers
- 9 Central locking system 35
- 10 Automatic climate control 114
- TEMP Temperature setting, left/right 115
- AUTO Automatic air distribution and volume 115
-  Cooling function 117
-  AUC Automatic recirculated-air control 117
-  Recirculated-air mode 117
-  Maximum cooling 117
-  Air volume 116
-  Defrosting windows and removing condensation 116
-  Rear window defroster 116
- 11 Changing
 - ▷ radio station 172
 - ▷ track 168
- 12 Ejecting
 - ▷ navigation DVD* 142
 - ▷ audio CD 182
- 13 Programmable memory buttons 22
- 14 Drive for navigation DVDs* 142
- 15 Drive for audio CDs 182
- 16 Switching Entertainment sound output on/off and adjusting volume 168
- 17  Heated seats* 53
-  Active seat ventilation* 54
-  Adjusting active backrest width* 49
-  Active seat* 54
-  PDC Park Distance Control* 90
- DTC DTC Dynamic Traction Control 92
-  Opening luggage compartment lid/tailgate* 36, 37
- 18 Controller 16
Can be turned, pressed, or moved in four directions
- 19 Opening start menu on Control Display 17
- 20 Selecting AM or FM waveband
- 21 Selecting radio, CD and CD changer

iDrive combines the functions of a large number of switches. This allows these functions to be operated from a central position. The following section provides an introduction to basic menu

navigation. The control of the individual functions is described in connection with the relevant equipment.

Controls

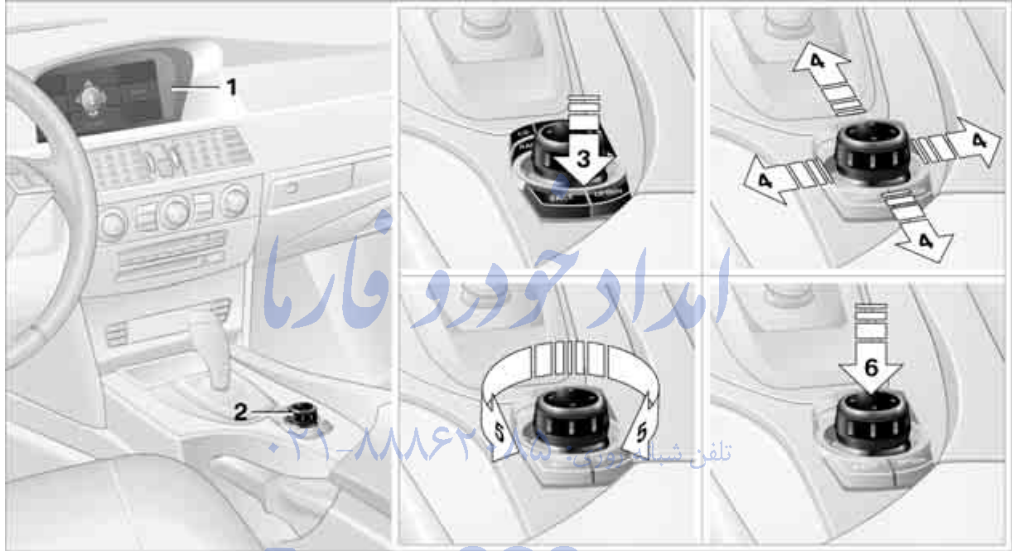

1 Control Display

2 Controller with buttons

You can use the buttons to open the menus directly. The controller can be used to select the menu items and create settings.

- ▷ Call up a menu directly, arrow **3**
- ▷ Move in four directions, arrows **4**
- ▷ Turn, arrow **5**
- ▷ Press, arrow **6**

! To avoid posing an unnecessary hazard due to inattention, both to your own vehicle's occupants and to other road users: never attempt to use the controls or make entries unless traffic and road conditions allow. ◀

Buttons on the controller	Function
MENU	Opens the main menu
RADIO	Opens the Radio menu
CD	Opens the last Entertainment menu, e.g. CD or AUX
NAV	Opens the Navigation menu From the Navigation menu: opens the main menu
TEL	Opens the Telephone menu
BACK	Opens the previous menu Not possible from the main menu
OPTION	Opens the Options menu

امداد خودرو فارما

تلفن شبانه روزی: ۰۲۱-۸۸۸۶۲۰۸۵

FarmaSOS.com

Menu overview

Communication

- ▷ Telephone*
- ▷ BMW Assist* or BMW TeleServices*

Navigation or onboard information

- ▷ Navigation system*
- ▷ Onboard information, e.g. for displaying the average fuel consumption

Entertainment

- ▷ Radio
- ▷ CD player and CD changer*
- ▷ AUX-IN connection
- ▷ USB-audio interface* for external audio device

Climate

- ▷ Vent settings
- ▷ Automatic programs
- ▷ Seat heater distribution*
- ▷ Parked car operation*

i menu

- ▷ Switching off Control Display
- ▷ Tone and display settings
- ▷ Settings for your vehicle, e.g. for the central locking system
- ▷ Display of maintenance intervals and deadlines for legally mandated inspections
- ▷ Settings for telephone

Operating principle

From radio readiness, refer to page 62, the following message is shown on the Control Display:

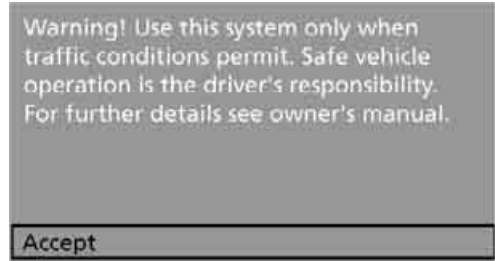

To hide the message:

Press the controller.

This displays the start menu.

The message is hidden after approx. 10 seconds.

Start menu



You can open all of the iDrive functions using five menu items.

Opening start menu

Press the **MENU** button.

Opening menu items of the start menu

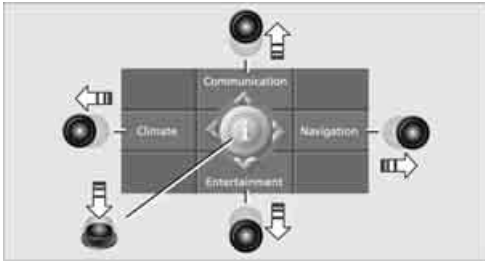

In the start menu, you can open the Communication, Navigation, Entertainment and Climate menu items by moving the controller to the left, right, front or rear.

You can open the **i** menu by pressing the controller.

Comfort opening of menu items

Comfort opening offers you:

- ▶ Opening of a menu item of the start menu in the last display shown
- ▶ Direct changing between Communication, Navigation, Entertainment and Climate without pressing the **MENU** button

To do so, move the controller in the corresponding direction and hold it there for longer than 2 seconds or use the buttons on the controller.

Displays in menu

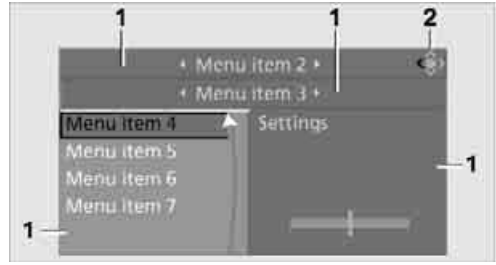

- 1 Each menu is divided into fields. The respective active field is highlighted.
- 2 A symbol indicates the last selected menu item of the start menu:



Communication



Navigation or onboard information



Entertainment



Climate



i menu

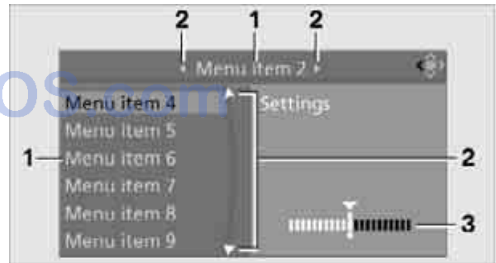

- 1 Menu items are usually grouped in horizontal or vertical lists.
- 2 In these lists, arrows indicate the possibility of accessing other menu items that are not currently visible.
- 3 Settings are displayed graphically or numerically.

Operating principle at a glance

Basic operation via iDrive is described in this view.

You can view the individual steps under Settings on Control Display, Setting time, refer to page 87.

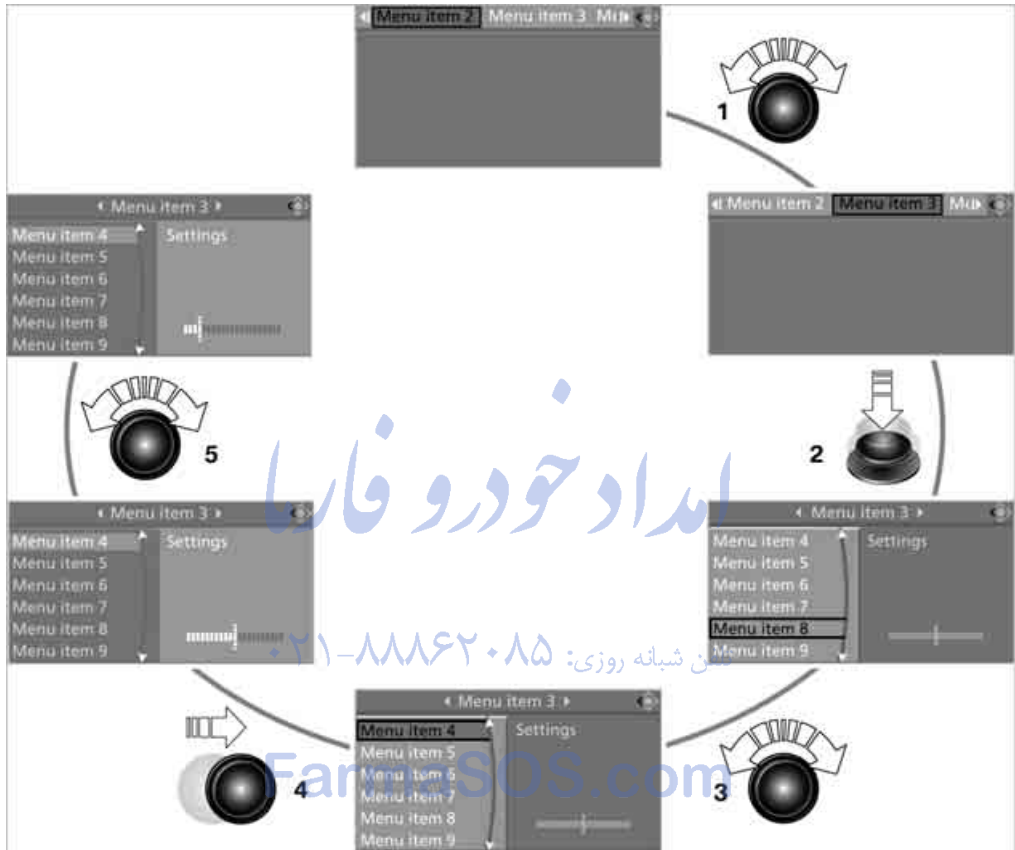

- 1 Selecting menu item:**
 - ▷ Turn the controller; the highlight moves
 - ▷ Menu items shown in white can be selected by highlighting
- 2 Activating menu item:**
 - ▷ Press the controller
 - ▷ New menu items are displayed or the function is carried out
- 3 Selecting menu item: refer to 1**
- 4 Changing between fields:**
 - ▷ Briefly move the controller to the left, right, front or back
 - ▷ Release controller
 - ▷ Active field appears lighter
- 5 Adjusting settings:**
 - ▷ Turn controller
 - ▷ Graphic display, numerical value or text displays can be changed
 - ▷ Confirmation by changing field

Status information

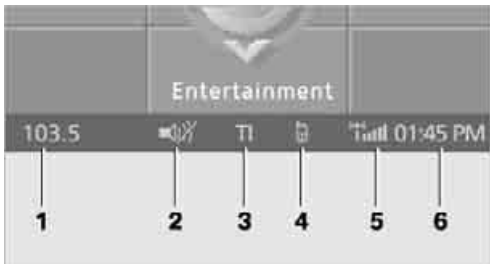

- 1 Display for:
 - ▶ Entertainment:
Radio, CD, AUX, USB-audio interface*
 - ▶ Telephone* in "Communication":
Name of linked mobile phone, network search or no network
 - ▶ "BMW Assist"*:
Active voice connection with a BMW Assist service
- 2 Entertainment sound output off
- 3 Station that transmits traffic information is received*:
"TI":
Reception of traffic information for the navigation system is possible and activated
- 4 Display for:
 - ▶ New entries present in "Missed calls"*
 - ▶ Roaming active
- 5 Telephoning* is possible if the mobile phone is paired in the vehicle
 Reception strength of mobile phone network, dependent on mobile phone
- 6 Time

Other displays:

The status information is temporarily hidden when there are Check Control instructions or inputs via the voice command system*.

Assistance window*



Additional information appears in the assistance window:

- ▶ The computer or trip computer*
- ▶ The arrow or map view with a navigation system*
- ▶ The current location

Selecting display

1. Move the controller to the right to change to the assistance window and press the controller.

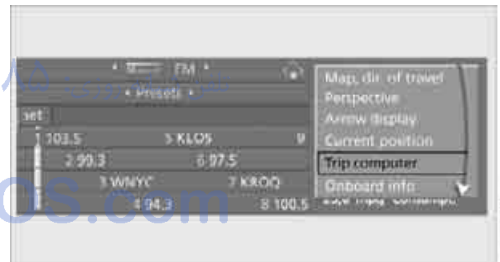

2. Select a menu item.
3. Press the controller.

Switching assistance window off/on

1. Move the controller to the right to change to the assistance window and press the controller.
2. Select "Assist. window off" and press the controller.



To switch on, change to the assistance window and press the controller.

Switching Control Display off/on

1. Press the **MENU** button.
This opens the start menu.
2. Press the controller to open the **i** menu.
3. Select "Display off" and press the controller.



To switch on, press the controller.

Programmable memory buttons

You can save and request certain functions of iDrive on the programmable memory buttons:

- ▷ Destinations of navigation

- ▷ Telephone, phone numbers
- ▷ Entertainment:
 - ▷ radio station
 - ▷ CD
 - ▷ CD compartment of CD changer*
 - ▷ AUX
 - ▷ USB-audio interface*

The assignment of the programmable buttons is stored for the remote control currently in use.

Saving function

Destinations of navigation

1. Select navigation destination, e.g. in the destination list or the address book.
2. Press the **1** ... **6** button longer than 2 seconds.

Special features:

- ▷ With the destination guidance system and the map view started, the current destination is stored.
- ▷ During destination entry via a map, the coordinates at the cursor are stored, not the current destination.

Telephone, phone numbers

1. Enter the phone number or select it in a list of the stored phone numbers, e.g. of the A-Z list.
2. Press the **1** ... **6** button longer than 2 seconds.

If a name is assigned to the phone number, the name will also be stored.

Entertainment

In the Entertainment menu, the sound source currently heard, e.g. a radio station, is stored, regardless of the selection on the Control Display.

1. Select the desired function, e.g. radio station or CD.
2. Press the **1** ... **6** button longer than 2 seconds.

 If the vehicle is equipped with two drives, the current track is stored for CDs with compressed audio files. ◀

Running function

Press the  ...  button.

When selecting a phone number, the connection is also established, or the destination guidance is started when a navigation destination is selected.

Displaying button assignment





You can display the assignment of the buttons by touching them with your finger. Please do not wear gloves when doing so. Touching with an object, e.g. a pen, does not function.

Displaying short info

Touch the  ...  button.

The assignment of the buttons is displayed.



-  Destination of navigation system
-  Entertainment source
-  Telephone, phone number
-  Not assigned

Displaying detailed information

Touch the  ...  button longer.

Deleting button assignments

1. Press the **MENU** button.
This opens the start menu.
2. Press the controller to open the **i** menu.
3. Select "Settings" and press the controller.
4. Select "Vehicle / Tires" and press the controller.

5. Select "Programmable Memory Keys" and press the controller.

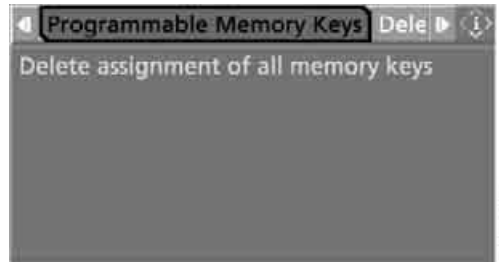

6. Select "Delete assignment of all memory keys" and press the controller.
7. Confirm with "Yes".

Voice command system*

The concept

The voice command system allows you to control operation of various vehicle systems without taking your hands off the steering wheel.

Individual menu items on the Control Display can be spoken as commands. This frees you of having to use the controller.



The voice command system transforms your oral commands into control signals for the selected systems and provides support in the form of instructions or questions.

The voice command system uses a special microphone located in the area of the interior rearview mirror, refer to page 14.

Precondition

Via iDrive, set the language that applies for the voice command system in order to enable identification of the spoken commands. To set the language of iDrive, refer to page 89.

Symbols in Owner's Manual

-  ›...‹ Say the specified commands word for word.
-  ›...‹‹ Indicates responses of the voice command system.

Voice commands

Activating voice command system

1. Press the  button.



 This symbol on the Control Display and an acoustic signal tell you that the voice command system can respond to commands.



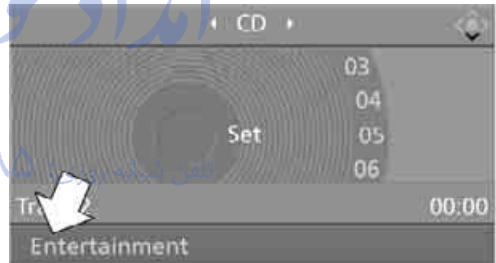

2. Say the command.
The command is displayed on the Control Display.



 This symbol is shown on the Control Display when you can input additional commands. If no other commands are possible, then operate the equipment via iDrive.

Terminating or canceling voice command system

Press the  button on the steering wheel or

-  ›Cancel‹

Commands

Having possible commands read aloud

You can have the system read aloud the possible commands related to the selected menu item on the Control Display.

To have the system list the possible commands:

 ›Options‹

For instance, if you have selected "CD", the commands available for operating the CD player and CD changer* are read out.

Opening help

 ›Help‹

Using alternative commands

There are often a number of commands to run a function, e.g.:

 ›Radio on‹ or ›Turn radio on‹



Running functions directly with short commands

With short commands you can run certain functions directly, regardless of which menu item is selected, refer to page 265.

Opening start menu

 ›Main menu‹



Example: selecting a track

1. Switch on Entertainment sound output if necessary.
2. Press the  button on the steering wheel.
3.  ›Entertainment‹
The system says:
››Entertainment‹‹

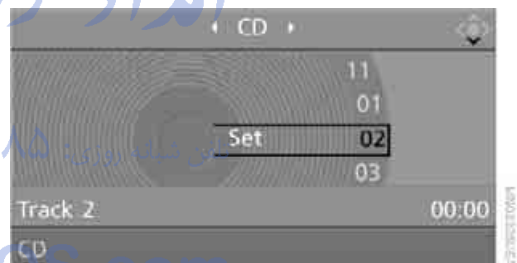

4.  ›CD‹
The system says:
››CD on‹‹



5. Press the  button on the steering wheel.
6.  Select track, e.g.:
›Track 1‹
The system says:
››Track 1‹‹



Notes

 The mobile phone can also be operated with voice commands, refer to page 205. ◀

For voice commands, bear the following in mind:

- ▷ Say the commands and numbers smoothly and at normal volume, avoiding excessive emphasis and pauses. This also applies to spelling when entering the destination.
- ▷ Always issue commands in the language of the voice command system.
- ▷ When selecting a radio station, use the common pronunciation of the station name.
- ▷ For entries in the voice-activated phone book, only use names in the language of the voice command system and do not use abbreviations.
- ▷ Keep the doors, windows and glass sunroof* or panorama glass sunroof* closed to prevent interference from ambient noise.
- ▷ Avoid making other noise in the vehicle while speaking.

تلفن شبانه روزی: ۰۸۵-۸۸۶۲۰۲۱

FarmaSOS.com

امداد خودرو فارما

تلفن شبانه روزی: ۰۲۱-۸۸۸۶۲۰۸۵

FarmaSOS.com



امداد خودرو فارما

تلفن شبانه روزی: ۰۲۱-۸۸۸۶۲۰۸۵

FarmaSOS.com

Controls

This chapter is intended to provide you with information for complete control of your vehicle. Its extensive array of features and accessories, both for driving and for your own safety, comfort and convenience, are described here.

تلفن شبانه روزی: ۰۲۱-۸۸۸۶۲۰۸۵

FarmaSOS.com

Opening and closing

Keys/remote control



- 1 Remote control with integrated key
- 2 Spare key
- 3 Adapter for spare key, in glove compartment

Remote control with integrated key

Each remote control contains a battery which is charged in the ignition lock while driving. Drive a longer distance with each remote control at least twice a year to keep the battery charged. In cars with convenient access*, the remote control contains a replaceable battery, refer to page 42.

Depending on which remote control is detected by the vehicle during unlocking, different settings are activated and executed in the vehicle, refer to Personal Profile, page 31.

Information on the required for maintenance is also stored in the remote control, refer to Service data in remote control, page 237.

Integrated key



Press button 1 to unlock the key.

The integrated key fits the following locks:

- ▷ Glove compartment, refer to page 123
- ▷ Sports Wagon: floor panel flap in cargo bay, refer to page 129
- ▷ Driver's door, refer to page 34
- ▷ Luggage compartment lid, refer to page 36.

New remote controls

To obtain additional or replace lost keys, new remote controls with an integrated key are available at your BMW center.

Spare key

Store the spare key in a safe place such as your wallet. This key is not intended for regular use.

The spare key and integrated key fit the same locks.

Adapter for spare key

The adapter is required so that the vehicle can be started with the spare key or radio readiness can be switched on.



Remove the adapter from the holder in the glove compartment and slide the spare key into the adapter before use.

Personal Profile

The concept

You can set a number of functions of your BMW individually according to your preferences. Personal Profile ensures that most of these settings are stored for the remote control currently in use without you having to do anything. When the vehicle is unlocked, the corresponding remote control is detected and the settings stored for it are called up and carried out.

This means that you will always find your BMW set to your own personal settings even if another person with his/her own remote control and settings has used the vehicle since the last time you drove it. The individual settings are stored for a maximum of four remote controls, for two with comfort access*.

Personal Profile settings

Details on the settings are provided on the specified pages.

- ▷ Behavior of the central locking system when unlocking vehicle, refer to page [32](#)
- ▷ Automatic locking of the vehicle, refer to page [35](#)
- ▷ Programming buttons* on steering wheel, refer to page [56](#)

- ▷ Displays on Control Display:
 - ▷ Brightness of the Control Display, refer to page [88](#)
 - ▷ Measuring units for consumption, route/distances, temperature, and pressure, refer to page [89](#)
 - ▷ 12h/24h clock format, refer to page [88](#)
 - ▷ Date format, refer to page [88](#)
 - ▷ Language on Control Display, refer to page [89](#)
- ▷ Lighting settings:
 - ▷ Triple turn signal activation, refer to page [68](#)
 - ▷ Welcome lamps, refer to page [108](#)
 - ▷ Pathway lighting, refer to page [109](#)
 - ▷ Daytime running lamps*, refer to page [109](#)
 - ▷ High-beam assistant*, refer to page [110](#)
- ▷ PDC Park Distance Control*: optical warning, refer to page [90](#)
- ▷ Head-Up Display*: selection and brightness of display, refer to page [102](#)
- ▷ BMW Night Vision*: display settings, refer to page [105](#)
- ▷ Automatic climate control: AUTO program and intensity, cooling function, and automatic recirculated air control/recirculated air mode, temperature, air distribution, temperature in the upper body region, refer to text starting on page [115](#)
- ▷ Navigation system*: voice instructions for destination guidance, refer to page [159](#)

In addition, the following, most recently selected settings are recalled during unlocking:

- ▷ Programmable memory buttons: selecting stored functions, refer to page [22](#)
- ▷ Positions of driver's seat, outside mirrors, and steering wheel*, refer to page [49](#)
- ▷ Audio sources: volume and tone settings, refer to page [169](#)

- ▷ Radio:
 - ▷ Display of stored stations, refer to page 172
 - ▷ Switching RDS Radio Data System on/off*, refer to page 175
- ▷ Phone: volume setting, refer to page 200

Central locking system

The concept

The central locking system functions when the driver's door is closed.

The system simultaneously engages and releases the locks on the following:

- ▷ Doors
- ▷ Luggage compartment lid or tailgate and rear window
- ▷ Fuel filler door

Operating from outside

- ▷ Via the remote control
- ▷ Using door lock
- ▷ With comfort access* via the door handles

In addition, if the remote control is used, the welcome lamps, the interior lamps and the courtesy lamps* are switched on or off. The alarm system is armed/disarmed at the same time.

You can find more detailed information on the alarm system on page 39.

Operating from inside

Via the button for central locking, refer to page 35. The fuel filler door is not locked.

In the event of a sufficiently severe accident, the central locking system unlocks automatically. In addition, the hazard warning flashers and interior lamps come on.

Opening and closing: Using remote control

 Persons or animals left unattended in a parked vehicle can lock the doors from the inside. Always take along the remote control when leaving the vehicle so that the vehicle can then be opened from the outside. ◀

Unlocking

Press the  button.

The interior lamps, the courtesy lamps*, and the welcome lamps are switched on.

Setting unlocking behavior

You can set whether the first press of the button unlocks only the driver's door or the entire vehicle.

iDrive, for operating principle refer to page 16.

1. Press the **MENU** button. This opens the start menu.
2. Press the controller to open the **i** menu.
3. Select "Settings" and press the controller.
4. Select "Vehicle / Tires" and press the controller.
5. Change to upper field if necessary. Turn the controller until "Door locks" is selected and press the controller.

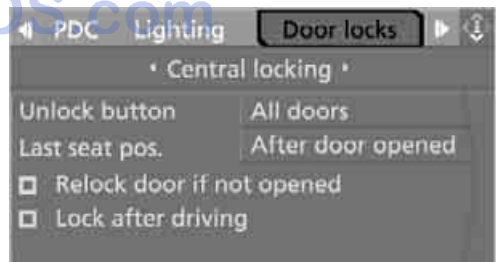

6. Select "Central locking" and press the controller.
7. Select "Unlock button" and press the controller.

8. Select a menu item:

▷ "All doors"

Pressing the  button once unlocks the entire vehicle.

▷ "Driver's door only"

Pressing the  button once unlocks the driver's door and the fuel filler door. Pressing the button twice unlocks the entire vehicle.



9. Press the controller.

The setting is stored for the remote control currently in use.

Comfort opening

Press and hold the  button. The windows and the glass sunroof* open.

Locking

Press the  LOCK button.

 Do not lock the vehicle from the outside if persons are inside, as unlocking from the inside is not possible without special knowledge. ◀

Switching on interior lamps

With vehicle locked:

Press the  LOCK button.

You can also use this function to locate your vehicle in parking garages etc.

Panic mode*

You can trigger the alarm system in case of danger:

Press the  button for at least 3 seconds.

Switching off alarm: press any button.

Sedan: opening luggage compartment lid

Press the  button for approx. 1 second.

The luggage compartment lid opens, regardless of whether it was previously locked or unlocked.

 During opening, the luggage compartment lid pivots back and up. Make sure that adequate clearance is available before opening.

To prevent accidentally locking yourself out, never lay the remote control in the cargo bay. A previously locked luggage compartment lid is also locked again after closing. ◀

Sports Wagon: unlocking tailgate

Press the  button for approx. 1 second.

The tailgate will open slightly, regardless of whether it was previously locked or unlocked.

 During opening, the tailgate pivots back and up. Make sure that adequate clearance is available before opening.

To prevent accidentally locking yourself out, never lay the remote control in the cargo bay. A previously locked tailgate is also locked again after closing. تلفن شیباء ۰۲۱-۸۸۶۲۰۸۸

When opening the tailgate, the roll-up cover is raised. ◀

 If pointed or sharp-edged objects could strike the rear window while driving, be sure to provide protection around all edges. Failure to do so could result in damage to the heating conductors of the rear window. ◀

Confirmation signals

You can activate or deactivate the confirmation signals.

1. Open the start menu.
2. Press the controller to open the  menu.
3. Select "Settings" and press the controller.
4. Select "Vehicle / Tires" and press the controller.
5. Change to upper field if necessary. Turn the controller until "Door locks" is selected and press the controller.

- Select "Confirmation" and press the controller.



- Select the desired signal.
- Press the controller.
 - The signal is activated.

Malfunction

The remote control may malfunction due to local radio waves. Should the remote control fail to operate due to interference of this kind, unlock and lock the vehicle via the door lock using a key.

If it is no longer possible to lock the vehicle using the remote control, then the battery is discharged. Use this remote control during an extended drive; this will recharge the battery, refer to page 30.

For US owners only

The transmitter and receiver units comply with part 15 of the FCC/Federal Communication Commission regulations. Operation is governed by the following:

FCC ID:
LX8766S
LX8766E
LX8CAS
LX8CAS2

Compliance statement:
This device complies with part 15 of the FCC Rules. Operation is subject to the following two conditions:

- This device must not cause harmful interference, and

- this device must accept any interference received, including interference that may cause undesired operation.

Any unauthorized modifications or changes to these devices could void the user's authority to operate this equipment. ◀

Opening and closing: Using door lock

Do not lock the vehicle from the outside if persons are inside, as unlocking from the inside is not possible without special knowledge. ◀

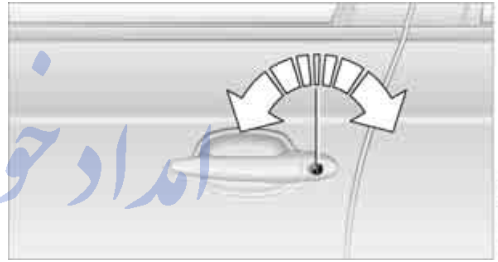

When unlocking

- Turning the key once unlocks the driver's door and the fuel filler door.
- Turning the key a second time unlocks the remaining doors and the luggage compartment lid/tailgate.

Convenient operation

You also have the option of operating the windows and the glass sunroof* from the driver's door lock.

Turn and hold the key in the positions for unlocking or locking.

Watch during the closing process to be sure that no one is injured. Releasing the key stops the operation. ◀

Manual operation

In the event of an electrical malfunction, you can turn a key all the way to the right or left in the door lock to lock or unlock the driver's door.

Opening and closing: from inside

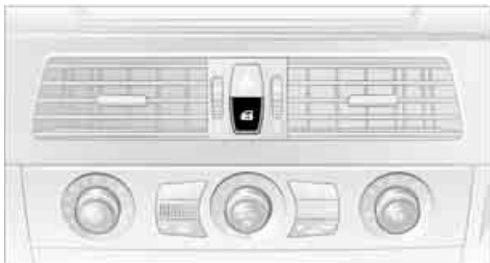

This button serves to unlock or lock doors and the luggage compartment lid or tailgate and rear window with the front doors closed, but does not activate the anti-theft system. The fuel filler door remains unlocked.

Automatic locking

iDrive, for operating principle refer to page 16.

1. Press the **MENU** button.
This opens the start menu.
2. Press the controller to open the **i** menu.
3. Select "Settings" and press the controller.
4. Select "Vehicle / Tires" and press the controller.
5. Change to upper field if necessary. Turn the controller until "Door locks" is selected and press the controller.
6. Select "Central locking" and press the controller.



7. Select a menu item:
 - ▷ "Relock door if not opened"
The central locking system locks again

after a short time if no door has been opened.

- ▷ "Lock after driving"
The central locking system locks the vehicle as soon as you start to drive.

8. Press the controller.
 The setting is selected.

The setting is stored for the remote control currently in use.

Unlocking and opening

- ▷ Either unlock the doors together with the button for the central locking system and then pull the door handle above the armrest or
- ▷ pull on the door handle of each door twice: the first time unlocks the door, the second time opens it.

Locking

- ▷ Use the central locking button to lock all of the doors simultaneously, or
- ▷ press down the lock button of a door.
To prevent you from being locked out, the open driver's door cannot be locked using the lock button.

 Persons or animals left unattended in a parked vehicle can lock the doors from the inside. Always take along the remote control when leaving the vehicle so that the vehicle can then be opened from the outside. ◀

Doors

Automatic soft closing*

To close the doors, merely push them gently. The closing process will then be carried out automatically.

 Make sure that the closing path of the doors is clear; otherwise injuries may result. ◀

Luggage compartment lid/tailgate

▶ During opening, the luggage compartment lid/tailgate pivots back and up. Make sure that adequate clearance is available before opening. ◀

▶ **Sedan**

Opening from inside



Press button **1** or button **2***: the luggage compartment lid opens unless it has been locked.

Opening from outside

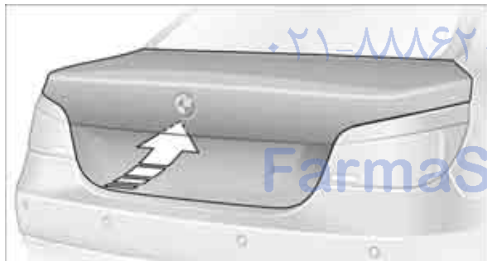

Press the button on the luggage compartment lid or the  button on the remote control for approx. 1 second: the luggage compartment lid opens.

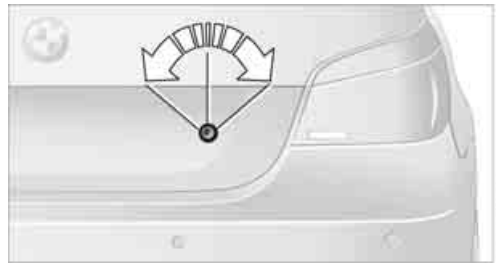

All keys, refer to page **30**, fit the luggage-compartment lid lock.

Locking separately

Turn a key in the lock of the luggage compartment lid to the right past a resistance point and remove it in the horizontal position.

This locks the luggage compartment lid and disconnects it from the central locking system. If you then hand over the remote control without the integrated key, refer to page **30**, no access is possible via the luggage compartment lid. This is an advantage when using valet parking, for example.

Unlocking again and opening manually

Turn the key toward the left up to the stop: the luggage compartment lid opens.

▶ If you use the lock to unlock the luggage compartment lid while the alarm system is armed, the alarm will be triggered. You should therefore unlock the vehicle ahead of time. If the alarm is inadvertently triggered: switch off the alarm, refer to page **40**. ◀

Closing

⚠ Make sure that the closing path of the luggage compartment lid is clear, otherwise injuries may result. ◀



The handle recesses on the interior trim of the luggage compartment lid make it easier to pull down.

Emergency release



Pull the lever in the cargo bay. The luggage compartment lid is unlocked.

Sports Wagon: opening and closing rear window

Small items can be loaded and unloaded quickly when the rear window is opened separately.

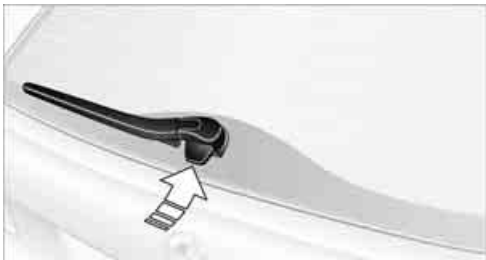

Press the button: the rear window opens somewhat. It can be swung upward.

Press the window closed to close.

 When opening the rear window, the roll-up cover is raised. ◀

 If pointed or sharp-edged objects could strike the rear window while driving, be sure to provide protection around all edges. Failure to do so could result in damage to the heating conductors of the rear window. ◀

Automatic roll-up cover*

When opening the rear window, the roll-up cover is raised, and when the rear window is closed, it is lowered.

 Make sure that the closing area of the roll-up cover is clear of obstructions, otherwise the payload or the roll-up cover may be damaged. ◀

Details on the roll-up cover are provided on page 128.

Sports Wagon: tailgate

Opening from inside



Press button 1 or button 2*: the tailgate opens unless it has been locked.

Opening from outside



Press the button on the tailgate or the  button on the remote control for approx. 1 second: The tailgate opens somewhat. It can be swung upward.

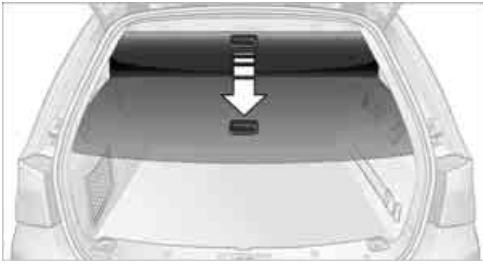

▶ When opening the tailgate, the roll-up cover is raised. Before closing the tailgate, press down the roll-up cover until it engages. ◀

The handle recesses on the interior trim of the tailgate make it easier to pull down.

To close the tailgate, merely press it down gently. The closing process will then be carried out automatically.

Opening manually

In case of an electrical malfunction:

1. From the cargo bay, press out the cover **1** on the tailgate with a screwdriver.

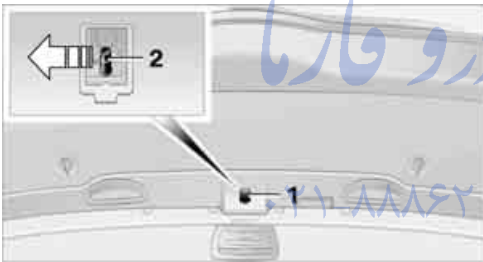

2. Press the locking bar **2** in the direction of the arrow.
3. Open the tailgate and press in the cover again.

The tailgate is locked again as soon as it is closed.

Closing

⚠ Make sure that the closing path of the tailgate is clear, otherwise injuries may result. ◀

Sports Wagon: automatic tailgate operation*

Adjusting opening height

You can adjust how far the tailgate is to open. iDrive, for operating principle refer to page 16.

1. Press the **MENU** button. This opens the start menu.
2. Press the controller to open the **i** menu.
3. Select "Settings" and press the controller.
4. Select "Vehicle / Tires" and press the controller.
5. Change to upper field if necessary. Turn the controller until "Door locks" is selected and press the controller.
6. Select "Tailgate" and press the controller.



7. Turn the controller. The adjustment is applied; the field can be changed.

Opening tailgate

The tailgate opens automatically when you:

- ▷ Press the button on the outside of the tailgate when the vehicle is unlocked.



- ▷ Press button 1 or button 2*.



- ▷ Press the  button on the remote control for approx. 1 second.

 In some country-specific versions, the tailgate can only be opened using the remote control if the vehicle was unlocked first. During opening, the tailgate pivots back and up. Make sure that adequate clearance is available before opening. ◀

Automatic roll-up cover

When the tailgate or rear window are opened, the roll-up cover is raised, and when the tailgate and rear window are closed, it is lowered.

 Make sure that the closing area of the roll-up cover is clear of obstructions, otherwise the payload or the roll-up cover may be damaged. ◀

Details on the roll-up cover are provided on page 128.

Closing tailgate

 Make sure that the closing path of the tailgate is clear, otherwise injuries may result. ◀



The tailgate closes automatically when the button on the inside of the tailgate is pressed.

To interrupt the opening or closing process:

- ▷ Press the button on the inside of the tailgate.
- ▷ Press the button on the outside of the tailgate.

 Closing is not canceled when you put the vehicle into motion. ◀

Alarm system

The concept

The vehicle alarm system responds:

- ▷ When a door, the hood or the luggage compartment lid/tailgate or rear window are opened
- ▷ To movements in the vehicle: interior motion sensor, refer to page 40
- ▷ To changes in the vehicle's tilt if someone attempts to steal the wheels or tow the vehicle
- ▷ To interruptions in battery voltage

Unauthorized operations are briefly signaled by the alarm system:

- ▷ with an acoustic alarm
- ▷ by switching on the hazard warning flashers
- ▷ by flashing the high beams

Arming and disarming alarm system

When you lock or unlock the vehicle, either with the remote control or at the door lock, the alarm system is armed or disarmed at the same time.

The luggage compartment lid/tailgate can also be opened with the system armed using the  button on the remote control, refer to page 36. When the luggage compartment lid/tailgate is closed, it is locked and monitored again.

Switching off alarm

- ▷ Unlock the vehicle using the remote control, refer to page 32.
- ▷ Insert the remote control all the way into the ignition lock.

Indicator lamp displays



- ▷ The indicator lamp under the interior rearview mirror flashes continuously: the system is armed.
- ▷ The indicator lamp flashes after locking: doors, hood, luggage compartment lid/tailgate or rear window are not properly closed. Even if you do not close the alerted area, the system begins to monitor the remaining areas, and the indicator lamp flashes continuously after approx. 10 seconds. However, the interior motion sensor is not activated.
- ▷ The indicator lamp goes out after unlocking: your vehicle has not been disturbed while you were away.
- ▷ The indicator lamp flashes after unlocking until the remote control is inserted into the ignition lock, however for a maximum of approx. 5 minutes: your vehicle has been disturbed while you were away.

Tilt alarm sensor

The tilt of the vehicle is monitored. The alarm system reacts, e.g. in case of an attempted wheel theft or towing.

Interior motion sensor

In order for the interior motion sensor to function properly, the windows and glass sunroof* must be completely closed.

Avoiding unintentional alarms

The tilt alarm sensor and interior motion sensor may be switched off at the same time. This prevents unintentional alarms, e.g. in the following situations:

- ▷ In two-level garages
- ▷ When transporting on car-carrying trains, by sea or on a trailer
- ▷ When animals are to remain in the vehicle

Switching off tilt alarm sensor and interior motion sensor

Press the  LOCK button on the remote control again as soon as the vehicle is locked.

The indicator lamp lights up briefly and then flashes continuously. The tilt alarm sensor and the interior motion sensor are switched off until the next time the vehicle is unlocked and subsequently locked again.

Comfort access*

Comfort access allows you to access your vehicle without having to hold the remote control in your hand. It is sufficient to carry the remote control with you, e.g. in your jacket pocket. The vehicle automatically detects the associated remote control in the immediate vicinity or in the interior.

Comfort access supports the following functions:

- ▷ Unlocking/locking vehicle
- ▷ Comfort closing
- ▷ Opening luggage compartment lid/tailgate separately

- ▶ Sports Wagon: opening rear window separately
- ▶ Starting engine

Functional requirement

- ▶ The vehicle or the luggage compartment lid/tailgate can only be locked if the vehicle detects that the remote control you are carrying is outside the vehicle.
- ▶ The next unlocking and locking cycle is not possible until after approx. 2 seconds.
- ▶ The engine can only be started if the vehicle detects that the remote control is located in the vehicle.

Comparison with ordinary remote control

You can control the functions mentioned previously with the comfort access or by pressing the buttons on the remote control. Therefore, please familiarize yourself with the information on opening and closing beginning on page 30 beforehand.

The special features when using comfort access are described in the following.

- ▶ Should a short delay occur when opening or closing the windows or the glass sunroof, the system is checking whether a remote control is located in the vehicle. Please repeat opening or closing if necessary. ◀

Unlocking

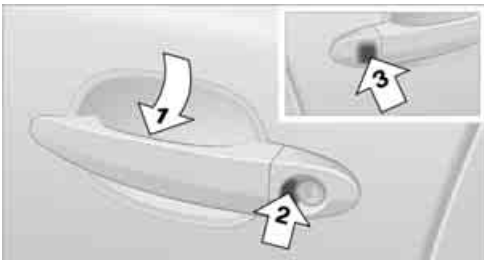

Grasp a door handle fully, refer to arrow 1, but do not touch the surfaces, arrow 2 or 3 when doing so. This corresponds to pressing the  button.

Locking

- ▶ On the driver's door, touch the highlighted surface, arrow 2, with a finger for approx. 1 second, but do not grasp the door handle.
- ▶ On the remaining doors, touch the highlighted surface, arrow 3, with the back of your hand for approx. 1 second, but do not grasp the door handle.

This corresponds to pressing the  LOCK button.

- ▶ Please make sure that the ignition and all electronic systems/consumers are switched off before locking to save the battery. ◀

Comfort closing

Hold a finger or the back of your hand against the surface, arrow 2 or 3, but do not grasp the door handle while doing so.

The windows and the glass sunroof* are closed.

- ▶ Watch during the closing process to be sure that no one is injured. Removing the hand from the door handle stops the closing process immediately. ◀

Opening luggage compartment lid/tailgate separately

Press the button on the luggage compartment lid/tailgate. This corresponds to pressing the  button.

- ▶ If a remote control accidentally left in the cargo bay is detected in the locked vehicle after closing the luggage compartment lid/tailgate or the rear window, the lid or rear window opens again. The hazard warning flashes flash and a signal* sounds. ◀

Sports Wagon: opening rear window separately

Press the button on the rear window, refer to page 37.

Switching on radio readiness

By pressing the Start/Stop button, you switch on the radio readiness, refer to page 62.

 When doing so, do not depress the brake or clutch pedal, otherwise the engine will start immediately. ◀

Starting engine

You can start the engine or switch on the ignition if a remote control is located in the interior of the vehicle. It is not necessary to insert a remote control into the ignition lock, refer to page 62.

If you take the remote control with you when leaving the vehicle with the engine running, a warning lamp lights up. In addition, a message appears on the Control Display. As long as no remote control is detected, it is only possible to restart the engine within approx. 10 seconds after it is switched off.

Switching off engine with automatic and sport automatic transmission

The engine can only be switched off in transmission position P, refer to page 63.

To switch off the engine in transmission position N, the remote control must be inserted in the ignition lock.

Before driving into a car wash with automatic and sport automatic transmission

1. Insert remote control into ignition lock.
2. Depress brake pedal.
3. Engage transmission position N.
4. Switch off the engine.

The vehicle can roll.

Malfunction

The comfort access function may malfunction due to local radio waves. Then open or close the vehicle with the buttons on the remote control or with a key. To start the engine following this, insert the remote control in the ignition lock.

When unlocking or locking/comfort closing do not simultaneously grasp the door handle and touch the surfaces, arrow 2 or 3. Otherwise, you may limit the function.

Replacing battery

If the battery of the remote control is dead, a message will appear in the Control Display.

1. Remove integrated key from remote control, refer to page 30.
2. Remove cover.



3. Lay in new battery with positive side facing upward.
4. Press cover closed.

 Return used battery to a recycling collection point or to your BMW center. ◀

Windows

 To prevent injuries, exercise care when closing the windows and keep them in your field of vision until they are shut. Always take along the remote control when you leave the vehicle, otherwise children could, for example, operate the windows and injure themselves. ◀

Opening, closing



- ▷ Press switch to resistance point:
The window continues to open as long as you keep the switch pressed.

- ▷ Press switch beyond resistance point: The window opens automatically. Pressing the switch again stops the opening movement.

You can close the windows in the same manner by pulling the switch.

Separate switches for the rear windows are located in the rear.

For information on convenient operation via the remote control or door lock, refer to page 33 or 34.

For information on comfort closing with comfort access, refer to page 41.

After switching off ignition

You can still operate the windows with the remote control removed or the ignition switched off for approx. 1 minute, as long as neither of the front doors has been opened.

Pinch protection system

If the closing force exceeds a specific value as a window closes, the closing action is interrupted and the window reopens slightly.

 Despite the pinch protection system, inspect the window's travel path prior to closing it, as the safety system might fail to detect certain kinds of obstructions, such as thin objects, and the window would continue closing.

Do not install any accessories in the range of movement of the windows, otherwise the pinch protection system will be impaired. ◀

Closing without pinch protection system

In case of danger from outside or if, for example, ice on the window prevents normal closing, proceed as follows:

1. Pull the switch beyond the resistance point and hold. The pinch protection system is limited and the window opens slightly if the closing force exceeds a certain value.
2. Pull the switch beyond the resistance point and hold again within approx. 4 seconds.

The window closes without the pinch protection system.

Safety switch



With the safety switch, you can prevent the rear windows from being opened or closed via the switches in the rear passenger area, by children, for example. The LED lights up when this safety feature is activated.

 Always press the safety switch when children ride in the rear, otherwise uncontrolled closing of the windows could lead to injuries. ◀

Electric glass sunroof*

The glass sunroof is ready for operation when the ignition is switched on, refer to page 62.

 To prevent injuries, exercise care when closing the glass sunroof and keep it in your field of vision until it is closed. Always take along the remote control when you leave the vehicle, otherwise children could, for example, operate the roof and injure themselves. ◀



Raising

Press the switch.

The closed glass sunroof is raised and the sliding visor opens slightly.

 Do not use force to close the sliding visor with the glass sunroof in its raised position, otherwise the mechanism will be damaged. ◀

Opening, closing

- ▷ Slide the switch back to the resistance point.
The glass sunroof and the sliding visor open together for as long as you hold the switch in this position.
- ▷ Briefly press the switch back beyond the resistance point.
The glass sunroof and the sliding visor open automatically. Briefly pressing the switch stops the motion.

In a similar manner, the glass sunroof closes when you slide the switch forward. The sliding visor remains open and can be closed by hand.

For information on convenient operation via the remote control or door lock, refer to page 33 or 34.

For information on comfort closing with comfort access, refer to page 41.

Opening and closing automatically

Briefly press the switch beyond the resistance point.

The following movements are also automatic:

- ▷ Press the switch with the sunroof open: the sunroof is raised all the way.
- ▷ When the sunroof is raised, briefly press the switch in the opening direction: The sunroof is opened all the way.

Briefly pressing the switch stops the motion.

Pinch protection system

If the glass sunroof encounters resistance when closing from roughly the center of the roof opening or when closing from the raised posi-

tion, the closing action is interrupted and the glass sunroof reopens a short way.

 Despite the pinch protection system, inspect the sunroof's travel path prior to closing it, as the safety system might fail to detect certain kinds of obstructions, such as very thin objects, and the sunroof would continue closing. ◀

Closing without pinch protection system

In case of danger from outside, slide the switch forward beyond the resistance point and hold. The roof closes without the pinch protection system.

Following interruptions in electrical power supply

After a power loss, the sunroof may only respond to the raise command. Then have the system initialized. BMW recommends having this work done by your BMW center.

Moving manually*

In the event of an electrical malfunction, you can move the glass sunroof manually.

1. Fold the cover panel down, if necessary using a screwdriver from the onboard tool kit, refer to page 243.



2. Insert the Allen wrench* into the opening provided. Move the glass sunroof in the

desired direction. The arrow below indicates the rotation direction for closing.



Sports Wagon: Panorama glass sunroof

The panorama glass sunroof is ready for operation when the ignition is switched on, refer to page 62.

 To prevent injuries, exercise care when closing the panorama glass sunroof and keep it in your field of vision until it is closed. Always take along the remote control when you leave the vehicle, otherwise children could, for example, operate the roof and injure themselves. ◀



Raising

Press the switch.

The closed sunroof is raised and the sliding visor opens slightly.

 Do not use force to close the sliding visor with the glass sunroof in its raised position, otherwise the mechanism will be damaged. ◀

Opening, closing

Sliding visor

You can move the sliding visor independently with the sunroof closed or raised.

- ▷ Slide the switch back to the resistance point.
The sliding visor opens as long as you keep the switch in this position.
- ▷ Briefly press the switch back beyond the resistance point.
The sliding visor will open automatically. Briefly pressing the switch stops the motion.

You can close the sliding visor in a similar manner by sliding the switch forwards.

Panorama glass sunroof

With the sliding visor open, proceed as described under Sliding visor.

For information on convenient operation via the remote control or door lock, refer to page 33 or 34.

For information on comfort closing with comfort access, refer to page 41.

Opening and closing sunroof and sliding visor together

Briefly press the switch beyond the resistance point twice consecutively.

Briefly pressing the switch stops the motion.

Comfort modes

- ▷ Press the switch twice with the sunroof open:
The sunroof is raised.
- ▷ When the sunroof is raised, briefly press the switch twice in the opening direction:
The sunroof is opened all the way.

Comfort position

The sunroof is not completely open in the comfort position. This reduces the wind noises in the interior.

Each time the panorama glass sunroof is completely opened or closed, it stops in the comfort position. If desired, continue the motion following this with the switch.

Pinch protection system

If the panorama glass sunroof or sliding visor encounter resistance when closing from roughly one third of the sunroof opening or when closing from the raised position, the closing action is interrupted and the panorama glass sunroof and sliding visor reopen a little.

 Despite the pinch protection system, inspect the sunroof's travel path prior to closing it, as the safety system might fail to detect certain kinds of obstructions, such as very thin objects, and the sunroof would continue closing. ◀

Closing without pinch protection system

In case of danger from outside, slide the switch forward beyond the resistance point and hold. The roof closes without the pinch protection system.

Following interruptions in electrical power supply

After a power loss, the sunroof may only respond to the raise command. Then have the system initialized. BMW recommends having this work done by your BMW center.

Moving manually*

In the event of an electrical malfunction, you can move the sunroof manually.

1. Fold back the cover, using the screwdriver from the toolkit at the points indicated if necessary, refer to page 243.



2. Insert the Allen wrench* into the opening provided. Move the sunroof in the desired direction. The arrow below indicates the rotation direction for closing.



تلفن شبانه روزی: ۰۲۱-۸۸۸۶۲۰۸۵

SOS.com

Adjusting

Sitting safely

The ideal sitting position can make a vital contribution to relaxed, fatigue-free driving. In the interaction with the safety belts, the head restraints and the airbags, the sitting position plays an important role in an accident. To ensure that the safety systems operate with optimal efficiency, we strongly urge you to observe the instructions contained in the following section.

For additional information on transporting children safely, refer to page 58.

Airbags

 Always maintain an adequate distance between yourself and the airbags. Always hold the steering wheel by its rim with hands at the 9 o'clock and 3 o'clock positions, to minimize the risk of injuries to your hands and arms in the event of airbag deployment.

No one and nothing is to come between the airbags and the seat occupant.

Do not use the cover of the front airbag on the front passenger side as a storage area. Make sure that the front passenger is sitting correctly and does not rest feet or legs on the instrument panel, otherwise leg injuries can occur if the front airbags are triggered.

Make sure that occupants do not rest their head on the side or head airbags, otherwise injuries can occur if the airbags are triggered. ◀

Even if you adhere to all the instructions, injuries resulting from contact with airbags cannot be fully excluded, depending on the circumstances. The ignition and inflation noise may provoke a mild hearing loss in extremely sensitive individuals. This effect is usually only temporary.

For airbag locations and additional information on airbags, refer to page 100.

Head restraints

A correctly adjusted head restraint reduces the risk of spinal injury in the event of an accident.

 Adjust the head restraint so that its center is approx. at ear level. Otherwise there is increased danger of injury in the event of an accident. ◀

Head restraints, refer to page 51.

Safety belts

Before every drive, make sure that safety belts are being worn at all of the occupied seats. Airbags complement the safety belt as an additional safety device, but they do not represent a substitute.

Your vehicle is provided with five seats, which are all equipped with a safety belt.

 Never allow more than one person to wear a single safety belt. Never allow infants or small children to ride in a passenger's lap. Make sure that the belt lies low around the hips in the lap area and does not press on the abdomen. The safety belt must not lie across the neck, rub against sharp edges, be routed over solid or breakable objects or be pinched. Wear the safety belt without twisting, snugly across the lap and shoulders, as close to the body as possible. Otherwise the belt can slip over the hips in the lap area in a frontal impact and injure the abdomen. Avoid wearing clothing that prevents the belt from fitting properly and pull the belt in the upper body area periodically to readjust the tension, in order to avoid a reduction in the restraint of the safety belt. Sports Wagon: if the center safety belt in the rear is used, the larger backrest half must be locked, refer to page 128, otherwise the middle safety belt has no restraining action. ◀

Safety belts, refer to page 52.

Seats

Note before adjusting

⚠ Never attempt to adjust your seat while the vehicle is moving. The seat could respond with unexpected movement, and the ensuing loss of vehicle control could lead to an accident.

Also on the passenger side, do not incline the backrest too far to the rear while the vehicle is being driven, otherwise there is a danger in the event of an accident of sliding under the safety belt, eliminating the protection normally provided by the belt. ◀

Please follow the instructions on damage to safety belts provided on page 53 and the information on the active front head restraints on page 51.

Adjusting seat

⚠ To ensure that the safety systems continue to provide optimized protection, please observe the adjustment instructions on page 47. ◀

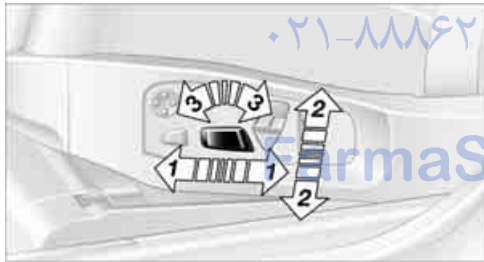

- 1 Longitudinal direction
- 2 Height
- 3 Angle



4 Backrest

Adjusting comfort seat*

In this seat, you can also adjust:

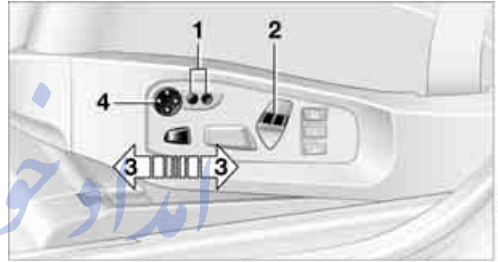

- 1 Backrest width
- 2 Shoulder support
- 3 Thigh support
- 4 Lumbar support*

Shoulder support

the adjustable upper backrest also supports the back in the shoulder region. This provides a relaxed driving position and helps relieve stress on the shoulder muscles.

Lumbar support*



You can also adjust the contour of the backrest to obtain additional support in the lumbar region.

The upper hips and spinal column receive supplementary support to help you maintain a relaxed, upright sitting position.

- ▷ Increase or decrease curvature: press front or rear section of switch.
- ▷ Shift curvature up or down: press upper or lowers section of switch.

Adjusting active backrest width*

First set a comfortable backrest width, see above. Based on the backrest width set, the lateral support is automatically adapted to the current driving situation.

The adaptation of the backrest width and the speed of the adjustment vary depending on the program. You can select from among three programs from comfort to sport.

Button with three LEDs



Press button once per program:

- ▷ "Comfort": one LED
- ▷ "Normal": two LEDs
- ▷ "Sport": three LEDs

To deactivate: Press button longer.

Button with one LED



Press the button repeatedly until the desired program is shown on the Control Display. The LED in the button lights up.

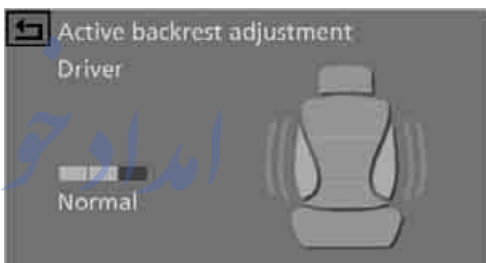

To deactivate: Press button longer.

Easy entry/exit*

To facilitate entry and exit, the backrest width temporarily opens all the way.

Seat, mirror and steering wheel memory*

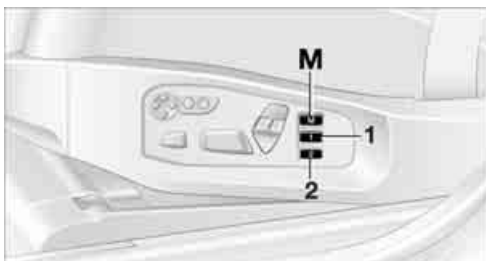

You can store and request two different positions for the driver's seat and passenger seat*, exterior rearview mirrors, and steering wheel.

The adjustment of the lumbar support is not stored in the memory.

Storing

1. Switch on radio readiness or ignition, refer to page 62.
2. Set the desired seat, exterior mirror and steering wheel positions.
3. Press the **M** button:
The LED in the button lights up.
4. Press the desired memory button **1** or **2**:
The LED goes out.

Requesting

 Do not request a position from the memory while the vehicle is moving. There is a risk of accident from unexpected movement of the seat or steering wheel. ◀

Comfort mode

1. Open the driver's door after unlocking or switch on radio readiness.
2. Briefly press the desired memory button **1** or **2**.

The system cancels the adjustment procedure when you briefly press one of the seat adjustment switches or one of the memory buttons.

Safety feature

1. Close the driver's door and switch the ignition on or off.
2. Press the desired memory button **1** or **2** and maintain pressure until the adjustment process has been completed.

If the **M** button was pressed inadvertently: press the button again; the LED goes out.

Requesting with remote control

The last positions of the driver's seat, the exterior rearview mirrors, and steering wheel are stored for the remote control currently in use.

You can choose when the position is requested:

- ▷ Request when unlocking vehicle
- ▷ Request when opening driver's door

 When using this feature, always make sure that the footwell behind the driver's seat is empty and unobstructed. Failure to do so could cause injury to persons or damage to objects behind the seat as a result of a rearward movement of the seat. ◀

The system cancels the adjustment procedure when you briefly press one of the seat adjustment switches or one of the memory buttons.

iDrive, for operating principle refer to page 16.

1. Open the start menu.
2. Press the controller to open the **i** menu.
3. Select "Settings" and press the controller.
4. Select "Vehicle / Tires" and press the controller.
5. Change to upper field if necessary. Turn the controller until "Door locks" is selected and press the controller.

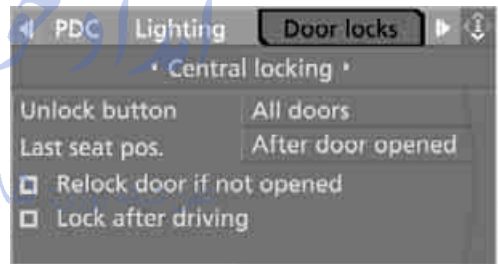

6. Select "Central locking" and press the controller.
7. Select "Last seat pos." and press the controller.
8. Select "After unlocking" or "After door opened".



9. Press the controller.

To cancel the request:
Select "Deactivated" and press the controller.

Head restraints

A correctly adjusted head restraint reduces the risk of spinal injury in the event of an accident.

⚠ Adjust the head restraint so that its center is approximately at ear level. Otherwise there is increased danger of injury in the event of an accident. Only remove the head restraints if no one will be sitting on the seat in question. Reinstall the head restraints before transporting passengers, as otherwise the head restraint cannot provide its protective function. ◀

Active front head restraints

In the event of a rear-end collision of sufficient severity, the active head restraint reduces the distance to the head.

⚠ Do not use seat covers or head restraint covers that could impede the proper functioning of the active head restraint. Otherwise, there is no assurance that the active head restraint will perform its protective function and it is not possible to take advantage of its injury-reducing potential in the event of a rear-end collision.

Have the active head restraints reset after they are triggered in a rear-end collision. Only have this work carried out by a BMW center or a workshop that works according to BMW repair procedures with correspondingly trained personnel. Otherwise, this safety equipment will not function properly. ◀

▶ Please contact a BMW center if you wish to have the front head restraints removed and installed. ◀

Front seats: height adjustment

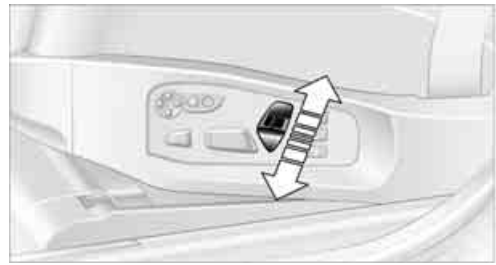

Front seats: adjusting distance to the back of the head

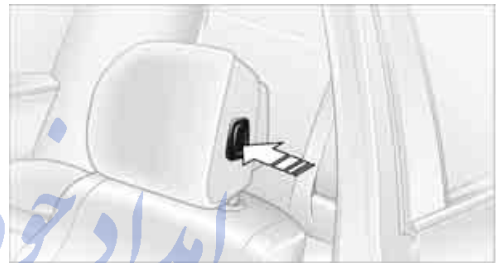

- ▷ Forward: pull up.
- ▷ Back: push the button and slide the headrest cushion toward the rear.

⚠ Do not place any objects behind the headrest cushion. Otherwise, you can impair the proper function of the head restraint. ◀

Comfort seat*

You can adjust the distance to the back of the head with the shoulder support, refer to page 48.

Adjusting side extensions



You can fold the side extensions on the head restraint forward for increased lateral support in the resting position.

Rear seats: height adjustment

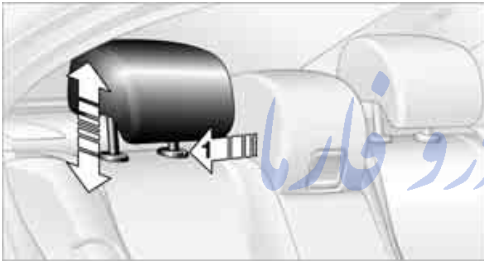

- ▷ To raise: pull up.
- ▷ To lower: press the button, arrow 1, and push the head restraint downward.

Removing

1. Pull the head restraint upward to the stop.
2. Press the button, arrow 1, and pull the head restraint all the way out.

Safety belts

⚠ To ensure that the safety systems continue to provide optimized protection, please observe the adjustment instructions on page 47. ◀

Before every drive, make sure that safety belts are being worn at all of the occupied seats. Airbags complement the safety belt as an addi-

tional safety device, but they do not represent a substitute.



Fastening

Make sure you hear the latch plate engage in the belt buckle.

Safety belt reminder for driver's seat and passenger seat*



The indicator lamp lights up and a signal sounds. A message also appears on the Control Display. Please check whether the safety belt is correctly positioned.

The safety belt reminder is operative at speeds above approx. 5 mph/8 km/h. It can also be activated if objects are placed on the passenger seat.

Releasing

1. Grasp the belt firmly.
2. Press the red button in the buckle.
3. Guide the belt into its reel.

The shoulder strap's anchorage point will be correct for adult seat occupants of every build if the seat is correctly adjusted, refer to page 48.

The two rear safety belt buckles integrated into the rear seat are for passengers sitting on the

left and right. The belt buckle embossed with the word CENTER is intended exclusively for use by passengers riding in the center position.

Damage to safety belts

⚠ When subjected to strain due to an accident or in the event of damage, replace the safety belts, the belt tensioners, and any child restraint systems and have the belt anchor points checked. Only have this work carried out at a BMW center or at a workshop that works according to BMW repair procedures with correspondingly trained personnel. Otherwise correct operation of this safety equipment is not guaranteed. ◀

Seat heating*

Front

The appearance and arrangement of the buttons may vary depending on the equipment.



- 1 Seat heating, three LEDs
- 2 Seat heating, one LED
- 3 Seat heating with active seat ventilation*

Press the respective button once per temperature level. The temperature level is shown on

the Control Display with buttons **2** and **3**. The maximum temperature is supplied when three LEDs are lit.

The temperature is reduced and if need be, the heating is switched off in order to reduce the load on the battery. The LEDs remain lit.

To switch off: Press button longer.

Temperature distribution without active seat ventilation

The heat output can be distributed variously in the seat cushion and the backrest.

iDrive, for operating principle refer to page 16.

1. Open the start menu.
2. Move the controller to the left to open "Climate".
3. Select "Seat heater distribution" and press the controller.
4. Move the controller to the left or right to select "Driver" or "Passenger".



5. Turn the controller to adjust the distribution. The setting is applied.

Temperature distribution with active seat ventilation

The heat output can be distributed variously in the seat cushion and the backrest.

iDrive, for operating principle refer to page 16.

1. Open the start menu.
2. Move the controller to the left to open "Climate".

3. Select "Driver's seat climate" or "Passenger's seat climate" and press the controller.



Turn the controller to adjust the distribution. The setting is applied.

Press the respective button once per ventilation level. The ventilation level appears on the Control Display. The maximum level is supplied when three LEDs are lit.

The air quantity is reduced and if need be, the ventilation is switched off in order to reduce the load on the battery. The LEDs remain lit.

To switch off: Press button longer.

 The highest level is used for rapid cooling, e.g. when the vehicle has become heated up. After a short time, the system is automatically switched down one level in order to prevent excessive cooling. ◀

Rear



Operation similar to front seat heating; two temperature levels, without temperature distribution.

Active seat*

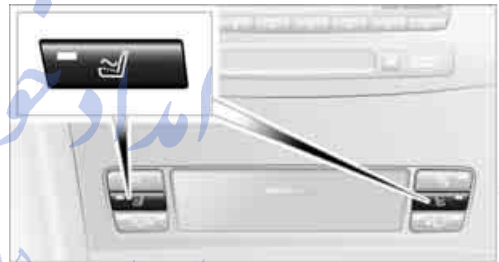

The seat cushion is actively varied by alternately raising and lowering the right and left half of the seat cushion. This reduces muscular tension and fatigue to help prevent lower back pain.

Press the button to switch on; the LED lights up.

The action of the system is reduced and if need be, switched off in order to reduce the load on the battery. The LED remains lit.

If you switch off the active seat, it can take up to 1 minute before the two halves of the seat cushion have returned to their initial position.

Active seat ventilation*

The appearance and arrangement of the buttons may vary depending on the equipment.



- 1 Active seat ventilation
- 2 Active seat ventilation with seat heating

Mirrors

Exterior mirrors

 The mirror on the passenger's side is more curved than the driver's mirror.

Objects reflected in the mirror are closer than they appear. Do not estimate the distance of following traffic based on what you see in the mirrors, otherwise there is an increased accident risk. ◀



- 1 Adjusting
 - 2 Switching to the other mirror or to the automatic curb monitor
 - 3 Folding mirrors in and out*
- Storing the mirror positions, refer to Seat, mirror and steering wheel memory on page 49.

Adjusting manually

You can also adjust the mirrors manually by pressing against the outer edges of their mirror glass.

Folding mirrors in and out*

Pressing button **3** allows you to fold mirrors in and out up to a speed of approx. 20 mph/30 km/h. This is advantageous, for example, in car washes, narrow streets or for bringing mirrors that have been manually folded in back into the correct position. Mirrors that were folded in are folded out automatically at a speed of approx. 25 mph/40 km/h.

⚠ Before going through a car wash, fold the mirrors in manually, or with button **3**, otherwise they could be damaged, depending on the width of the car wash system. ◀

Automatic heating

Below a certain outdoor temperature, both exterior mirrors are heated whenever the engine is running or the ignition is switched on.

Tilting down passenger-side exterior mirror – automatic curb monitor*

Activating

1. Slide switch into the driver's side mirror position, arrow **1**.



2. Shift into reverse or move selector lever into position R.
The mirror glass tilts downward somewhat on the passenger's side. This allows the driver to see the area immediately adjacent to the vehicle – such as a curb – when parking, etc.

Deactivating

Slide switch into the passenger side mirror position, arrow **2**.

Interior rearview mirror

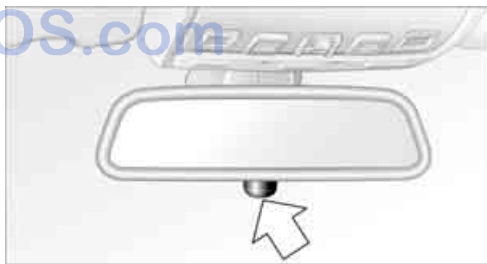

To reduce the dazzle effect of following vehicles at night, turn the knob.

Interior and exterior mirrors, automatic dimming feature*

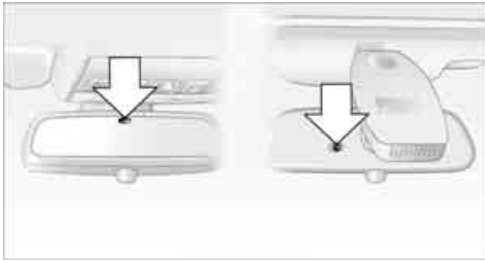

This feature is controlled by two photocells in the inside rearview mirror, one on the front and one on the back.

For trouble-free operation, keep the photocells clean and do not cover the area between the interior rearview mirror and the windshield. Do not attach stickers of any kind to the windshield in front of the mirror, either.

Steering wheel

Adjusting

! Do not adjust the steering wheel while the vehicle is moving. There is a risk of accident as the result of unexpected movement. ◀

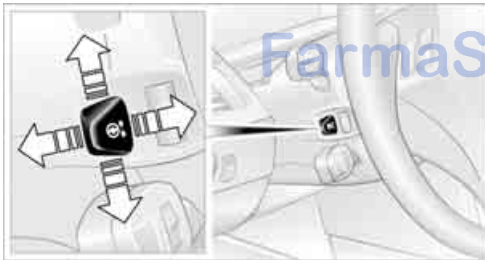

The steering wheel can be adjusted in four directions.

Storing steering wheel positions, refer to Seat, mirror and steering wheel memory on page 49.

Easy entry/exit*

To facilitate entry and exit, the steering wheel temporarily moves into the uppermost position.

Steering wheel heating*



Press the button.

When the steering wheel heater is operating, the LED in the button lights up.

Programmable buttons* on steering wheel



You can program the buttons individually.

The setting is stored for the remote control currently in use.

iDrive, for operating principle refer to page 16.

1. Press the **MENU** button.
This opens the start menu.
2. Press the controller to open the **i** menu.



3. Select "Settings" and press the controller.

4. Select "Steering wheel buttons" and press the controller.

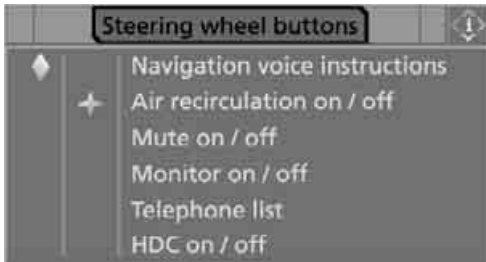

A list of various functions appears:

- ▷ "Navigation voice instructions"
Voice instructions for the navigation system*
- ▷ "Air recirculation on / off"
To permanently shut off outside air, refer to AUC Automatic recirculated-air control on page 117
- ▷ "Mute on / off"
To mute the audio sources
- ▷ "Monitor on / off"
To switch the Control Display on/off
- ▷ "Telephone list"*
To show/hide the phone book or last displayed list of stored phone numbers
- ▷ "HDC on / off"
To switch HDC Hill Descent Control* on/off
- ▷ "Next entertainment source"
To change the audio source
- ▷ "Night Vision on / off"
To switch BMW Night Vision* on/off

5. Select the desired function and press the controller.

6. Select the button if necessary and press the controller.



You can operate the selected function using the corresponding button.

Operating the function

Press the corresponding button on the steering wheel.

If you have programmed "Navigation voice instructions" for one of the buttons:

- ▷ Switch voice instructions on/off:
Press button longer.
- ▷ To repeat the last voice instruction:
Press the button.

فارما سوس
تلفن شبانه روزی: ۰۸۵ ۲۱۱۱۴۲۰۸۵
FarmaSOS.com

Transporting children safely

The right place for children

⚠ Do not leave children unattended in the vehicle, otherwise they could endanger themselves and other persons, e.g. by opening the doors. ◀

Children always in the rear

Accident research shows that the safest place for children is on the rear seat.

⚠ Children younger than 13 years of age or with a height under 5 ft/150 cm may only be transported in the rear in child restraint systems which correspond to the age, weight and height of the child. Otherwise there is an increased danger of injury in an accident. ◀

Children 13 years of age or older must wear a safety belt as soon as a suitable child restraint system can no longer be used due to their age, size and weight.

Exception for front passenger seat

⚠ Should it ever be necessary to use a child restraint system on the front passenger seat, the front and side airbags on the passenger side must first be deactivated. Otherwise, there is an increased risk of injury for the child if the airbags are triggered, even with a child restraint system. ◀

For more information on automatic deactivation of the front passenger airbags, refer to page 101.

Installing child restraint systems

⚠ Observe the child restraint system manufacturer's instructions for selection, installation and use of the child restraint systems. Otherwise the degree of protection may be reduced. ◀

Backrest width* on front passenger seat

⚠ Open the backrest width setting of the front passenger seat all the way. After mounting the child's seat, deactivate the active backrest width adjustment and do not call up any memory position. Otherwise this limits the stability of the child's seat on the front passenger seat. ◀

1. After unlocking the vehicle, sit on the front passenger seat and close the door to call up the memory position.
2. Completely open the backrest width adjustment, refer to page 48.
3. Deactivate active backrest width adjustment, refer to page 49.
4. Install child's seat.

Child seat security



All rear safety belts and the safety belt for the front passenger can be locked against pulling out to secure child restraint systems.

Locking safety belt

1. Secure the child restraint system with the belt.
2. Pull out the belt webbing completely.
3. Allow the belt webbing to retract and pull taut against the child restraint system. The safety belt is locked.

Unlocking safety belt

1. Open the belt buckle.
2. Remove the child restraint system.
3. Allow the belt webbing to retract completely.

LATCH child restraint fixing system

LATCH: Lower Anchor and Tethers for Children.

 Follow the system manufacturer's instructions on installation and use of LATCH child restraint systems in order not to impair their protective function. ◀

Before attaching the LATCH child's seat, pull the belt away from the region of the child restraint fixing system.

 Make sure that the LATCH mounts have properly clicked into place and that the child restraint system is resting snugly against the backrest. Otherwise, the protective action may be impeded. ◀

Sedan: rear seats

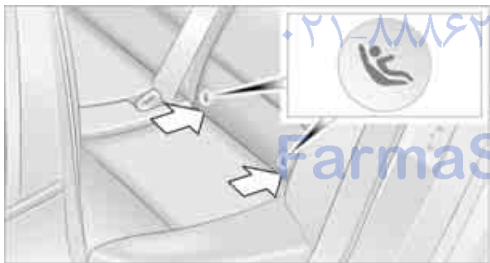

The anchor points for the LATCH anchors are located at the positions indicated by arrows in the gap between the seat and the backrest.

Sedan: rear seats with through-loading system*

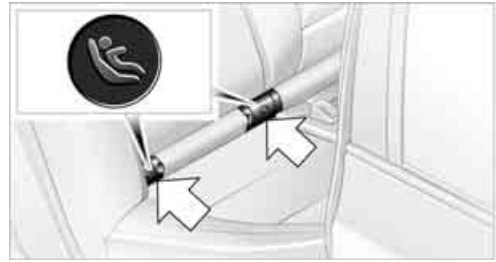

The anchor points for the LATCH anchors are located behind the indicated protective caps. Remove the cover caps before mounting the child's seat.

Sports Wagon: rear seats



The anchor points for the lower LATCH anchors are located behind the labeled covers. The anchor points for the LATCH anchors are located behind the indicated protective caps and are covered again after the child's seat is removed.

Child restraint system with tether strap

 Only use the tether-strap mounting points to secure child restraint systems, otherwise the mounting points could be damaged. ◀

Sedan

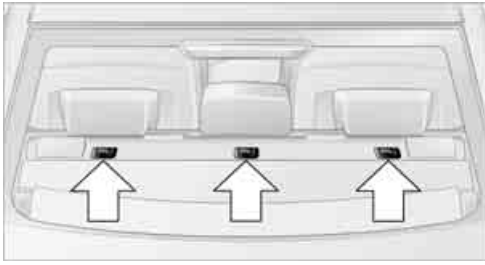

There are three additional mounting points for child restraint systems with a tether strap, refer to arrows. Fold the corresponding mounting point upward before using.

Sports Wagon

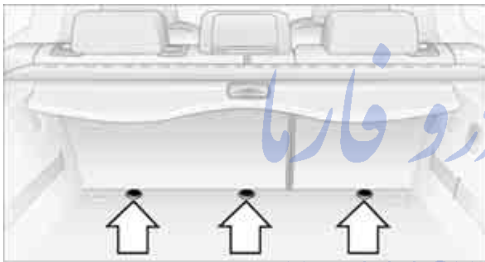

Three additional mounting points for child restraint systems with a tether strap are provided under covers in the cargo bay floor, refer to arrows. Remove the corresponding covers before use.

Placement of tether strap

⚠ Make sure that the upper retaining strap is not routed over sharp edges and does not twist on its way to the upper mounting point; otherwise, the belt may not properly secure the child restraint system in the event of an accident. ◀

Outer rear seat, Sedan

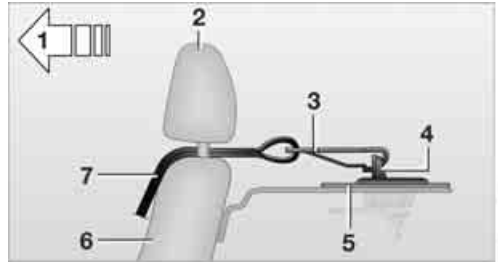

Outer rear seats, Sports Wagon

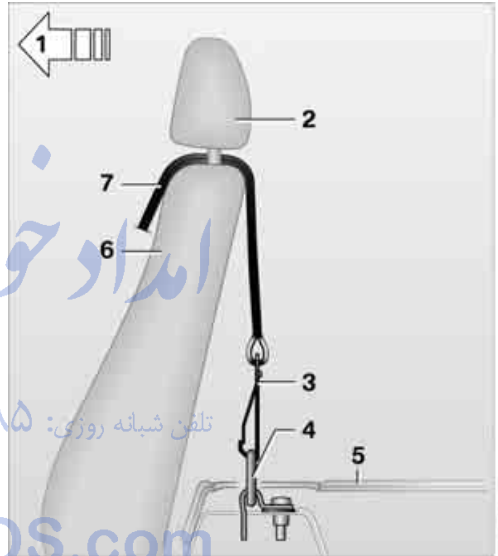

- 1 Direction of travel
- 2 Head restraints
- 3 Hook of upper retaining strap
- 4 Mounting point
- 5 Rear window shelf/luggage compartment floor
- 6 Backrest
- 7 Upper retaining strap of child restraint system

Fold upward or remove covers before using the mounting points.

1. Slide the head restraint upward.
2. Thread the upper retaining strap between the head restraint supports.

3. Sports Wagon: thread the retaining strap between the backrest and the roll-up cover. Make sure that the rear backrest is locked in position.

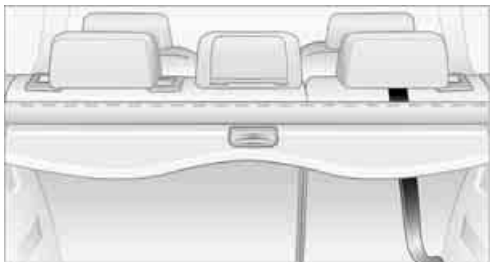

4. Attach the retaining strap hook to the mounting point.
5. Slide the head restraint into the bottom position.
6. Pull the retaining strap taut.

Center rear seat

1. Fold the center armrest somewhat toward the front.
2. Guide retaining strap through the opening.



3. Fold back the center armrest.
4. Sports Wagon: thread the retaining strap between the backrest and the roll-up cover. Make sure that the rear backrest is locked in position.



5. Attach the retaining strap hook to the mounting point.
6. Pull the retaining strap taut.

On trips

! If the vehicle is equipped with rear side airbags, make sure that children do not lean out of the child's seat towards the door panels. Otherwise injuries can be caused if the side airbags are triggered. ◀

Child-safety locks for rear doors

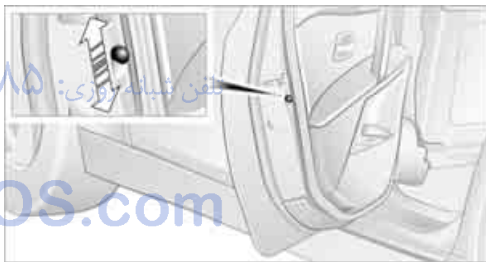

Slide down the safety lever on the rear doors: the door can now be opened from the outside only.

Safety switch for power windows

Always press the safety switch for the power windows, refer to page 43, when children are riding in the rear of the vehicle.

Driving

Ignition lock

Inserting remote control into ignition lock

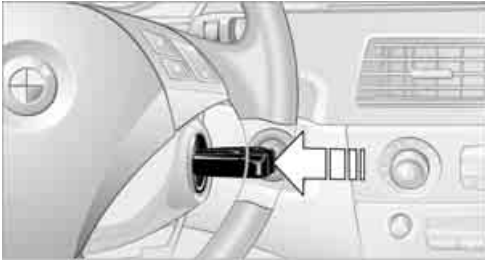

Insert the remote control all the way into the ignition lock.

Radio readiness switches on. Some electronic systems/consumers are ready for operation.

Comfort access*

With comfort access, only insert the remote control into the ignition lock in exceptional cases, refer to page 40.

Removing remote control from ignition lock

⚠ Do not pull the remote control out of the ignition lock using force, as otherwise damage may result. ◀

Before removing the remote control, first press it in as far as possible to release the locking device.

The ignition is switched off if it was still switched on.

Automatic and sport automatic transmission

The remote control can only be removed when transmission position P is selected: interlock.

Start/Stop button



Pressing the Start/Stop button switches the radio readiness or the ignition on and off.

▶ The engine is started when you press the Start/Stop button and depress the clutch if the car has manual transmission or the brake if the car has automatic transmission. ◀

Radio readiness

Some electronic systems/consumers are ready for operation. The time and outside temperature are displayed in the instrument cluster.

Radio readiness is switched off:

- ▶ when the remote control is removed from the ignition lock
- ▶ with comfort access* by touching the surface on the door handle, refer to Locking on page 41

Ignition on

All electronic systems/consumers are ready for operation. The odometer and the trip odometer are displayed in the instrument cluster, refer to page 79.

▶ Please switch off the ignition and the electronic systems/consumers which are not required when the engine is not running to save the battery. ◀

Radio readiness and ignition switched off

All indicator and warning lamps in the instrument cluster go out.

Starting the engine

 Do not run the engine in closed rooms, otherwise the inhalation of toxic exhaust gases can cause unconsciousness and death. The exhaust gases contain carbon monoxide, an odorless and colorless, but highly toxic gas. Never leave an unattended vehicle with the engine running, as such a vehicle represents a potential safety hazard.

Before leaving the vehicle with the engine running, select the idling position, or shift the transmission into position P and firmly apply the handbrake, otherwise the vehicle can begin to roll. ◀

 Avoid frequent starting in quick succession or repeated starting attempts in which the engine does not start. Otherwise, the fuel is not burned or inadequately burned and there is a danger of overheating and damaging the catalytic converter. ◀

Do not allow the engine to warm up by leaving it running while the vehicle remains stationary. Instead, begin to drive at a moderate engine speed.

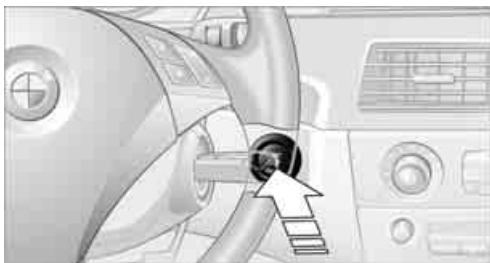

Manual transmission

Remote control in ignition lock or with comfort access in vehicle, refer to page 40.

1. Depress brake pedal.
2. Depress the clutch pedal and shift into idling position.

3. Press the Start/Stop button.

Automatic and sport automatic transmission*

Remote control in ignition lock or with comfort access in vehicle, refer to page 40.

1. Depress brake pedal.
2. Press the Start/Stop button.

Switching off engine

 When leaving the vehicle, always take the remote control with you. When parking, firmly apply the handbrake, as otherwise the vehicle could roll. ◀

Manual transmission

1. Press the Start/Stop button with the vehicle stopped.
2. Shift into first gear or reverse.
3. Firmly apply the handbrake.
4. Remove the remote control from the ignition lock, refer to page 62.

Automatic and sport automatic transmission*

1. Shift transmission into position P with the vehicle stopped.
2. Press the Start/Stop button.
3. Firmly apply the handbrake.
4. Remove the remote control from the ignition lock, refer to page 62.

Before driving into a car wash

The vehicle can roll if you proceed according to the following steps:

1. With comfort access: insert the remote control into the ignition lock.
2. Depress brake pedal.
3. Shift into transmission position N.
4. Switch off the engine.

Transmission position P will be engaged:

- ▷ after approx. 30 seconds

- ▷ if you remove the remote control from the ignition lock

Handbrake

The handbrake is primarily intended to prevent the vehicle from rolling while parked; it brakes the rear wheels.

Indicator lamp

BRAKE The indicator lamp lights up, and a signal also sounds when starting off. The handbrake is applied.

(!) Indicator lamp for Canadian models.

Applying

The lever locks in position automatically.

Releasing

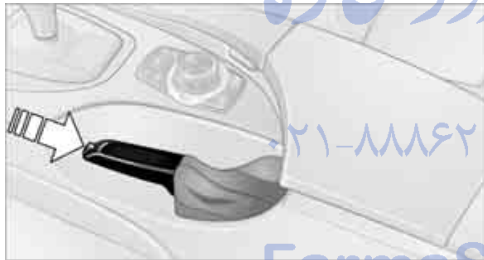

Pull slightly upwards, press the button and lower the lever.

(!) If exceptional circumstances should make it necessary to apply the handbrake while the vehicle is in motion, do not pull it too firmly. In doing so, continuously press the button of the handbrake lever. Otherwise, too firm an application of the handbrake can lock up the rear wheels and cause the rear of the car to swerve. ◀

(▷) To prevent corrosion and one-sided braking action, occasionally apply the handbrake lightly when the vehicle is slowly coming to a stop if the traffic conditions are suitable. The brake lamps do not light up when the handbrake is applied. ◀

Manual transmission



(!) While shifting in the 5th/6th gear lane, press the gearshift lever toward the right, otherwise accidental shifting into the 3rd or 4th gear could result in engine damage. ◀

Reverse gear

Select only when the vehicle is stationary. When pressing the gearshift lever to the left, overcome some resistance.

Automatic transmission with Steptronic*

In addition to fully automatic operation, you can also manually shift with the Steptronic, refer to page 65.

Transmission positions

P R N D M/S + -

Displays in instrument cluster



P R N D DS S1* to S6* M1 to M6

The transmission position is indicated, and in the manual mode, the gear currently engaged.

Engaging transmission position

- ▷ Do not leave the transmission position P until the engine is running: interlock.
- ▷ With the vehicle stationary, depress the brake pedal before shifting out of P or N; otherwise the shift command will not be executed: shiftlock.

 To prevent the vehicle from creeping after you select a driving position, maintain pressure on the brake pedal until you are ready to start. ◀

Engaging N, D, R



Briefly press the selector lever in the desired direction, beyond a resistance point if necessary. Press button **1** simultaneously out of P or into R.

The engaged transmission position is also displayed on the selector lever.

The selector lever immediately returns to the center position when released.

Engaging P



Press button **P**.

R Reverse

Select only when the vehicle is stationary.

P Park

Select only when the vehicle is stationary. The rear wheels are locked.

 P is engaged as soon as you switch off the engine unless N is engaged and with comfort access, the remote control is inserted in the ignition lock, refer to Before driving into a car wash, page 63. ◀

N Neutral

Can, for example, be engaged in automatic car washes. The vehicle can roll.

 N remains engaged even after the engine is switched off whenever you leave the remote control in the ignition lock. This function is useful, for example, in automatic car washes, refer to page 63. ◀

D Drive, automatic position

Position for normal vehicle operation. All forward gears are available.

Kick-down

Kick-down enables you to achieve maximum performance.

Press the accelerator pedal beyond the increased resistance at full throttle.

Sport program and manual mode M/S



Press the selector lever toward the left from transmission position D:
The sport program is activated, and DS is displayed in the instrument cluster; with the sport automatic transmission* also S1 to S6. This position is recommended for a performance-oriented driving style.

When the selector lever is pressed forward or back, the manual mode is activated and the Steptronic shifts the gear. The instrument cluster shows M1 through M6.

Upshifts and downshifts are only carried out at a suitable engine and vehicle speed, e.g. a downshift is not carried out at excessively high engine speeds. The selected gear is briefly displayed in the instrument cluster, followed by the current gear.

To resume automatic mode, press the selector lever to the right.

Manually unlocking and locking transmission lock

In case of a power failure, e.g. when the battery is drained or disconnected, or an electrical fault, manually release the transmission lock, as otherwise the rear wheels are blocked and the vehicle cannot be towed.

Only manually release the transmission lock for towing and firmly apply the handbrake beforehand so that the vehicle cannot roll. Reengage the transmission lock after parking the vehicle at its destination.

Unlocking

1. Reach into the trim-piece opening, arrow 1, and firmly pull the trim piece upward, arrow 2.



2. Remove the cover over the opening, refer to 3.

3. Insert a screwdriver from the onboard tool kit, refer to page 243, into the opening, arrow 1.



4. Pull the screwdriver toward the rear until it is heard to engage, arrow 2, and leave it inserted in the opening. The transmission lock is released.

Releasing on sport automatic transmission*

1. Unclip the sleeve of the selector lever.
2. Pull the sleeve over the selector lever.



3. Reach into the trim-piece opening, arrow 1, and firmly pull the trim piece upward, arrow 2.



4. Remove cover over the opening, refer to 5.

5. Insert a screwdriver from the onboard tool kit, refer to page 243, into the opening, arrow 1.



6. Pull the screwdriver toward the rear until it is heard to engage, arrow 2, and leave it inserted in the opening. The transmission lock is released.

Locking

1. Pull out the screwdriver upward. The transmission lock is locked again.



2. Reinstall the cover and the trim piece. Information on jump starting and towing from page 254.

Sport automatic transmission*

You can also shift manually with two shift paddles on the steering wheel.

You can also choose between two driving programs: Normal or Sport, refer to Dynamic Driving Control.

Shift paddles on steering wheel

The shift paddles allow you to shift gears quickly, as both hands can remain on the steering wheel.

- ▷ When you use the shift paddles on the steering wheel to shift gears in automatic mode, the gearshift system switches into the manual mode.
- ▷ If you do not shift with the shift paddles and do not accelerate for a certain time, the system switches into the automatic mode again when the selector lever is in D.

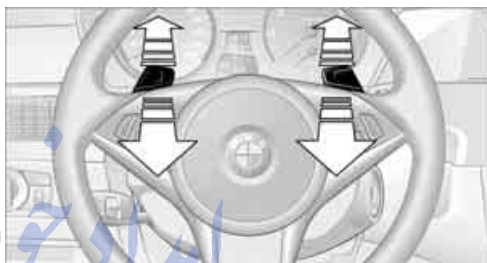

- ▷ To shift up: pull one of the shift paddles.
- ▷ To shift down: press one of the shift paddles.

Dynamic Driving Control

The Dynamic Driving Control makes it possible for your BMW to react in an even more performance-oriented manner at the push of a button:

- ▷ The speed range of the engine is optimally utilized.
- ▷ Gearshifts are faster.
- ▷ The engine responds more spontaneously to accelerator pedal movements.
- ▷ The steering will operate in an even sportier mode.
- ▷ In the automatic mode, the 6th gear is not engaged.

Activating system



Press the SPORT button. The LED in the button lights up and SPORT is displayed in the instrument cluster.

Deactivating system

- ▷ Press the SPORT button again
- ▷ Engage reverse gear
- ▷ Switch off engine

The LED in the button and SPORT in the instrument cluster go out.

Turn signals/ headlamp flasher



- 1 High beams
- 2 Headlamp flasher
- 3 Turn signals

Using turn signals

Press the lever beyond the resistance point. To turn off manually, press the lever to the resistance point.

- ▷ Atypically rapid flashing of the indicator lamp indicates that a turn signal bulb needs to be replaced. ◀

Signaling briefly

Press lever to resistance point and hold for as long as you wish to signal.

Triple turn signal activation

Press the lever to the resistance point; the turn signal flashes three times.

You can activate or deactivate this function.

iDrive, for operating principle refer to page 16.

1. Press the **MENU** button. This opens the start menu.
2. Press the controller to open the **i** menu.
3. Select "Settings" and press the controller.
4. Select "Vehicle / Tires" and press the controller.
5. Change to upper field if necessary. Turn the controller until "Lighting" is selected and press the controller.

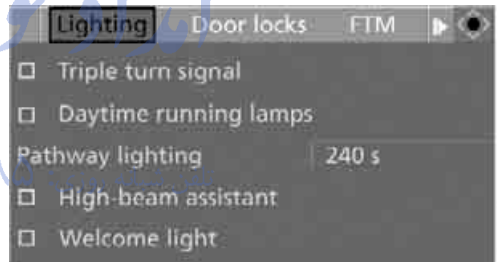

6. Select "Triple turn signal" and press the controller.

Triple turn signaling is activated.

The setting is stored for the remote control currently in use.

Wiper system

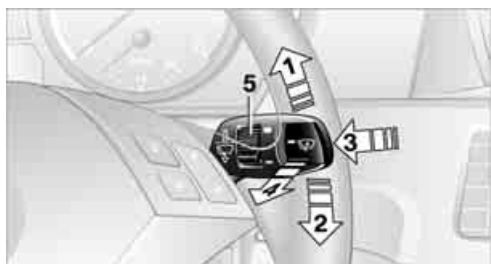

- 1 Switching on wipers
- 2 Switching off wipers or brief wipe
- 3 Activating/deactivating rain sensor
- 4 Cleaning windshield, headlamps and BMW Night Vision camera*
- 5 Adjusting rain sensor sensitivity level

Switching on wipers

Pull the lever upward, arrow 1.

The lever automatically returns to its initial position when released.

Normal wiper speed

Press once.

The system reverts to operation in the intermittent mode when the vehicle is stationary.

Fast wiper speed

Press twice or press beyond the resistance point.

The system reverts to normal speed when the vehicle is stationary.

Rain sensor

The wiper operation is controlled automatically as a function of the rain intensity. The rain sensor is located on the windshield, directly in front of the interior rearview mirror.

Activating rain sensor

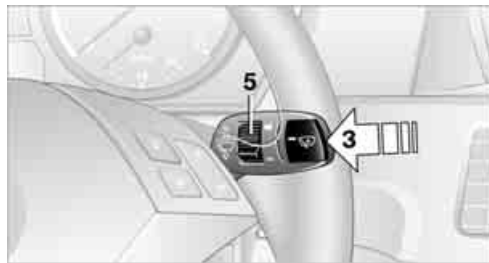

Press the button, arrow 3. The LED in the button lights up.

Adjusting rain sensor sensitivity level

Turn the knurled wheel 5.

Deactivating rain sensor

Press the button again, arrow 3. The LED goes out.



Deactivate the rain sensor when passing through an automatic car wash. Failure to do so could result in damage caused by undesired wiper operation. ◀

Cleaning windshield, headlamps* and BMW Night Vision camera*

Pull the lever, arrow 4.

The system sprays washer fluid against the windshield and activates the wipers for a brief period.

With the vehicle lighting switched on, the headlamps and the BMW Night Vision camera are also cleaned simultaneously at suitable intervals.



Do not use the washing mechanisms if there is any danger that the fluid will freeze on the windshield. If you do so, your vision could be obscured. To avoid freezing, use a washer fluid antifreeze, refer to Washer fluid. Do not use washing mechanisms when the washer fluid reservoir is empty, otherwise you will damage the washer pump. ◀

Windshield washer nozzles

The windshield washer nozzles are heated when the engine is running or the ignition is switched on.

Sports Wagon: Rear window wiper



- 1 Intermittent mode. When reverse gear is engaged, continuous operation is switched on automatically
- 2 Cleaning the rear window

 Do not use washing mechanisms when the washer fluid reservoir is empty, otherwise you will damage the washer pump. ◀

Washer fluid

 Washer fluid antifreeze is flammable. For this reason, keep it away from ignition sources and store only in the closed original container out of reach of children. Otherwise, there is the danger of bodily injury. Always observe the instructions for use provided on the containers. ◀

Filler neck for washer fluid

 Only add washer fluid with the engine cooled down to exclude contact with hot engine components. Otherwise there is a danger of fire and to personal safety if the fluid is spilled. ◀



All washer nozzles are supplied from one reservoir.

Fill with water and – if required – with a washer antifreeze, according to manufacturer's recommendations.

 In order to maintain the mixture ratio, mix the washer fluid before filling. ◀

Capacity

Sedan:

Approx. 3.2 US quarts/3 liters, with headlamp washer system* approx. 5.3 US quarts/5 liters.

Sports Wagon: approx. 5.3 US quarts/5 liters.

Cruise control*

The concept

The cruise control is available for use at speeds of approx. 20 mph/30 km/h and higher. The vehicle stores and maintains the speed that you set using the lever mounted on the steering column. To maintain the specified speed, the system brakes if the engine braking effect is not sufficient on a downhill grade. Speed can drop on uphill grades if the engine output is insufficient.

 Do not use the cruise control under driving conditions that do not permit a constant speed, e.g. when driving on winding roads, in heavy traffic or in poor road conditions such as snow, rain, ice, loose road surface, and poor visibility. Otherwise you could lose control of the vehicle and cause an accident. ◀

One lever for all functions

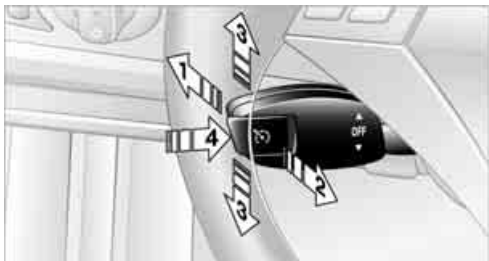

- 1 Maintaining, storing and increasing speed
- 2 Maintaining speed, storing speed, and decelerating
- 3 Interrupting and deactivating system
- 4 Resuming stored speed

Maintaining, storing and increasing speed

Press lever to resistance point, arrow **1**:
The speed currently being driven is maintained and stored. The display **1** in the speedometer, see below, indicates this regulated speed. Every time you press the lever, the vehicle's speed increases by roughly 1 mph/1 km/h.

Press lever to resistance point for a longer time:
The vehicle accelerates without pressure on the accelerator pedal. The system maintains and stores your current speed as soon as you release the lever.

Press the lever beyond the resistance point:
The speed is increased to the next fives position in the mph display or the next tens position in the km/h display.

Press and hold the lever beyond the resistance point:
The vehicle accelerates more quickly.

Maintaining speed, storing speed, and decelerating

Pull the lever, arrow **2**:
Functions are the same as **1**; the speed is reduced.

Interrupting system

Press the lever up or down, arrow **3**: the display **1** in the speedometer changes color.

In addition, the system is interrupted:

- ▷ when you apply the brakes, even with the handbrake
- ▷ when you shift very slowly, when you shift the manual transmission into idling mode, or when you shift the automatic transmission into the N position
- ▷ when DTC is activated or DSC is deactivated
- ▷ when the DSC comes on

Resuming stored speed

Press button **4**:

The stored speed is resumed and maintained.

Deactivating system

- ▷ Press the lever up or down twice, arrow **3**
- ▷ Switch off the ignition

The speed stored in the memory is deleted.

Displays in instrument cluster



- 1 Stored speed
- 2 Selected speed is displayed briefly

Active cruise control*

With active cruise control you can select a desired speed which is then automatically maintained when driving on open roadways and is varied to maintain a selected distance setting to slower moving vehicles ahead.

Active cruise control represents a technological advance over the familiar cruise control and is a welcome relief from the constant adjustment of speed that can accompany driving in traffic on freeways or other high-speed thoroughfares. Especially on longer trips and in traffic congestion, the system can reduce fatigue and tension, while increasing your enjoyment of driving. Please use it safely and responsibly.

In addition to holding a steady cruising speed, if you encounter slower vehicles ahead, active cruise control will, within limits, adjust your vehicle's speed automatically so that you can flow with the traffic without having to make constant adjustments. If, for example, while cruising at the selected speed, you begin to approach a slower vehicle ahead of you in the same lane, the system will reduce your vehicle's speed to the same as that of the vehicle ahead to maintain your selected distance setting. You can vary the following distance, which will vary with speed. Based on your selected distance setting, the system automatically decreases the throttle setting and lightly applies the brakes if necessary. In addition, if the vehicle ahead of you slows to a complete stop, the system can follow this action within the given scope and can also accelerate from a complete stop if the vehicle ahead of you drives off again shortly thereafter. During braking, your vehicle brake lamps will automatically illuminate to alert a following driver to take action. In addition, it may be necessary for your vehicle to downshift the automatic transmission to maintain the distance setting selected. As soon as the road in front of you has no moving vehicles, the system will accelerate to your desired speed. This set speed is also maintained on downhill grades, however the vehicle speed can drop below the set speed when driving uphill if the engine output is not sufficient.

 Active cruise control cannot detect stop signs, red lights, or any object that is stopped or is blocking the road.

Active cruise control is not and must not be used as a collision avoidance/warning system. Since this active cruise control system is a new technology and operates differently from con-

ventional cruise control systems which you may be accustomed to, it is necessary that you read all of the pages relating to this system before use. Carefully read and observe the information on the system limitations beginning on page 76 to obtain a good command of the system and its range of applications. ◀

Brake pedal feel

When the system brakes and you also depress the brake pedal, a somewhat different braking feel results.

Professional* navigation system

If a navigation DVD is in the drive, refer to page 142, within limits the system adjusts the accelerating and braking behavior of the vehicle to the road you are driving on.

 To ensure that the system is informed of the current course of the road, always use the latest navigation DVD if possible. ◀

When the vehicle position is unknown, e.g. when you leave the map area, this influence of the navigation system is not available.

Applications

Please try the system first during sparse traffic and clear road conditions so that you can get used to the system. After you have experience and understand the system, only then use it during normal traffic.

As with conventional cruise control systems, active cruise control in no way reduces or substitutes for the driver's own personal experience, responsibility, alertness and awareness in adjusting speed, braking or otherwise controlling the vehicle. The driver should decide when to use the system on the basis of road, traffic, visibility, and weather conditions. Active cruise control is intended for use on highway-type roadways where traffic is moving relatively smoothly as well as in slow-moving traffic. Do not use the system in city driving; in complex driving situations; heavy traffic such as during rush hour; on curvy, winding roads, slippery roads or roads with sharp curves such as highway off-ramps; during inclement weather such

as snow, strong rain or fog; or when entering interchanges, service/parking areas or toll booths. It is also important to regulate your vehicle's speed and distance setting within applicable legal limits. Always be ready to take action or apply the brakes if necessary, especially when the system is actively following a vehicle in front of you. Otherwise, driving conditions can result which lead to a violation of the law or elevated risk of an accident.

The minimum initial activation speed is 20 mph/30 km/h, and the maximum speed is 110 mph/180 km/h. However, you can also activate the system while stopped, refer to *While stopped*, page 74.

One lever for all functions

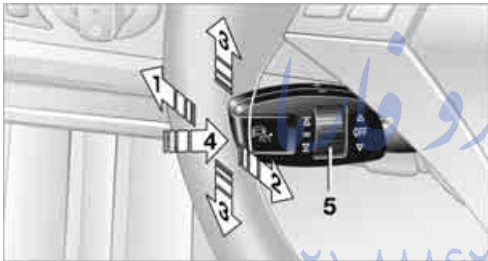

- 1 Storing and increasing desired speed
- 2 Storing and reducing desired speed
- 3 Interrupting, refer to page 74, or deactivating system, refer to page 75
- 4 Activating stored desired speed and distance, refer to page 74, or driving off, refer to *While stopped*, page 74
- 5 Selecting distance to vehicle driving ahead, refer to page 73

Storing current speed

Tap the lever, arrow 1, or briefly pull it, arrow 2.



The system stores the current vehicle speed. It is indicated on the speedometer and briefly in the instrument cluster.

Increasing desired speed

Press or tap the lever to the resistance point or beyond, arrow 1, until the desired speed is displayed.

The speed then displayed is stored and achieved on a clear road.

- ▶ Each time the lever is tapped to the resistance point, the desired speed is increased by approx. 1 mph/1 km/h.
- ▶ Each time the lever is tapped beyond the resistance point, the desired speed increases to the next five position in the mph speedometer display or the next tens position in the km/h speedometer display.

Reducing desired speed

Pull the lever, arrow 2, until the desired speed is displayed.

These functions are operated in the same manner as increasing your desired speed.

Selecting distance



- ▶ Briefly press rocker switch downward: Increase distance.

- ▷ Briefly press rocker switch upward:
Reduce distance.

The selected distance is displayed in the instrument cluster.



Distance 1, closest



Distance 2



Distance 3



Distance 4, farthest
This distance is set when you activate the system.

- ⚠ Use good judgment to select the appropriate following distance, given road conditions, traffic, applicable laws and State driving recommendations for safe following distance. Otherwise, a violation of the law or risk of an accident could result. ◀

Interrupting cruise control

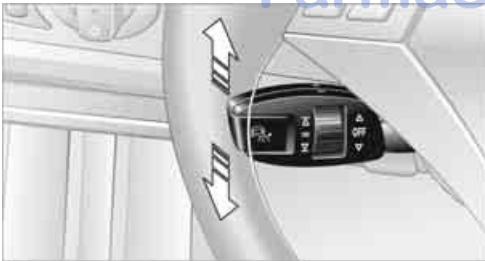

Press the lever upward or downward, and with the vehicle stopped also depress the brake pedal. The marking in the speedometer changes color and the distance indicator goes out.

In addition, the system is automatically interrupted:

- ▷ when you apply the vehicle brakes
- ▷ when you shift the transmission
- ▷ when DTC is activated or DSC is deactivated
- ▷ when DSC comes on
- ▷ when you apply the handbrake
- ▷ when you release the safety belt and open the driver's door with the vehicle stopped
- ▷ when the system does not recognize any objects for an extended period of time, e.g. on infrequently traveled roads without a shoulder or guard rails, or if the radar sensor is covered with dirt, refer to page 75

- ⚠ If the system is interrupted, then it is necessary for the driver to actively intervene by braking and steering. Otherwise, there is a risk of an accident. ◀

Resuming stored desired speed and distance

While driving

Press button 4.

The displays appear in the instrument cluster.

While stopped

- ⚠ Before leaving the vehicle with the engine running, engage position P of the automatic transmission and apply the handbrake. Otherwise the vehicle can roll. ◀

If a detected vehicle in front of you brakes to a complete stop and your vehicle has also been braked to a complete stop by the system:

- ▷ If the vehicle in front of you drives off while the marking 1 for the desired speed in the speedometer is green, your vehicle will accelerate without you having to do anything.
- ▷ If the vehicle in front of you drives off while the marking 1 is orange, you briefly depress the accelerator pedal or press button 4. Rolling bars in the distance indicator 3 mean that the vehicle in front of you has driven off.

If you are stopped behind a vehicle with the brake pedal depressed and the system is interrupted or deactivated:

1. Press button **4** to activate a stored desired speed or select a desired speed with the lever, arrow **1** or arrow **2**.
2. Release the brake pedal.
3. If the vehicle in front of you drives off, briefly depress the accelerator pedal or press button **4**.

Deactivating system

- ▷ Press the lever upward or downward twice while driving.
- ▷ When stopped, do the same with the brake pedal depressed.
- ▷ Switch off the ignition.

The displays turn off, and the stored desired speed and distance are deleted.

Displays in instrument cluster



- 1 Stored desired speed
 - ▷ Green: the system is active.
 - ▷ Orange: the system is interrupted.
- 2 Lights up yellow: vehicle detected ahead
Display also used for warnings, please read all information on warnings
- 3 Selected distance to vehicle ahead
The indicator lights up as soon as the system is activated
The bars roll: the vehicle in front of you has driven off
- 4 Brief display of stored desired speed

 If the display --- mph/--- km/h appears briefly, the conditions necessary for operation may currently not be met. ◀

Warning lamps



The indicator **2** continuously flashes yellow.

The prerequisites for operating the system are no longer met, e.g. as a result of ABS or DSC interventions. The system brakes until you actively take over.



The indicator **2** flashes red; a signal sounds.

The system indicates that you must brake and/or maneuver the vehicle yourself. The system cannot automatically restore the distance to the vehicle driving ahead. However, this display cannot relieve the driver of the responsibility for adjusting the desired speed and driving style to the traffic conditions.

Radar sensors



- 1 Long-range sensor
- 2 Location of the short-range sensors behind the bumper
- 3 Location of the short-range sensors behind the bumper with the M sports package*

Heavy rain and also dirt, snow or ice can limit the detection of vehicles ahead. If needed, clean the radar sensor under the front bumper as well as the bumper area covering the short range sensors. When doing so, be particularly careful in removing layers of snow and ice.

Do not apply adhesive labels etc. in the area of the short-range sensors.

If the sensor is not aligned properly, e.g. due to damage, the active cruise control cannot be activated.

System limitations

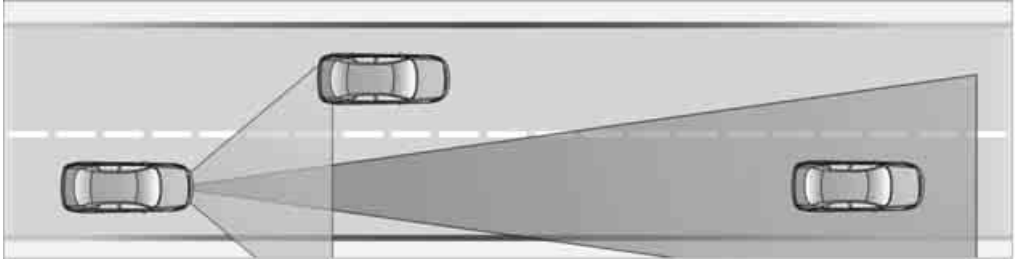

! As with conventional cruise control systems, active cruise control in no way diminishes or substitutes for the driver's own personal responsibility, alertness and awareness in adjusting speed, braking or otherwise controlling the vehicle. The driver should decide when to use the system on the basis of road, traffic, visibility, and weather conditions. Active cruise control is intended for use on highway-type roadways where traffic is moving relatively smoothly. Do not use this system in city driving; in complex driving situations; on curvy, winding roads, slippery roads or roads with sharp curves such as highway off-ramps; during inclement weather such as snow, strong rain or fog; or when entering interchanges, service/parking areas or toll booths. It is also important to regulate your vehicle's speed and distance setting within applicable legal limits. Always be ready to take action or apply the brakes if necessary, especially when the system is actively following a vehicle in front of you. ◀

! Always remember that the range and ability of the system do have physical limitations. For example, the system may not detect vehicles driving ahead if they suddenly brake heavily in stop-and-go traffic during acceleration. The system will not apply the brakes or slow your vehicle when a very slow-moving vehicle, stopped vehicle or stationary object is in the lane ahead of you, for example when approaching a traffic light or parked vehicle or when a vehicle is stalled in your lane. Also, the

system does not react to oncoming traffic, pedestrians or other types of potential traffic such as a rider on a horseback. It is also possible that the system may not detect smaller moving objects such as motorcycles or bicycles. Be especially alert when encountering any of these situations as the system will neither automatically brake, nor provide a warning to you. Also, be aware that every decrease in the distance setting allows your vehicle to come closer to a vehicle in front of you and requires a heightened amount of alertness. ◀

The system cannot allow the vehicle to drive off automatically in situations that make driving off considerably more difficult, e.g. on steep uphill grades, with a heavy trailer or before raised areas in the road.

Near radio astronomy stations, the system radar is deactivated at speeds under 20 mph/ 30 km/h due to legal regulations.

! Be certain to interrupt the system when you pull into an exit lane for a highway offramp. ◀

Also, vehicles traveling in a staggered manner on a highway may cause a delay in the system's reaction to a vehicle in front of you or may cause the system to react to a vehicle that is actually in the lane next to yours. Always be ready to take action or apply the brakes if necessary.

! In addition, the system is interrupted whenever the driver applies the vehicle brakes, shifts the transmission from drive/D to

neutral/N, or deactivates DSC. After any interruption, the system will no longer automatically activate the vehicle brakes, which means the driver must intervene and resume manual braking. You should then reactivate the system only when you are fully aware of the prior speed and distance settings. ◀

Active cruise control may brake when you reduce the stored desired speed; however, the driver must constantly monitor traffic and intervene if necessary.

When you switch off the engine or ignition, active cruise control is fully switched off, too, and any settings you have selected are canceled.

Unexpected lane change

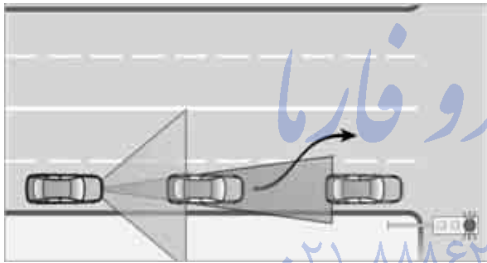

If a vehicle in front of you is behind a stopped vehicle and unexpectedly changes lanes, you must react yourself, as the system does not react to stopped vehicles.

Swerving vehicles

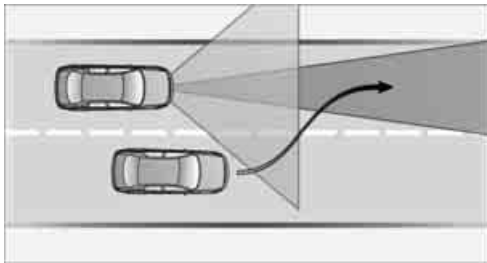

When a vehicle swerves out of adjacent lanes into your lane, the system does not detect the vehicle until it is completely in your lane.

 When a vehicle ahead suddenly swerves into your lane, the system may not be able

to restore the selected distance automatically. This also applies to great differences in speed between your vehicle and vehicles ahead, e.g. when quickly approaching a truck. Once the system has established that a vehicle is indeed in front of you, it will indicate that you must brake and/or maneuver the vehicle yourself. Take action yourself, otherwise there is a risk of an accident. ◀

Behavior in curves

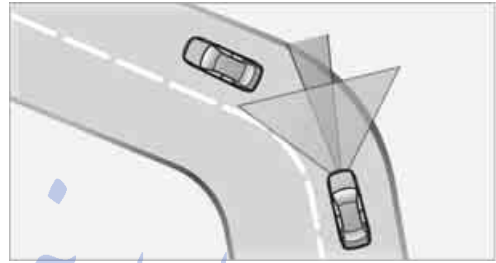

If the selected desired speed for a curve is too high, the system reduces the speed within a curve. However, it cannot detect curves in advance. Therefore, select a suitable speed at the start of a curve.

Because of the limited range of the system, it is possible that in curves or on the peaks and valleys of hilly roads, a vehicle ahead may be recognized late, or not at all. Therefore, it is up to the driver to select a speed that is prudent in view of the curves and terrain of the roadway.

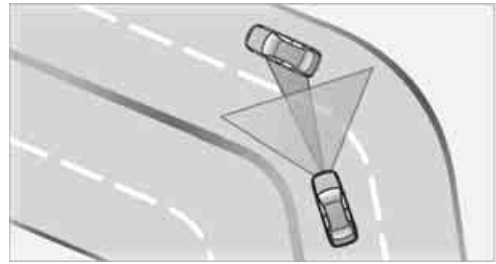

In approaching a curve, it is possible that active cruise control might react briefly to a vehicle in the adjacent lane. In addition, the system can sense if your vehicle is in a curve and may not accelerate. If your vehicle decelerates in either

case, you can choose to overcome the deceleration by briefly pressing the accelerator pedal.

Driver interventions and your responsibility

 Anytime the driver presses down on the accelerator pedal, any braking action by the system is interrupted and the distance indicator goes out until the pedal is fully released. As soon as you fully release the accelerator, the system will again control your cruising speed and distance setting. While driving with the system activated, resting your foot on the accelerator pedal will cause the system not to brake even when necessary. Be certain that floor mats or other objects on the vehicle floor do not interfere with movement of the accelerator pedal. ◀

 While active cruise control is capable of braking your vehicle automatically when you approach a slower vehicle ahead, it is important to be aware that the ability of the system to apply the brakes is also limited, e.g. when you reduce your desired speed sharply. It uses only a portion of braking system capacity and does not utilize the full capacity of the vehicle braking system. Therefore, the system cannot decrease your speed due to large differences in speed between your vehicle and the vehicle ahead. Example: when you approach a vehicle traveling at a much lower speed than your own speed such as approaching a toll booth or when a much slower vehicle cuts in front of you at close range. ◀

Everything under control

Odometer, outside temperature display, clock, date



- 1 Time, outside temperature and date
- 2 Odometer and trip odometer
- 3 Press button:
 - ▶ with ignition switched on, trip odometer is reset
 - ▶ with ignition switched off, time, outside temperature, and odometer are briefly displayed.

From radio readiness the outside temperature and the time are displayed.

Date retrieval:

Press CHECK button on turn signal lever, refer to page 85.

Time and date setting, refer to page 87.

You can set the unit of measure °F or °C on the Control Display, refer to Units of measure on page 89.

Outside temperature warning

If the display drops to +37 °F / +3 °C, a signal sounds and a warning lamp lights up. A message appears on the Control Display. There is an increased danger of ice.

 Even at temperatures above +37 °F / +3 °C ice can form. Therefore, drive carefully, e.g. on bridges and sections of road in the shade, otherwise there is an increased accident risk. ◀

Tachometer



Avoid engine speeds in the white-striped advance warning field, arrow 1, if possible.

Be sure to avoid engine speeds in the red warning field, arrow 2. At high revs in this range, the flow of fuel is interrupted to protect the engine.

Coolant temperature

Should the coolant, and with it the engine become too hot, a warning lamp lights up. In addition, a message appears on the Control Display.

Checking coolant level, refer to page 235.

Energy Control



Displays the current fuel consumption. This allows you to see whether your current driving style is conducive to fuel economy with minimum exhaust emissions.

Fuel gauge



Fuel tank capacity: approx. 18.5 US gal/ 70 liters, including the reserve capacity of approx. 2.1 US gal/8 liters.

550i: approx. 2.6 US gal/10 liters reserve capacity.

You will find information on refueling on page 220.

If the tilt of the vehicle varies for a longer period, when you are driving in mountainous areas, for example, the indicator may fluctuate slightly.

Reserve

After the reserve quantity has been reached, a message briefly appears on the Control Display; the remaining range is shown in the computer. Below a range of approx. 30 miles/50 km, the message remains on the Control Display.

 Refuel as soon as possible once your cruising range falls below 30 miles/

50 km, otherwise engine functions are not ensured and damage can occur. ◀

Computer

Displays in instrument cluster



Press the button on the turn signal lever.

The following information is displayed in the specified order:

- ▶ Cruising range
- ▶ Average speed
- ▶ Average fuel consumption
- ▶ No information

Cruising range

Displays the estimated cruising range available with the remaining fuel. The range is projected based on the driving style over the last 20 miles/ 30 km.

 Refuel as soon as possible once your cruising range falls below 30 miles/ 50 km, otherwise engine functions are not ensured and damage can occur. ◀

Average speed

Periods with the vehicle parked and the engine switched off are not included in the calculations of average speed.

To reset average speed: press BC button on turn signal lever for approx. 2 seconds.

Average fuel consumption

The average fuel consumption is calculated for the time during which the engine is running.

To reset average fuel consumption: press BC button on turn signal lever for approx. 2 seconds.

For different routes

You can display the average speed and average consumption for two different routes on the Control Display, refer to the following and to Trip computer*.

Displays on Control Display

You can also call up the computer via iDrive. For operating principle refer to page 16.

1. Press the **MENU** button.
This opens the start menu.
2. Move the controller to the right to open "Navigation".
Without navigation system*:
Open "Car Data".
3. Select "Car Data" and press the controller.

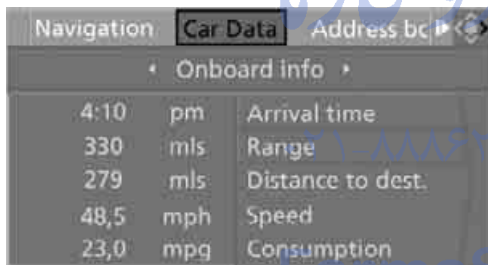

4. Select "Onboard info" and press the controller.

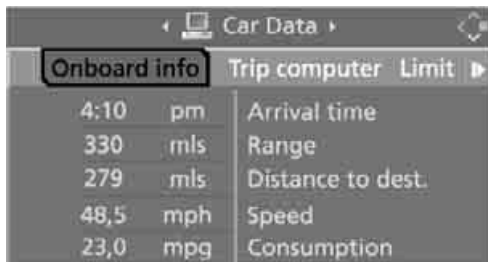

- ▷ Estimated time of arrival at destination and remaining distance:
 - ▷ Entering a distance manually in the computer, see below.
 - ▷ Entering a destination in the navigation system*, refer to page 144.
- ▷ Cruising range
- ▷ Average speed
- ▷ Average fuel consumption

Resetting values

You can reset the values for the average speed and average fuel consumption:

1. Select the respective menu item and press the controller.
2. To confirm your selection, press the controller again.

Entering a distance manually

1. Select "Distance to dest." and press the controller.

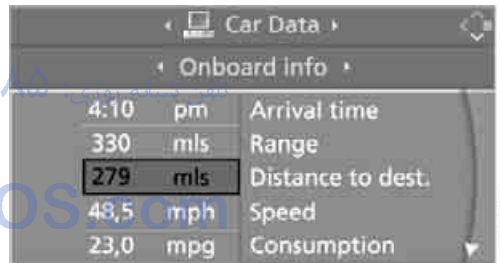

2. Turn the controller to select the distance to your destination.
3. Press the controller to apply the setting.

The distance is automatically preset during the destination guidance of the navigation system*.

Trip computer*

The trip computer is suitable, for example, for a vacation trip.

1. Open the start menu.
2. Open "Navigation".
Without navigation system*:
Open "Car Data".

3. Select "Car Data" and press the controller.
4. Select "Trip computer" and press the controller.

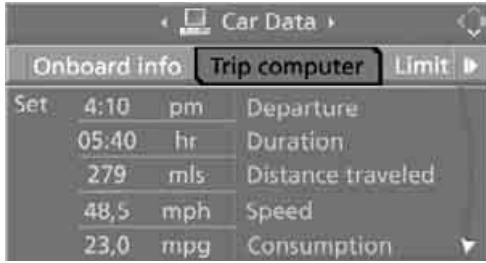

- ▷ Departure time
- ▷ Driving time
- ▷ Distance traveled
- ▷ Average speed
- ▷ Average fuel consumption

Starting or stopping the trip computer, or resetting all values:

1. Select "Set" and press the controller.
2. Select the desired menu item.
3. Press the controller.

Display options

You can display the computer or the trip computer in the assistance window.

1. Move the controller to the right to change to the assistance window and press the controller.



2. Select "Onboard info" or "Trip computer".

3. Press the controller.



Service requirements



The remaining driving distance and the date for the next maintenance are displayed briefly with the ignition switched on.

- ▷ Your BMW Service Advisor can determine your vehicle's current service requirements by reading out the data stored in the remote control. ◀

Additional information

You can select a display of more detailed information on the maintenance scope on the Control Display. For operating principle refer to page 16.

1. Open the start menu.
2. Press the controller to open the **i** menu.
3. Select "Info sources" and press the controller.
4. Select "Service Info" and press the controller.

- Change to upper field if necessary. Turn the controller until "Service requirements" is selected and press the controller.

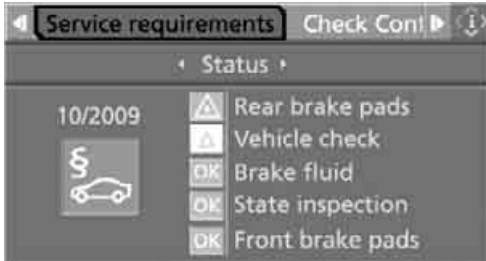

- Select "Status" and press the controller.

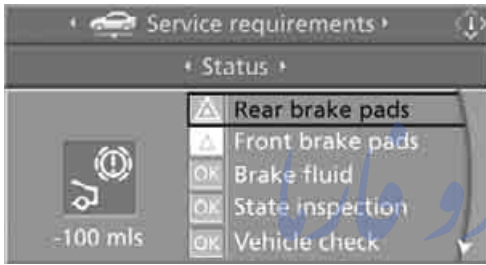

The display shows a list of selected service and maintenance procedures, as well as legally mandated inspections.

You can request more detailed information on every entry:

Select the entry and press the controller.

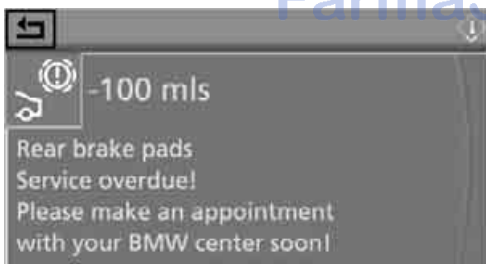



To exit the menu:

- Select the arrow and press the controller.

Symbols

 No service is currently required.

 The deadline for service or a legally mandated inspection is approaching. Please arrange a service appointment.

 The service deadline has already passed.

Entering deadlines for legally required inspections*

Make sure the date on the Control Display is set correctly, refer to page 87, otherwise the effectiveness of CBS Condition Based Service is not ensured.

- Open the start menu.
- Press the controller to open the **i** menu.
- Select "Info sources" and press the controller.
- Select "Service Info" and press the controller.
- Change to upper field if necessary. Turn the controller until "Service requirements" is selected and press the controller.
- Select "Status" and press the controller.
- Select "State inspection" and press the controller.
- Select "Set service date" and press the controller. The month is selected.

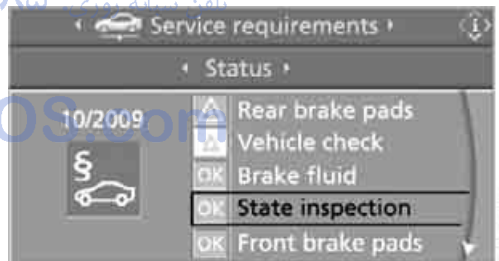

9. Turn the controller to make the adjustment.



10. Press the controller to apply the setting.
The year is selected.

11. Turn the controller to make the adjustment.

12. Press the controller to apply the setting.
The date entry is stored.

To exit the menu:

↩ Select the arrow and press the controller.

Check Control

The concept

The Check Control monitors functions in the vehicle and issues a message if there is a malfunction in the monitored systems. This kind of Check Control message consists of indicator and warning lamps in the instrument cluster, and if necessary an acoustic signal and text messages at the bottom of the Control Display.

Indicator and warning lamps



The indicator and warning lamps can light up in different combinations and colors.



▲ means that a Check Control message has been generated. The symbol continues to be visible even when the Check Control message disappears after a short time. The warning lamps and text messages are stored and can be displayed later, also refer to page 85.

Explanatory text messages



Text message at the bottom edge of the Control Display explain the meaning of the displayed indicator and warning lamps.

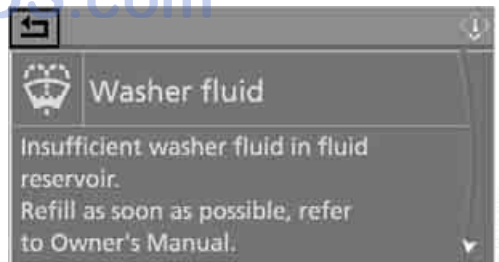

For most Check Control messages, you can view more information later, e.g. regarding the cause of a malfunction and how to respond; refer to the information provided below.

In urgent cases, this information will be shown as soon as the corresponding lamp lights up.

Exit the displayed information:
Select the arrow and press the controller.

Hiding Check Control messages

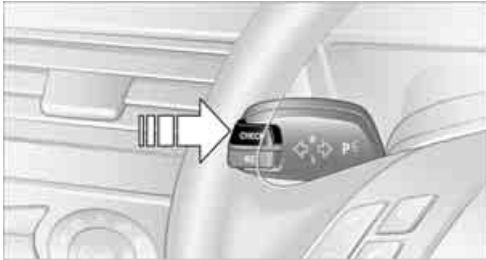

Press the CHECK button on turn signal lever. Some Check Control messages are displayed until the malfunctions have been rectified. They cannot be hidden. If a number of malfunctions occur simultaneously, they are displayed in succession.

Other messages are hidden after approx. 20 seconds, but remain stored.

Displaying stored Check Control messages

1. Press the button longer:
The first stored message is displayed.

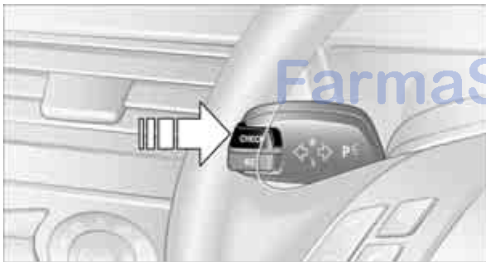

2. Press the button:
When the button is pressed again, a different message is displayed.

Displaying additional information later

iDrive, for operating principle refer to page 16.

1. Press the **MENU** button.
This opens the start menu.
2. Press the controller to open the **i** menu.

3. Turn the controller until "Info sources" is selected and press the controller.



4. Turn the controller until "Service Info" is selected and press the controller.
5. Change to upper field if necessary. Turn the controller until "Check Control messages" is selected and press the controller.

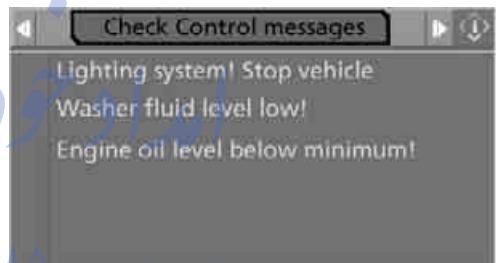

6. Select a text message and press the controller.

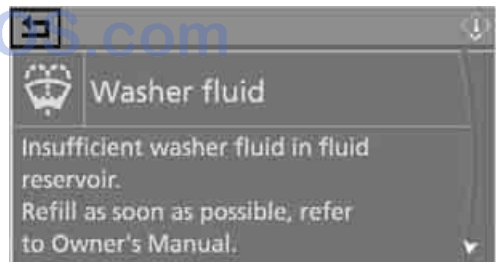

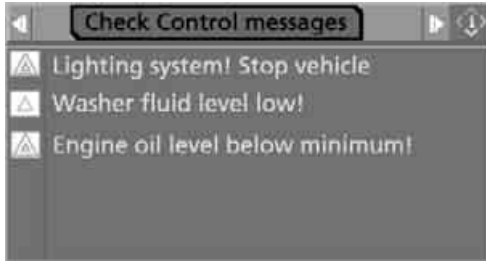

To exit the display:
Select the arrow and press the controller.

Indication of malfunction urgency



Depending on your vehicle's equipment, the stored Check Control messages are also displayed with the following symbols:

-  No malfunctions are present in the monitored systems.
-  Malfunctions are present in the monitored systems. Depending on the malfunction, supplementary information is shown on the Control Display.
-  Malfunctions are present in the monitored systems. Depending on the malfunction, supplementary information is shown on the Control Display.

The symbols also indicate the status of the service requirements display, refer to page 82.

Displays after completion of trip

Malfunction reports generated during the trip are shown consecutively when you switch off the ignition.

Before the display disappears, you can display the messages once again. Press the CHECK button for approx. 2 seconds. If several messages are present, you can continue to press the CHECK button to view them in succession.

The display goes out

- ▷ after a short time
- ▷ when you press the CHECK button again for approx. 2 seconds

Speed limit

You can enter a speed and a Check Control message indicates when you have reached this speed. This enables you, for example, to receive warnings if you exceed a speed limit in an urban area.

You are only warned of reaching this speed a

second time if your vehicle speed falls below it again by at least 3 mph/5 km/h.

Displaying, setting or changing limit

iDrive, for operating principle refer to page 16.

1. Open the start menu.
2. Open "Navigation".
Without navigation system*:
Open "Car Data".
3. Select "Car Data" and press the controller.
4. Select "Limit" and press the controller.



5. Select the speed value and press the controller.
6. Turn the controller to set the limit.
7. Press the controller to apply the setting.
The limit is activated.

Applying your current speed as limit

Select "Select current speed" and press the controller. The system adopts your current speed as the limit.

Activating/deactivating the limit

Select "On" and press the controller.

The limit is activated.

Stopwatch

iDrive, for operating principle refer to page 16.

1. Open the start menu.
2. Open "Navigation".
Without navigation system*:
Open "Car Data".
3. Select "Car Data" and press the controller.

4. Select "Stopwatch" and press the controller.



Starting, stopping or resetting

- ▷ Select "Start" and press the controller. The stopwatch starts at the displayed time.
- ▷ Select "Reset" and press the controller. The stopwatch is reset and it restarts if it was running beforehand.
- ▷ Select "Stop" and press the controller. This stops the timer.

Taking an intermediate time reading

Select "Interim time" and press the controller. The interim time appears below the ongoing primary stopwatch count.

- ▷ All of the other functions remain available even while the stopwatch is running. The stopwatch continues operation in the background. ◀

Settings on Control Display

iDrive, for operating principle refer to page 16.

1. Press the **MENU** button once or twice until the start menu appears.



2. Press the controller to open the **i** menu.

3. Turn the controller until "Settings" is selected and press the controller.



Setting time

1. Turn the controller until "Time / Date" is selected and press the controller.



2. Move the controller once to the front if necessary to change to the first field from the top.

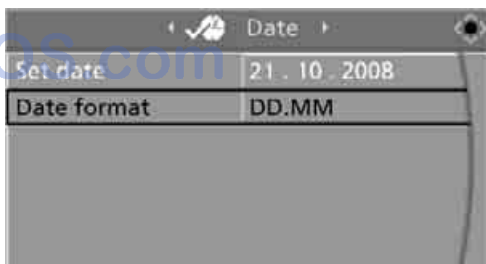

3. Turn the controller until "Time" is selected and press the controller.

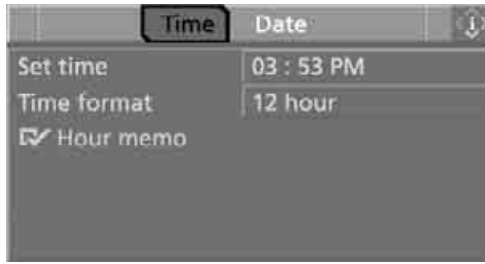

4. Turn the controller until "Set time" is selected and press the controller.

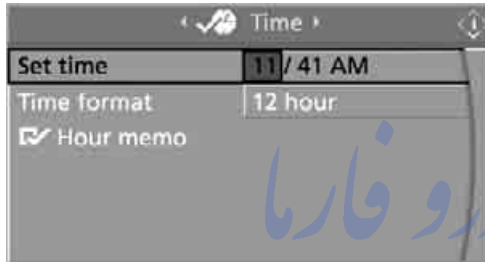

Creating settings

1. Turn the controller to set the hours and press the controller.
2. Turn the controller to set the minutes and press the controller.

The changed time is stored.

Switching on hour signal*

You will hear three tones just before the top of each hour.

Select "Hour memo" and press the controller.

The hour signal is activated.

The setting is stored for the remote control currently in use.

Setting 12h/24h format

1. Select "Time format" and press the controller.
2. Select the desired format and press the controller.

The setting is stored for the remote control currently in use.

Setting date

1. Select "Date" and press the controller.



2. Select "Set date" and press the controller. The first setting of the date display is selected.
3. Turn the controller to make the adjustment.
4. Press the controller to apply the setting. The next setting is selected.
5. Make the remaining adjustments. After the last adjustment, the date is stored.

Setting date format

1. Select "Date format" and press the controller.
2. Select the desired format and press the controller.

The setting is stored for the remote control currently in use.

Brightness of Control Display

The brightness is automatically adapted to the ambient lighting conditions. However, you can change the basic setting.

iDrive, for operating principle refer to page 16.

1. Press the **MENU** button. This opens the start menu.
2. Press the controller to open the **i** menu.
3. Select "Settings" and press the controller.
4. Select "Display settings" and press the controller.

5. Change to upper field if necessary. Turn the controller until "Brightness" is selected and press the controller.

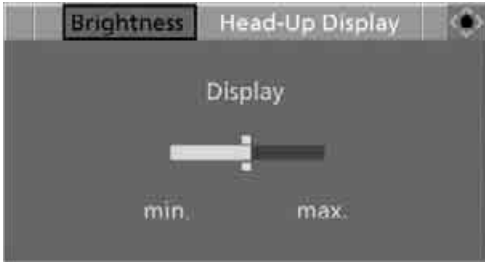

6. If necessary, move the controller to the right to select "Display".
7. Turn the controller until the desired setting is selected.

The setting is stored for the remote control currently in use.

Units of measure

You can change the units of measure for consumption, distances, temperature and pressure.

iDrive, for operating principle refer to page 16.

1. Press the **MENU** button. This opens the start menu.
2. Press the controller to open the **i** menu.
3. Select "Settings" and press the controller.
4. Select "Language / Units" and press the controller.
5. Change to upper field if necessary. Turn the controller until "Units" is selected and press the controller.

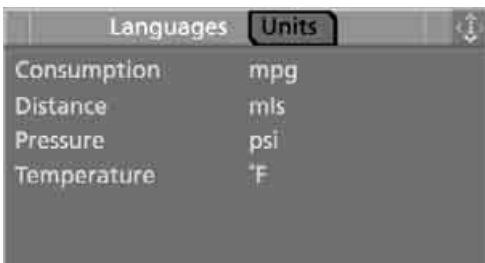

6. Select the menu item to be set and press the controller.

7. Select the desired unit of measure and press the controller.

The settings are stored for the remote key currently in use.

Language on Control Display

You can change the language of the text displays.

iDrive, for operating principle refer to page 16.

1. Press the **MENU** button. This opens the start menu.
2. Press the controller to open the **i** menu.
3. Select "Settings" and press the controller.
4. Select "Language / Units" and press the controller.
5. Change to upper field if necessary. Turn the controller until "Languages" is selected and press the controller.

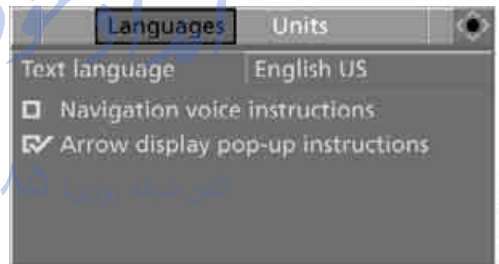

6. Select "Text language" and press the controller.
7. Select and activate the desired language by pressing the controller.

The setting is stored for the remote control currently in use.

Technology for comfort, convenience and safety

PDC Park Distance Control*

The concept

The PDC assists you when you are parking. Acoustic signals and an optical display* alert you to the approach of an object from behind your vehicle. To measure the distance, there are four ultrasonic sensors in each bumper. The range of these sensors is approx. 7 ft/2 m. However, an acoustic warning first sounds for the sensors at the front and at the two rear corners at approx. 24 in/60 cm, and for the center rear sensors at approx. 5 ft/1.50 m.

 PDC is a parking aid that can indicate objects when they are approached slowly, as is usually the case when parking. Avoid approaching an object at high speed, otherwise the physical circumstances would mean that the system warning was too late. ◀

Automatic activation

The system starts to operate approx. one second after you shift into reverse or move the selector lever into position R with the engine running or the ignition switched on.

Wait this short time before driving off.

Manual activation



Press the button; the LED lights up.

Manual deactivation

Press the button again; the LED goes out.

Automatic deactivation

After driving approx. 165 ft/50 m or at over approx. 20 mph/30 km/h, the system is switched off and the LED goes out. You can reactivate the system manually as needed.

Signal tones

When nearing an object, the position is correspondingly indicated by an interval tone. Thus, an object detected to the left rear of the vehicle will be indicated by a signal tone from the left rear speaker, etc. As the distance between vehicle and object decreases, the intervals between the tones become shorter. If the distance to the nearest object falls to below roughly 1 ft/30 cm, then a continuous tone sounds.

An intermittent tone is interrupted after approx. 3 seconds:

- ▷ if you remain in front of an object that was only detected by one of the corner sensors
- ▷ if you drive parallel to a wall

Malfunction

The LED in the button flashes and a message appears on the Control Display. PDC is malfunctioning. Have the system checked.

To prevent this problem, keep the sensors clean and free of ice or snow in order to ensure that they will continue to operate effectively. Do not spray the sensors with high-pressure cleaning jets for long periods and maintain a distance of at least 4 in/10 cm to them.

PDC with visual warning*

You can also have the system show distances to objects on the Control Display. Objects that are farther away are already shown there before a signal tone sounds. The setting is stored for the remote control currently in use.

iDrive, for operating principle refer to page 16.

1. Press the **MENU** button.
This opens the start menu.
2. Press the controller to open the **i** menu.



3. Turn the controller until "Settings" is selected and press the controller.
4. Turn the controller until "Vehicle / Tires" is selected and press the controller.
5. Change to upper field if necessary. Turn the controller until "PDC" is selected and press the controller.



6. Select "PDC display on" and press the controller.

The PDC screen is activated.

The display appears on the Control Display as soon as PDC is activated.

System limits

⚠ Even with PDC, final responsibility for estimating the distance between the vehicle and any obstructions always remains with the driver. Even when sensors are provided, there is a blind spot in which objects can no longer be detected. The system is also subject to the physical limits that apply to all forms of ultrasonic measurement, such as those encountered with tow bars and trailer couplings, or thin and wedge-shaped objects etc.

Low objects already displayed, e.g. curbs, can also disappear from the detection area of the sensors again before or after a continuous tone already sounds. Higher, protruding objects, e.g. ledges, cannot be detected. For this reason, drive with care; otherwise, there is a danger of personal injury or property damage. Loud sources of sound, inside and outside the vehicle, could drown out the PDC signal tone. ◀

Driving stability control systems

Your BMW is equipped with an extended array of systems designed to enhance and maintain vehicle stability under extreme conditions.

ABS Antilock Brake System

ABS prevents locking of the wheels during braking. Safe steering response is maintained even during full braking. Active safety is thus increased.

The ABS is operational every time you start the engine. Braking safely refer to page 136.

CBC Cornering Brake Control

When braking during curves or when braking during a lane change, driving stability and steering response are improved further.

Electronic brake-force distribution

The system controls the brake pressure in the rear wheels to ensure stable braking behavior.

Brake assistant

When you apply the brakes rapidly, this system produces maximum braking force boosting and thus helps to achieve the shortest possible braking distance during full braking maneuvers. This system exploits all of the benefits provided by ABS.

Do not reduce the pressure on the brake pedal for the duration of the full braking.

Adaptive brake assistant*

In conjunction with the active cruise control with the stop-and-go function, the adaptive brake assistant ensures that the brake responds even more quickly during braking with the brake assistant.

DSC Dynamic Stability Control

DSC prevents traction loss in the driving wheels when starting off and accelerating. The system also identifies unstable driving conditions, such as a loss of traction at the rear of the vehicle or sliding of the vehicle in its front wheels. In these cases, DSC helps the vehicle maintain a safe course within physical limits by reducing engine output and through braking actions in the individual wheels.

 The laws of physics cannot be repealed, even with DSC. An appropriate driving style always remains the responsibility of the driver. Therefore, do not restrict the additional safety margin with a risky driving style, as otherwise there is a risk of an accident. ◀

Deactivating DSC



Press the button until the DSC indicator lamp in the instrument cluster lights up, but not longer than approx. 10 seconds. DTC Dynamic Traction Control and DSC are deactivated together. Stabilizing and drive output promoting actions are no longer executed. In addition, the stability promoting intervention of the active steering* is deactivated, refer to page 99.

A message appears on the Control Display. Please note any supplementary information that appears there.

To increase vehicle stability, activate DSC again as soon as possible.

Activating DSC

Press the button; the indicator lamp in the instrument cluster goes out.

For better control



The indicator lamp flashes: DSC controls the drive forces and brake forces.

The indicator lamp lights up: DSC is deactivated.

DTC Dynamic Traction Control

DTC is a version of DSC in which the drive output is optimized for particular road conditions, e.g. unplowed snow-covered roads. The system assures the maximal drive output, but with reduced driving stability. It is therefore necessary to drive with appropriate caution.

You may find it useful to briefly activate DTC under the following special circumstances:

- ▷ When driving on snowy inclines, in slush, or on unplowed, snow-covered road surfaces
- ▷ When rocking a stuck vehicle free or starting off in deep snow or on loose ground
- ▷ When driving with snow chains*

Activating DTC



Press the button briefly; the DTC indicator lamp in the instrument cluster lights up.

For better control



The indicator lamp flashes: DTC controls the drive forces and brake forces.

DTC

The indicator lamp lights up: DTC is activated.

Deactivating DTC

Press the button again; the DTC indicator lamp in the instrument cluster goes out.

xDrive*

xDrive is the 4-wheel drive system of your BMW. The combined effects of xDrive and DSC further optimize the traction and dynamic driving characteristics. The 4-wheel drive system xDrive variably distributes the drive torque to the front and rear axle depending on the driving situation and prevailing road conditions.

HDC Hill Descent Control*

The concept

HDC is a system for driving downhill in steep terrain. This system reduces vehicle speed on steep downhill gradients, thus allowing you to maintain even better control of your BMW under these conditions. The vehicle moves at approximately twice walking speed without active intervention from the driver.

HDC is available for activation at vehicle speeds below approx. 22 mph/35 km/h. When driving down steep hills with a speed below approx. 22 mph/35 km/h, the vehicle reduces speed automatically down to approximately twice normal walking speed, approx. 7 mph/12 km/h, and then keeps this speed constant.

You can use the accelerator or brakes to vary this automatically controlled speed within a range extending from approx. 3 mph/5 km/h to 15 mph/25 km/h.

You can specify a target speed within the same range by using the lever of the cruise control*.

Activating HDC

You can activate HDC:

- ▷ with the programmable buttons on the steering wheel, refer to page 56
- ▷ using iDrive

iDrive, for operating principle refer to page 16.

1. Press the **MENU** button.
This opens the start menu.
2. Press the controller to open the **i** menu.
3. Select "Settings" and press the controller.
4. Select "Vehicle / Tires" and press the controller.
5. Change to upper field if necessary. Turn the controller until "HDC" is selected and press the controller.



6. Select "HDC on" and press the controller.
HDC is shown in the instrument cluster.

If the vehicle applies the brakes, a message is displayed on the Control Display for approx. 20 seconds.

Deactivating HDC

When you use the programmable buttons on the steering wheel or via iDrive, the HDC display goes out.

HDC is automatically deactivated at speeds greater than approximately 37 mph/60 km/h.

Using HDC

Manual transmission:

Use HDC in low gears and reverse gear.

Automatic transmission:

You can use HDC in every drive position.

Displays in instrument cluster



- 1 Display for target speed
- 2 HDC display

Malfunction in driving-stability control systems

 The warning lamp for the brake system lights up yellow, together with the indicator lamps for ABS, DSC and Tire Pressure Monitor or Flat Tire Monitor. A message appears on the Control Display. The driving-stability control systems have failed. While you may continue, you should remember to proceed cautiously and drive defensively while avoiding full brake applications. The Tire Pressure Monitor or the Flat Tire Monitor is also malfunctioning. Have the system checked as soon as possible.

 Display of the previously described malfunction in Canadian models.



 The DSC indicator lamp lights up. A message appears on the Control Display. A malfunction has occurred in the DSC and DTC. The stabilizing actions are no longer available. The vehicle remains operational. Have the system checked as soon as possible.

 The brake system warning lamp lights up yellow. A message appears on the Control Display. The brake assistant is defective. Have the system checked as soon as possible.

 Display of the previously described malfunction in Canadian models.

Starting assistant

The starting assistant enables you to start off conveniently on slopes. The handbrake is not required for this purpose.

1. Hold the vehicle with the brake.
2. Release the brake and begin to drive immediately.

 After releasing the brake, begin to drive immediately; otherwise, the starting assistant no longer holds the vehicle after approx. 2 seconds and your vehicle will start to roll backward. ◀

Dynamic Drive*

The concept تلفن مشاوره: ۰۲۱-۸۸۸۸۸۸۸۸

Dynamic Drive minimizes body roll and optimizes vehicle stability during cornering and evasive maneuvers.

Dynamic Drive is based on active stabilizers on the front and rear axles. Suspension compliance adapts to suit driving conditions, varying from performance-oriented during cornering to smooth and comfort-oriented when the vehicle is proceeding in a straight line. During vehicle operation, the system continuously runs through closed-loop control cycles lasting only fractions of a second.

The system assumes operational status each time you start the engine.

Sports Wagon: self-leveling suspension

Malfunction



The warning lamp for self-leveling suspension lights up yellow and a message is shown on the Control Display. A malfunction has occurred in the self-leveling sus-

sension. Stop and check the vehicle. If it is considerably lower at the rear than at the front, and possibly also on one side – rear left compared to rear right –, go to the nearest BMW center or a workshop that works according to BMW repair procedures with correspondingly trained personnel. Drive with appropriate caution in the meantime. The vehicle has reduced ground clearance and driving comfort may be noticeably reduced. Even if the position of the vehicle is normal, go to the nearest BMW center or a workshop that works according to BMW repair procedures with correspondingly trained personnel.

FTM Flat Tire Monitor*

The concept

The Flat Tire Monitor detects a pressure loss in one tire by comparing the speeds of the individual wheels during driving.

In the event of a pressure loss, there is a change in the rolling circumference and therefore the rotation speed of the corresponding wheel. The system detects this change and reports it as a flat tire.

Functional requirement

In order to ensure that a flat tire is reported correctly, the system must be initialized while the tires have the correct inflation pressure.

 The initialization must be repeated after each time the tire inflation pressure is corrected and after every tire or wheel change. ◀

System limits

The Flat Tire Monitor cannot indicate sudden severe tire damage caused by outside factors and does not detect a natural, even pressure drop in all four tires.

In the following situations, the system could be delayed or malfunction:

- ▷ System has not been initialized
- ▷ Driving on snowy or slippery road surface
- ▷ Sporty driving style: slip in the drive wheels, high lateral acceleration
- ▷ Driving with snow chains*

When you are driving with the compact wheel* the Flat Tire Monitor is unable to function.

Initializing system



The initialization finishes during driving, which can be interrupted at any time.

When driving resumes, the initialization is continued automatically. The system is initialized after this activation phase. When driving with snow chains* or a compact tire*, the system is not initialized. ◀

iDrive, for operating principle refer to page 16.

1. Press the **MENU** button.
This opens the start menu.
2. Press the controller to open the **i** menu.



3. Turn the controller until "Settings" is selected and press the controller.
4. Select "Vehicle / Tires" and press the controller.

5. Change to upper field if necessary. Turn the controller until "FTM" is selected and press the controller.

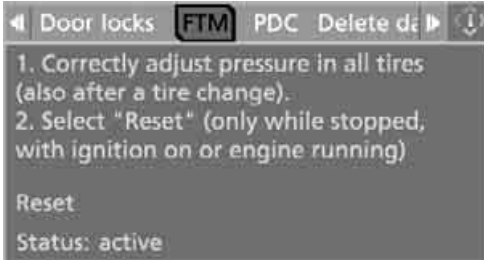

6. Start the engine, but do not start driving.
7. Select "Reset" and press the controller.
8. Select "Yes" and press the controller.



9. Start to drive. "resetting FTM ..." is displayed. The initialization finishes during driving.

Indication of a flat tire



The warning lamp lights up red. A message appears on the Control Display. In addition, an acoustic signal sounds.

There is a flat tire or extensive inflation pressure loss.

1. Reduce speed and stop the vehicle carefully. Avoid sudden braking and steering maneuvers.
2. Identify damaged tire.
 - ▶ If identification is not possible, contact a BMW center. ◀
3. Replace the damaged wheel, refer to Changing wheels on page 248.

Run-flat tires*

1. Cautiously reduce speed to below 50 mph/ 80 km/h. Avoid severe braking and steering maneuvers and do not exceed a speed of 50 mph/80 km/h.



If the vehicle is not equipped with run-flat tires, refer to page 229, do not continue driving. Continuing to drive with a flat tire could cause severe accidents. ◀

2. At the next opportunity, check the air pressure in all four tires.



If the tire inflation pressure in all four tires is correct, the Flat Tire Monitor may not have been initialized. The system must then be initialized. ◀

3. In the event of complete tire pressure loss, 0 psi/0 kPa, you can estimate the possible distance for continued driving on the basis of the following guide values:

- ▶ With a light load:
1 to 2 persons without luggage:
approx. 155 miles/250 km

- ▶ With a medium load:
2 persons, cargo bay full, or
4 persons without luggage:
approx. 94 miles/150 km

- ▶ With a full load:
4 or more persons, cargo bay full:
approx. 30 miles/50 km



Drive cautiously and do not exceed 50 mph/80 km/h or else you run the risk of causing an accident. In the event of pressure loss, vehicle handling changes. This includes reduced tracking stability in braking, extended braking distance and altered natural steering characteristics.

If unusual vibrations or loud noises occur while the vehicle is being driven, this can indicate final failure of the damaged tire. Reduce speed and stop at a suitable location as soon as possible, otherwise pieces of the tire could become detached and cause an accident. Do not continue driving, but instead contact your BMW center. ◀

TPM Tire Pressure Monitor*

The concept

TPM checks the tire inflation pressure in the four mounted tires. The system reports when the tire inflation pressure has dropped considerably in one or several tires.

Functional requirement

In order to assure the reliable reporting of a flat tire, the system must be reset at the correct tire inflation pressure.

Always use wheels with TPM electronics, otherwise fault-free operation of the system is not ensured.

 Reset the system again after each correction of the tire inflation pressure and after every tire or wheel change. ◀

System limits

TPM cannot announce sudden serious tire damage caused by external influences.

The system does not function properly if it has not been reset, e.g. a flat tire is reported despite correct tire inflation pressures.

The system is inactive and cannot display a flat tire if a wheel has been mounted without TPM electronics, e.g. a compact wheel, or if TPM is temporarily interfered with by other systems or devices which use the same radio frequency.

Status display on Control Display

The tire and system status is indicated by the color of the tires.

TPM takes the fact that the tire pressure changes during driving into account. A correction is only required if requested by TPM with the color.

Green

The tire pressure matches the learned set state. "TPM active" appears on the Control Display.

One wheel is yellow

Flat tire or a major drop in inflation pressure in the indicated tire. A message appears on the Control Display.

All wheels are yellow

Flat tire or a major drop in inflation pressure in several tires. A message appears on the Control Display.

Gray

The system cannot detect a flat tire.

Reasons for this can be:

- ▷ TPM is being reset
- ▷ Temporary interference due to systems or devices which use the same radio frequency
- ▷ Malfunction

Resetting system

 Reset the system again after each correction of the tire inflation pressure and after every tire or wheel change. ◀

Resetting finishes during driving, which can be interrupted at any time. When driving resumes, resetting is continued automatically. Do not reset the system when driving with a compact wheel*.

iDrive, for operating principle refer to page 16.

1. Press the **MENU** button.
This opens the start menu.
2. Press the controller to open the **i** menu.
3. Select "Settings" and press the controller.
4. Select "Vehicle / Tires" and press the controller.

5. Change to upper field if necessary. Turn the controller until "TPM" is selected and press the controller.



6. Start the engine, but do not start driving.
7. Select "Reset" and press the controller.
8. Select "Yes" and press the controller.





9. Start to drive.
The tires are shown in gray and "Resetting TPM..." is displayed.

After a few minutes of driving, the set tire inflation pressures in the tires are applied as the set values to be monitored. Resetting finishes during driving. The tires are shown in green on the Control Display.

 If a flat tire is detected during resetting and applying the tire inflation pressures, all tires are shown in yellow on the Control Display. The message "Tire low!" is displayed. ◀

Message with low tire inflation pressure

 The warning lamp lights up yellow. A message appears on the Control Display. In addition, an acoustic signal sounds. There is a flat tire or extensive inflation pressure loss.

1. Reduce speed and stop the vehicle carefully. Avoid sudden braking and steering maneuvers.
2. Check whether your vehicle is equipped with standard tires or run-flat tires.
 You will recognize run-flat tires by a circular symbol containing the letters RSC on the side of the tire, refer to page 229. ◀

Standard tires

1. If all four wheels are shown in yellow, identify the damaged tire on the vehicle.
2. Replace the damaged wheel or wheels, refer to Changing wheels on page 248.

In contrast to a compact wheel, a spare wheel is equipped with the necessary TPM electronics and also monitored after mounting and after resetting the system.

Have the tire replaced by a BMW center or a workshop informed on handling TPM which works according to BMW repair procedures with correspondingly trained personnel.

Run-flat tires*

1. Cautiously reduce speed to below 50 mph/80 km/h. Avoid severe braking and steering maneuvers and do not exceed a speed of 50 mph/80 km/h.
 If the vehicle is not equipped with run-flat tires, refer to page 229, do not continue driving. Continuing to drive with a flat tire could cause severe accidents. ◀
2. In the event of complete tire pressure loss, 0 psi/0 kPa, you can estimate the possible distance for continued driving on the basis of the following guide values:

- ▷ With a light load:
1 to 2 persons without luggage:
approx. 155 miles/250 km
- ▷ With a medium load:
2 persons, cargo bay full, or

4 persons without luggage:
approx. 95 miles/150 km

- ▷ With a full load:
4 or more persons, cargo bay full:
approx. 30 miles/50 km



Drive reservedly and do not exceed a speed of 50 mph/80 km/h. In the event of pressure loss, vehicle handling changes. This includes reduced tracking stability in braking, extended braking distance and altered natural steering characteristics.

If unusual vibrations or loud noises occur while the vehicle is being driven, this can indicate final failure of the damaged tire. Reduce speed and stop at a suitable location as soon as possible, otherwise pieces of the tire could become detached and cause an accident. Do not continue driving, but instead contact your BMW center. ◀

Malfunction



The yellow warning lamp flashes and then lights up continuously. The tires are shown in gray on the Control Display and a message is displayed. No flat tire can be detected.

A message like this is displayed in the following situations:

- ▷ In case of a malfunction; have the system checked.
- ▷ If a wheel is mounted without TPM electronics.
- ▷ If TPM is temporarily interfered with by other systems or devices which use the same radio frequency.

Declaration according to NHTSA/ FMVSS 138 Tire Pressure Monitoring Systems

Each tire, including the spare, should be checked monthly when cold and inflated to the inflation pressure recommended by the vehicle manufacturer on the vehicle placard or tire inflation pressure label. If your vehicle has tires of a different size than the size indicated on the vehicle placard or tire inflation pressure label, you should determine the proper tire inflation

pressure for those tires. As an added safety feature, your vehicle has been equipped with a tire pressure monitoring system, TPMS, that illuminates a low tire pressure telltale when one or more of your tires are significantly underinflated. Accordingly, when the low tire pressure telltale illuminates, you should stop and check your tires as soon as possible, and inflate them to the proper pressure. Driving on a significantly underinflated tire causes the tire to overheat and can lead to tire failure. Underinflation also reduces fuel efficiency and tire tread life, and may affect the vehicle's handling and stopping ability. Please note that the TPMS is not a substitute for proper tire maintenance, and it is the driver's responsibility to maintain correct tire pressure, even if underinflation has not reached the level to trigger illumination of the TPMS low tire pressure telltale.

The TPMS malfunction indicator is combined with the low tire pressure telltale. When the system detects a malfunction, the telltale will flash for approximately one minute and then remain continuously illuminated. This sequence will continue upon subsequent vehicle startups as long as the malfunction exists. When the malfunction indicator lights up, the system may not be able to detect or signal low tire pressure as intended. TPMS malfunctions may occur for a variety of reasons, including the installation of replacement or alternate tires or wheels on the vehicle that prevent the TPMS from functioning properly. Always check the TPMS malfunction telltale after replacing one or more tires or wheels on your vehicle to ensure that the replacement or alternate tires and wheels allow the TPMS to continue to function properly.

Active steering*

The concept

The active steering is a system that actively varies the steering angle of the front wheels in relation to the steering wheel movements.

When you are driving in the low road speed range, e.g. in a town or when parking, the steering angle increases, i.e. the steering becomes

very direct. In the higher speed range, on the other hand, the steering angle is reduced more and more. This improves the handling capability of your BMW over the entire speed range.

In critical situations, the system can make targeted corrections to the steering angle provided by the driver and thus stabilize the vehicle before the driver intervenes. This stabilizing intervention is simultaneously deactivated when DSC is switched off, refer to page 92.

Malfunction



The warning lamp lights up yellow and a message is shown on the Control Display. Active steering is malfunctioning or is temporarily deactivated. Greater steering wheel movements are required at low speeds, while the vehicle reacts more sensitively to steering wheel movements at higher speeds.

The stability-promoting intervention can also be deactivated. Proceed cautiously and drive defensively. Have the system checked if the active steering is malfunctioning.

Brake force display



On the left: normal braking.

On the right: heavy braking.

Airbags



The following airbags are located under the marked covers:

- 1 Front airbags
- 2 Head airbags
- 3 Side airbags in front and rear

Protective action



To ensure that the safety systems continue to provide optimized protection, please observe the adjustment instructions on page 47. ◀

The front airbags help protect the driver and front passenger by responding to frontal impacts in which safety belts alone cannot pro-

vide adequate restraint. When needed, the head and side airbags help provide protection in the event of side impact. The relevant side airbag supports the side upper body area. The head air bag supports the head.

The airbags are deliberately not triggered in every impact situation, e.g. less severe accidents or rear-end collisions.



Do not apply adhesive materials to the cover panels of the airbags, cover them or modify them in any other way. Do not attempt to remove the airbag restraint system from the vehicle. Do not modify or tamper with either the wiring or the individual components in the airbag system. This category includes the uphol-

stery in the center of the steering wheel, on the instrument panel, the doors and the roof pillars along with the sides of the headliner. Do not attempt to remove or dismantle the steering wheel. Do not touch the individual components immediately after the system has been triggered, because there is a danger of burns.

In the event of malfunctions, deactivation, or triggering of the airbag restraint system, have the testing, repair, removal, and disposal of airbag generators executed only by a BMW center or a workshop that works according to BMW repair procedures with correspondingly trained personnel and has the required explosives licenses. Otherwise unprofessional attempts to service the system could lead to failure in an emergency or undesired airbag triggering, either of which could result in personal injury. ◀

Warnings and information on the airbags is also provided on the sun visors.

Automatic deactivation of front passenger airbags

The occupation of the seat is detected by evaluating the impression on the occupied seat surface of the front passenger seat. The front and side airbags on the front passenger side are activated or deactivated accordingly by the system.

▶ The current status of the front passenger airbag, i.e. deactivated or activated, is indicated by the indicator lamp over the interior rearview mirror, refer to Operating state of front passenger airbags in the following. ◀

⚠ Before transporting a child on the front passenger seat, observe the safety information and handling instructions under Transporting children safely refer to page 58.

The front and side airbags on the front passenger side can be deactivated for teenagers and adults in certain sitting positions; then the indicator lamp for the front passenger airbags lights up. In these cases, change the sitting position so that the front passenger airbags are activated and the indicator lamp goes out. If the desired status cannot be produced by changing the sitting position, transport the corresponding person on the rear seat. Do not fit seat cov-

ers, seat cushion padding, ball mats or other items onto the front passenger seat unless they are specifically recommended by BMW. Do not lay objects under the seat which could press against the seat from below. Otherwise a correct evaluation of the occupied seat surface cannot be ensured. ◀

Operating state of front passenger airbags



Depending on the vehicle's equipment, the arrangement of the switches and indicator lamps may differ somewhat.

The indicator lamp for the front passenger airbags indicates the operating status of the front and side airbags on the front passenger side depending on the seat occupation. The indicator lamp shows whether the front passenger airbags are activated or deactivated.

▶ The indicator lamp lights up when a child in a child restraint system intended for the purpose is properly detected on the seat. The front and side airbags on the front passenger side are not activated.

▶ Most child's seats are detected by the system. Especially the child's seats required by the NHTSA at the time the vehicle is manufactured. After installing a child's seat, make sure that the indicator lamp for the front passenger airbags lights up. This indicates that the child's seat has been detected and the front passenger airbags are not activated. ◀

▶ The indicator lamp does not light up if, for example, the system detects a person of sufficient size seated correctly on the seat. The front and side airbags on the front passenger side are activated.

- ▷ The indicator lamp does not light up when the seat is empty. However, the front and side airbags on the front passenger side are not activated.

Operational readiness of airbag system



From radio readiness, refer to page 62, the warning lamp lights up briefly, indicating the operational readiness of the entire airbag system and the safety belt tensioners.

Airbag system malfunction

- ▷ Warning lamp does not light up from radio readiness.
- ▷ Warning lamp lights up continuously.

 Have the airbag system checked immediately in case of a malfunction, otherwise there is a danger that the airbag system may not respond in the expected manner in an accident despite an impact of corresponding intensity.

Head-Up Display*

The concept

With the Head-Up Display important information is projected into the driver's field of view, e.g. navigation instructions. This enables you to take in this information without looking away from the road.



Switching on/off

Press the button.



- 1 Navigation instructions
- 2 Display
 - ▷ Cruise control
 - ▷ Active cruise control
 - ▷ Leaving lane warning
- 3 Speed

Selecting displays

iDrive, for operating principle refer to page 16.

1. Press the **MENU** button. This opens the start menu.
2. Press the controller to open the **i** menu.
3. Select "Settings" and press the controller.

- Select "Display settings" and press the controller.
- Change to upper field if necessary. Turn the controller until "Head-Up Display" is selected and press the controller.
- Change into the second field from the top. Turn the controller until "Head-Up Display" is selected and press the controller.
- Select desired information of Head-Up Display.



- Press the controller.
 The information appears in the Head-Up Display.

The settings are stored for the remote control currently in use.

Setting brightness

The brightness of the display is adapted to the ambient lighting conditions. However, you can change the basic setting. With the low beams switched on, the brightness can also be adjusted with the knurled wheel of the instrument lighting.

iDrive, for operating principle refer to page 16.

- Press the **MENU** button.
This opens the start menu.
- Press the controller to open the **i** menu.
- Select "Settings" and press the controller.
- Select "Display settings" and press the controller.
- Change to upper field if necessary. Turn the controller until "Head-Up Display" is selected and press the controller.

- Change into the second field from the top. Turn the controller until "Brightness" is selected and press the controller.



- Turn the controller until the desired setting is selected.

The setting is stored for the remote control currently in use.

Notes

The visibility of the displays in the Head-Up Display is influenced by:

- ▷ Sunglasses with certain polarization filters
- ▷ Certain seating positions
- ▷ Objects on the cover of the Head-Up Display
- ▷ Wet road surface and unfavorable lighting conditions

If the image is distorted, please have the basic setting checked at a BMW center.

Special windshield

The windshield is part of the system. The shape of the windshield complies with the requirements of the Head-Up Display to enable a precise display. A film in the windshield prevents the double images from being displayed. Windshield replacement should be carried out by a BMW center or a workshop that works according to BMW repair procedures with correspondingly trained personnel.

Care instructions

You can find valuable information on this topic under Care, starting on page 239.



 Only clean the cover of the Head-Up Display with a soft, nonabrasive cloth or with a display cleaning cloth; otherwise, you may damage it. ◀

BMW Night Vision*

The concept

BMW Night Vision is a driver assistance system that is designed to provide enhanced vision for certain objects at night. This can be especially helpful for detecting people and larger animals. When objects are detected, the driver may be able to take appropriate action sooner. For example, the driver may identify and detect the presence of persons or animals in the road ahead or off to the sides and can be more alert, slow down or stop, blow the horn etc. The driver can decide which actions are appropriate and then react accordingly.

A certain area in front of the vehicle is viewed by an infrared camera and a generated image is shown on the Control Display. The resulting thermal image shows the relative heat radiation of the objects present in the camera's field of view. Warmer objects appear brighter and cooler objects appear darker. Contrast is dependent on the temperature difference between the objects and the background and on the amount of heat radiation of the object itself. As a result, it is quite possible that a person is not continually recognizable as a person in shape, since the thermal radiation can be affected by different clothing which blocks heat loss. Objects with little temperature difference to the surrounding area, or little heat radiation are less noticeable, for example in cold weather.

Any improvement in detection depends on many factors such as the object size and temperature compared to the surroundings, or other nearby objects, the visual recognition skills of the driver, weather conditions, and other factors.

Driving hints

With the system active, periodically but briefly, glance at the thermal image on the Control Display to notice objects that could be people or larger animals. The glance should be similar to glancing at the rear view mirror. Do not stare at the image for long periods while driving, as this will remove attention from the road. If you notice an object of interest ahead, be prepared to slow down or stop, blow the horn, or take other appropriate action.

System limits

The system is designed to supplement but not replace forward vision through the windshield. The driver is responsible for safe driving at night. BMW Night Vision is not designed to be used as a continuous viewing window for driving at night.



No system, no matter how sophisticated, can operate without limitations. BMW Night Vision operation is subject to physical and environmental limitations that will reduce the ability of the system to detect and display a clear thermal image. Some of the situations in which these limitations can occur are:

- ▷ on steep hilltops or depressions and in tight curves
- ▷ in tunnels, as the contrast is inherently low
- ▷ when the camera lens is dirty

- ▷ in dense fog, heavy rain or snowfall
- ▷ when displaying very hot objects such as transformers, car exhausts etc.
- ▷ when the image briefly freezes during normal system adjustment.

 BMW Night Vision's potential benefits can be limited by the driving style of the driver, the size and relative temperature of the detected objects, dirt or contamination on the camera lens, adverse weather like snow, rain or fog, and other factors not mentioned here. It will always be the driver's responsibility to drive at a speed and in a manner that recognizes potential hazards and adjust accordingly.

BMW Night Vision is not a substitute or replacement for the driver's responsibility to adapt to visibility and traffic conditions. The forward view illuminated by the headlamps must always be the basis for making safe driving decisions, otherwise a safety risk will result. ◀

Activating BMW Night Vision

1. Turn the light switch to position **2** or **3**, refer to page 108.
2. With low beams switched on:
 - ▷ Press the  button. Depending on the vehicle's equipment, the location of the button may differ somewhat.



- ▷ Press one of the programmable buttons on the steering wheel, refer to page 56.

The image will be displayed on the Control Display after a few seconds. Depending on the last mode selected, either the normal or full screen image will be displayed.



Due to the system's need to adjust periodically, a still image is displayed at certain intervals for fractions of a second. This is normal and not an indication of a problem.

To prevent driving without headlamps, at a speed of more than approx. 3 mph/5 km/h and when dark, the thermal image on the Control Display is only shown when the low beams are on.

Deactivating BMW Night Vision

- ▷ Press the  button.
- ▷ Press the button on the steering wheel.
- ▷ Press the **MENU** button.
- ▷ Via iDrive, refer to Selecting settings.

Selecting settings

For iDrive details, refer to page 16.

1. Activate BMW Night Vision.
2. Press the controller to display the menu items.

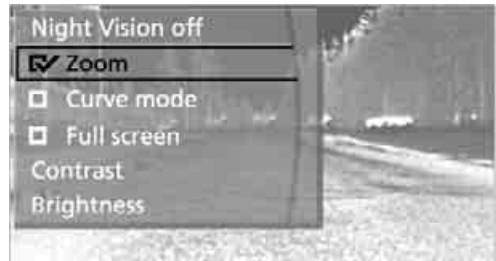

3. Select the menu item and press the controller:

- ▷ "Night Vision off":
Deactivate BMW Night Vision.
- ▷ "Zoom":
At higher speeds, the image is zoomed in.
- ▷ "Curve mode":
Depending on the steering angle and other parameters, the image section follows the course of the road to some degree.
- ▷ "Full screen":
The image is shown on the entire Control Display.
- ▷ "Contrast":
The contrast of the screen can be adjusted.
- ▷ "Brightness":
The brightness of the screen can be adjusted.

 "Curve mode" can only be activated with the "Zoom" function switched on. With "Full screen" activated, "Curve mode" and "Zoom" cannot be selected. ◀

The settings are stored for the remote control currently in use.

To exit the menu:

The image automatically disappears after approx. 5 seconds.

Cleaning camera



The function of the camera may be affected by heavy rain and fog, dirt, snow or ice on the lens. When this occurs, the displayed image on the Control Display may become gray.

To minimize icing, the camera lens is automatically heated. However, it may be necessary to clean the camera lens manually under severe weather conditions. When doing so, cautiously remove any debris, ice or snow. To avoid damage to the lens, do not use sharp or abrasive instruments to clean ice, snow, or dirt off the lens.

When the windshield is cleaned with the headlights on, the camera lens area is automatically sprayed as well. Refer to page 69.

Leaving lane warning*

The concept

This system warns you from a speed of approx. 40 mph/70 km/h when the vehicle is leaving the lane you are currently in on roads with lane limit lines. You feel this due to a slight vibration of the steering wheel.

The system does not warn you if you signal before leaving the lane.

It is best to use the system on well-developed roads and freeways.

Switching on/off



Press the button on the steering wheel.

- ▷ The two lines **1** indicate that the system is activated.
- ▷ The two arrows **2** mean that the system has detected one or two lane limit lines from a speed of approx. 40 mph/70 km/h and warns accordingly.

If you activate the system below a speed of approx. 40 mph/70 km/h, a message will appear

stating that the system is not active until this speed is reached.

A warning will be canceled:

- ▷ after approx. 3 seconds
- ▷ if you return to your lane
- ▷ if you brake heavily
- ▷ if you signal

System limits



The leaving lane warning cannot serve as a substitute for your personal judgment in determining the course of the road.

If the system issues a warning, do not move the steering wheel with unnecessary severity, as otherwise you could lose control of the vehicle. ◀

The function of the system may be limited in the following example situations:

- ▷ in heavy fog, rain or snowfall
- ▷ with worn-away, poorly visible limit lines, or lines that run together or apart or are unclear, e.g. in road construction areas
- ▷ when limit lines are covered by snow, ice, dirt or a great deal of water
- ▷ in tight curves or on narrow roads
- ▷ when limit lines are not white
- ▷ when limit lines are covered by objects
- ▷ when driving up close behind a vehicle driving ahead
- ▷ with bright counter light
- ▷ when the windshield is fogged up, dirty or covered with stickers, vignettes etc. in the area of the inside rearview mirror

Lamps

Parking lamps/low beams

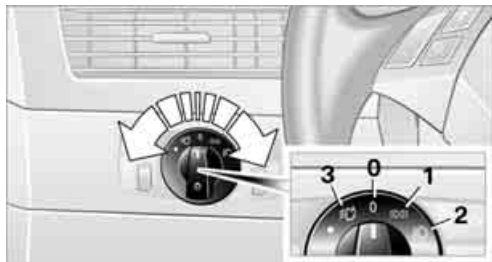

- 0 Lights off and daytime running lamps*
- 1 Parking lamps and daytime running lamps*
- 2 Low beams and welcome lamps
- 3 Automatic headlamp control*, daytime running lamps*, welcome lamps, Adaptive Head Light* and high-beam assistant*

If you open the driver's door with the ignition switched off, the exterior lighting is switched off when the light switch is in position **2** or **3**. The daytime running lamps have already been switched off at the same time as the ignition.

For this reason, switch on the side marker lamps as needed, switch position **1**; otherwise, the vehicle is not lit.

Parking lamps

In switch position **1**, the front, rear and side vehicle lighting is switched on. You can use the parking lamps for parking.

▶ The parking lamps drain the battery. Do not leave them switched on for long periods of time, otherwise it may no longer be possible to start the engine. It is preferable to switch on the roadside parking lamps on one side, refer to page [110](#). ◀

Low beams

The low beams light up when the light switch is in position **2** and the ignition is on.

Automatic headlamp control*

In switch position **3**, the system activates the low beams and switches them on or off in response to changes in ambient light conditions, for instance, in a tunnel, at dawn and dusk and in case of precipitation. Adaptive Head Light* is active. The LED next to the symbol lights up when the low beams are on. You can also activate the daytime running lamps, refer to page [109](#). In the situations described above, the lamps then switch to low beams.

A blue sky with the sun low on the horizon can cause the lights to be switched on.

▶ The low beams remain switched on independent of the ambient lighting conditions when you switch on the fog lamps*. ◀

⚠ The automatic headlamp control cannot serve as a substitute for your personal judgment in determining when the lamps should be switched on in response to ambient lighting conditions. For example, the sensors cannot detect fog or hazy weather. To avoid safety risks, you should always switch on the low beams manually under these conditions. ◀

Welcome lamps

If you leave the light switch in position **2** or **3** when parking the vehicle, then when you unlock the vehicle, the parking lamps and interior lighting remain illuminated for a brief time.

Activating/deactivating welcome lamps

iDrive, for operating principle refer to page [16](#).

1. Press the **MENU** button.
This opens the start menu.
2. Press the controller to open the **i** menu.
3. Select "Settings" and press the controller.
4. Select "Vehicle / Tires" and press the controller.

5. Change to upper field if necessary. Turn the controller until "Lighting" is selected and press the controller.



6. Select "Welcome light" and press the controller.

The welcome lamps are switched on.

The setting is stored for the remote control currently in use.

Pathway lighting

When you activate the headlamp flasher after parking the vehicle and switching off the lamps, the low beams will come on for a brief period. You can set the duration or deactivate the function via iDrive.

iDrive, for operating principle refer to page 16.

1. Open the start menu.
2. Press the controller to open the **i** menu.
3. Select "Settings" and press the controller.
4. Select "Vehicle / Tires" and press the controller.
5. Change to upper field if necessary. Turn the controller until "Lighting" is selected and press the controller.



6. Select "Pathway lighting" and press the controller.

7. Turn the controller to select the desired duration.
8. Press the controller to apply the setting.

The setting is stored for the remote control currently in use.

Daytime running lamps*

The daytime running lamps light up in position **0**, **1** and **3**. If the light switch remains in position **1**, the parking lamps light up after the ignition is switched off.

Activating/deactivating daytime running lamps*

iDrive, for operating principle refer to page 16.

1. Open the start menu.
2. Press the controller to open the **i** menu.
3. Select "Settings" and press the controller.
4. Select "Vehicle / Tires" and press the controller.
5. Change to upper field if necessary. Turn the controller until "Lighting" is selected and press the controller.

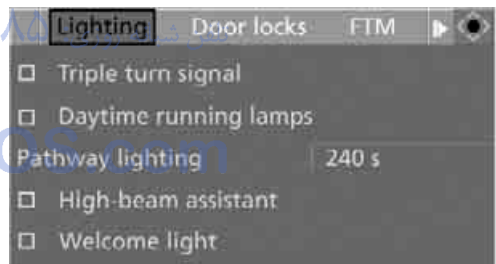

6. Select "Daytime running lamps" and press the controller.

The daytime running lamps are switched on.

The setting is stored for the remote control currently in use.

Adaptive Head Light*

The concept

Adaptive Head Light is a variable headlamp control system that enables better illumination of the road surface. Depending on the steering angle and other parameters, the light from the headlamp follows the course of the road.

In tight curves at speeds up to approx. 45 mph/ 70 km/h, e.g. on mountainous roads or when negotiating curves, turning lamps are switched on that light up the inside area of the curve.

Activating the Adaptive Head Light

With the ignition switched on, turn the light switch into position **3**, refer to page 108.

The turning lamps are automatically switched on depending on the steering angle or the use of turn signals.

To avoid blinding oncoming traffic, the Adaptive Head Light directs light towards the front passenger side when the vehicle is at a standstill. When driving in reverse, only the turning lamps are active and illuminate the outer area of curves.

High beams/ roadside parking lamps



- 1 High beams
- 2 Headlamp flasher
- 3 Roadside parking lamps

Roadside parking lamps, left or right*

You also enjoy the option of lighting up just one side of your vehicle when parking.

Switching on

After parking the vehicle, press the lever up or down beyond the resistance point, arrow **3**.



The roadside parking lamps drain the battery. Do not leave them switched on for long periods of time, otherwise it may no longer be possible to start the engine. ◀

Switching off

Briefly press the lever in the opposite direction up to the resistance point, arrow **3**.

High-beam assistant*

The concept

This system automatically switches the high beams on and off. A sensor on the front side of the inside rearview mirror controls the process. The assistant makes sure that the high beams are switched on whenever traffic conditions permit. This relieves you of the burden of constantly switching back and forth and simultaneously provides you with the best possible visibility. Naturally, you can intervene at any time to switch the high beams on and off as usual.

Activating system

1. Turn the light switch to position **3**, refer to page 108.
2. With the low beams switched on, briefly press the turn signal lever in the high-beam direction.



The indicator lamp in the instrument cluster lights up when the high-beam assistant is activated. The system automatically switches between high beams

and low beams, reacting to oncoming traffic, vehicles ahead of you, and sufficiently lit areas, e.g. in built-up zones.

Manually switching between high beams and low beams

If you wish or the situation requires, you can intervene at any time.

- ▶ If the high-beam assistant has switched on the high beams, but you wish to use the low beams, just switch on the low beams with the turn signal lever. This deactivates the high-beam assistant.
In order to reactivate the system, briefly press the turn signal lever in the high-beam direction.
- ▶ If the high-beam assistant has switched on the low beams, but you wish to use the high beams, simply switch on the high beams as usual. This deactivates the system and it is up to you to switch back to low beams.
In order to reactivate the system, briefly press the turn signal lever in the high-beam direction.
- ▶ When the low beams are on, use the head-lamp flasher as usual.

System limits

 The high-beam assistant is designed to maximize the amount of time that high beams can be safely used and to quickly switch back to low beams when traffic approaches. The system cannot completely replace driver intervention when unusual conditions are encountered. For this reason, switch to low beams when circumstances so dictate. Failure to do so can pose a safety risk. ◀

Below are a few examples of situations in which the system may not react or may only function to a limited degree, requiring personal intervention:

- ▶ in extremely unfavorable weather conditions such as fog or heavy precipitation
- ▶ in sensing road users with poor inherent illumination such as pedestrians, cyclists, equestrians, horse-drawn vehicles, railroad

or shipping traffic close to the road, and at deer crossings

- ▶ in tight curves, on steep crests or dips, with cross-traffic, or with partially hidden oncoming traffic on divided highways
- ▶ in poorly illuminated areas and in the presence of highly reflective signs
- ▶ in the low speed range
- ▶ when the windshield is fogged up, dirty or covered with stickers, decals etc. in the area of the inside rearview mirror
- ▶ when the sensor is dirty. Clean the sensor on the front side of the inside rearview mirror with a cloth slightly moistened with glass cleaner

Moreover, no system can operate without limitations. High-beam assistant operation is subject to conditions that may reduce the system's ability to recognize the difference between actual vehicle head lamps or tail lamps and, for example, highly reflective signs, markers, and streetlights. To be on the safe side, the system may periodically interpret these situations as conditions that require low beams. Below are some of the situations in which premature switching to low beams can occur:

- ▶ approaching large and/or highly reflective signs
- ▶ approaching certain lights, such as driveway lighting and porch lights
- ▶ approaching certain traffic signals
- ▶ approaching large reflective markers

In these situations, the system may interpret the above conditions as a vehicle ahead requiring a switch to low beams. When the conditions return to normal, the system will reactivate the high beams.

The high-beam assistant cannot replace the driver's responsibility for complying with state laws on high-beam switching or for adapting to visibility and traffic conditions.

Switching off via iDrive

iDrive, for operating principle refer to page 16.

1. Press the **MENU** button.
This opens the start menu.
2. Press the controller to open the **i** menu.
3. Select "Settings" and press the controller.
4. Select "Vehicle / Tires" and press the controller.
5. Change to upper field if necessary. Turn the controller until "Lighting" is selected and press the controller.



6. Select "High-beam assistant" and press the controller.
 - High-beam assistant is switched off.

The setting is stored for the remote control currently in use.

Fog lamps*



The parking lamps or low beams must be switched on for the fog lamps to operate. The green indicator lamp in the instrument cluster lights up whenever the fog lamps are on.

The fog lamps are switched off whenever the high beams are switched on.

- If the automatic headlamp control is activated, the low beams will come on when you switch on the fog lamps. ◀

Instrument lighting

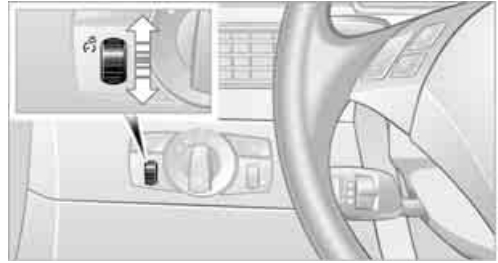

You can control the lighting intensity by using the knurled wheel.

Interior lamps

Control of the interior lamps, footwell lamps, door entry lighting, courtesy lamps* and the cargo bay lamps* is automatic.

With the courtesy lamps, LED lights are provided in the outside rearview mirrors to illuminate the exterior area around the doors.

- To protect the battery, all lamps in the vehicle are switched off approx. 15 minutes after radio readiness is switched off, refer to Start/Stop button on page 62. ◀

Switching interior lamps on and off manually



Press the button.

If the interior lamps, footwell lamps, door entry lighting and courtesy lamps are to remain switched off continually, press the button for approx. 3 seconds.

Reading lamps

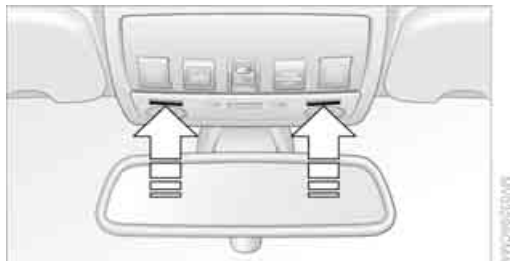

Reading lamps are located in the front and rear adjacent to the interior lamps. Press the button to switch the lamps on and off.

امداد خودرو فارما

تلفن شبانه روزی: ۰۲۱-۸۸۸۶۲۰۸۵

FarmaSOS.com

Climate

Automatic climate control

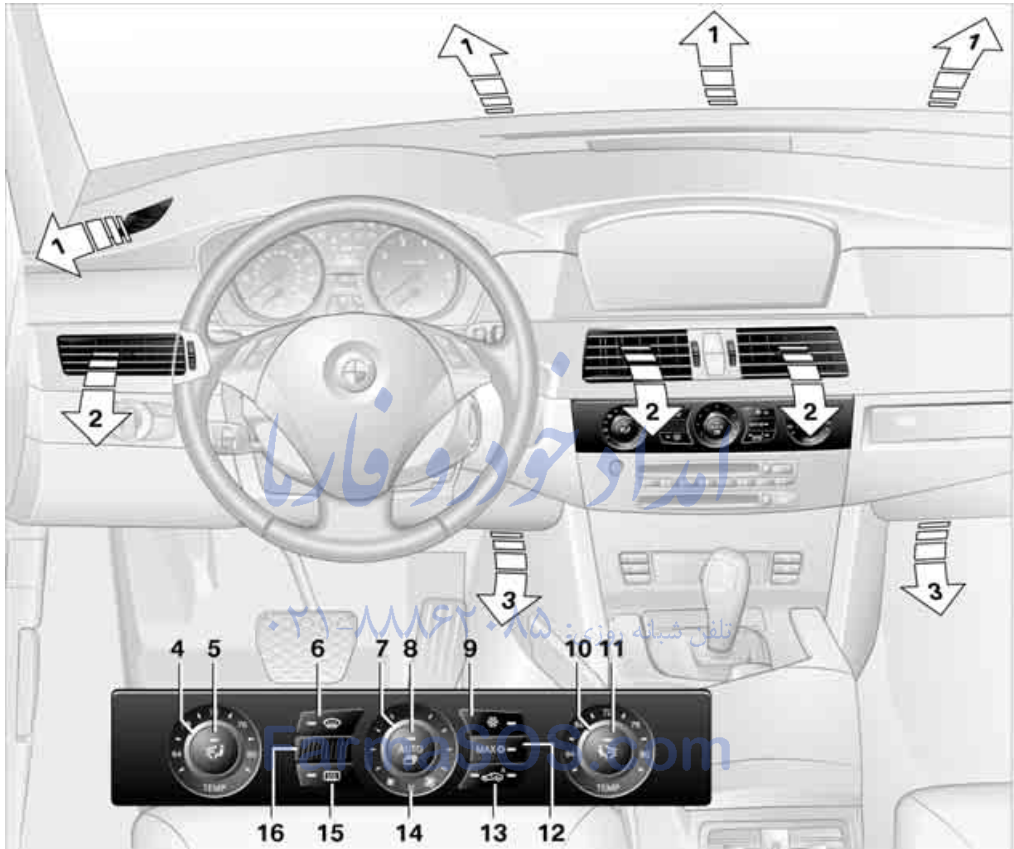

- | | |
|---|--|
| 1 Air directed toward the windshield and side windows | 8 AUTO program |
| 2 Air for the upper body region, refer to Front ventilation on page 118 | 9 Switching cooling function on and off manually |
| 3 Air to footwell | 10 Temperature, right side of passenger compartment |
| 4 Temperature, left side of passenger compartment | 11 Manual air distribution, front passenger side |
| 5 Manual air distribution, driver's side | 12 Maximum cooling |
| 6 Defrosting windows and removing condensation | 13 AUC Automatic recirculated-air control/ recirculated-air mode |
| 7 Manual air volume, switching off automatic climate control, residual heat utilization | 14 LED for residual heat utilization and parked-car ventilation system |
| | 15 Rear window defroster |

- 16 Air grill for interior temperature sensor – please keep clear and unobstructed

The current setting for air distribution is displayed on the Control Display.

A congenial climate

The AUTO program offers the optimum air distribution and air volume for virtually all conditions, refer to AUTO program below. Now you only need to select an interior temperature pleasant to you.

The following sections contain more detailed information on the available setting options.

Most settings are stored for the remote control currently in use, also refer to Personal Profile settings on page 31.

AUTO program



The AUTO program handles the adjustment of air volume and air distribution to the windshield and side windows, in the direction of the upper body and in the footwell.

It also adapts your instructions for the temperature to outside influences throughout the year.

The cooling function is switched on along with the AUTO program. At the same time, a condensation sensor controls the program in such a way that window condensation is prevented as much as possible.

Intensity of AUTO program

You can adjust the intensity of the AUTO program by repeatedly pressing the AUTO button. The respective current setting is briefly displayed on the Control Display when the button is pressed.

You can also adjust the intensity of the AUTO program via iDrive.

iDrive, for operating principle refer to page 16.

1. Press the **MENU** button.
This opens the start menu.
2. Move the controller to the left to open "Climate".

3. Select "Automatic programs" and press the controller.

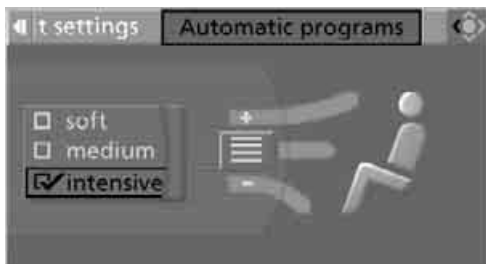

4. Select the desired intensity and press the controller.

The marked intensity of the automatic program is switched on.

Temperature



Set the desired temperature individually on the driver's and front passenger side.

The automatic climate control adjusts this temperature as quickly as possible at any time of year, if necessary with the maximum cooling or heating capacity, and then keeps it constant.

 When changing between different temperature settings in rapid succession, the automatic climate control does not have sufficient time to adjust the set temperature. ◀
In the highest setting you activate the maximum heating output, regardless of the outside temperature.

Adjusting temperature in upper body region



1. Press the button to display the current setting on the Control Display.

2. Select the field by moving the controller and turning the controller to adjust the temperature.

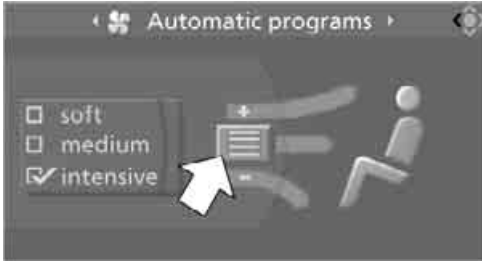

You can also adjust the temperature in the upper body region with iDrive.

iDrive, for operating principle refer to page 16.

1. Open the start menu.
2. Open "Climate".
3. Select "Vent settings" and press the controller.
4. Select the field by moving the controller and turning the controller to adjust the temperature.

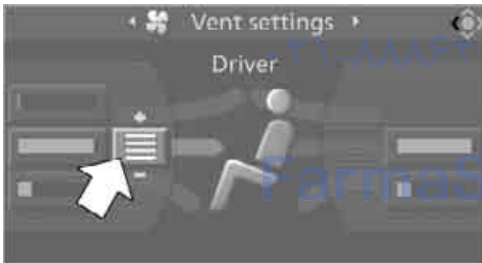

Defrosting windows and removing condensation



Quickly remove ice and condensation from the windshield and front side windows.

To do this, also switch on the cooling function.

Rear window defroster



The rear window defroster switches off after a while. Depending on the vehicle equipment, upper wires are used as an antenna and are not part of the rear window defroster.

Air volume, manual



You can adjust the air volume by turning. You can reactivate the automatic mode for the air volume with the AUTO button.

The air quantity is reduced and if need be, the ventilation is switched off in order to reduce the load on the battery. The display stays the same.

Manual air distribution

You can route the air flowing out into the vehicle interior via various programs, separately for the driver's and passenger's side:

- ▷ Upper body region
- ▷ Upper body region and footwell
- ▷ Footwell
- ▷ Driver's side: windows and footwell
- ▷ Individual program

Selecting program



Press the button repeatedly until the desired air distribution of the respective program is shown on the Control Display.

Adjusting air distribution individually – individual program

Your settings are stored in this program.

iDrive, for operating principle refer to page 16.

1. Open the start menu.
2. Open "Climate".
3. Select "Vent settings" and press the controller.

The driver's and front passenger side can be adjusted separately with the fields on the right or left side.
4. Select the driver's or front passenger side if necessary.

Move the controller to the right or left repeatedly until the driver's or front passenger side is selected.
5. Select the desired field by moving the controller.

- Turn the controller to adjust the air distribution.



Driver's side:

- Air directed toward the windshield and side windows
- Air for the upper body
- Air to footwell

Front passenger side:

- Air for the upper body
- Air to footwell

 Pressing the AUTO button cancels the manual air distribution settings. ◀

The automatic mode for the air volume remains effective with manual air distribution.

Switching cooling function on and off



The cooling function cools and dehumidifies the incoming air before also reheating it as

required, according to the temperature setting. This function is only available when the engine is running.

The cooling function helps to avoid condensation on the window surfaces or to quickly remove them.

Depending on the weather, the windshield may fog over briefly when the engine is started.

The cooling function is also switched on with the AUTO program.

Maximum cooling



Maximally cooled air is obtained as quickly as possible at an outside temperature above approx. 32 °F / 0 °C and with the engine running.

At the lowest temperature, the automatic climate control switches into recirculating air mode. The maximum air volume flows out of the vents for the upper body. Therefore, open these vents for maximum cooling.

AUC Automatic recirculated-air control/recirculated-air mode



You can respond to pollutants or unpleasant odors in the immediate environment by suspending the supply of outside air. The system then recirculates the air currently within the vehicle. During AUC operation, a sensor detects pollutants in the outside air and controls the shut-off automatically.

By pressing the button repeatedly, you can request three operating modes:

- ▶ LED off: outside air flows in continuously.
- ▶ Right LED on, AUC mode: the system detects pollutants in the outside air and shuts off the supply as needed.
- ▶ Left LED on, recirculated-air mode: the supply of outside air is permanently shut off.



Should the windows fog up in the recirculated-air mode, press the AUTO button or switch off the recirculated-air mode and increase the air volume if necessary.

The recirculated-air mode should not be used over an extended period of time, as the air quality inside the vehicle deteriorates continuously. ◀

Residual heat



The heat stored in the engine is used to heat the passenger compartment, e.g. while stopped at a school to pick up a child.

- Switch off the engine.
- Turn to the right, refer to arrow.

The function can be switched on when the following conditions are met:

- ▶ up to 15 minutes after switching off the engine
- ▶ with engine at operating temperature

- ▷ with sufficient battery voltage
- ▷ at an outside temperature below 77 °F / 25 °C

From radio readiness the interior temperature, the air volume and the air distribution can be set.

Switching automatic climate control on and off



1. Turn to the left to minimum air volume.
2. After approx. 1 second, turn to the left again.

You switch on the system again by pressing any button of the automatic climate control.

Front ventilation

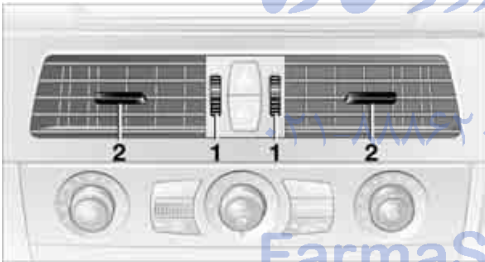

- 1 Knurled wheels to smoothly open and close vent outlets
- 2 Levers to change the vent outlet direction

⚠ Do not drop any foreign objects into the vent outlets, otherwise these could be catapulted outwards and lead to injuries. ◀

Ventilation for cooling

Adjust the vent outlets to direct the flow of cool air in your direction, for instance, if the interior has become too warm, etc.

Draft-free ventilation

Set the vent outlets so that the air flows past you and is not directed straight at you.

Rear ventilation

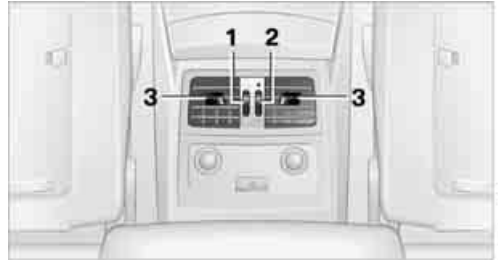

- 1 Knurled wheel to smoothly open and close vent outlets
- 2 Knurled wheel to adjust the temperature:
 - ▷ Turn toward blue: colder
 - ▷ Turn toward red: warmer
- 3 Levers to change the vent outlet direction

Microfilter/activated-charcoal filter

The microfilter removes dust and pollen from the incoming air. The activated-charcoal filter provides additional protection by filtering gaseous pollutants from the outside air. Your BMW center replaces this combined filter as a standard part of your scheduled maintenance.

Parked car ventilation

The concept

The parked car ventilation blows air into the passenger compartment to lower interior temperatures.

It is ready to use in the parked car mode at any outside temperature.

You can set two different times for the system to start. The parked car ventilation can also be switched on and off directly. It remains switched on for 30 minutes.

Since the system uses a substantial amount of electrical current, you should refrain from activating it twice in succession without allowing the battery to be recharged in normal operation between use.

The air emerges through the upper body region vent outlets in the instrument panel. These vent outlets must be open for the system to operate. The parked car ventilation is operated via iDrive.

Switching on and off directly

iDrive, for operating principle refer to page 16.

1. Open the start menu.
2. Move the controller to the left to open "Climate".
3. Select "Parked car operation" and press the controller.
4. Select "Automatic ventilation" and press the controller.
5. Select "Parked car ventilation" and press the controller.

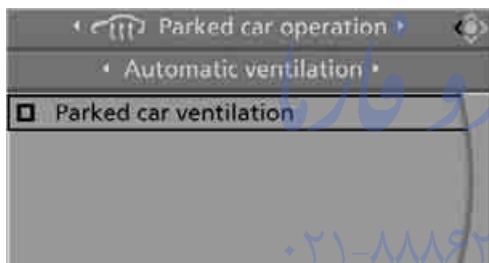

The parked-car ventilation is switched on.

The symbol on the display of the automatic climate control flashes.

Preselecting activation times

1. Open the start menu.
2. Move the controller to the left to open "Climate".
3. Select "Parked car operation" and press the controller.
4. Select "Activation time" and press the controller.

5. Move the controller to the left or right to select "Timer 1" or "Timer 2".

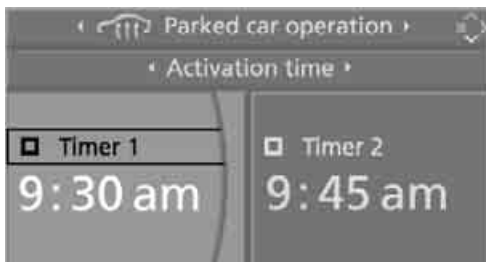

6. Select the time and press the controller. The first setting of the time display is selected.

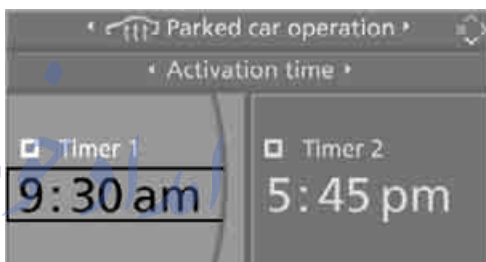

7. Turn the controller to make the adjustment.
8. Press the controller to apply the setting. The next setting is selected.
9. Make the remaining adjustments. After the last adjustment, the time is stored.

Activating activation time

Move the controller to the left or right to select "Timer 1" or "Timer 2" and press the controller.

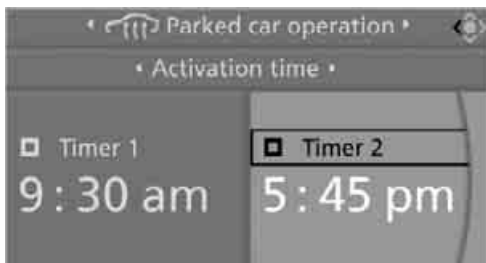

The activation time is activated.

The symbol on the display of the automatic climate control lights up.

 The symbol on the display of the automatic climate control flashes when the parked car ventilation has switched on.

 The parked car ventilation is only available for activation within the next 24 hours. Please reactivate it after this time. ◀

امداد خودرو فارما

تلفن شبانه روزی: ۰۲۱-۸۸۸۶۲۰۸۵

FarmaSOS.com

Practical interior accessories

Integrated universal remote control*

The concept

The integrated universal remote control can replace as many as three hand-held transmitters for various remote-controlled accessories, such as garage and gate or lighting systems. The integrated universal remote control registers and stores signals from the original hand-held transmitters.

The signal of an original hand-held transmitter can be programmed on one of the three memory buttons **1**. After this, the programmed memory button **1** will operate the system in question. The LED **2** flashes to confirm transmission of the signal.

Should you sell your vehicle one day, be sure to delete the stored programs beforehand for your safety, refer to page **122**.

 To prevent possible damage or injury, before programming or using the integrated universal remote control, always inspect the immediate area to make certain that no people, animals or objects are within the travel range of the device. Also, comply with the safety precautions of the original hand-held transmitter. ◀

Checking compatibility

 If you see this symbol on the packaging or in the manual supplied with the original hand-held transmitter, it is safe to assume that it is compatible with the integrated universal remote control.

 If you have additional questions, please contact your BMW center or call: 1-800-355-3515.

Information is also provided on the Internet at: www.bmwusa.com or www.homelink.com. HomeLink is a registered trademark of Johnson Controls, Inc. ◀

Programming

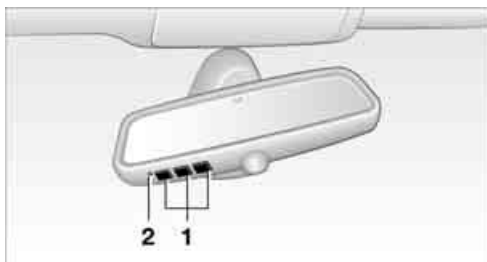

- 1 Memory buttons
- 2 LED

Fixed-code hand-held transmitters

1. Switch on ignition, refer to page **62**.
2. When starting operation for the first time: Press the left and right-hand memory button **1** for approx. 20 seconds until the LED **2** flashes quickly. All stored programs are deleted.
3. Hold the original hand-held transmitter at a distance of approx. 4 in/10 cm to 12 in/30 cm from the memory buttons **1**.

 The required distance between the hand-held transmitter and the memory buttons **1** depends on the relevant system of the original hand-held transmitter used. ◀

4. Simultaneously press the transmit button on the original hand-held transmitter and the desired memory button **1** on the integrated universal remote control. The LED **2** flashes slowly at first. As soon as the LED **2** flashes rapidly, release both buttons. If the LED **2** does not flash rapidly after approx. 15 seconds, alter the distance and repeat the step.
5. To program other original hand-held transmitters, repeat steps 3 and 4.

The corresponding memory button **1** is now programmed with the signal of the original hand-held transmitter.

You can operate the device when the engine is running or when the ignition is switched on.

▶ If the device fails to function even after repeated programming, check whether the original hand-held transmitter uses an alternating-code system. To do so, either read the instructions for the original hand-held transmitter or hold down the programmed memory button **1** of the integrated universal remote control. If the LED **2** on the integrated universal remote control flashes rapidly for a short time and then remains lit for approx. 2 seconds, this indicates that the original hand-held transmitter uses an alternating-code system. In the case of an alternating-code system, program the memory buttons **1** as described at Alternating-code hand-held transmitters. ◀

Alternating-code hand-held transmitters

To program the integrated universal remote control, consult the operating instructions for the equipment to be set. You will find information there on the possibilities for synchronization.

When programming hand-held transmitters that employ an alternating code, please observe the following supplementary instructions:

▶ Programming will be easier with the aid of a second person. ◀

1. Park your vehicle within the range of the remote-controlled device.
2. Program the integrated universal remote control as described above in the section Fixed-code hand-held transmitters.
3. Locate the button on the receiver of the device to be set, e.g. on the drive unit.
4. Press the button on the receiver of the device to be set. After step 4, you have approx. 30 seconds for step 5.
5. Press the programmed memory button **1** of the integrated universal remote control three times.

The corresponding memory button **1** is now programmed with the signal of the original hand-held transmitter.

▶ If you have any additional questions, please contact your BMW center. ◀

Deleting all stored programs

Press the left and right-hand memory button **1** for approx. 20 seconds until the LED **2** flashes quickly:

All stored programs are deleted.

Individual programs cannot be deleted.

Rememorizing individual programs

1. Hold the original handheld remote control approx. 4 in/10 cm to 12 in/30 cm away from the memory buttons **1**.

▶ The required distance between the hand-held transmitter and the memory buttons **1** depends on the relevant system of the original hand-held transmitter used. ◀

2. Press the desired memory button **1** of the integrated universal remote.
3. If the LED **2** flashes slowly after approx. 20 seconds, press the command button of the original hand-held transmitter. As soon as the LED **2** flashes rapidly, release both buttons. If the LED **2** does not flash rapidly after approx. 15 seconds, alter the distance and repeat the step.

Sun blinds*

Sun blind for rear window



Press the button on the driver's door.

Sun blinds for rear side windows

Pull the loop of the roller sun blind and hook onto bracket.

! Do not open the window with the roller sun blind deployed. Otherwise, there is a risk of damage and injury at higher speeds. ◀

Glove compartment

Opening



Pull the handle. The light in the glove compartment switches on.

! To prevent injury in the event of an accident while the vehicle is being driven, close the glove compartment immediately after use. ◀

Closing

Raise the lid into the closed position.

Locking

Lock with a key.

▶ If you only hand over the remote control without the integrated key, e.g. for valet parking, refer to page 30, the glove compartment cannot be unlocked. ◀

USB interface for data transmission



Port for importing and exporting data on USB devices, e.g. music collections.

Observe the following when connecting:

- ▶ Do not use force when plugging the connector into the USB-audio interface.
- ▶ Do not connect devices such as fans or lamps to the USB-audio interface.
- ▶ Do not connect USB hard disks.
- ▶ Do not use the USB interface to recharge external devices.

Front center armrest

The compartment in the center armrest is divided into two sections.

Opening cover

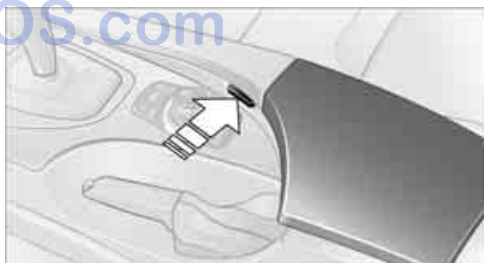

Press the button. The cover opens somewhat and can be folded upwards.

Depending on vehicle equipment, the upper section contains a compartment with a mat that can be removed for cleaning or a telephone cradle*.

Opening upper compartment



Press button and fold cover upward.

Accessing lower compartment

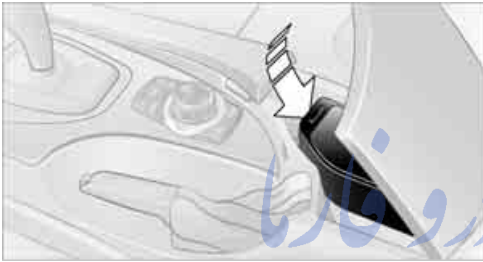

Press the button at the front and fold the upper compartment or the telephone cradle upward.

Ventilating lower compartment*

Push the slide in the lower compartment upward.

 Depending on the automatic climate control setting, the temperature inside the ventilated compartment may be higher than in the rest of the interior. Should this be the case, push the slide downward to close off the ventilation. ◀

Adjusting

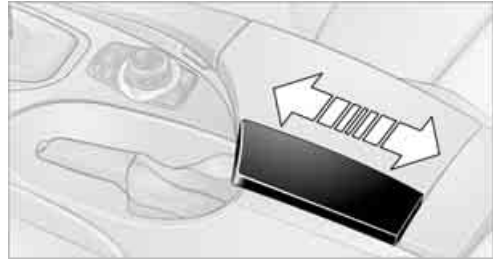

Push the illustrated section of the center armrest into the desired position.

Connection for external audio device

You can connect an external audio device such as a CD or MP3 player and play audio tracks over the vehicle's speaker system:

- ▷ AUX-IN connection, refer to page 188.
- ▷ USB-audio interface*, refer to page 189.

Storage compartments

Storage compartments are located on the doors, in the front center console and in the rear.

Storage nets are located on the backrests of the front seats, and a net* is provided in the front passenger footwell.

 Do not stow hard or sharp-edged objects in the storage nets or the net, otherwise there is an increased risk of injury in an accident. ◀

Clothes hooks

Clothes hooks are located near the grab handles in the rear.

 When hanging clothing on the hooks, ensure that it will not obstruct the driver's vision. Do not hang heavy objects on the hooks. If you do so, they could cause personal injury to occupants during braking or evasive maneuvers. ◀

Cup holders

! Use lightweight, unbreakable containers and do not transport hot beverages. Otherwise, there is an increased risk of injury in the event of an accident. Do not force containers that are too large into the cup holders, otherwise damage could result. ◀

Opening

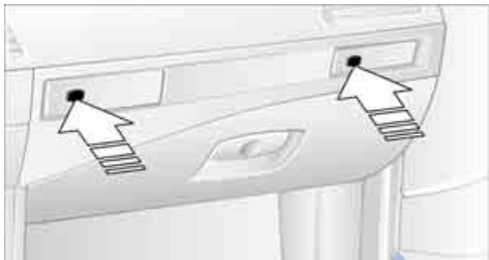

Briefly press the button.

Closing

Press the cover in the center and push in the cup holder.

Ashtray, front

Opening

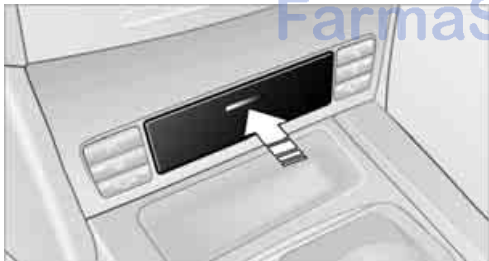

Briefly press the center of the cover.

Emptying

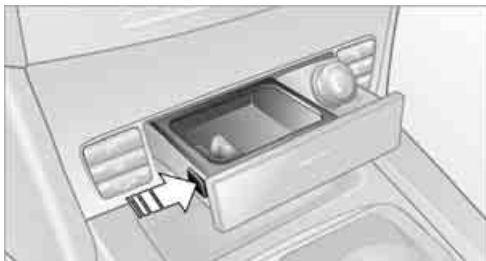

Press the button, refer to arrow. The ashtray rises and can be removed.

Cigarette lighter, front

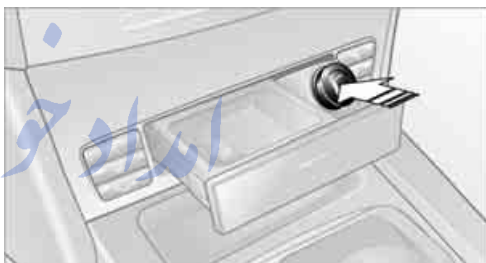

Press in the lighter with the engine running or the ignition switched on.

The lighter can be removed as soon as it pops back out.

! Hold or touch the hot cigarette lighter by the knob only. Holding or touching it in other areas could result in burns. Always take along the remote control when you leave the vehicle, otherwise children could, for example, use the lighter and burn themselves. ◀

Ashtray, rear

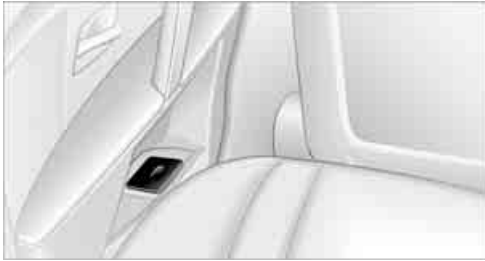

Emptying

Press the entire cover down. The ashtray rises and can be removed.

Cigarette lighter, rear

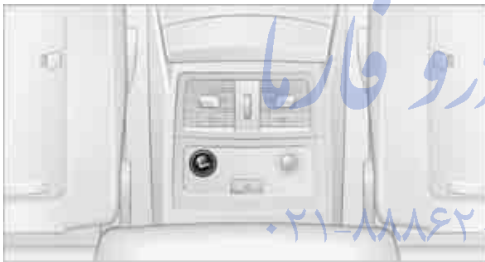

Refer to Cigarette lighter, front.

Connecting electrical devices

Sockets

With the engine running or the ignition switched on, the cigarette lighter socket can be used as a power outlet for hand flashlights, car vacuum cleaners, etc., with power ratings of up to approx. 200 W at 12 V. Avoid damaging the socket due to inserting plugs of different shapes or sizes. The same is true for all power outlets in the vehicle.

In front passenger footwell



Access to socket:
Fold open the cover.

Sedan: In cargo bay

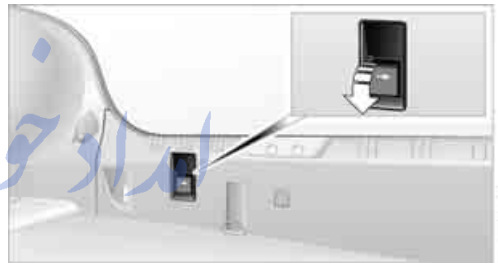

Access to socket:
Fold open the cover.

Sports Wagon: In cargo bay

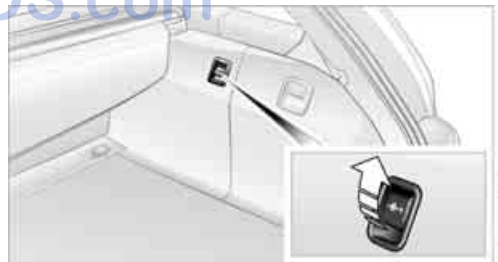

Access to socket:
Fold open the cover.

In rear center console



Depending on the equipment, the sockets in the rear are covered with caps or equipped with a lighter. Refer to Cigarette lighter, front, page 125.

Access to socket:

Remove respective cap or lighter.

at the end of the belt into the socket provided for it on the rear window shelf.

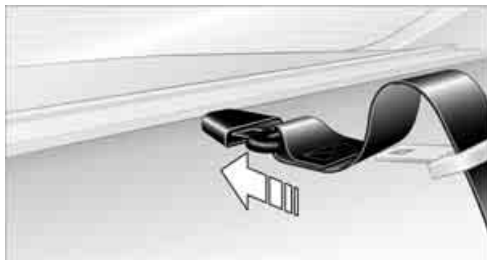

2. Push the corresponding head restraint down as far as it will go, refer to page 52.
3. To release the rear backrest, pull the corresponding lever in the cargo bay.

Center armrest, rear



Storage tray:

Pull the cover upward, arrow 1.

Access to cup holders:

Press button 2 and open the cover.

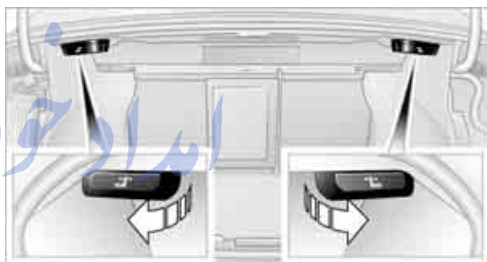

4. The unlocked rear backrest moves forward slightly. Fold the backrest forward by the head restraint.

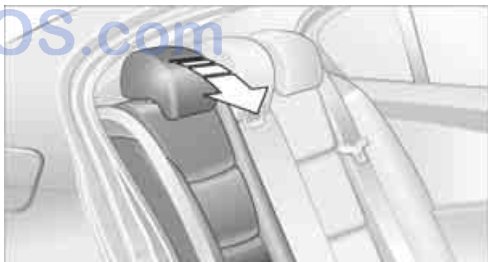

Sedan: Through-loading system*

Opening

1. Release the buckle of the center seat belt in the rear seat using the latch plate of one of the other safety belts. Insert the latch plate

Closing

1. Fold the rear backrest into the seating position and engage.

 When you return the seat to its upright position, make sure that the catch engages properly. If it is not properly engaged, transported cargo could enter the vehicle dur-

ing braking or evasive maneuvers and endanger the vehicle occupants. ◀

2. Release the latch plate from the bracket on the rear window shelf and insert it into the buckle of the center safety belt. Make sure the latch plate audibly engages.

The lashing eyes in the cargo bay provide you with a way to attach cargo-bay nets* or luggage straps for securing suitcases and luggage, refer to page 138.

Sports Wagon: cargo bay

Roll-up cover

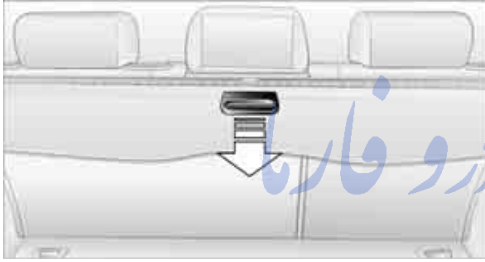

Pull out the roll-up cover and hook it into the brackets.

! Do not place heavy or hard objects on the roll-up cover. If you do so, they may pose a danger to vehicle occupants during braking or evasive maneuvers.

Do not allow the roll-up cover to snap back, otherwise it can be damaged. ◀

Manual roll-up cover

When opening the tailgate or rear window, the roll-up cover is raised. Before closing the tailgate and rear window, press down the roll-up cover until it engages.

Automatic roll-up cover*

When the tailgate or rear window are opened, the roll-up cover is raised, and when the tailgate and rear window are closed, it is lowered.

! Make sure that the closing area of the roll-up cover is clear of obstructions, other-

wise the payload or the roll-up cover may be damaged. ◀

Expanding cargo bay

The rear backrest is divided. You can fold down both sides separately in order to expand the cargo bay.



Reach into the recess and pull toward the front.

! When you fold back the backrest, be sure that the catch engages securely. The red warning indicator disappears in the recess when the catch is engaged. If it is not properly engaged, transported cargo could enter the passenger compartment during braking or evasive maneuvers and endanger the vehicle occupants. ◀

! To ensure that the safety systems continue to provide optimized protection, please observe the safety belt information on page 47. ◀

Partition net

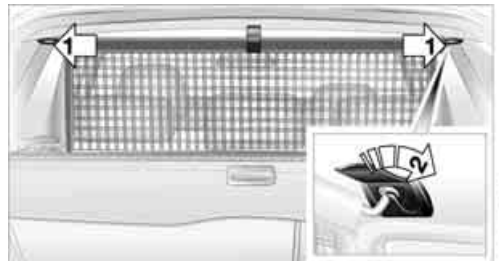

! Do not allow the partition net to snap back, otherwise there is a risk of injury and the partition net may be damaged. ◀

With normal cargo bay

Pull the partition net out of the case by the loop. Grasp the rod on both sides and insert it in the brackets, arrow 1. This is best carried out from the rear seat.

When you no longer require the partition net, grasp the rod on both sides and remove it from the brackets, arrow 2. Then slowly allow the partition net to glide into the case.

With an expanded cargo bay

1. Fold down both rear backrests, refer to Expanding cargo bay.
2. Unlock the case on both sides with the buttons, arrow 1.

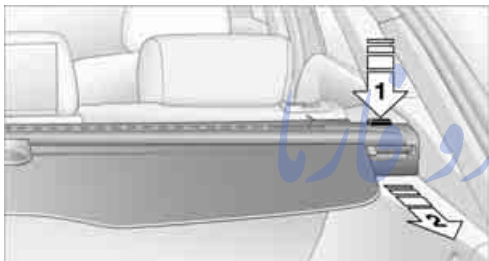

3. Pull out the case downward, arrow 2; avoid tilting when doing so.



4. Push the case into the guides on the backs of the backrests.
5. Carefully pull out the partition net and insert it in the front brackets as described in With normal cargo bay. This is best carried out from the front seat.

To restore the original state, proceed in the reverse order. Finally, lay the case in the two side brackets and then press forward until it engages. The red warning indicator disappears

in the recess when the catch is engaged. Check whether the case is properly locked in place by pulling it with a sudden movement.

Compartment in floor

Automatic roll-up cover: the opened floor panel strikes against the roll-up cover in the end position. If necessary, unhook the roll-up cover at the rear before opening the floor panel.

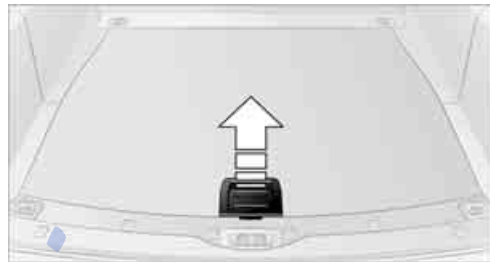

To open, reach into the recess and swing up the handle.

The floor panel flap can be locked.

The partitions in the compartment can be rearranged.

Folding up spare tire cover

1. Swing up the cover.



2. Detach the hook from the bracket and hook into the floor panel flap.

Before swinging down, return the hook to its original position.

Storage area package*

Retaining straps

You can unhook the right-hand retaining strap, e.g. to open the side panel. To unhook at the

rear end, pull downward; to hook in, press it into the opening. In addition, it can also be secured in the center. This makes it possible to secure objects of different sizes.

Hooks

Two hooks can be used to secure smaller objects.

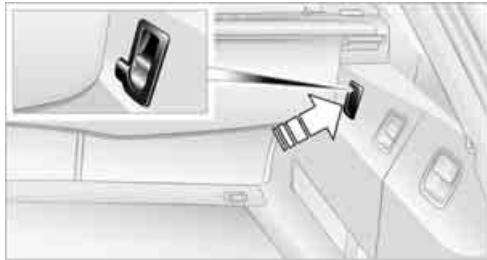

Press at bottom and fold out until they lock.

Compartments in floor

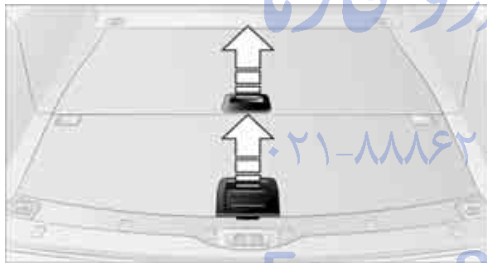

Front compartment:

To open the flap, pull upward on the handle.

To close the flap, press downward until it locks.

Rear compartment:

To open, reach into the recess and swing up the handle.

The rear flap can be locked.

Dividing up rear compartment

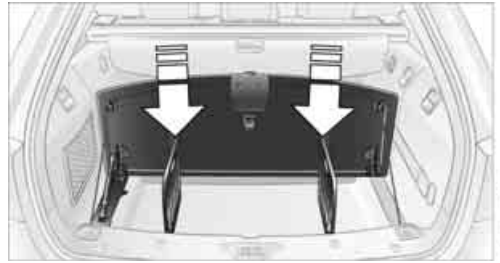

Fold out the partitions and press down.

! Use the partition net, refer to page 128. Otherwise objects could be thrown around and endanger occupants, e.g. during braking or evasive maneuvers. ◀

Ski bag*

The ski bag is designed for safe, clean transport of up to 4 pairs of standard skis or up to 2 snowboards.

With the ski bag you can stow skis with a length of up to 6.9 ft/2.10 m. When skis of 6.9 ft/2.10 m in length are loaded, the ski bag will tend to contract, reducing its overall capacity.

Loading

1. Fold down the center armrest, press the button and open the cover.

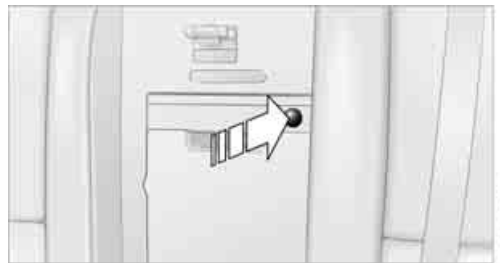

2. Press the button again; the cover in the cargo bay opens. If you press the button firmly the first time, this also opens the cover in the cargo bay.
3. Extend the ski bag between the front seats and fill it. The zipper facilitates access to the stowed items and drying of the ski bag.

4. Insert the latch plate of the ski bag retaining strap into the center safety belt buckle that is marked CENTER.



Only stow clean skis in the ski bag. Wrap sharp edges to prevent damage.

Securing cargo

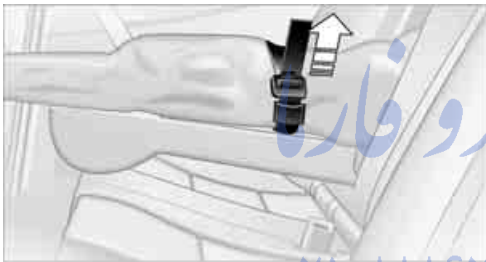

After loading, secure the ski bag and its contents. Tighten the retaining strap on the tensioning buckle for this purpose.

 Secure the ski bag in this way. If you fail to do so, it could endanger vehicle occupants during braking or evasive maneuvers. ◀

To store the ski bag, perform the above steps in reverse order.

Removing ski bag

The ski bag can be completely removed, e.g. for faster drying or to allow you to put it to other uses.



1. Pull the handle forward and pull the ski bag up and out.
2. Close the cover in the cargo bay.

 Your BMW center will be glad to provide you with more detailed information on the various items of equipment. ◀



امداد خودرو فارما

تلفن شبانه روزی: ۰۲۱-۸۸۸۶۲۰۸۵

FarmaSOS.com

Driving tips

This section provides you with information useful in dealing with specific driving and operating conditions.

امداد خودرو فارما

تلفن شبانه روزی: ۰۲۱-۸۸۸۶۲۰۸۵

FarmaSOS.com

Things to remember when driving

Break-in period

Moving parts need breaking-in time to adjust to each other. To ensure that your vehicle continues to provide optimized economy of operation throughout an extended service life, we request that you devote careful attention to the following section.

Engine and differential

Always obey all official speed limits.

Up to 1,200 miles/2,000 km

Drive at changing engine and driving speeds, however do not exceed 4,500 rpm or 100 mph/160 km/h.

Avoid full-throttle operation and use of the transmission's kick-down mode during these initial miles.

From 1,200 miles/2,000 km

The engine and vehicle speed can gradually be increased.

Tires

Due to technical factors associated with their manufacture, tires do not achieve their full traction potential until after an initial break-in period. Therefore, drive reservedly during the first 200 miles/300 km.

Brake system

Brakes require an initial break-in period of approx. 300 miles/500 km to achieve optimized contact and wear patterns between brake pads and rotors. Drive in a reserved manner during this break-in period.

Clutch

The function of the clutch is only at its optimized level after a distance driven of approx. 300 miles/500 km. During this break-in period, engage the clutch gently.

Following part replacement

Observe the break-in instructions again if components mentioned above must be replaced after subsequent driving operation.

Saving fuel

The fuel consumption of your vehicle depends on various factors. Through a few simple steps, your driving style, and regular maintenance, you can have a positive influence on your fuel consumption and environmental impact.

Removing unnecessary cargo

Additional weight increases fuel consumption.

Removing add-on parts after use

Remove unneeded auxiliary mirrors, roof or rear luggage racks after use. Add-on parts attached to the vehicle impede the aerodynamics and increase the fuel consumption.

Closing windows and glass sunroof

An open glass sunroof or open windows likewise increase the drag coefficient and therefore the fuel consumption.

Checking tire inflation pressures regularly

Check and correct the tire inflation pressure as needed at least twice a month and before long trips.

An insufficient tire inflation pressure increases the rolling resistance and thus increases the fuel consumption and tire wear.

Driving off immediately

Do not allow the engine to warm up by leaving it running while the vehicle remains stationary. Instead, begin to drive at a moderate engine speed. This is the fastest way for the cold engine to reach its operating temperature.

Thinking ahead when driving

Avoid unnecessary acceleration and braking. To do so, maintain the appropriate distance from the vehicle in front of you. An anticipatory and smooth driving style reduces fuel consumption.

Avoiding high engine speeds

Use 1st gear only for starting off. Accelerate rapidly in 2nd gear and above. Avoid high engine speeds in doing so and shift into the next gear early.

When you have reached the desired speed, shift into the highest possible gear and drive with the lowest possible engine speed while maintaining a constant a vehicle speed.

In general: driving at a low engine speed reduces fuel consumption and minimizes wear.

Taking advantage of coasting

When approaching a red light, let off the gas and allow the vehicle to coast to a stop in the highest possible gear.

On steep roadways, let off the gas and allow the vehicle to roll in the appropriate gear.

The flow of fuel is interrupted when coasting.

Switching off the engine during longer stops

Switch off the engine at longer stops such as traffic signals, railroad crossings, or in traffic jams. Even having the engine switched off for approx. 4 seconds results in fuel savings.

Switching off functions currently not required

Functions such as the cooling function of the automatic climate control, seat heating or rear window defroster draw large amounts of power and consume additional fuel. Their influence is particularly pronounced in city traffic and stop & go operation. For this reason, it is a good idea to switch these functions off when they are not really needed.

Having maintenance carried out

Have the vehicle serviced regularly in order to achieve the optimum economy and service life of your vehicle. BMW recommends having the maintenance performed by a BMW center. Also please pay attention to the BMW maintenance system, refer to page 237.

General driving notes

Closing luggage compartment lid/ tailgate

 Operate the vehicle only when the luggage compartment lid/tailgate is completely closed. Otherwise, exhaust fumes could enter the interior of the vehicle. ◀

If it is absolutely necessary to drive with the luggage compartment lid open:

1. Close all windows and the glass sunroof or panorama glass sunroof.
2. Increase the air volume of the automatic climate control to a high level, refer to page 116.

Hot exhaust system

 As in all vehicles, extremely high temperatures are generated on the exhaust system. Do not remove the heat shields installed adjacent to it, and never apply undercoating to them. When driving, standing at idle and while parking take care to avoid possible contact between the hot exhaust system and any highly flammable materials such as hay, leaves, grass, etc. Such contact could lead to a fire, and with it the risk of serious property damage as well as personal injury. Do not touch hot exhaust tail pipes. Otherwise there is a risk of burns. ◀

Hydroplaning

 When driving on wet or slushy roads, reduce road speed. If you do not, a wedge of water can form between tires and road surface. This phenomenon is referred to as hydroplaning, and is characterized by a partial or complete loss of contact between the tires and

the road surface, ultimately undermining your ability to steer and brake the vehicle. ◀

The risk of hydroplaning increases as the tread depth of the tires decreases, refer also to Minimum tire tread on page 229.

Driving through water

 Do not drive through water on the road if it is deeper than 1 ft/30 cm, and then only at walking speed at the most. Otherwise, the vehicle's engine, the electrical systems and the transmission may be damaged. ◀

Using handbrake on inclines

 On inclines, do not hold the vehicle in place for a long time by riding the clutch; use the handbrake. Otherwise greater clutch wear will result. ◀

Braking safely

Your BMW is equipped with ABS as a standard feature. In situations that require it, it is best to brake with full force. Since the vehicle maintains steering responsiveness, you can still avoid possible obstacles with a minimum of steering effort.

Pulsation of the brake pedal, combined with sounds from the hydraulic circuits, indicate that ABS is in its active mode.

 Do not drive with your foot resting on the brake pedal. Even light but consistent pedal pressure can lead to high temperatures, brake wear and possibly even brake failure. ◀

Driving in wet conditions

When roads are wet or there is heavy rain, briefly exert gentle pressure on the brake pedal every few miles. Monitor traffic conditions to ensure that this maneuver does not endanger other road users. The heat generated in this process helps dry the pads and rotors to ensure that full braking efficiency will then be available when you need it.

Hills

 To prevent overheating and the resulting reduced efficiency of the brake system,

drive long or steep downhill gradients in the gear in which the least braking is required. Even light but consistent pressure on the brake can lead to high temperatures, brake wear and possibly even brake failure. ◀

The braking effect of the engine can be further increased by downshifting, if necessary all the way down into first gear. This strategy helps you avoid placing excessive loads on the brake system. For information on downshifting in the manual mode of the automatic transmission, refer to page 65.

 Do not drive with the clutch depressed, in idle or with the engine switched off, otherwise there will be no engine braking action or support of the braking force and steering. Never allow floor mats, carpets or any other objects to protrude into the area of movement of the pedals and impair their operation. ◀

Corrosion on brake rotors

When the vehicle is driven only occasionally, during extended periods when the vehicle is not used at all, and in operating conditions where brake applications are less frequent, there is an increased tendency for corrosion to form on rotors, while contaminants accumulate on the brake pads. This occurs because the minimum pressure which must be exerted by the pads during brake applications to clean the rotors is not reached.

Should corrosion form on the brake rotors, the brakes will tend to respond with a pulsating effect that even extended application will fail to cure.

When vehicle is parked

Condensation forms in the air conditioner system during operation, and then exits under the vehicle. Traces of condensed water under the vehicle are therefore normal.

Before driving into a car wash

Fold in the exterior mirrors, refer to page 55, otherwise they could be damaged due to the width of the vehicle.

You can find valuable information on this topic under Care, starting on page 239.

528i xDrive, 535i xDrive

 Avoid car washes with guide rail heights over 4 in/10 cm; otherwise, there is a danger of damaging chassis parts. ◀

Rear window wiper*

The rear window wiper can be damaged in car washes. Take appropriate protective measures; ask the car wash operator if necessary.

Automatic and sport automatic transmission

Follow the instructions on page 63 so that the vehicle can roll.

Cargo loading

 To avoid loading the tires beyond their approved carrying capacity, never overload the vehicle. Overloading can lead to overheating and increases the rate at which damage develops inside the tires. The ultimate result can assume the form of a sudden blow-out. ◀

 Make sure that no fluids leak in the cargo bay; otherwise the vehicle could be damaged. ◀

Determining loading limit



1. Locate the following statement on your vehicle's placard*:

 The combined weight of occupants and cargo should never exceed XXX lbs. or YYY kg, as otherwise the vehicle

may be damaged and unstable driving conditions may result. ◀

2. Determine the combined weight of the driver and passengers that will be riding in your vehicle.
3. Subtract the combined weight of the driver and passengers from XXX lbs. or YYY kg.
4. The resulting figure equals the available amount of cargo and luggage load capacity. For example, if the XXX amount equals 1,400 lbs. and there will be five 150-lb. passengers in your vehicle, the amount of available cargo and luggage load capacity is 650 lbs.:
1,400 lbs. minus 750 lbs. = 650 lbs.
5. Determine the combined weight of luggage and cargo being loaded on the vehicle. That weight may not safely exceed the available cargo and luggage load capacity calculated in step 4.
6. If your vehicle will be towing a trailer, part of the load from your trailer will be transferred to your vehicle. Consult the manual for transporting a trailer to determine how this may reduce the available cargo and luggage load capacity of your vehicle.

Load

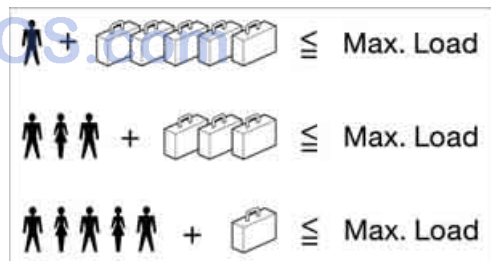

The permissible load is the total of the weight of occupants and cargo/luggage. The greater the weight of occupants, the less cargo/luggage can be transported.

Stowing cargo

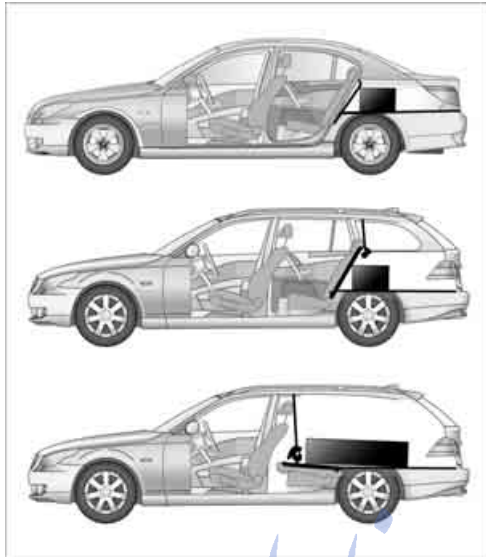

- ▷ Load heavy cargo as far forward and as low as possible, placing it directly behind the rear backrest.
- ▷ Cover sharp edges and corners.
- ▷ For very heavy cargo when the rear seat is not occupied, secure each safety belt in the opposite buckle.
- ▷ Do not pile objects higher than the top edge of the backrest.
- ▷ Sports Wagon: Use the partition net to protect the occupants, refer to page 128. Make sure that objects cannot penetrate through the partition net. Wrap sharp-edged or pointed objects which could strike the rear window while driving.

Securing cargo

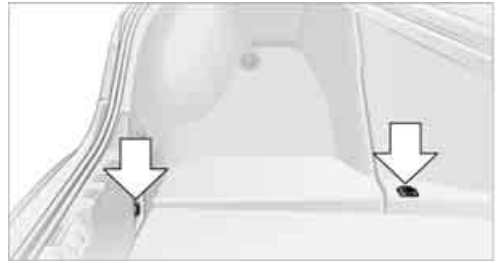

- ▷ Use the luggage net*, luggage straps, or securing straps to hold down small and lightweight luggage and cargo.
- ▷ Heavy-duty cargo straps* for securing larger and heavier objects are available at your BMW center. Four lashing eyes mounted in the cargo bay are used to secure these heavy-duty cargo straps, refer to illustration.
- ▷ Please observe the special instructions supplied with the heavy-duty cargo straps.

 Position and secure the cargo as described above, so that it cannot endanger the vehicle's occupants, for example if sudden braking or evasive maneuvers are necessary. تلفن شبانه روزی

Never exceed either the approved gross vehicle weight or either of the approved axle loads, refer to page 263, as excessive loads can pose a safety hazard, and may also place you in violation of traffic safety laws.

You should never transport unsecured heavy or hard objects in the passenger compartment, as they could fly around and pose a safety hazard to the vehicle's occupants during abrupt braking or evasive maneuvers.

Use only the lashing eyes pictured to fasten the heavy-duty cargo straps. Do not secure cargo with the upper attachment points for LATCH, refer to page 59; otherwise, you could damage them. ◀

Roof-mounted luggage rack*

A special rack system is available as an option for your BMW. Please comply with the precautions included with the installation instructions.

Mounting points



The mounting points are located in the door openings or on the roof rails*.

Loading roof-mounted luggage rack

Because roof racks raise the vehicle's center of gravity when loaded, they have a major effect on its handling and steering response.

You should therefore always remember not to exceed the approved roof load capacity, the approved gross vehicle weight or the axle loads when loading the rack.

You can find the specified weights under Weights on page 263.

Distribute the roof load uniformly. The load must not be too large in area. Always stow the heaviest pieces on the bottom. Be sure that adequate clearance is maintained for raising the glass sunroof, and that objects do not project into the opening path of the luggage compartment lid/tailgate.

Secure roof-mounted cargo correctly and securely to prevent it from shifting or falling off during the trip.

Drive smoothly. Avoid sudden acceleration and braking maneuvers. Take corners gently.



امداد خودرو فارما

تلفن شبانه روزی: ۰۲۱-۸۸۸۶۲۰۸۵

FarmaSOS.com

Navigation

This chapter describes how to enter destinations and specify your route so that the navigation system can guide you reliably to your destination.

امداد خودرو فارما

تلفن شبانه روزی: ۰۸۵-۸۸۸۶۲۰۲۱

FarmaSOS.com

Starting navigation system*

Your navigation system can use satellites to ascertain the precise position of your vehicle and guide you reliably to any destination you enter.

Navigation DVD

The navigation system requires a special navigation DVD. The latest version is available at your BMW center.

Inserting navigation DVD



1. Insert the navigation DVD with the labeled side up. The navigation DVD is retracted.
2. Allow several seconds for the system to scan the data from the DVD.

Removing navigation DVD

1. Press  button **1**.
The DVD emerges slightly from the drive.
2. Remove the DVD.

If the DVD is not ejected from the drive, it is possible that it is blocked. In this case a message is also shown on the Control Display.

Display in assistance window

You can display the route or the current position in the assistance window. This display remains visible even if you change to another application.

1. Move the controller to the right to enter the assistance window.



2. Press the controller. Other menu items are displayed.
3. Select the desired route view or "Current position".



4. Press the controller.

Displaying arrow view in map view*

If the navigation system suggests a change of direction, the arrow view is briefly displayed.

1. Press the **MENU** button.
This opens the start menu.
2. Press the controller to open the **i** menu.
3. Turn the controller until "Settings" is selected and press the controller.

4. Turn the controller until "Language / Units" is selected and press the controller.
5. Change to upper field if necessary. Turn the controller until "Languages" is selected and press the controller.
6. Select "Arrow display pop-up instructions" and press the controller.

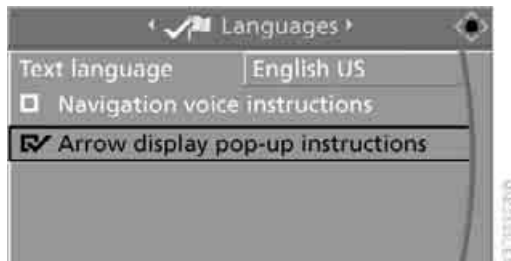

The arrow view appears in the assistance window.

امداد خودرو فارما

تلفن شبانه روزی: ۰۲۱-۸۸۸۶۲۰۸۵

FarmaSOS.com

Destination entry

In entering your destination you can select from among the following options:

- ▷ Entering a destination manually, see below
- ▷ Entering destination via voice*, refer to page 147
- ▷ Selecting destination using information, refer to page 150
- ▷ Selecting destination from a list, refer to Destination list, page 151
- ▷ Selecting destination from address book, refer to page 152
- ▷ Selecting home address, refer to page 154

After selecting your destination you can proceed to start the destination guidance, refer to page 156.

You can also store a navigation destination on the programmable memory buttons, refer to page 22.

 Enter data only when the vehicle is stationary, and always give priority to the applicable traffic regulations in the event of any contradiction between traffic and road conditions and the instructions issued by the navigation system. If you do not observe this precaution, you can endanger the vehicle occupants and other road users. ◀

iDrive, for operating principle refer to page 16.

1. Press the **MENU** button.
This opens the start menu.
2. Move the controller to the right to open "Navigation".
3. Select "Navigation" and press the controller.

The Control Display shows:

- ▷ the arrow view or map view during destination guidance
- ▷ the destination list when destination guidance is switched off

Entering a destination manually

The system's word matching principle makes it easier for you to enter the names of streets or towns, refer to page 155. This allows you to enter different spellings and completes your entry so that stored names can be called up quickly.

1. Change to upper field if necessary. Turn the controller until "Navigation" is selected and press the controller.
"New destination" is selected.
2. Press the controller.

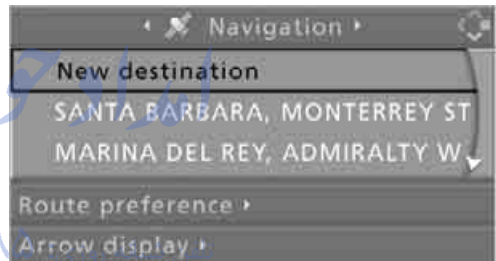

3. Select "Enter address" and press the controller.



The system also supports you with the following features:

- ▷ If you do not enter a street, the system will guide you to the downtown area of a town/city.
- ▷ You can skip the entry of country and locality if the current entries should be retained for your new destination.

Selecting country

1. Select "State / Province" or the displayed country and press the controller.



The list of available countries appears on the display.

2. Select the country of destination and press the controller.

In order to be able to start the destination guidance, at least the town/city of the destination or its zip code must be entered.



Entering destination via town/city name

1. Select "Town / City" or the displayed town/city and press the controller.
2. Select the starting letter and press controller.

A list of all towns/cities starting with this letter appears on the Control Display.

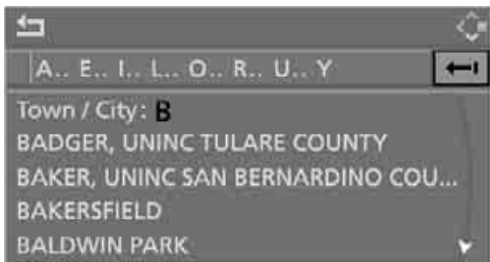
3. To delete the letter entered if necessary:



- ▷ Delete individual numbers or letters: Move the controller toward the right to select , and press the controller.
- ▷ Delete all numbers or letters: Move the controller toward the right to select  and press and hold the controller.

4. If necessary, enter more letters. The list gradually grows smaller each time you enter a new letter.
 - ▷ Enter blank space if necessary: Select the _ symbol and press the controller.



5. Change to the third field from the top if necessary. Turn the controller until the town/city name is selected from the list and press the controller.

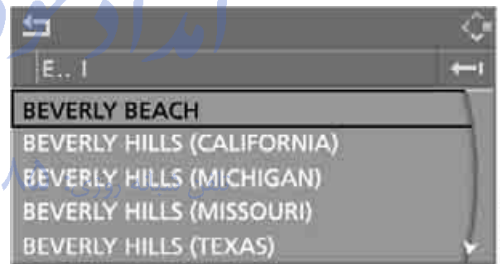

Entering destination by zip code

1. Select "Town / City" and press the controller.
2. Enter the zip code:
Select the desired digits and press the controller.



- ▶ Enter a blank space:
Select the _ symbol and press the controller.
 - ▶ Delete individual numbers or letters:
Move the controller toward the right to select ← and press the controller.
 - ▶ Delete all numbers or letters:
Move the controller toward the right to select ← and press and hold the controller.
3. Select the zip code and press the controller.
The corresponding destination is displayed.
 4. Change into the third field from the top.
Turn the controller until the destination is selected and press the controller.

Entering street, house number and intersection

After the street you can also enter the intersection or the house number.

Entering street and intersection

1. Select "Street" or the street displayed and press the controller.
2. Enter the street.
The street is entered exactly like the destination.



The intersection is entered in the same way as the street.

Entering a street without entering destination

You can also enter a street without entering a destination. In this case all streets of the entered country are offered for selection. The related town/city is displayed after the street name.

If a town/city has already been entered, you can undo this entry. This may be practical if the desired street does not exist in the entered destination, because, for example, it belongs to another part of the town/city.

1. Change to upper field.
← The arrow is selected.



- Turn the controller to the right until the request for the entry of a street in the country appears and press the controller.

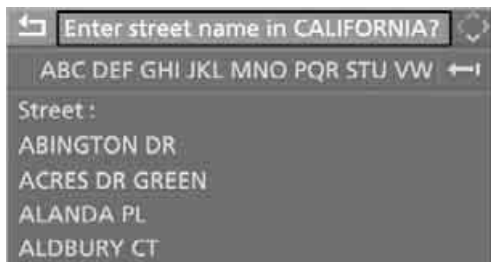

- Change to the second field from the top and enter the street.

Entering house number

All house numbers stored for the street on the navigation DVD can be entered.

- Select "House number" and press the controller.
- Enter the house number: Select the desired digits and press the controller.
- Change into the third field from the top. Turn the controller until the house number is selected and press the controller.

Starting destination guidance with manual destination entry

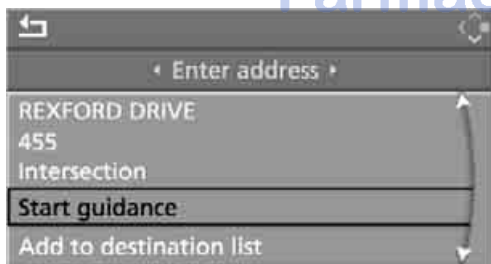

- Select "Start guidance" and press the controller. Destination guidance starts immediately.
- If the destination guidance does not need to be started immediately: Select "Add to destination list" and press the controller.

The destination is stored in the destination list, refer to page 151.

Entering destination via voice*

You can enter a desired destination via the voice command system. When entering the destination, it is possible to change between voice command and iDrive at any time. Reactivate the voice command function for this purpose if necessary.



With ›Options‹ you can have the possible commands read aloud. ◀

- Press the  button on the steering wheel.
- ›Enter address‹



Selecting country

- Wait for the system to ask for the country of destination.
- Say the name of the country of destination.

Say the name of the country of destination in the language of the voice command system.

Entering destination

The destination can be spelled or entered as an entire word.

Spelling destination

To enter the destination, spell it using the orthography of the country of destination. Pronounce the letters smoothly and at normal

volume, avoiding excessive emphasis and pauses.

1. Spell town/city name:
Say at least the first three letters of the destination. The more letters you say, the more exactly the system recognizes the town/city.

The system can suggest up to 20 destinations that match your entries. Up to 6 entries are displayed at once on the Control Display.



A destination is suggested by the system.

2. Select town/city:
 - ▶ Select highlighted town/city: ›Yes‹
 - ▶ Select other town/city: ›No‹
 - ▶ Select entry, e.g. ›Entry 3‹
 - ▶ To show other entries in the list: ›Next page‹
 - ▶ To respell the town/city: ›Repeat‹

The town/city can also be selected from the list via iDrive:

Turn the controller until the destination is selected and press the controller.

Entering the destination as an entire word*

Towns/cities and streets located in the region where the language of the voice command system is spoken can be entered as an entire word.

Example: to enter a US destination as an entire word, the system language must be English.

Speak smoothly and at normal volume, avoiding excessive emphasis and pauses.

1. Wait for the system to request the destination.

2. Say the name of the destination.

The system can suggest up to 6 destinations that match your entries.



A destination is suggested by the system.

3. Select town/city:
 - ▶ Select highlighted town/city: ›Yes‹
 - ▶ Select other town/city: ›No‹
 - ▶ Select entry, e.g. ›Entry 3‹
 - ▶ To reenter the town/city: ›Repeat‹
 - ▶ To enter the town/city by spelling: ›Spell‹

The town/city can also be selected from the list via iDrive: تلفن شبانه

Turn the controller until the destination is selected and press the controller.

▶ Destinations that sound the same which cannot be differentiated by the system are summarized in a separate list and shown as a destination followed by three dots. Select this entry with ›Yes‹ if necessary. Then select the desired town/city from this list. ◀

Entering street and house number

The street is entered in the same way as the destination.

To enter the house number:

1. ›House number‹
2. Say the house number.

Up to 4-digit house numbers can be entered. Say the house number as individual numbers.



Starting destination guidance

 ›Start guidance◀

Destination guidance starts immediately.

Saving destination

The destination is added to the destination list or can be stored in the address book.

 ›Add to destination list◀ or
 ›Add to address book◀

Map-guided destination selection

If you only know the location of the town/city or street of the destination, then you can enter the destination by using a map. You can use the cursor to select the destination on the map and then adopt it into the destination guidance.

1. Select "Navigation" and press the controller.
"New destination" is selected.
2. Press the controller.

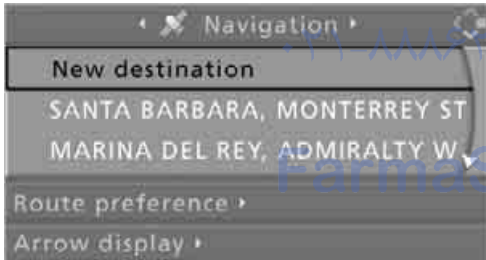

3. Select "Input map" and press the controller.

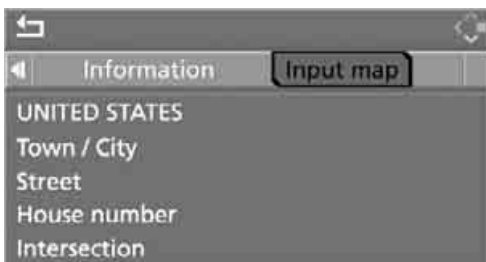

A section of a map is displayed on the Control Display:

- ▶ During destination guidance, around the current destination
- ▶ With the destination guidance deactivated, around the last destination entered



4. Select destination with cursor.
 - ▶ Changing scale: turn the controller.
 - ▶ Moving map: move the controller in the required direction.
The controller can be moved to the left, right, forwards and backwards.
5. To adopt or store the destination in the destination guidance system, press the controller.
The selected destination and other menu items are displayed.

6. Select the desired menu item:
 - ▷ "Start route guidance" starts destination guidance.
 - ▷ "Show current position" places your current position at the center of the map.
 - ▷ "Show destination position" places the current destination at the center of the map.
 - ▷ "Return to map" changes back to the "Input map".
 - ▷  Exit the menu.

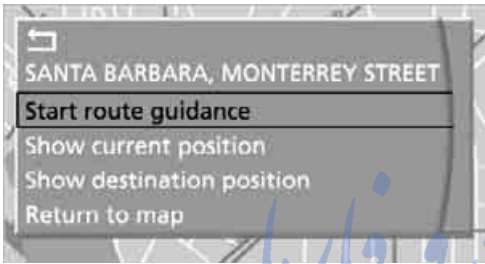

7. Press the controller.

The map for the destination entry can also be displayed in the map display:
Select the  symbol and press the controller.

Selecting destination using information

You can obtain a display of selected destinations, e.g. hotels, sights or hospitals, and adopt them into the destination guidance.

1. Select "Navigation" and press the controller.
2. Select "Information" and press the controller.

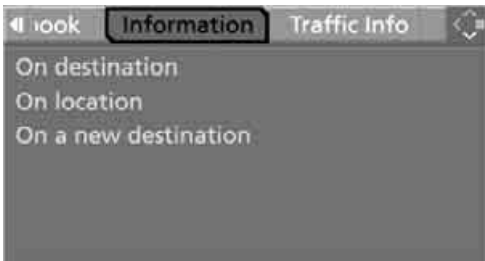



3. Select location:
 - ▷ "On destination"
 - ▷ "On location"
 - ▷ "On a new destination"



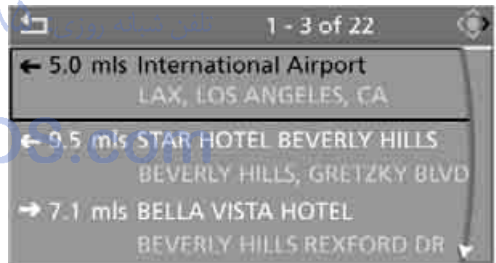

4. Press the controller.
5. Make your selection, e.g. "Hotels and restaurants", and press the controller.
6. Enter search criteria if necessary, e.g. the maximum distance from the current location.
7. Select "<Start search>" and press the controller.
These destinations are displayed on the Control Display.



8. Select a destination and press the controller.
 The scope of the information and symbols is dependent on the respective navigation DVD.◀
9. Select the desired menu item:
 - ▷ To adopt the address in the destination list and start the destination guidance:

Select the  symbol and press the controller.

- ▷ To establish a telephone connection: Select the  symbol and press the controller.
- ▷ To display additional destinations: Select the  symbol and press the controller.
- ▷ To start a new search: Select the  symbol and press the controller.

To exit the menu:

 Select the arrow and press the controller.

Symbols in map view

If, for example, you have selected the category Hotels, the hotels are shown on the map as symbols.

To hide the symbols in the map view:

1. Select the symbol and press the controller.

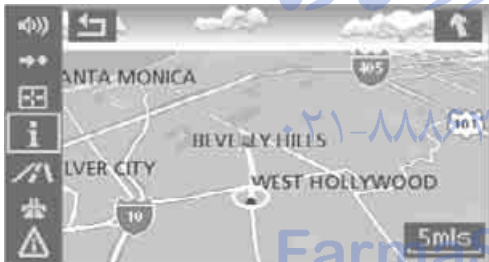

2. Select "Hide map icons" and press the controller.

The symbols are hidden.

To display the symbols:

Select "Show map icons" and press the controller.

To exit the menu:

 Select the arrow and press the controller.

Destination list

The last 20 entered destinations are shown in the destination list. You can display these destinations and adopt them in the destination guidance system.

For example, to plan a longer route, you can store all destinations you want to drive to in advance in the destination list, refer to Entering a destination manually on page 144.

Select "Navigation" and press the controller.



The last destination entered is the first item in the destination list.

 This symbol indicates the current destination during destination guide.

To display additional destinations from the destination list:

Turn the controller.

Applying destination in destination guidance system

1. Select the desired destination and press the controller.
2. Select "Start guidance" and press the controller.

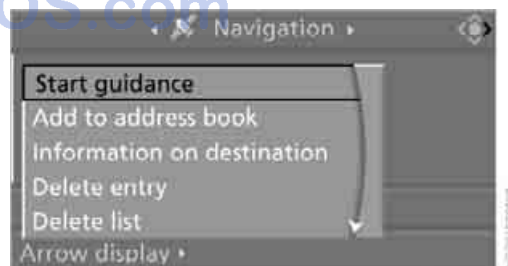

Editing destination list

1. Select the desired destination in the destination list and press the controller.
2. The selected destination can be edited:
 - ▷ Store entry:
Select "Add to address book".
 - ▷ Display information on destination:
Select "Information on destination".
 - ▷ Delete entry:
Select "Delete entry".
 - ▷ Delete all entries:
Select "Delete list". The destination guidance is switched off.
 - ▷ Change entry:
Select "Edit". For operation, refer to Entering destination via town/city name, page 145.
3. Press the controller.

Address book

Opening address book

iDrive, for operating principle refer to page 16.

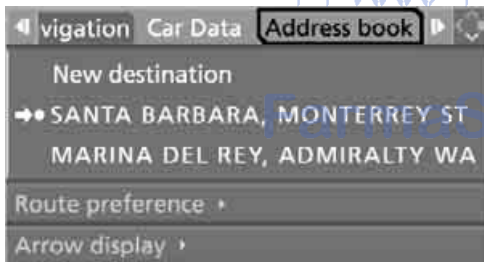

Select "Address book" and press the controller.

Storing destinations in address book

You can store approx. 100 destinations in the address book.

1. Select "Address book" and press the controller.
2. Select "New address" and press the controller.

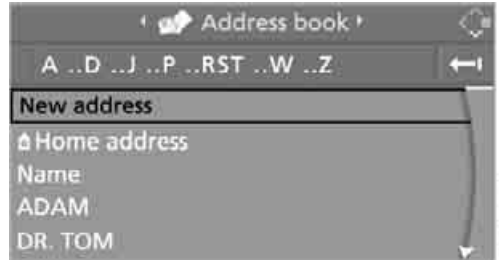

3. Select "Enter address" and press the controller.
4. Enter name and address, also refer to Entering a destination manually, page 144.
5. Select "Store in address book" and press the controller.
The entry is stored in the address book.

You can also store a destination from the destination list in the address book, refer to page 151.

Storing current position*

The current position can be adopted into the address book.

1. Select "Address book" and press the controller.
2. Change into the third field from the top. Turn the controller until "New address" is selected and press the controller.

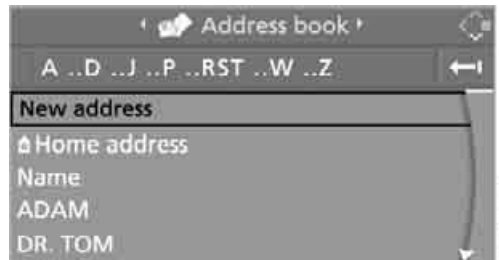

3. Select "Use current location as address" and press the controller.
The name given can be changed. For oper-

ation, refer to Entering a destination manually, page 144.

4. Select "Store in address book" and press the controller.

You can also enter your current position into the address book if you have left the sector covered by the navigation DVD. In this case, you must enter a name.

Selecting destinations from address book

1. Select "Address book" and press the controller. The stored entries appear on the Control Display.

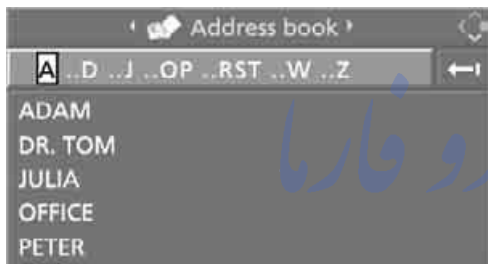

2. Select the entry and press the controller.

To start the destination guidance:
Select "Start guidance" and press the controller.

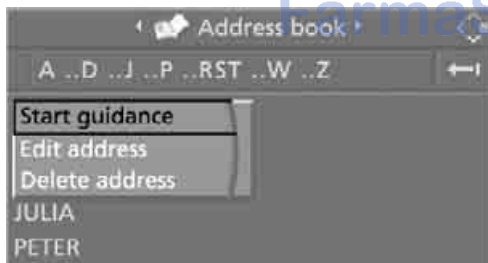

Changing destinations from address book

1. Select "Address book" and press the controller.
2. Select the entry and press the controller.

3. Select "Edit address" and press the controller.



4. Change entry.
For operation, refer to Entering a destination manually, page 144.
5. Select "Store in address book" and press the controller.

Deleting individual destinations from address book

1. Select "Address book" and press the controller.
2. Select the entry and press the controller.
3. Select "Delete address" and press the controller.

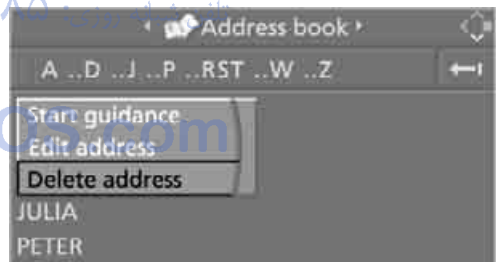

4. Select "Yes" and press the controller.

Deleting all destinations from address book

1. Open the start menu.
2. Press the controller to open the **i** menu.
3. Select "Settings" and press the controller.
4. Select "Vehicle / Tires" and press the controller.

5. Change to upper field if necessary. Turn the controller until "Delete data" is selected and press the controller.



6. Select "Delete address book" and press the controller.
7. Select "Yes" and press the controller.

Storing home address

You can store your current position or the current destination as the home address in the address book. This entry occupies the second position in the address book.

1. Select "Address book" and press the controller.
2. Change into the third field from the top. Turn the controller until "Home address" is selected and press the controller.

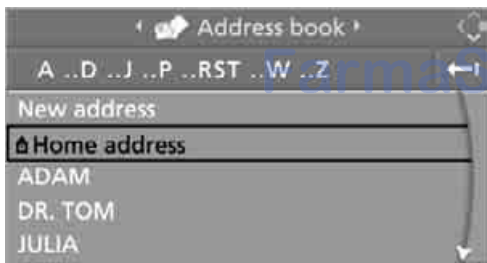

3. Select "Use current location as address", or "Save current destination" during the destination guidance, and press the controller.
4. Select "Store in address book" and press the controller.

Adopting home address as destination

1. Select "Home address" and press the controller.
2. Select "Start guidance" and press the controller.

Changing home address

1. Select "Home address" and press the controller.
2. Select "Edit address" and press the controller. For operation, refer to Entering a destination manually, page 144.

Selecting route

You can influence the calculated route by choosing certain route criteria. You can change the route criteria as often as you like while entering the destination and whenever the destination guidance is active.

The route is planned according to fixed rules. The type of road is taken into account, e.g. whether it is a highway or a winding road. The road types are stored on the navigation DVD. As a result, the routes recommended by the navigation system may not always be the same ones that you would choose based on personal experience.

Changing route criteria

1. Select "Navigation" and press the controller.
2. Change into the third field from the top. Turn the controller until "Route preference" is selected and press the controller.

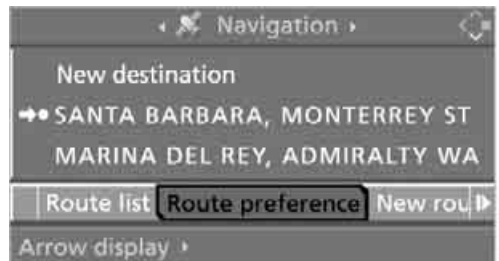

The various criteria are listed on the Control Display.

3. Select a route criterion for the route:
 - ▷ "With highways"
Freeways and major traffic arteries are given priority.
 - ▷ "Avoid highways"
Freeways are avoided where possible.
 - ▷ "Fast route"
Fast route, being a combination of the shortest possible route and the fastest roads.
 - ▷ "Short route"
Short route, irrespective of how fast or slow progress will be.
4. Press the controller.



The route criterion is selected.

5. If necessary, select an additional route criterion and then press the controller:
 - ▷ "Dynamic route"
Automatic rerouting due to traffic obstructions. Depending on road type and the kind and length of the traffic obstruction, the route can also be calculated so that it passes through the traffic obstruction.
 - ▷ "Avoid tollroads"
Tollroads are avoided where possible.
 - ▷ "Avoid ferries"
Ferries are avoided where possible.

To exit the menu:

↩ Select the arrow and press the controller.

The route criteria can also be changed in the arrow or map view:

1. Select the symbol for the route criterion and press the controller.
2. Select a route criterion and press the controller.

▶ If the route criteria "Avoid highways", "Avoid tollroads", or "Avoid ferries" are selected, the calculation time for the route can increase considerably. ◀

Word matching principle

The system supports the word matching principle to make it easier for you to enter the names of streets or towns. The system runs ongoing checks, comparing your destination entries with the data stored on the navigation DVD as the basis for instant response. The user benefits include:

- ▷ Names of specific locations can also vary from the official versions if you are using a spelling that is customary in another country.

Example:

Instead of the German spelling "München" you can also enter the English spelling "Munich" or the Italian spelling "Monaco".

- ▷ When you are entering the names of towns and streets, the system will complete them as soon as enough letters are available to ensure unambiguous identification.
- ▷ The system only accepts name entries beginning with letters that are stored on the navigation DVD. The system will not accept non-existent names and addresses.

Destination guidance

Starting destination guidance

Via iDrive

iDrive, for operating principle refer to page 16.

1. Change to upper field if necessary. Turn the controller until "Navigation" is selected and press the controller.
2. Select a destination from the destination list and press the controller or enter a new destination, refer to page 144.

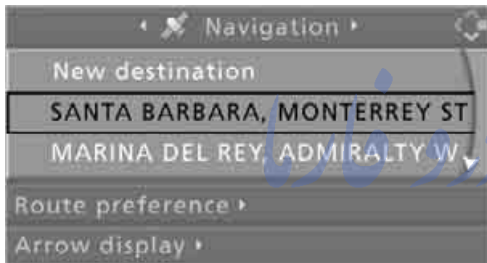

3. Select "Start guidance" and press the controller.

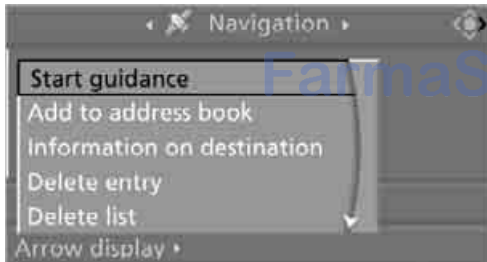

After the route has been calculated, destination guidance is indicated by arrows or a map display on the Control Display.



The destination guidance can also be started in the arrow or map view:

Select the  symbol and press the controller.

During destination guidance, you can operate other equipment via iDrive at any time. You will be punctually notified of a change of direction

by spoken instructions and the display of the direction arrow.

About programmable memory buttons

Press the  ...  button on which the desired destination is stored. Also refer to page 23.

Terminating/continuing destination guidance

In arrow or map display

Select the  symbol and press the controller.

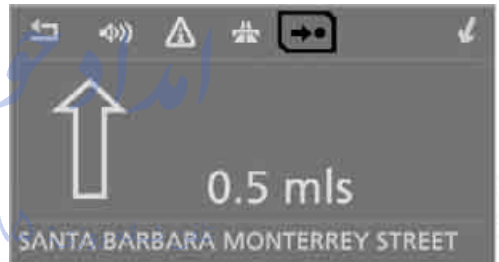

In destination list

 This symbol indicates the current destination.

1. Select the current destination and press the controller.



2. Select "Stop guidance" and press the controller.

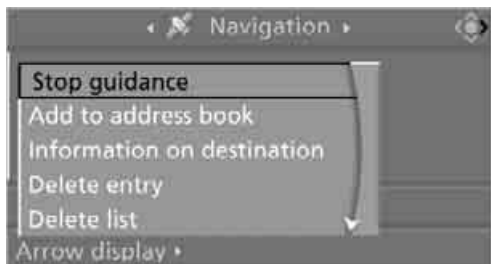

When you park the vehicle before reaching the entered destination, the following question is displayed before beginning the next trip: "Continue guidance to destination?".

The destination guidance starts automatically after a short time.

To start the destination guidance: Select "Yes" and press the controller.

Displaying route

You have the option of displaying various views of the route during destination guidance.

▶ From another menu, you can change directly to the screen last displayed, refer to Comfort opening of menu items, page 19. ◀

Displaying arrow display

1. Select "Navigation" and press the controller.
2. Change into the fourth field from the top. Turn the controller until "Arrow display" is selected and press the controller.



The arrow display is shown.



- 1 Switching voice instructions on/off
- 2 Manually displaying traffic information*
- 3 Selecting route criteria
- 4 Starting/ending destination guidance
- 5 Arrow to destination from a bird's eye view
- 6 Distance to the next change of direction
- 7 Current position
- 8 Direction of travel
 - ▶ Outline arrow: Destination guidance on the calculated route.
 - ▶ Solid arrow: Arrow shows the route to be calculated from a bird's eye view when the vehicle is not located in an area contained on the navigation DVD, e.g. in a parking structure.

Depending on the equipment, the estimated time of arrival and the distance to the destination are displayed in the top or bottom line of the Control Display.

Before a change in direction, the representation of the arrow changes.

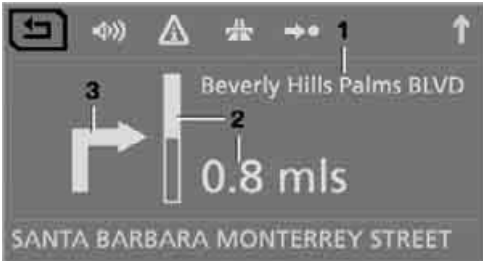

- 1 Street name for change of direction
- 2 Distance up to change of direction
- 3 Change of direction

To exit the menu:

↩ Select the arrow and press the controller.

Displaying map view

You can have your current position displayed on a map. After starting the destination guidance, the planned route is shown on the map.

1. Select "Navigation" and press the controller.
2. Change into the fourth field from the top. Turn the controller until the desired map view is selected:
 - ▷ "Map facing north"
 - ▷ "Map direction of travel"
 - ▷ "Perspective"

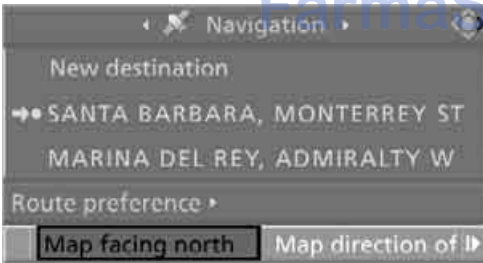

3. Press the controller.



- 1 Switching voice instructions on/off
- 2 Starting/ending destination guidance
- 3 Map-guided destination selection
- 4 Displaying the menu in which the information last selected can be displayed/hidden, refer to Selecting destination via information on page 150
- 5 Changing map display
 - ▷ AN "Map facing north"
 - ▷ V "Map direction of travel"
 - ▷ / "Perspective"
- 6 Changing route criteria
- 7 Manually displaying traffic information*
- 8 Arrow to destination from a bird's eye view

The estimated time of arrival and the distance to the destination are shown in the bottom line of the Control Display.

To exit the menu:

↩ Select the arrow and press the controller.

At scales of less than 250 miles/500 km, you have the option of deciding whether to orient the map to north or toward your current direction of travel. At scales of 250 miles/500 km or greater, the map always points toward north.

Changing map display



Select the corresponding symbol and press the controller.

The next map display is displayed.

Changing scale

Turn the controller to adjust the scale.

Displaying streets and towns/cities of route

You can have the roads and towns along the route displayed during destination guidance.

The distances remaining to be traveled on each individual road are also displayed.

1. Select "Navigation" and press the controller.
2. Change into the third field from the top. Turn the controller until "Route list" is selected and press the controller.

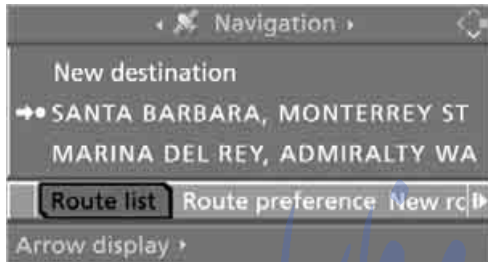

To exit the menu:

1. Select the arrow and press the controller.

Destination guidance via voice instructions

Switching voice instructions on/off

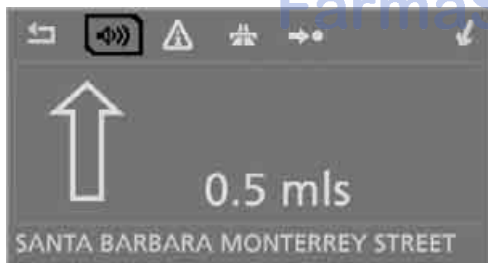

During destination guidance, voice instructions can be switched on or off in the arrow or map view:

1. Select the  symbol and press the controller.

To switch the voice instructions on and off at any time:

1. Press the **MENU** button.
This opens the start menu.
2. Press the controller to open the **i** menu.
3. Turn the controller until "Settings" is selected and press the controller.



4. Turn the controller until "Language / Units" is selected and press the controller.
5. Change to upper field if necessary. Turn the controller until "Languages" is selected and press the controller.



6. Select "Navigation voice instructions" and press the controller.

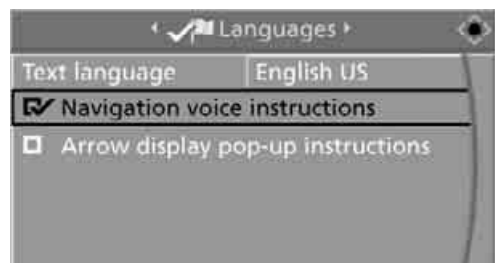

1.  The voice instructions are switched on.

The setting is stored for the remote control currently in use*.

Repeating and canceling voice instructions

With the programmable buttons on the steering wheel you can also create the following settings, refer to page 56:

- ▷ Repeat the voice instruction:
Press button.
- ▷ Switch voice instructions on/off:
Press button longer.

Setting volume of voice instructions

The volume can only be adjusted while a voice instruction is being output.

1. Repeat the last voice instruction, if necessary.
2. Turn the knob during the voice instruction to select the desired volume.



This volume is independent of the volume of the audio sources.

The setting is stored for the remote control currently in use.

Bypassing route sections

During destination guidance, you can revise the navigation system's route recommendations to avoid particular stretches of road. Enter the number of miles/kilometers that you want to travel before returning to the original route.

1. Select "Navigation" and press the controller.
2. Change into the third field from the top. Turn the controller until "New route" is selected and press the controller.

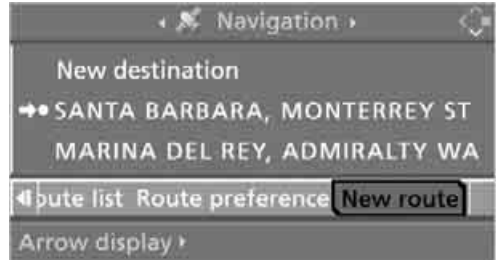

3. Turn the controller to enter the desired number and press the controller.

The route is recalculated.

To exit from the menu without changing the route:

- ← Select the arrow and press the controller.

Traffic information*

In many congested areas, you can receive traffic information transmitted by radio stations.

The traffic conditions are monitored by traffic management centers and the traffic information is periodically updated.

During destination guidance, the traffic information relevant to your planned route is automatically displayed. Whether destination guidance is active or not, you can have the traffic information displayed in the map view or in the traffic info list.

Switching reception of traffic information on/off

iDrive, for operating principle refer to page 16.

1. Press the **MENU** button.
This opens the start menu.
2. Press the controller to open the **i** menu.

- Turn the controller until "Settings" is selected and press the controller.



- Turn the controller until "Traffic Info settings" is selected and press the controller.

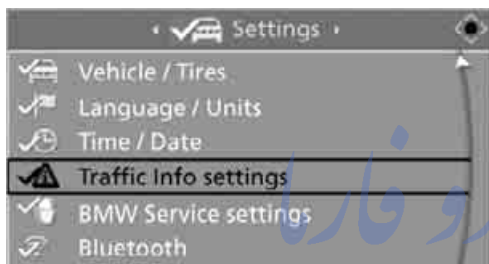

- Select "Traffic Info" and press the controller.

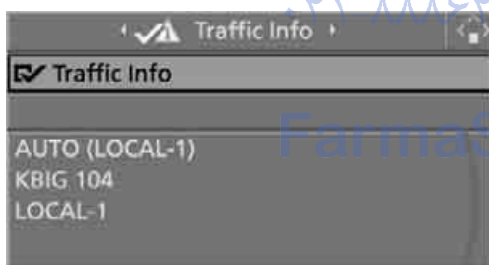

The traffic information can be received and displayed.

"AUTO": automatic selection of the Traffic Info station with the best reception.

Depending on the station, either the station name, frequency, local number or other information is displayed. ◀

Manually displaying traffic information

During destination guidance

During destination guidance, traffic information can be displayed in the arrow or map view.

If the  symbol is shown with a red border, traffic information is available for the planned route.

 Select the symbol and press the controller.



During destination guidance, the traffic information on the planned route is marked with a yellow diamond.

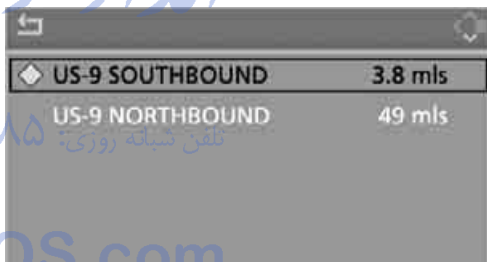

First the traffic information along the planned route is shown sorted according to the distance to the current vehicle position.

With destination guidance switched off

- Open the start menu.
- Move the controller to the right to open "Navigation".

3. Select "Traffic Info" and press the controller.

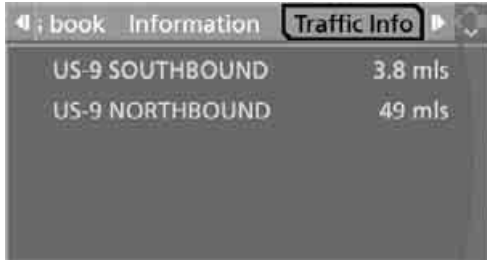

First the traffic information along the planned route is shown sorted according to the distance to the current vehicle position.

Depiction of traffic information in map view

The traffic information symbols are shown in the map view up to a scale of 100 miles/200 km.

The section of the route affected by a traffic report as well as the number for the type of incident are displayed and hidden. This occurs as a function of the scale selected.

Displaying detailed traffic information

Select a traffic information item from the list and press the controller.

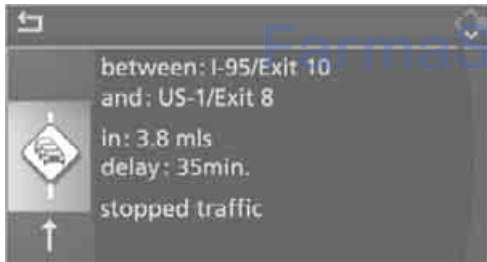



To exit from the menu:





Select the arrow and press the controller.

Symbols for traffic information

- Traffic event with map scales greater than 5 miles/10 km, arrow points in the direction of travel concerned.
- Several traffic events have been received. Select a smaller scale to display these individually.
- Traffic light failure
- Roadwork
- General traffic obstruction
- Transport of hazardous load
- Vehicle on wrong carriage way
- Danger
- Low clearance
- No parking
- Fog
- Heavy rain
- Slippery road
- Cross winds
- Smog
- Road close
- Slow traffic
- Traffic back up
- Stopped traffic
- Icy roads
- Uneven surface
- Accident

-  Lane closure
-  Delay
-  Police checkpoint



-  Slow traffic or other event
-  Stop-and-go traffic
-  Stopped traffic
-  Traffic event in both directions of travel

Traffic information during destination guidance

System response will vary depending on whether or not "Dynamic route" is selected, refer to page 154.

Displaying traffic obstructions

If a traffic obstruction is reported to the navigation system and "Dynamic route" is not selected, you will be provided with specific information beginning at a distance of approx. 25 miles/40 km, e.g. the length of the congestion.

The last possible junction will be displayed shortly before this.



Select "Detour" and press the controller. The navigation system determines a new route to avoid the traffic jam.

This information is also displayed if you have called up a different application on the Control Display.

Dynamic route planning

When "Dynamic route" is selected, the route will be changed automatically in the event of a traffic obstruction. The system does not point out traffic obstructions along the original route. Depending on road type as well as the nature and extent of the traffic obstruction, the calculated route may also lead through the traffic obstruction.

Displaying current position

You can have your current position displayed even when the destination guidance is switched off.

1. Select "Navigation" and press the controller.
2. Change into the fourth field from the top. Turn the controller until "Current position" is selected and press the controller.

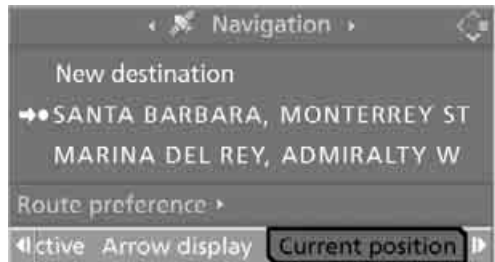

The current position of your BMW is displayed.

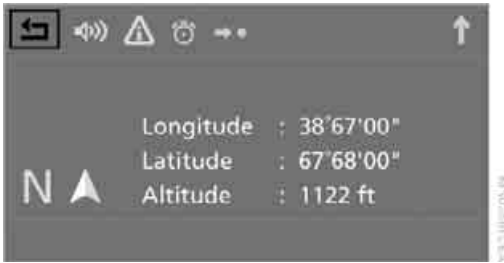

If the navigation system is unable to identify a town/city, your current map coordinates will appear.

To exit the menu:

↩ Select the arrow and press the controller.

You can also have the current position displayed on a map, refer to page [158](#).

امداد خودرو فارما

تلفن شبانه روزی: ۰۲۱-۸۸۸۶۲۰۸۵

FarmaSOS.com

What to do if ...

What to do if ...

- ▶ a navigation DVD is inserted, but an instruction to insert the DVD appears on the Control Display?

The navigation DVD may not be the correct DVD for the navigation system. This information is indicated on the DVD label.

- ▶ you request the current position of your vehicle, but do not receive a precise display?

The system is unable to receive enough GPS signals at your current position due to obstructions, your position is not yet available on your navigation DVD, or the system is in the process of calculating your position. Reception is best when you have an unobstructed view to the sky.

- ▶ the destination guidance does not accept a destination?

The data of the destination is not stored on the navigation DVD that is loaded. Select a destination that is as close as possible to the original.

- ▶ the destination guidance does not accept an address without the street name?

On the navigation DVD, no downtown area can be determined for the city or town entered. Enter any street, or a destination such as the railway station in the selected town, and then start the destination guidance.

- ▶ you want to enter a destination for the destination guidance, but it is not possible to select the letters for your desired entry?

The data of the destination is not stored on the navigation DVD that is loaded. In this case, the system will not offer you any letters to choose from. Select a destination that is as close as possible to the original.

- ▶ the system stops furnishing directions on which way to turn as you approach intersections?

You are driving in an area that has not yet been completely recorded on the naviga-

tion DVD. Instead of an arrow indicating a turn, you will see an arrow which indicates the general direction of your planned route. Or you have left the recommended route and the system requires a few seconds to calculate a new recommended route.

- ▶ the navigation system does not react to entries?

If the battery was disconnected, it takes about 10 minutes before the system is once again operational.



امداد خودرو فارما

تلفن شبانه روزی: ۰۲۱-۸۸۸۶۲۰۸۵

FarmaSOS.com

Entertainment

Operation of the radio, CD equipment and external audio devices as well as their tone settings are described in this chapter.

امداد خودرو فارما

تلفن شبانه روزی: ۰۲۱-۸۸۸۶۲۰۸۵

FarmaSOS.com

On/off and tone

The following audio sources have shared controls and setting options:

- ▷ Professional* radio or Business radio
- ▷ CD player
- ▷ CD changer*

Controls

The audio sources can be operated using:

- ▷ Buttons in the area of the CD player
- ▷ iDrive
- ▷ Buttons on steering wheel, refer to page 11
- ▷ Programmable memory buttons, refer to page 22

Buttons in area of CD player

The layout of the buttons can vary depending on your vehicle's equipment.

One drive:



Two drives:



- 1 Entertainment sound output on/off, volume
 - ▷ Press: switch on/off.
When the system is switched on, the most recently selected radio station or CD track is played.
 - ▷ Turn: adjust volume.
- 2 Drive for audio CDs
- 3 Eject CD
- 4 Station scan/track search
 - ▷ Change radio station.
 - ▷ Select track for CD player and CD changer.
- 5 Drive for navigation DVDs

Operation via iDrive

iDrive, for operating principle refer to page 16.

1. Press the **MENU** button.
This opens the start menu.
2. Move the controller backwards to open "Entertainment".



You have the following choices:

- ▷ "FM" and "AM": radio reception
- ▷ "WB": weatherband station
- ▷ "SAT": satellite radio
- ▷ "CD": CD player or CD changer*
- ▷ "AUX" AUX-IN connection
- ▷ USB-audio interface*
- ▷ "Set": depending on the audio source, other adjustments can be made, e.g. with the radio: update station with strongest

reception, store station, tone control, sample stations.

 From another menu, you can change directly to the screen last displayed, refer to Comfort opening of menu items, page 19. ◀

From radio readiness, the selected audio source is stored for the remote control currently in use.

Switching on/off

To switch the Entertainment sound output on and off:

Press knob **1** next to the CD player.

 This symbol on the Control Display indicates that sound output is switched off.

For a single drive, the sound output is available for approx. 20 minutes with the ignition switched off.

Switch on the sound output again for this purpose.

Adjusting volume

Turn knob **1** next to the CD player until the desired volume is set.

You can also adjust the volume with the buttons on the steering wheel, refer to page 11.

From radio readiness, the setting is stored for the remote control currently in use.

Tone control

You can alter various tone settings, e.g. treble and bass, or the speed-dependent volume increase.

The tone settings are set for all audio sources at once.

From radio readiness, the settings are stored for the remote control currently in use.

Changing tone settings

1. Press the **MENU** button.
This opens the start menu.
2. Press the controller to open the **i** menu.
3. Turn the controller until "Settings" is selected and press the controller.



4. "Audio" and press the controller.

The tone settings can also be selected if you have called up "Entertainment" in the start menu:

Select "Set" and then "Tone", pressing the controller after each selection.

Treble and bass

1. Change to upper field if necessary. Turn the controller until "Treble / Bass" is selected and press the controller.



2. Move the controller to the left or right to select "Treble" or "Bass".



3. Turn the controller until the desired setting is selected.

Balance and fader

You can adjust the volume distribution in the same manner as "Treble / Bass".

- ▷ "Balance": left/right volume distribution
- ▷ "Fader": front/rear volume distribution

Speed-dependent volume control

The speed-dependent volume control increases the volume with increasing speed. You can set various stages for the increase in volume.

1. Select "Speed volume" and press the controller.



2. Turn the controller: The adjustment is applied; the field can be changed.



Individual high-end sound system*

You can choose between Stereo and Surround.

1. Select "Surround Settings" and press the controller.

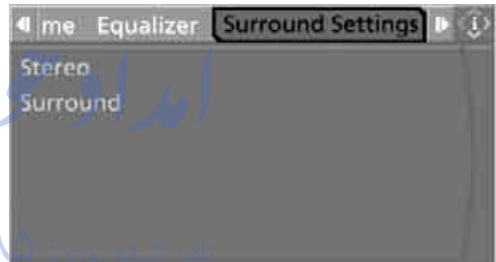

2. Select "Stereo" or "Surround".

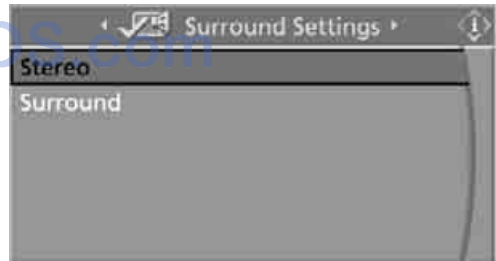

3. Press the controller. The spatial sound effect is activated.

Professional LOGIC7 HiFi System*

You can select a spatial sound effect that improves the spatial acoustics in all frequency ranges.

1. Select "Surround Settings" and press the controller.



2. Select "Concert hall" or "Theater".

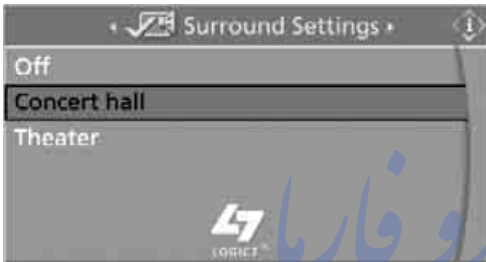

3. Press the controller. LOGIC7 spatial sound is switched on.

To cancel the spatial sound effect:
Select "Off" and press the controller.

LOGIC7 and the LOGIC7 logo are registered trade marks of Lexicon, Inc., a company of the Harman International Group.

Equalizer*

You can set individual sound frequency ranges.

1. Select "Equalizer" and press the controller.



2. Move the controller to the left or right to select the desired frequency range.

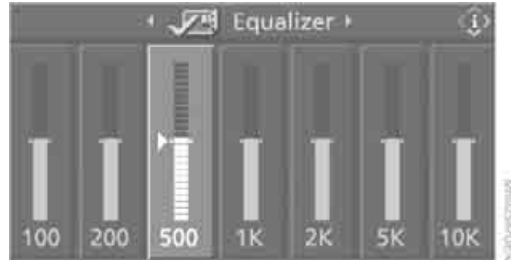

3. Turn the controller until the desired setting is selected.

Resetting tone settings

You can reset all tone settings to the default settings.

1. Open the start menu.
2. Press the controller to open the **i** menu.
3. Turn the controller until "Settings" is selected and press the controller.
4. Select "Audio" and press the controller.
5. Change to upper field if necessary. Turn the controller until "Reset" is selected and press the controller.



With two drives: Select "Yes".

FarmaSOS.com

Radio

Your radio provides reception of the FM and AM wavebands.

Listening to radio



Press the knob if the sound output is switched off.

iDrive, for operating principle refer to page 16.

1. Press the **MENU** button.
This opens the start menu.
2. Move the controller backwards to open "Entertainment".
3. Change to upper field if necessary. Turn the controller until "FM" or "AM" is selected.

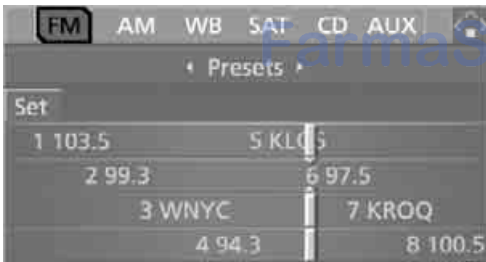

4. Press the controller.

Stations are shown on the Control Display on the basis of various selection criteria, e.g. "Presets".

If "Autostore" does not display any stations or if the stations displayed can no longer be received, update the stations with the strongest signal, refer to page 174.

Changing stations



Turn the controller.

In addition to the stations currently displayed, you can have stations with another selection criterion displayed.

Professional radio*

You can choose from the following selection criteria:

- ▷ "All stations":
Stations that can currently be received in the "FM" waveband.
- ▷ "Autostore": تلف
Stations with the best reception on the "AM" waveband.
- ▷ "Presets":
Stations you have previously stored, refer to page 174.
- ▷ "Manual":
To set stations that can be received in addition to those displayed, refer to Selecting frequency manually on page 173.

Business radio

You can choose from the following selection criteria:

- ▷ "Autostore"
Stations with the strongest signal, refer to page 174.
- ▷ "Presets":
Stations you have previously stored, refer to page 174.

- ▷ "Manual":
To set stations that can be received in addition to those displayed, refer to Selecting frequency manually on page 173.

Changing selection criteria

In addition to the stations currently displayed, you can have stations with another selection criterion displayed.

You can choose from the following selection criteria:

- ▷ "All stations":
Stations that can currently be received in the "FM" waveband.
- ▷ "Autostore":
Stations with the best reception on the "AM" waveband.
- ▷ "Presets":
Stations you have previously stored, refer to page 174.
- ▷ "Manual":
To set stations that can be received in addition to those displayed, refer to Selecting frequency manually on page 173.

1. Change into the second field from the top.
2. Turn the controller until the desired selection criterion is selected and press the controller.



Buttons next to CD player

Press the  button for the corresponding direction.
The system changes to the next displayed station.
You can also change stations with the buttons on the steering wheel, refer to page 11.

Sampling stations, scan

The system plays a brief sample from each of the stations on the current waveband.

1. Select "FM" or "AM" and press the controller.
"Set" is selected.
2. Press the controller.
Other menu items are displayed.
3. Select "Scan" and press the controller.



The stations are sampled.

To end sampling:

1. Press the controller.
2. Select "Scan" and press the controller.

This cancels sampling of the stations, and the radio remains on the current station.

Buttons next to CD player

To sample the stations, press and hold the  button for the corresponding direction.
To stop scanning, press the button again.

Selecting frequency manually

With "Manual" you can select stations that are received in addition to those displayed.

1. Select "FM" or "AM" and press the controller.
2. Change into the second field from the top.

3. Select "Manual" and press the controller.



4. Turn the controller to set a certain frequency.

Updating stations with best reception

Radio Professional on "AM" and Radio Business:

If you are on a longer journey and leave the transmission range of the stations originally set, you can update the list of stations with the best reception.

1. Select "FM" or "AM" and press the controller.
2. Change into the second field from the top.
3. Select "Autostore" and press the controller. "Set" is selected.



4. Press the controller. Other menu items are displayed.

5. Select "Autostore" and press the controller.



The display of the stations with the best reception is updated. The frequencies of the stations are displayed.

Storing stations

Via iDrive

1. Select "FM" or "AM" and press the controller.
2. Change into the second field from the top. Turn the controller until the desired selection criterion is selected and press the controller.
3. Select the desired frequency or station. "Set" is selected.



4. Press the controller. Other menu items are displayed.

5. Select "Store" and press the controller.

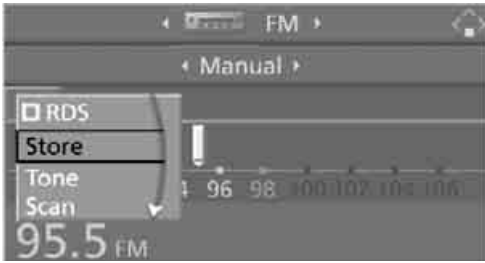

"Presets" is displayed.

- Turn the controller until the desired memory position is selected.
- Press the controller. The station is stored.

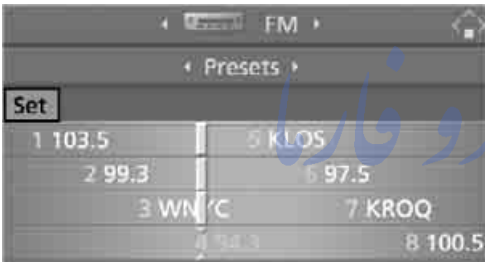

The stations of the last selection criterion are displayed once again after a short time.

From radio readiness, the stations are stored for the remote control currently in use.

About programmable memory buttons

You can also store a station on the programmable memory buttons, also refer to page 22.

- Select a station.
- Press and hold desired button

Changing a memory position

- Select "Presets" and press the controller.
- Select the desired station. "Set" is selected.
- Press the controller. Other menu items are displayed.

4. Select "Store" and press the controller.



- Turn the controller until the desired memory position is selected. The number of the memory position appears beside the name or frequency of the station.
- Press the controller. The station is stored.

RDS Radio Data System

In the FM frequency range, additional information is transmitted via RDS. If the reception conditions are good, the station names are shown on the Control Display. If the reception is weak or disrupted, it can take some time before the station names are displayed.

Switching RDS on/off*

- Select "FM" and press the controller. "Set" is selected.
- Press the controller. Other menu items are displayed.
- Select "RDS" and press the controller.



RDS is activated.

The setting is stored for the remote control currently in use.

Weather news flashes*

Weather Radio is a service of the National Oceanic and Atmospheric Administration (NOAA) of the US Department of Trade. Weather news flashes are repeated every 4 to 6 minutes and are routinely updated at intervals of 1 to 3 hours, and more often when necessary. Most stations operate 24 hours a day. In case of a storm, the National Weather Service interrupts the routine weather news and transmits special warning messages instead. If you have a question about NOAA Weather Radio, please contact the nearest office of the National Weather Service. Details are also provided on the Internet at www.nws.noaa.gov.

Calling up weather news flashes

1. Select "WB" and press the controller.



2. Select a station.

The station for weather news flashes may be unavailable in some regions.

High Definition Radio*

Many stations transmit both analog and digital signals. You can receive these stations digitally and with improved sound quality.

A digital radio network must be available in order to receive digital stations.

HD Radio™ technology manufactured under license from iBiquity Digital Corp. U.S. and Foreign Patents. HD Radio™ and the HD and HD Radio logos are proprietary trademarks of iBiquity Digital Corp.

Activating/deactivating digital radio reception

iDrive, for operating principle refer to page 16.

1. Press the **MENU** button.
This opens the start menu.
2. Press the controller to open the **i** menu.
3. Turn the controller until "Settings" is selected and press the controller.
4. Select "Audio" and press the controller.
5. Change to upper field. Turn the controller until "HD radio" is selected and press the controller.



6. Select "Off" and press the controller.

The reception of digital stations is activated.
 This symbol is displayed when a station is being received digitally.



With some stations the digital signals are not transmitted simultaneously with the analog signals. If you are in an area in which the selected station is not continuously received digitally, playback changes between analog and digital reception. This can result in repetitions or interruptions. In this case it may be advisable to deactivate digital radio reception.

Selecting programs of a digital station*

Some stations transmit several programs. To select one of these programs:

1. Select "FM" or "AM" and press the controller.

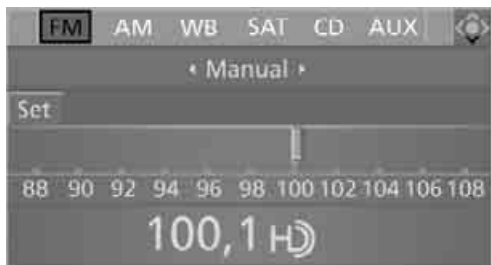

2. Select "Manual" and press the controller.
3. Select a station that is received digitally. HD This symbol is displayed when a station is being received digitally.
4. Switch to the next program of the digital station with the < > buttons on the radio or the steering wheel.

You can store a station, refer to page 174.

Updating stations offering digital reception

If you are on a longer journey and leave the transmission range of the stations originally set, you can update the list of stations with the best reception.

1. Select "FM" or "AM" and press the controller.



2. Change into the second field from the top.

3. Select "Autostore" and press the controller.



4. Press the controller. Other menu items are displayed.
5. Select "Autostore HD" and press the controller.

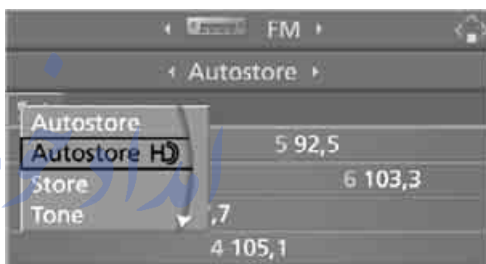

The display of the stations offering digital reception is updated. This can take up to 2 minutes.

Displaying additional information

With the digital stations, additional information on the current track is displayed, e.g. the name of the artist.

1. Select a station and press the controller.
2. Select "Details" and press the controller.



✓ The information is displayed.



If a digital station is received again when the station is changed, the additional information will be displayed again following a brief interruption.

امداد خودرو فارما

تلفن شبانه روزی: ۰۲۱-۸۸۸۶۲۰۸۵

FarmaSOS.com

Satellite radio*

You can receive over 100 different channels with high sound quality.

The channels are offered to you in predefined packages. To receive the channels of your choice, you must have this package enabled.

 With this new technology the signal may fail, causing interruptions in reception. ◀

Enabling or disabling channels

iDrive, for operating principle refer to page 16.

1. Press the **MENU** button.
This opens the start menu.
2. Move the controller backwards to open "Entertainment".
3. Select "SAT".



4. Press the controller.

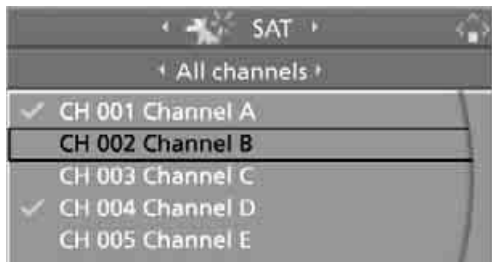

The channels are displayed.

✓ These channels are enabled.

Enabling

1. Select a channel that has not yet been enabled and press the controller.
A telephone number and the electronic serial number, ESN, are displayed.

 The electronic serial number is required for enabling or disabling. ◀

2. To enable the channels:
Dial the phone number.

Disabling

1. Select an enabled channel and press the controller.

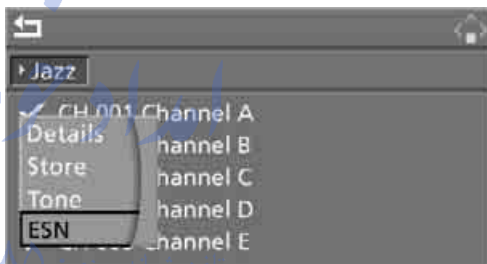

2. Select "ESN" and press the controller.
The electronic serial number, ESN, is displayed.

 The electronic serial number is required for disabling. ◀

3. To disable the channels:
Dial the phone number.

Selecting and storing channel

1. Select "SAT" and press the controller.



Channels or categories appear in the Control Display.

2. Select a menu item:

- ▷ "Presets":
Up to twelve channels you have stored previously.
- ▷ "All channels":
All channels are displayed.
- ▷ "Categories":
All channels, sorted by category, e.g. news, jazz.



3. Press the controller.

4. If "Categories" has been selected:

Select the desired category and press the controller.

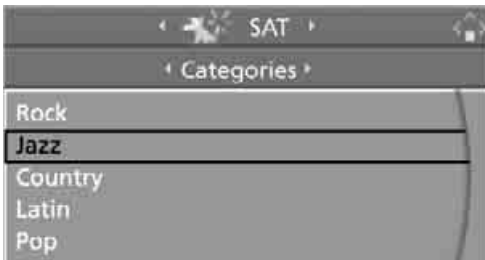

The channels of this category are displayed.

5. ✓ Select a channel marked with this symbol.

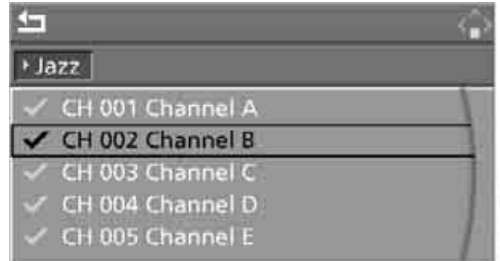

6. Press the controller.

Other menu items are displayed.

7. Select "Details" and press the controller.

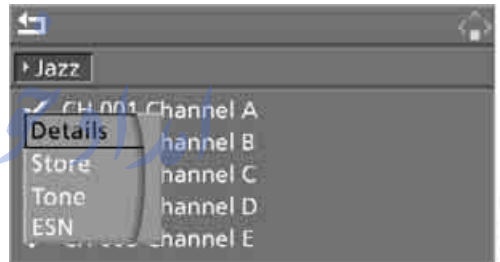

Additional information

The name of the channel and additional information on the current track are displayed, e.g. the name of the artist.

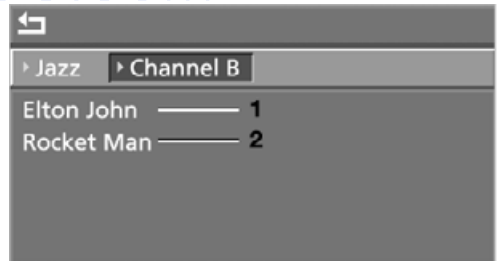

1 Artist

2 Track

Storing channel

1. Select desired channel.

2. Press the controller.

Other menu items are displayed.

3. Select "Store" and press the controller.

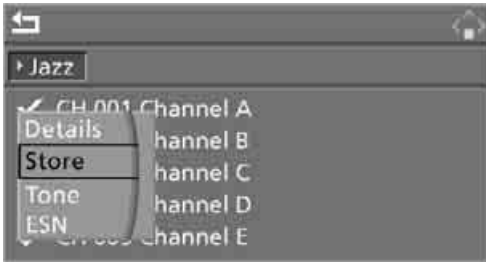

"Presets" is displayed.

4. Turn the controller to select a memory location and press the controller.



The channel is stored. The channels of the last selection criterion are displayed once again after a short time.

تلفن شبانه روزی: ۰۲۱-۸۸۶۲۰۸۵

Changing channel with buttons next to CD player

Press the  button for the corresponding direction.

The system changes to the next enabled channel.

Notes

If no signal can be received for more than 4 seconds, a message is displayed on the Control Display.



Reception may not be possible for certain reasons, e.g. environmental influences or topographical conditions. The satellite radio has no influence on this.

The signal may not be available in tunnels or underground garages, next to tall buildings, near trees, mountains or other sources of radio interference.

Reception is usually possible again as soon as the signal is available again. ◀

CD player and CD changer*

Listening to CDs

Compressed audio files*

CDs with compressed audio files, i.e. MP3, can be played by the CD player, but not by the CD changer.

CD player: starting CD



With two drives:
The upper drive is for audio CDs.

Inserting CD

Insert the CD into the drive with the labeled side up. The CD is retracted.

Playback starts automatically if the sound output is on. For CDs with compressed audio files, it can take up to approx. 1 minute to read in the data depending on the directory structure.

Via iDrive

To start playback when there is already a CD in the drive:

iDrive, for operating principle refer to page 16.

1. Press the **MENU** button.
This opens the start menu.
2. Move the controller backwards to open "Entertainment".

3. Change to upper field if necessary. Turn the controller until "CD" is selected and press the controller.



4. With a CD changer, change to the second field from the top and turn the controller until "CD" is selected and press the controller.
The CD player is started.



Playback starts automatically if the sound output is switched on.

About programmable memory buttons

You can store the CD player function on the programmable memory buttons. To start the CD player, refer to page 22.

Eject CD

Press the  button next to CD player.
The CD emerges slightly from the drive.

CD changer: starting CD

Fill the CD magazine and insert, refer to page 186.

Via iDrive

1. Press the **MENU** button.
This opens the start menu.
2. Move the controller backwards to open "Entertainment".
3. Change to upper field if necessary. Turn the controller until "CD" is selected and press the controller.
4. Change to the second field from the top if necessary. Turn the controller until the desired CD, CD 1 - 6, is selected and press the controller.



At the end of the last track, the next CD will be selected.

If the CD magazine has been newly filled, playback begins with the lowest CD, e.g. CD 1, track 1.

The CD magazine's load status is indicated on the Control Display.

About programmable memory buttons

You can store a CD compartment of the CD changer on the programmable memory buttons. To start the CD changer, refer to page 22.

Selecting a track

Buttons next to CD player

Press the  button for the corresponding direction repeatedly until you reach the desired track.

The CD will start play at the start of the track. The track is displayed on the Control Display.

You can also change the track with buttons on the steering wheel, refer to page 11.

Via iDrive

Select a track by turning the controller.

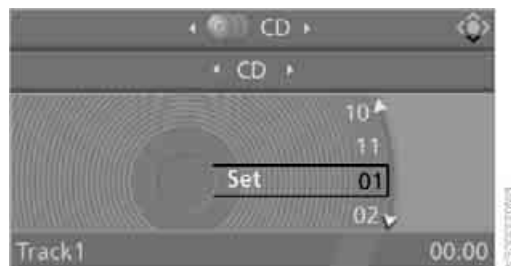

Compressed audio files*

1. Select the directory if necessary and press the controller.



2. Select the track and press the controller.

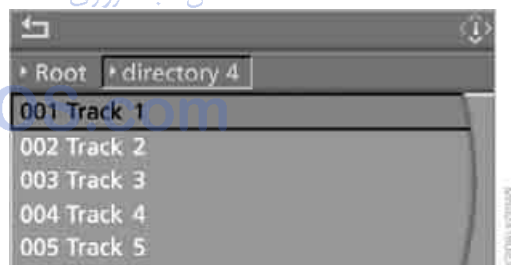

To change the directory:

Select the directory and press the controller.

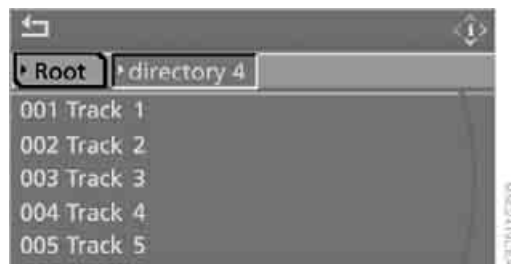

To exit from the menu:

← Select the arrow and press the controller.

You can also store a particular track on the programmable memory buttons, refer to page 22.

Displaying information on track*

With compressed audio files, you can display any information stored on the current track, e.g. the name of the artist.

1. Press the controller.
2. Select "Details" and press the controller.

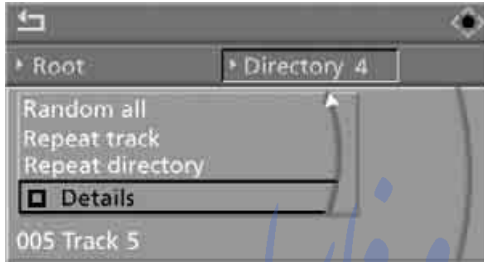

The information for the current track are displayed.

From radio readiness, the setting is stored for the remote control currently in use.

Sampling tracks, scan

The system plays a brief sample from each of the tracks on the current CD.

1. Select "Set" and press the controller. Other menu items are displayed.



2. Select "Scan" and press the controller.



To end sampling:

1. Press the controller.
2. Select "Scan" and press the controller.

This cancels sampling of the tracks, and the player remains on the current track.

Compressed audio files*

1. Select the current track and press the controller.
2. Select the desired menu item:
 - ▷ To sample all tracks of the current directory, select "Scan directory" and press the controller.
 - ▷ To sample all tracks of the CD, select "Scan all" and press the controller.

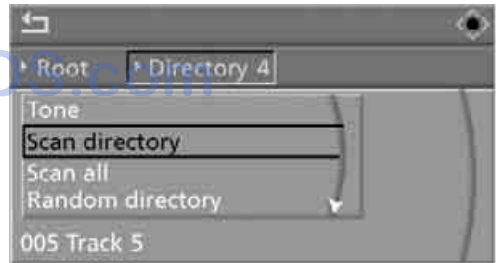

To end sampling:

1. Press the controller.
2. Select "Scan directory" or "Scan all" and press the controller.

This cancels sampling, and the player remains on the current track.

Repeating a track

1. Select "Set" and press the controller. Other menu items are displayed.



2. Select "Repeat" and press the controller.

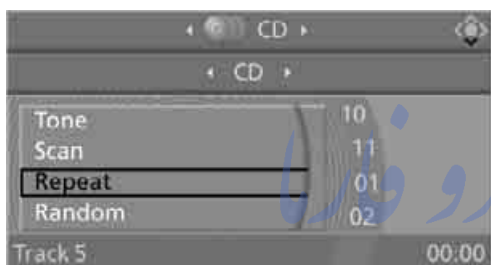

The current track on the CD is repeated.

To stop repeating:

1. Press the controller again.
2. Select "Repeat" and press the controller.

Compressed audio files*

1. Select the current track and press the controller.
2. Select the desired menu item:
 - ▷ To repeat the selected track, select "Repeat track" and press the controller.
 - ▷ To repeat all tracks of the current directory, select "Repeat directory" and press the controller.



To stop repeating:

1. Press the controller.
2. Select "Repeat track" or "Repeat directory" and press the controller.

Random play sequence

In this mode, the tracks on the current CD are played once in a random sequence.

1. Select "Set" and press the controller. Other menu items are displayed.
2. Select "Random" and press the controller.

To stop random function:

1. Press the controller.
2. Select "Random" and press the controller.

Compressed audio files*

1. Select the current track and press the controller.
2. Select the desired menu item:
 - ▷ To play all tracks of the current directory in random order, select "Random directory" and press the controller.
 - ▷ To play all tracks of the CD in random order, select "Random all" and press the controller.

To stop random function:

1. Press the controller.
2. Select "Random directory" or "Random all" and press the controller.

Fast forward/reverse

Buttons next to CD player:

Press and hold the  button for the corresponding direction.

CD magazine

The BMW CD changer for six CDs is installed in the glove compartment.

Removing CD magazine

To insert CDs into the CD magazine 1 or remove them from it, you must first remove the magazine from the CD changer:

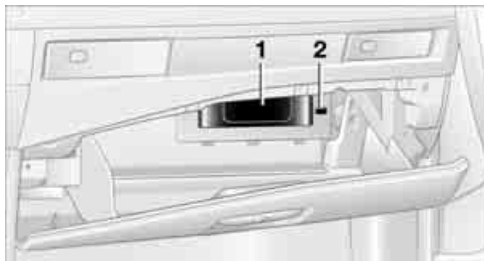

Press button 2: the CD magazine 1 slides out. Wait at least 2 seconds before pushing in the magazine again so that the inserted CDs can be read in again.

Inserting/removing CDs into/from CD magazine

When inserting or removing CDs, remember to hold them by their edges, taking care to avoid touching the data side with its reflective CD memory surface.

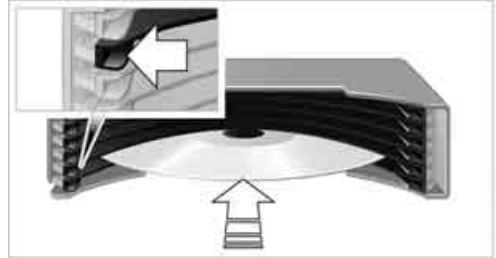

Inserting CDs:

Insert one CD into each compartment of the magazine with the labeled side up.



Removing CDs:

Pull out the desired tray and remove the CD.

Inserting CD magazine

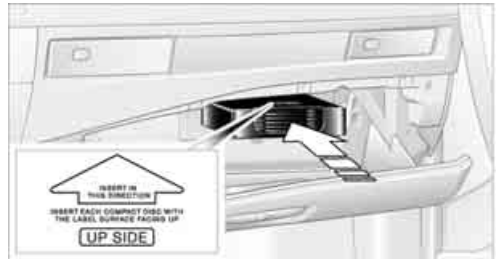

Push in the CD magazine as far as possible in the direction of the arrow.

The CD changer reads in the loaded CDs and is then ready for operation.

Notes

 BMW CD/DVD players and changers are officially designated Class 1 laser products. Do not operate if the cover is damaged, otherwise severe eye damage can result. Do not use self-recorded CDs/DVDs with labels applied as these can become detached during playback due to heat buildup and can cause irreparable damage to the device.

Only use round CDs/DVDs with a standard diameter of 4.7 in/12 cm and do not play CDs/DVDs with an adapter, e.g. CD singles, as otherwise the CD/DVD or the adapter can jam and may no longer eject properly.

Do not use a combined CD/DVD, e.g. DVD^{Plus}, otherwise the CD/DVD can jam and will no longer eject. ◀

General malfunctions

BMW CD/DVD changers and players have been optimized for performance in vehicles. In some instances they may be more sensitive to faulty CDs/DVDs than stationary devices would be.

If a CD/DVD cannot be played, first check whether it has been inserted correctly.

Humidity

High levels of humidity can lead to condensation on the CD/DVD or the laser's scan lens and temporarily prevent playback.

Malfunctions with individual CDs/DVDs

If malfunctions occur only with particular CDs/DVDs, this can be due to one of the following causes.

Self-recorded CDs/DVDs

Possible reasons for malfunctions with self-recorded CDs/DVDs are, e.g. inconsistent data-creation or recording processes, or poor quality or high age of the CD/DVD blank.

Only label CDs/DVDs on the upper side with a pen intended for this purpose.

Damaged CDs/DVDs

Avoid fingerprints, dust, scratches and moisture.

Store CDs/DVDs in a sleeve.

Do not subject CDs/DVDs to temperatures over 122 °F /50 °C, high levels of humidity or direct sunlight.

CDs/DVDs with copy protection

CDs/DVDs are often provided with a copy protection feature by the manufacturer. This can mean that some CDs/DVDs cannot be played or can only be played to a limited extent.

Care

If necessary, clean the reflective scanning side of the CDs/DVDs with a commercially available cleaning cloth by wiping in straight lines from the center outward.

امداد خود را

تلفن شبانه روزی: ۰۲۱-۸۸۶۲۰۸۵

ArmaSOS.com

AUX-IN connection

You can connect an external audio device, e.g. an MP3 player, and play the sound via the vehicle speakers. The sound can be adjusted via iDrive.

Connecting

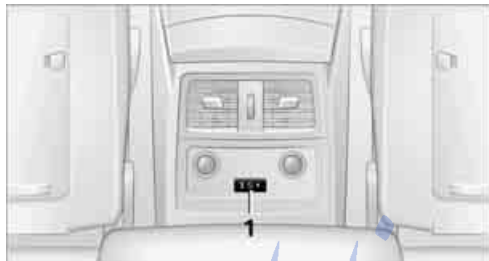

- 1** Connection for audio playback:
1/8 in/3.5 mm jack plug

To play audio tracks through the vehicle's speaker system, connect the headset or line-out port of the external device to connection **1**.

- 3.** Change to upper field if necessary. Turn the controller until "AUX" is selected and press the controller.



- 4.** Select "AUX IN" and press the controller.
5. Adjust volume and sound if necessary.

About programmable memory buttons

You can save the audio AUX function on the programmable memory buttons. To start audio playback, refer to page 22.

Starting audio playback

The audio device must be switched on.

Via iDrive

iDrive, for operating principle refer to page 16.

- Press the **MENU** button.
This opens the start menu.
- Move the controller backwards to open "Entertainment".

USB-audio interface/mobile phone audio interface*

You can connect audio devices, e.g. an iPod/iPhone or a USB device (MP3 player, USB flash drive), to the USB-audio interface. You can then operate these via iDrive.

When using an iPhone/mobile phone as a music player, connect the device to the snap-in adapter, refer to the separate operating instructions. Playback is only possible if a device is not connected to the USB-audio interface.

The system can play back common audio files, e.g. MP3, WMA, WAV (PCM) and AAC, as well as playback lists in the M3U format.

Due to the large number of audio devices available on the market, operation via the vehicle cannot be ensured for every audio device.

Ask your BMW center which audio devices are suitable.

Connecting

Lift up the center armrest.



- 1 USB-audio interface
- 2 Connection for audio playback:
1/8 in/3.5 mm jack plug

iPod/iPhone

To connect the iPod/iPhone, use the BMW cable adapter for the Apple iPod/iPhone. For more information, please contact a BMW center or consult our website: www.bmw.com

To play audio tracks over the vehicle's loud-speaker system, connect the iPod/iPhone to ports **1** and **2**.

The iPod/iPhone menu structure is supported by the USB-audio interface.

USB device

 To connect the device, use a flexible adapter cable to protect the USB-audio interface and your USB device against physical damage. ◀

For audio playback via the vehicle speakers, connect the USB device to the connection **1**.

After connecting for the first time, the information of all tracks (e.g. artist, music genre) and the playback lists of the USB device are transferred to the vehicle. This process can take some time. The time required is dependent on the USB device and on the number of tracks.

During the transfer you can select the tracks via the directories and file names.

Following the transfer you can call up the tracks via the information and playback lists.

Information from up to four USB devices can be stored in the vehicle, or a total of approx. 16,000 tracks.

If a fifth USB device is connected, the information of the tracks of the first USB device stored in the vehicle is deleted.

 Music tracks with integrated Digital Rights Management (DRM) cannot be played. ◀

Starting audio playback

Via iDrive

If the audio device has a device name, this will be displayed if possible.

1. Press the **MENU** button. This opens the start menu.
2. Move the controller backwards to call up "Entertainment".
3. Change to upper field if necessary. Turn the controller until "AUX" is selected and press the controller.



4. Select "USB" or the name of the audio device and press the controller.



5. The playback starts with the first track.

About programmable memory buttons

You can store the "USB" function on the programmable memory keys to start audio playback, refer to page 22.

Selecting a track

You can call up the tracks via the playback lists and information. With USB devices you can also call up the tracks via the file directory.

1. Make your selection, e.g. "Playlists" or "Artists", and press the controller.



2. Select the track and press the controller.

Displaying information on track

You can display any information stored on the current track, e.g. the name of the artist.

1. Press the controller during playback.
2. Select "Details" and press the controller.

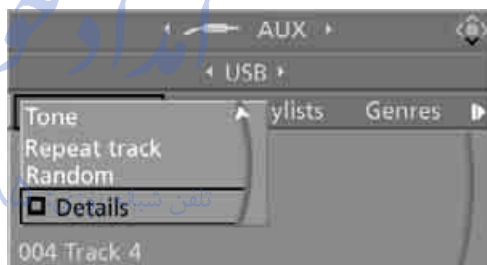

The information for the current track are displayed.

Repeating a track

1. Select the current track and press the controller.
2. Select "Repeat track" and press the controller.

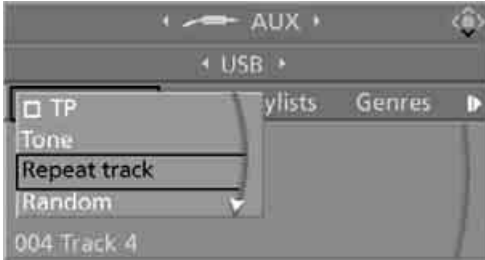

To stop repeating:

1. Press the controller.
2. Select "Repeat track" and press the controller.

Random play sequence

You can play back the tracks of the selected list in random order, e.g. all tracks of an artist.

1. Select the current track and press the controller.
2. Select "Random" and press the controller.

End random playback:

1. Press the controller.
2. Select "Random" and press the controller.

Fast forward/reverse

Buttons next to CD player:

Press and hold the  button for the corresponding direction.

Notes

 Do not subject the audio device to extreme environmental conditions, e.g. extremely high temperatures, refer to the operating instructions of the audio device. Other-

wise, the audio device can be damaged and the resulting distraction can reduce road safety while driving. ◀

Depending on the configuration of the audio files, e.g. bit rates greater than 256 Kbit/s, proper playback cannot always be ensured.

Connecting instructions

- ▶ The USB/audio interface supplies the connected audio device with power, provided the audio device supports this function. It is therefore unnecessary to connect the audio device to a socket in the vehicle during operation.
- ▶ Do not use force when plugging the connector into the USB-audio interface.
- ▶ Do not connect devices such as fans or lamps to the USB-audio interface.
- ▶ Do not connect USB hard disks.
- ▶ Do not use the audio interface to recharge external devices.



امداد خودرو فارما

تلفن شبانه روزی: ۰۲۱-۸۸۸۶۲۰۸۵

FarmaSOS.com

Communications

This chapter summarizes how to operate your mobile phone using iDrive or voice control and how to use BMW Assist or BMW TeleServices.

امداد خودرو فارما

تلفن شبانه روزی: ۰۲۱-۸۸۸۶۲۰۸۵

FarmaSOS.com

Telephoning*

The concept

Your BMW is equipped with a full mobile phone preparation package. After pairing a suitable mobile phone in the vehicle once, you can operate the mobile phone via iDrive, with the buttons on the steering wheel and by voice.

A mobile phone that has been paired once is automatically detected again with the engine running or the ignition switched on as soon as it is in the vehicle interior. The logon data of up to four mobile phones can be stored simultaneously. If several mobile phones are detected simultaneously, the respective last mobile phone paired can be operated via the vehicle.

Using a phone in your vehicle

Using snap-in adapter*

The so-called snap-in adapter, a mobile phone cradle, enables the battery to be charged and the mobile phone to be connected to the external antenna of your vehicle. This ensures improved network reception and a consistent voice reproduction quality. Ask your BMW center which mobile phones snap-in adapters are offered for.

For your safety

A car phone makes life more convenient in many ways, and can even save lives in an emergency. While you should consult your mobile phone's separate operating instructions for a detailed description of safety precautions and information, we request that you direct your particular attention to the following:

 Only make entries when traffic conditions allow you to do so. Do not hold the mobile phone in your hand while you are driving; use the hands-free system instead. If you do not observe this precaution, your being distracted can endanger vehicle occupants and other road users. ◀

Suitable mobile phones

Ask your BMW center which mobile phones with a Bluetooth interface are supported by the mobile phone preparation package or which mobile phones snap-in adapters are available for. These mobile phones support the functions described in this Owner's Manual with a certain software version. Malfunctions can occur with other mobile phones.

Care instructions

You can find valuable information on this topic under Care, starting on page 239 and the operating instructions for the mobile phone.

Operating options

You can operate the mobile phone* using:

- ▷ Buttons on steering wheel, refer to page 11
- ▷ iDrive, refer to page 16
- ▷ Voice commands, refer to page 205
- ▷ Programmable memory buttons, refer to page 22

Avoid operating a mobile phone detected by the vehicle with the keypad of the mobile phone, otherwise malfunctions can occur.

Placing phone calls with BMW Assist system*: BMW Assist calls

You can use the BMW Assist system via the hands-free unit for BMW Assist calls.

When the status information "BMW Assist" or "BMW Service" is displayed in "Communication", only BMW Assist calls are possible.

It may not be possible to establish a telephone connection using the mobile phone while a connection is being established to BMW Assist or while a call to BMW Assist is already in progress. If this happens, you must log off the

mobile phone from the vehicle if you wish to place a call with the mobile phone.

Commissioning

Pairing mobile phone in vehicle

The following prerequisites must be met:

- ▶ Suitable mobile phone: the mobile phone is supported by the full mobile phone preparation package. Information on this subject is also provided on the Internet at: www.bmw.com
- ▶ The mobile phone is ready to operate.
- ▶ The Bluetooth link on the vehicle, refer to page 199, and on the mobile phone is active.
- ▶ Depending on the mobile phone, the mobile phone may need presetting: e.g. using the following menu items:
 - ▶ Bluetooth activated
 - ▶ Connection must be allowed without requiring further confirmation
 - ▶ Reconnect
- ▶ Depending on the mobile phone model, the setting energy saving mode can, for example, result in vehicle failing to detect the paired mobile phone.
- ▶ For pairing purposes, define any 4-16-digit number as a Bluetooth passkey, e.g. 25081107. A long and complex number offers the best protection against unauthorized access. This Bluetooth passkey is no longer required after pairing is successful.
- ▶ The ignition is switched on.

 Only pair the mobile phone with the vehicle stopped, otherwise the passengers and other road users can be endangered due to a lack of attentiveness on the part of the driver. ◀

Switching on ignition

1. Insert the remote control as far as possible into the ignition lock.
2. Switch on the ignition by pressing the Start/ Stop button without depressing the brake or clutch pedal.

Preparation via iDrive

iDrive, for operating principle refer to page 16.

3. Press the **MENU** button to open the start menu.



4. Press the controller to open the **i** menu.
5. Select "Settings" and press the controller.



6. Select "Bluetooth" and press the controller.



7. Move the highlight marker to the second field from the top, select "Phone" and press the controller.



8. Select "Pair new phone" and press the controller.

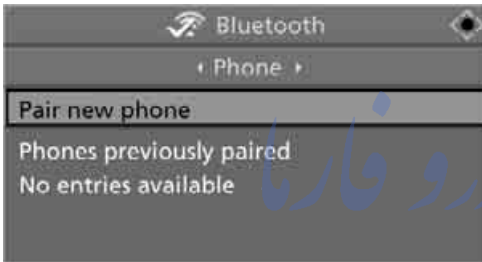

9. Select "Start pairing" and press the controller.



The Bluetooth name of the vehicle is displayed.

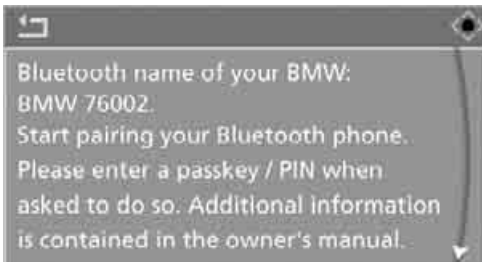

Preparation with mobile phone

10. Additional operations must be carried out on the mobile phone and differ depending on the model, refer to the operating instructions of your mobile phone, e.g. find, connect or pair under Bluetooth device. The Bluetooth name of the vehicle is also shown on the mobile phone display.
11. Select the Bluetooth name of the vehicle on the mobile phone display.

Pairing

Depending on your mobile phone, you will first be requested consecutively via the display of your mobile phone or iDrive to enter the Bluetooth passkey you specified.

12. Enter the Bluetooth passkey.

Depending on the mobile phone, approx. 30 seconds are available for entering the Bluetooth passkey on the mobile phone and on the Control Display.

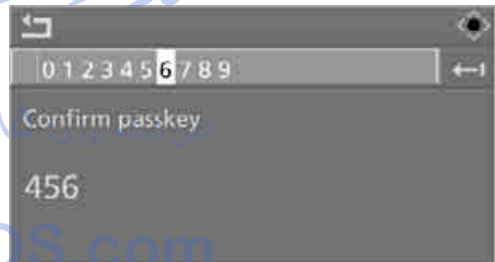

13. Move the highlight marker to the third field from the top, select "Confirm passkey" and press the controller.
14. Wait several seconds until the "Communication" menu is displayed.

The next time you use the mobile phone inside the vehicle, it will be recognized within a few minutes as long as the engine is running or the ignition is switched on.

- ▶ With some mobile phone models it may be necessary to make certain settings for a permanent Bluetooth link, e.g. via the menu item Authorization or Secure connection. Refer to the operating instructions of your mobile phone. ◀

As soon as a mobile phone is detected by the vehicle, the phone book entries stored on the SIM card or on your mobile phone are transmitted to your vehicle. This transmission is dependent on your mobile phone, refer to the operating instructions of your mobile phone if necessary, and can take several minutes.

If not all phone book entries are displayed:

- ▶ Transfer all phone book entries from the SIM card to the mobile phone if necessary.
- ▶ It may not be possible to display phone book entries with special characters.

Up to four mobile phones can be paired consecutively. When you pair a fifth mobile phone, the pairing data of the mobile phone for which the pairing data were stored first in the vehicle will be deleted.

Checking if pairing is unsuccessful

- ▶ Is the mobile phone supported by the mobile phone preparation package? Information on this subject is also provided on the Internet at: www.bmw.com.
- ▶ Do the Bluetooth passkeys on the mobile phone and the vehicle match? The same Bluetooth passkey must be entered both on the mobile phone display and via iDrive.
- ▶ Have you required longer than 30 seconds to enter the Bluetooth passkey?
- ▶ Only a limited number of devices can be connected to the mobile phone. Delete the connection to other devices if necessary.
- ▶ The mobile phone no longer reacts? Switch the mobile phone off and then on again or disconnect the power supply.

To repeat pairing:

1. Select "Restart pairing" and press the controller.

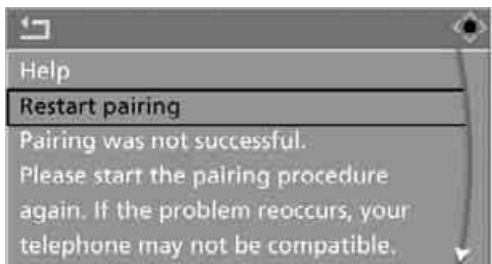

2. Repeat steps 9 to 14.

If pairing was repeatedly unsuccessful, contact BMW Customer Relations.

To call BMW Customer Relations:

Select "Help" and press the controller.

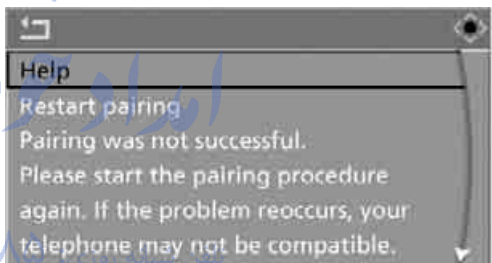

The phone number of BMW Customer Relations and information required for pairing is shown on the display. With mobile phones already paired, you can select the phone number of BMW Customer Relations to establish the connection.



List of paired mobile phones

The mobile phones for which the vehicle has stored the pairing data can be displayed. If several paired mobile phones are detected by the

vehicle simultaneously, you can operate the mobile phone highest up in the list via the vehicle.

You can change the order of the mobile phones in the list. As long as a mobile phone is selected in this list, the mobile phones cannot be operated via the vehicle.

iDrive, for operating principle refer to page 16.

1. Press the **MENU** button to open the start menu.
2. Press the controller to open the **i** menu.
3. Select "Settings" and press the controller.
4. Select "Bluetooth" and press the controller.
5. Move the highlight marker to the second field from the top, select "Phone" and press the controller.
6. Select the desired mobile phone.

With two drives:

- ▷ Move the controller backwards to change into the bottom field.
- ▷ Select the desired mobile phone and press the controller.

With a single drive:

- ▷ Select the desired mobile phone and press the controller.

7. Select "Move device up" and press the controller.



The selected mobile phone is moved upward by one position.

Unpairing mobile phone from vehicle

If you no longer want to operate a mobile phone via the vehicle, you can delete the pairing data of the mobile phone.

iDrive, for operating principle refer to page 16.

1. Switch off the mobile phone.
2. Press the **MENU** button to open the start menu.
3. Press the controller to open the **i** menu.
4. Select "Settings" and press the controller.
5. Select "Bluetooth" and press the controller. "Bluetooth" is selected.
6. Move the highlight marker to the second field from the top, select "Phone" and press the controller.
7. Select the desired mobile phone.

With two drives:

- ▷ Move the controller backwards to change into the bottom field.
- ▷ Select the desired mobile phone and press the controller.



With a single drive:

- ▶ Select the desired mobile phone and press the controller.



- 8. Select "Delete device" and press the controller.

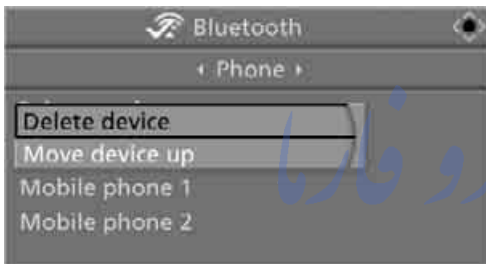

The unpaired mobile phone is deleted from the list.

The phone book entries and the lists of stored phone numbers are also deleted.

Activating/deactivating Bluetooth link

▶ Bluetooth technology is not approved in all countries. Observe the applicable local regulations. Temporarily deactivate the Bluetooth link between the vehicle and the mobile phone if necessary.

If the Bluetooth link is deactivated, you cannot operate your mobile phone via the vehicle and other devices with a Bluetooth interface can be used via the mobile phone, e.g. a laptop computer. ◀

To temporarily deactivate the Bluetooth link between the vehicle and your mobile phone:

1. Press the **MENU** button to open the start menu.
2. Press the controller to open the **i** menu.
3. Select "Settings" and press the controller.

4. Select "Bluetooth" and press the controller.



5. Move the highlight marker to the second field from the top, select "Settings" and press the controller.

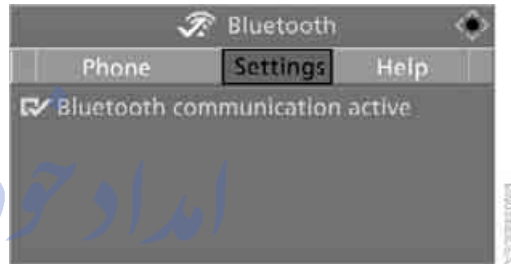

6. Select "Bluetooth communication active" and press the controller to activate or deactivate the link.

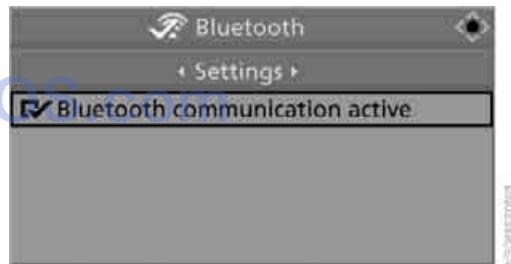

- The Bluetooth link is activated.
- The Bluetooth link is deactivated.

Adjusting volume



Turn the knob during a call to select the desired volume.

This volume for the hands-free system is maintained, even if the other audio sources are set to minimum volume.

You can also adjust the volume with the buttons on the steering wheel, refer to page 11.

The setting is stored for the remote control currently in use.

Operation via iDrive

You can operate the following functions via iDrive:

- ▷ Accepting/refusing a call
- ▷ Dialing phone numbers
- ▷ Dialing phone numbers from the phone book
- ▷ Dialing stored phone numbers, e.g. from the list of accepted calls.
- ▷ Ending a call

When the ignition is switched off or in radio readiness, e.g. after taking the remote control out of the ignition lock, you can continue an ongoing call via the hands-free system for several minutes.

Speech quality

If the person you are talking to cannot understand you well, this may be due to excessively loud background noises. The full mobile phone preparation package can compensate for these noises to a certain degree. To optimize the

speech quality during a call, we recommend that you:

- ▷ Reduce background noises, e.g. by closing the windows, reducing the air volume of the automatic climate control or pointing the opened front vent outlets downward
- ▷ Reduce volume of hands-free system

Requirements

- ▷ The logon data of the mobile phone are stored in the vehicle and the mobile phone is ready to operate.
- ▷ The engine is running or the ignition is switched on.
- ▷ The mobile phone is detected by the vehicle.

Opening Communication

Many of the functions described below are controlled using the "Communication" menu.

iDrive, for operating principle refer to page 16.

1. Press the **MENU** button to open the start menu.



2. Move the controller forward to open "Communication".

Receiving calls

If you have the phone number of the caller stored in the phone book and the phone number has been transmitted, the name of the entry is displayed.

Accepting a call

Press the  button on the steering wheel.

Alternative:

"Accept" is selected.
Press the controller.

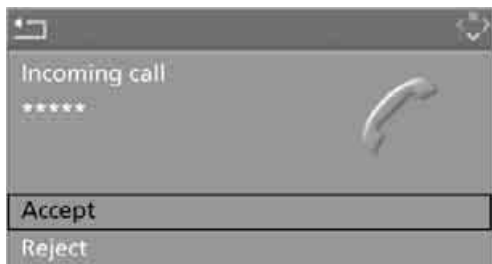

4. Select "Dial number" and press the controller.



Rejecting a call

Select "Reject" and press the controller.
The caller is diverted to your mailbox if it has been activated.

Calling

Dialing phone numbers

1. Select "Phone" and press the controller.

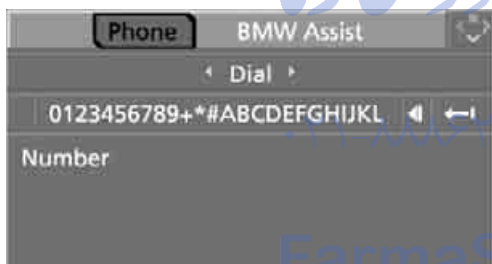

2. Select "Dial" and press the controller.
3. Enter the desired phone number by dialing the individual digits and pressing the controller.

Always enter the complete phone number consisting of national dialing code, area code, and phone number.

The letters correspond to the digits on the keypad of the mobile phone.

To delete the last digit:

Move the controller toward the right to select the arrow ← and press the controller.

Alternative:

Press the  button on the steering wheel.

For your phone number to be displayed to the person you are calling, the display of phone numbers must be enabled by your service provider.

About programmable memory buttons

You can store and request phone numbers using the programmable memory buttons, refer to page 22.

Ending a call

Press the  button on the steering wheel.

Alternative:

1. Select the phone number and press the controller.

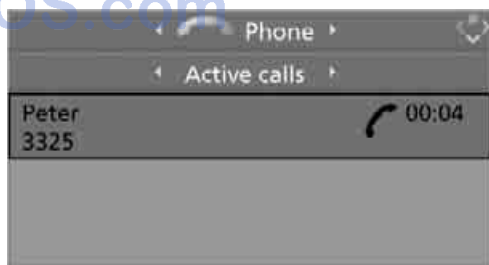

- "End call" is selected:
Press the controller.



Dialing a phone number from phone book or a phone number stored in a list

Phone numbers you have called, incoming calls and the entries of the phone book are stored in lists when the mobile phone is connected to the vehicle via Bluetooth. If the caller is entered in the phone book, the name of the entry is displayed instead of the phone number.

You can select the desired subscriber from the list and establish the connection.

Five lists are available:

- ▷ "A - Z"
The entries in your mobile phone's phone book, consisting of names and phone numbers, are sorted alphabetically.
- ▷ "Top 8"
The eight numbers dialed most frequently from the "A - Z" phone book are automatically stored in the Top 8 list.
- ▷ "Redial"
The last eight phone numbers you dialed are automatically stored. The last number dialed is at the top of the list.
- ▷ "Missed calls"
The phone numbers of the last eight calls that were not accepted are stored. This requires the telephone number of the caller to have been sent.
- ▷ "Received calls"
The phone numbers of the last eight accepted calls are stored. This requires the telephone number of the caller to have been sent.

Dialing a phone number from phone book

The "A - Z" list is available for your phone book entries. The phone book entries appear on the Control Display.

- Select "Phone" and press the controller.



- Select "A - Z" and press the controller.
- To limit the number of displayed entries, select the first letter of the desired entry and press the controller.
- Select the desired entry and press the controller.

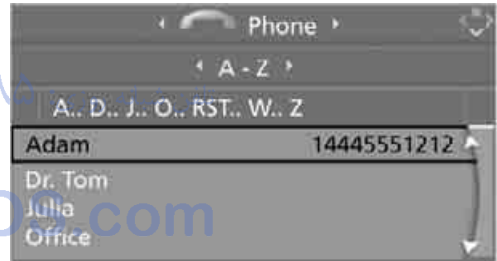

- Select "Call" and press the controller.
The system dials the number.

If different phone numbers are stored in the mobile phone under one name, e.g. office and home, the name is shown once for each phone number.

You can change a phone number stored in the phone book, e.g. to call a specific extension:

- Select "Phone" and press the controller.
- Select "A - Z" and press the controller.
- Select the desired entry and press the controller.
- Select "Add digits" and press the controller.
- Change the phone number.

6. Select "Dial number" and press the controller.

Dialing a phone number stored in a list

To select an entry and establish a connection:

1. Select "Phone" and press the controller.
2. Select list and press the controller:
 - ▷ "Top 8"
 - ▷ "Redial"
 - ▷ "Missed calls"
 - ▷ "Received calls"



3. Select the desired entry and press the controller.



4. Select "Call" and press the controller.
The system dials the number.

Deleting individual entries

1. Select the desired entry from the list and press the controller.
2. Select "Delete" and press the controller.



The entry is deleted.

Deleting entire list

1. Select an entry from the list and press the controller.
2. Select "Delete all numbers" and press the controller.



3. If applicable, select "Yes" and press the controller.
The list is deleted.

BMW Contact*

If you are not enabled for BMW Assist, you can have several service phone numbers displayed:

- ▷ BMW Roadside Assistance* when you require breakdown assistance
- ▷ BMW center, e.g. when you want to make an appointment for service
- ▷ BMW Customer Relations* for information on all aspects of your vehicle

If BMW Assist is enabled, refer to page 209.

You can dial the displayed service phone numbers if your mobile phone is paired in the vehicle:

iDrive, for operating principle refer to page 16.

1. Press the **MENU** button.
This opens the start menu.
2. Move the controller forward to select "Communication".
3. Select "BMW Contact" and press the controller.



4. Select "BMW Contact Numbers" and press the controller.



5. Select one of the following menu items and press the controller:
 - ▷ "Roadside Assistance"
 - ▷ "Customer Relations"
 - ▷ "Service Request"

6. Select "Call" and press the controller.

Contact is established.

Transmitting phone number via tone dialing method

The tone dialing method is required for access to network services or for controlling devices, e.g. remote checking of an answering machine.

This function is available when a connection has been established.

1. Establish connection.



2. With a single drive:
Press the controller.
Select "Keypad" and press the controller.
With two drives:
Move the controller backwards until the bottom field is selected.
3. Select the desired character and press the controller.
Each character is sent immediately and confirmed by a tone depending on the mobile phone model.



Changing between mobile phone and hands-free system

From mobile phone to hands-free system*

You can continue calls begun outside the Bluetooth range of the vehicle via the hands-free system when the motor is running or the ignition is switched on. Depending on your mobile phone, the system automatically changes over to the hands-free mode.

For mobile phones that do not automatically change over to the hands-free mode:

Depending on the mobile phone model used, the conversation can be continued via the hands-free system if necessary. Refer to the display on your mobile phone and/or your mobile phone's operating instructions.

From hands-free system to mobile phone

When you telephone via the hands-free system, you can also continue the call via the mobile phone if necessary, depending on the mobile phone model. Act according to what is shown on the mobile phone display, refer to the operating instructions of your mobile phone.

As an alternative, you can deactivate the Bluetooth link.

Depending on your mobile phone model, poor reception of the wireless communications network can result in the system changing from the hands-free system to the mobile phone.

Operation by voice*

The concept

You can operate your mobile phone without having to remove your hands from the steering wheel. When making your entries, you will be supported by announcements or questions in many cases.

The same prerequisites as for operation via iDrive apply, refer to page 200.

Example: Dialing phone numbers

To start the dialog:

Press the  button on the steering wheel.

You say	The voice control answers
>Dial number<	>>Please say the number<<
e.g. >123 456 7890<	Depending on equipment: >>123 456 7890. Continue?<<< or >>123 456 7890. And next?<<
>Dial<	>>Dialing number<<

Voice commands

Activating system

1. Briefly press the  button on the steering wheel.
An acoustic signal indicates that you can say commands.
2. Say the command.

Ending/canceling operation by voice

Press the  button on the steering wheel or

 >Cancel<.

In dialogs where text is spoken, not a command, e.g. a name, canceling is only possible using the button on the steering wheel.

Having possible commands read aloud

The system understands default commands that must be spoken word for word.

You can have the possible commands spoken by the system at any point:

 >Help<.

Using alternative commands

There are often a number of commands to run a function, e.g.:

 >Dial name< or >Name<.

The system recognizes digits from zero to nine.

You can say each digit individually or group them into a sequence to accelerate the input.

Setting volume of instructions

You can adjust the volume for the instructions from the system:



Turn the knob during instructions.

This volume for the instructions is maintained, even if the other audio sources are set to minimum volume.

The setting is stored for the remote control currently in use.

Calling

Dialing phone numbers

1. ›Dial number‹.
2. Say the phone number.
For telephone calls abroad, say ›Plus‹ and then the country code.
3. ›Dial‹.

The connection to the desired subscriber is established.

Correcting phone number

After the last spoken sequence of digits has been repeated by the system, you can delete this sequence of digits.

- ›Correct number‹.
The digits are deleted.

The command ›Correct number‹ can be repeated as often as you like.

Deleting phone number

- ›Delete‹

All digits entered up to this point are deleted.

Voice phone book

Operating by voice command requires a personal voice phone book.

- ▷ With separate drives for audio CDs and navigation DVDs, the entries are automatically adopted from your mobile phone's memory.
- ▷ With a single drive, the entries must be input by voice and are independent of your mobile phone's memory. In this case, it is not possible to use voice command either to call phone numbers stored in the mobile phone or to store new numbers. Up to 50 entries can be set up. An entry always consists of a name and phone number.

Creating and editing voice phone book*

Store entry:

An entry always consists of a name and phone number.

1. ›Save name‹.
2. Speak the name.
The spoken length of the names in the phone book must not exceed approx. 2 seconds.
3. Speak the phone number after being requested to do so by the system.
4. To store the phone number:
›Save‹.

Delete entry:

You can delete any entry from the voice phone book.

1. ›Delete name‹.
The dialog for deleting an entry is opened.
2. Say the name when prompted.
3. Confirm the prompt with ›Yes‹.

Delete all entries:

›Delete phone book‹ deletes all entries in the phone book.

1. ›Delete phone book‹.
The dialog for deleting phone book is opened.
2. Confirm the prompt with ›Yes‹.
3. Confirm the repeated prompt with ›Yes‹.

Have entries read aloud and select:

You can have all the entries of your voice phone book read aloud in the order of input and select a certain entry to establish a connection:

1. ›Read phone book‹.
The dialog for reading phone book is opened.
2. ›Dial number‹ when the desired entry is read aloud.

Selecting an entry

The connection to the phone number of the selected entry is established.

1. ›Dial name‹.
The dialog for selecting an entry is opened.
2. Say the name when prompted.
3. Confirm the prompt with ›Yes‹.

Redialing

The ›Redial‹ command opens "Redial".

Notes

Important for voice commands

For voice commands, keep the following in mind:

- ▶ Issue the commands smoothly and at normal volume, avoiding excessive emphasis and pauses.
- ▶ Keep the doors, windows and glass sunroof closed to prevent interference from ambient noise.
- ▶ Avoid making other noise in the vehicle while speaking.

Snap-in adapter inserting/removing*

1. Press the area **1** around the button and remove the cover.

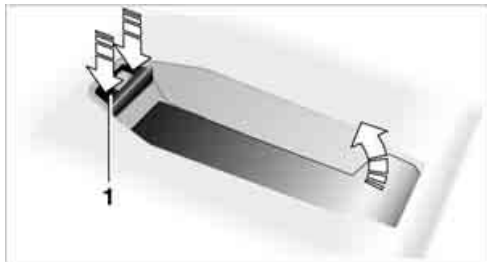

2. Insert the snap-in adapter at the front and press down until it engages.



To remove the snap-in adapter:
Press the area **1** around the button.



Inserting mobile phone

1. Remove the protective cap from the mobile phone's antenna connector if necessary, so

that the mobile phone can engage in the snap-in adapter.

2. Push the mobile phone with the buttons facing upward toward the electrical connections and press down until it engages.

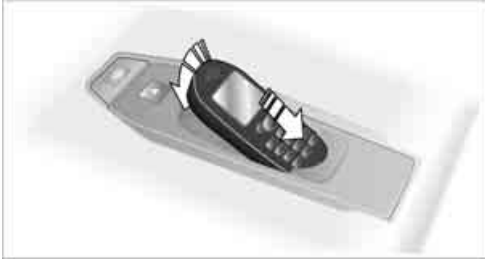

The mobile phone's battery is charged from radio readiness or with the steering unlocked.

 To protect the vehicle's batteries, avoid using the phone when the ignition is switched off. ◀

Removing mobile phone

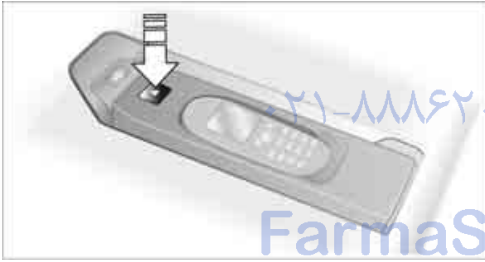

Press button.

امداد خودرو فارس
تلفن شبانه روزی: ۲۱-۸۸۶۲۰۸۵
FarmaSOS.com

BMW Assist provides you with various services. For example, the position data of your vehicle can be transmitted to the BMW Assist Response Center if an emergency request* has been initiated.

Many BMW Assist services depend on the individually agreed contract.

After your contract has expired, the BMW Assist system will be deactivated by the BMW Assist Response Center without you having to visit a BMW center. After the BMW Assist system has been deactivated, no BMW Assist service will be available. The BMW Assist system can be reactivated by a BMW center after signing a new contract.

Requirements

You can use BMW Assist when the following requirements are met:

- ▷ The installed BMW Assist system is logged on to a mobile phone network. This network must be capable of transmitting the services.
- ▷ To transmit position data, the vehicle must be able to determine the current position.
- ▷ In order to activate and update BMW Assist, a GPS signal must be available.
- ▷ You have subscribed to BMW Assist with your BMW center or with the BMW Assist Response Center. Activation must be completed.
- ▷ BMW Assist is activated, refer to page 215.

Offered services

The following services are available via BMW Assist:

- ▷ Emergency request, refer to page 253: When you press the SOS button, a connection is established to the BMW Assist Response Center. The BMW Assist

Response Center contacts you and takes further steps to help you.

- ▷ Automatic collision notification: Under certain conditions, a connection is established to the BMW Assist Response Center immediately after a serious accident. If possible, the BMW Assist Response Center contacts you and takes further steps to help you.
- ▷ Enhanced roadside assistance: You can call Roadside Assistance* of the BMW Group should you require help in the event of a breakdown. If possible, the vehicle data and position data are transmitted during this time.
- ▷ BMW Customer Relations: For information related to your vehicle, call BMW Customer Relations.
- ▷ BMW Assist My Info: Using the BMW Assist Internet portal, you can transmit addresses and text messages into the vehicle and have them displayed.
- ▷ BMW TeleServices*: The data on the service status of your vehicle or on required inspections are transmitted to your BMW center either automatically prior to the due date or when you request a BMW service appointment.
- ▷ Remote door unlock: Inform the BMW Assist Response Center, e.g. if your remote control is not available and you want to have the vehicle unlocked.
- ▷ Stolen vehicle recovery: After your vehicle has been reported to the police as stolen, the BMW Assist Response Center can locate its position.

In addition, you can be provided with other services, e.g. the concierge service or information on route planning, traffic conditions, and the weather. With Critical Calling, you can make a limited number of calls via the BMW Assist Response Center, e.g. if you do not have your mobile phone with you.

Press the SOS button to contact the BMW Assist Response Center, see below.

You also have access to the BMW Assist concierge service via the Internet.

Characteristics of the offered services

The following characteristics apply to the services:

- ▷ The offered services are country-specific.
- ▷ Voice contact is established or data are transmitted, depending on the equipment and the country. In some countries, it is possible to do both.
- ▷ The data transmitted can, for example, be the vehicle data, your current position or the CBS Condition Based Service data.

Using services

Contacting BMW Assist Response Center

You can contact the BMW Assist Response Center via the SOS button.

1. Briefly press protective cover to open. Depending on the vehicle's equipment, the arrangement of the switches and indicator lamps may differ somewhat.



2. Press the button for at least 2 seconds. The BMW Assist Response Center is contacted.

Roadside assistance

iDrive, for operating principle refer to page 16.

1. Press the **MENU** button. This opens the start menu.



2. Move the controller forward to select "Communication".
3. Change to upper field if necessary. Turn the controller until "BMW Assist" is selected and press the controller.

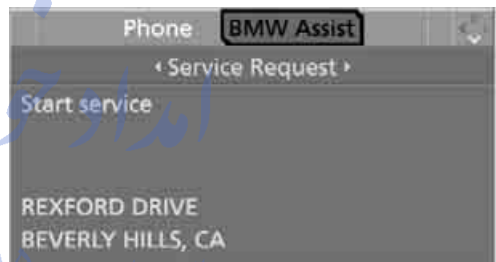

4. Select "Roadside Assistance" and press the controller.

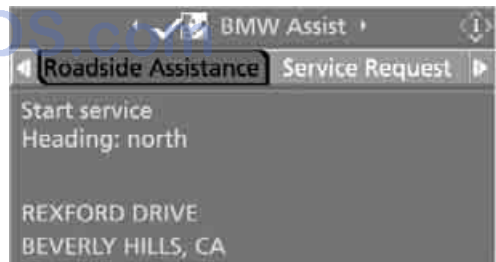

If the location can be determined, the current vehicle position is displayed.

5. Select "Start service" and press the controller.

The BMW Assist Response Center will connect you to the Roadside Assistance of the BMW Group.

BMW TeleServices*

Automatic service notification*

The data on the service status of your vehicle or on required inspections are transmitted automatically prior to the due date. You can check when the BMW center was notified.

1. Press the **MENU** button.
This opens the start menu.
2. Press the controller to open the **i** menu.
3. Select "Info sources" and press the controller.



4. Select "Service Info" and press the controller.
5. Change to upper field if necessary. Turn the controller until "Service requirements" is selected and press the controller.

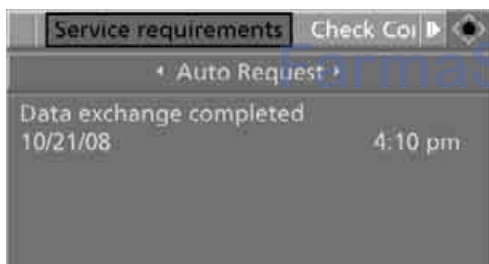

6. Select "Auto Request" and press the controller.

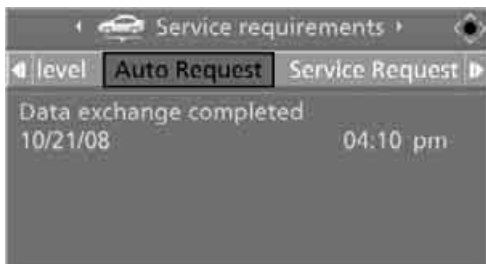

Manual service notification

You can transmit data regarding your vehicle's service status to your BMW center when you wish to arrange a service appointment.

1. Press the **MENU** button.
This opens the start menu.
2. Move the controller forward to select "Communication".
3. Change to upper field if necessary. Turn the controller until "BMW Assist" is selected and press the controller.

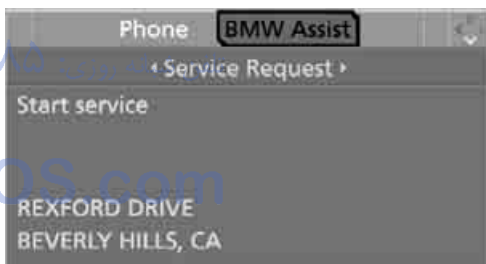

4. Select "Service Request" and press the controller.

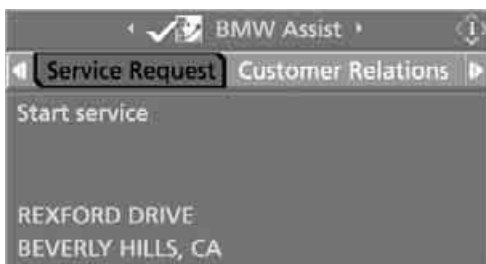

5. Select "Start service" and press the controller.

The data relevant for service are transmitted. Your BMW center will contact you to set up an appointment for service.

Displaying and updating BMW TeleServices services*

1. Press the **MENU** button. This opens the start menu.
2. Press the controller to open the **i** menu.
3. Select "Settings" and press the controller.



4. Select "BMW Service settings" and press the controller.

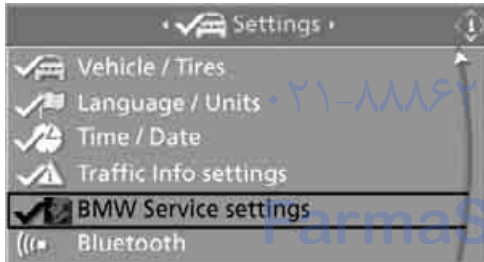

5. Select "Enabled TeleServices" and press the controller.



The activated BMW Assist services are displayed.

6. Select "Options" and press the controller.

7. Select "Update services" and press the controller.

Contacting BMW Customer Relations

For information on all aspects of your vehicle, you can contact BMW Customer Relations.

1. Press the **MENU** button. This opens the start menu.
2. Move the controller forward to select "Communication".
3. Change to upper field if necessary. Turn the controller until "BMW Assist" is selected and press the controller.

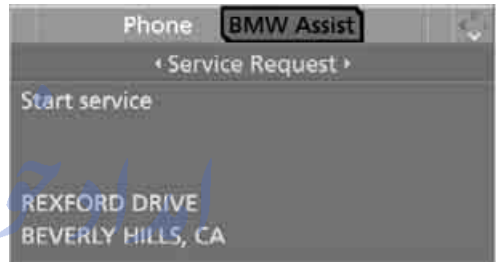

4. Select "Customer Relations".

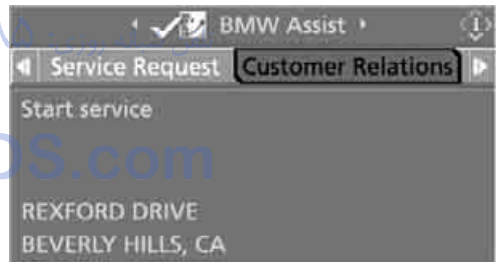

5. Press the controller.
6. Select "Start service" and press the controller.

You will be connected to BMW Customer Relations by the BMW Assist Response Center.

Concierge service*

When you call the concierge service of BMW Assist, you can, for example, obtain information on current events, filling stations or hotels and have their phone numbers and addresses transmitted. Many hotels can be booked

directly through the BMW Assist concierge service.

The concierge service must be enabled separately by the BMW Assist Response Center.

Calling up information

1. Press the **MENU** button.
This opens the start menu.
2. Move the controller forward to select "Communication".
3. Change to upper field if necessary. Turn the controller until "BMW Assist" is selected and press the controller.



4. Select "Concierge" and press the controller.

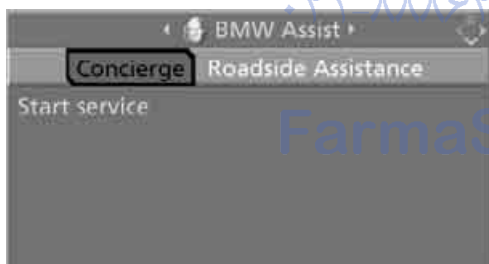

5. Select "Start service" and press the controller.

The BMW Assist Response Center will connect you with a BMW Assist concierge.

Displaying transmitted data

Select the received message if necessary and press the controller.

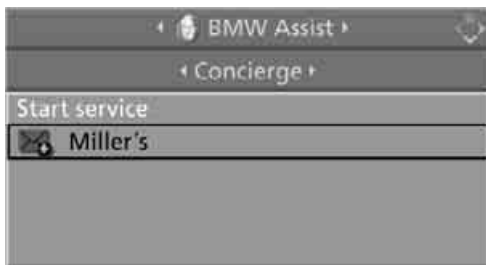

Dialing a phone number or transferring an address for destination guidance

1. Select "Options" and press the controller.

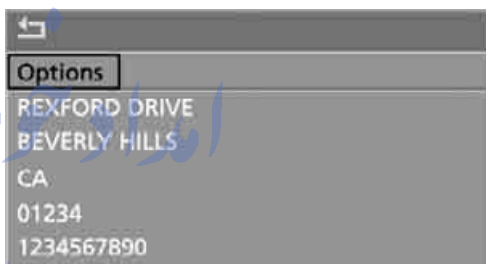

2. Select a menu item:
 - ▷ Press "Call" to make a telephone call. A prerequisite for this is that your Bluetooth mobile phone has been paired with the vehicle.
 - ▷ Press "Select as destination" to transfer the address to the navigation system for destination guidance.

BMW Assist My Info*

Using the BMW Assist Internet portal, you can transmit addresses and phone numbers into the vehicle using text messages.

1. Press the **MENU** button.
This opens the start menu.
2. Move the controller forward to select "Communication".
3. Change to upper field if necessary. Select "BMW Assist" and press the controller.

4. Select "My Info" and press the controller.



The transmitted messages are automatically displayed.

You can receive and display up to a maximum of ten messages. Additional messages can only be received once old messages have been deleted.

In order to display an existing message: Select message and press the controller.

If you have received a message with a phone number, then you can send it to your mobile phone provided that your phone has been paired with the vehicle.

If you have received a message with an address, then you can send it to your navigation system*.

1. Select message and press the controller.
2. Select "Options" and press the controller.
3. Select the desired menu item:
 - ▷ To dial a received phone number, select "Call" and press the controller.
 - ▷ If your vehicle has a navigation system: To adopt a received destination address into the navigation system, select "Select as destination" and press the controller.
 - ▷ To delete a received message, select "Delete" and press the controller.

Updating BMW Assist

Displaying and updating services

You will be notified of any changes in the services offered by BMW Assist. In this case you should update the service functions.

1. Press the **MENU** button.
This opens the start menu.
2. Press the controller to open the **i** menu.
3. Turn the controller until "Settings" is selected and press the controller.



4. Turn the controller until "BMW Service settings" is selected and press the controller.

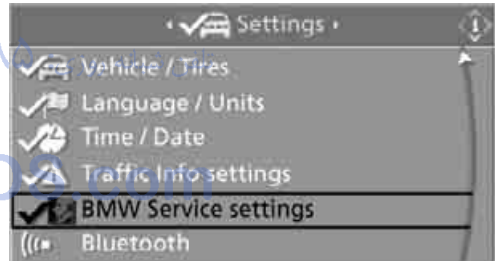

5. Change to upper field if necessary. Turn the controller until "Enabled Assist services" is selected and press the controller.
The currently available BMW Assist services are displayed.

- If applicable, select "Options" and press the controller.

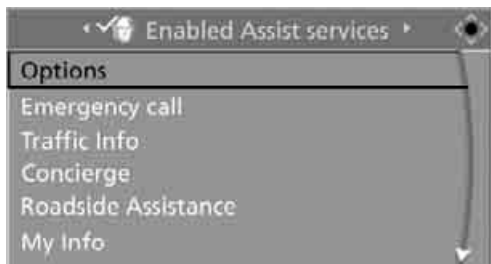

- Select "Update services" and press the controller.

Activating BMW Assist

BMW Assist must be activated to use the services.

Requirements

- Make sure that the vehicle can determine its current position. Reception is best when you have an unobstructed view to the sky.
- Leave the ignition switched on during the activation process.

Activating

- Press the **MENU** button. This opens the start menu.



- Press the controller to open the **i** menu.

- Turn the controller until "Settings" is selected and press the controller.



- Turn the controller until "BMW Service settings" is selected and press the controller.



- Change to upper field if necessary. Turn the controller until "Enabled Assist services" is selected and press the controller.

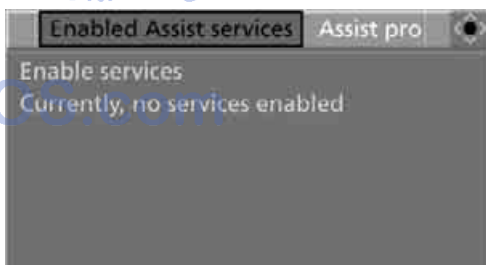

- Select "Enable services" and press the controller. BMW Assist is enabled and the data

exchange with the BMW Assist Response Center begins.



4. Select "BMW Service settings" and press the controller.

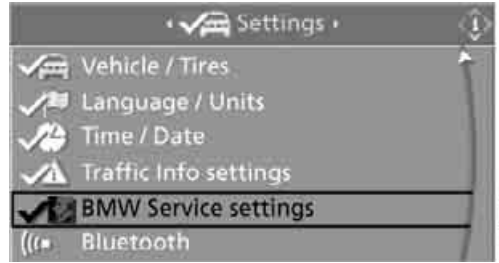

Activation takes a few minutes. The status is displayed on the Control Display. If you open another menu, the activation process continues to run in the background.

5. Change to upper field if necessary. Turn the controller until "Profile" is selected and press the controller.



Displaying vehicle data

With BMW Assist activated, you can have the Telematics ID displayed. The Telematics ID is used to identify your vehicle. These data are transmitted to the service.

1. Press the **MENU** button.
This opens the start menu.



2. Press the controller to open the **i** menu.
3. Turn the controller until "Settings" is selected and press the controller.



امداد خودرو فارما

تلفن شبانه روزی: ۰۲۱-۸۸۸۶۲۰۸۵

FarmaSOS.com



امداد خودرو فارما

تلفن شبانه روزی: ۰۲۱-۸۸۸۶۲۰۸۵

FarmaSOS.com

Mobility

This section helps you maintain your car's mobility by supplying important information on vital topics, including fuels and lubricants, wheels and tires, service, maintenance and breakdown assistance.

امداد خودرو فارما

تلفن شبانه روزی: ۰۲۱-۸۸۸۶۲۰۸۵

FarmaSOS.com

Refueling

 Switch off the engine before refueling, otherwise no fuel can be filled into the tank and a message is displayed. ◀

 When handling fuel, always observe all applicable precautionary measures and regulations. Never transport reserve fuel containers in the vehicle. These could become leaky and cause an explosion or a fire in an accident. ◀

Fuel filler door



To open and close: press the rear edge of the fuel filler door.

Manual release

If an electrical malfunction should occur, you can unlock the fuel filler door manually.

Sedan

1. In the cargo bay, raise the floor mat and the cover located beneath it.
2. Open the snap fasteners of the right side panel and take off the side panel.

3. Pull the knob with the gas pump symbol.

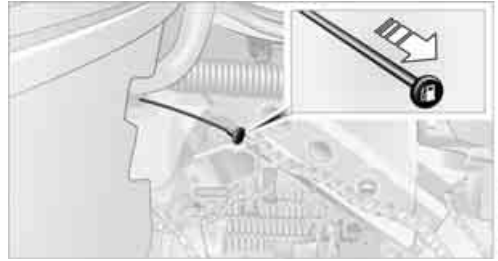

Sports Wagon

1. Unhook the retaining strap*, refer to page 129.
2. Open the right-hand side panel in the cargo bay.
3. Pull the knob with the gas pump symbol.



Observe the following when refueling

 When handling fuels, follow the safety precautions posted at the filling station. Otherwise, there is a danger of personal injury or property damage. ◀

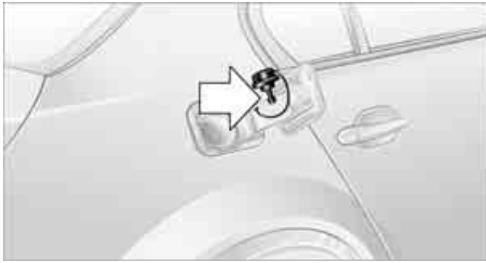

Place the fuel filler cap in the bracket attached to the fuel filler door.

When refueling, insert the filler nozzle completely into the filler pipe. Avoid raising the filler nozzle during refueling, otherwise this leads to

- ▷ premature pump shutoff
- ▷ a reduced efficiency of the fuel-vapor recovery system.

The fuel tank is full when the filler nozzle clicks off the first time.

Fuel tank capacity

Approx. 18.5 US gal/70 liters, including approx. 2.1 US gal/8 liters reserve capacity.
550i: approx. 2.6 US gal/10 liters reserve capacity.

 Refuel as soon as possible once your cruising range falls below 30 miles/50 km, otherwise engine functions are not ensured and damage can occur. ◀

Fuel filler cap

Closing

Fit the cap and turn it clockwise until you clearly hear a click.

 Do not crush the band attached to the cap; otherwise, the cap may not properly seal and fuel vapors can escape. ◀

A message* is displayed if the cap is loose or missing.

Fuel specifications

 Do not use leaded gasoline, otherwise permanent damage to the catalytic con-

verter will result.

Do not use E85, i.e. fuel that consists of 85 % ethanol, or Flex Fuel. Otherwise permanent damage to the engine and the fuel supply system will result. ◀

Required fuel

Super Premium Gasoline/AKI 91

This gasoline is highly recommended.

However, you may also use gasoline with less AKI. The minimum AKI Rating is 87.

If you use gasoline with this minimum AKI Rating, the engine may produce knocking sounds when starting at high outside temperatures. This has no effect on the engine life.

 Do not use gasoline below the specified minimum quality, otherwise engine damage can result. ◀

Use high-quality brands

Field experience has indicated significant differences in fuel quality: volatility, composition, additives, etc., among gasolines offered for sale in the United States and Canada. Fuels containing up to and including 10% ethanol or other oxygenates with up to 2.8% oxygen by weight, that is, 15% MTBE or 3% methanol plus an equivalent amount of co-solvent, will not void the applicable warranties with respect to defects in materials or workmanship.

 The use of poor-quality fuels may result in drivability, starting and stalling problems especially under certain environmental conditions such as high ambient temperature and high altitude.

Should you encounter drivability problems which you suspect could be related to the fuel you are using, we recommend that you respond by switching to a recognized high-quality brand such as gasoline that is advertised as Top Tier Detergent Gasoline.

Failure to comply with these recommendations may also result in unscheduled maintenance. ◀

Wheels and tires

Tire inflation pressure

Information for your safety

The condition of the tires and the maintenance of the specified tire pressure are crucial not only to the tire's service life, but also to driving comfort and most importantly, driving safety.

Checking pressure

Only check tire inflation pressure when the tires are cold. This means after a maximum of 1.25 miles/2 km driving or when the vehicle has been parked for at least 2 hours. When tires are warm, the tire inflation pressure increases.

⚠ Check the tire inflation pressure regularly and correct it as needed, even on the compact tire*: at least twice a month and before starting long trips. Otherwise driving instability or tire damage, and therefore accidents, can result from incorrect tire inflation pressures. Do not drive with depressurized, i.e. flat tires, except run-flat tires. A flat tire will seriously impair your vehicle's handling and braking response. Attempts to drive on a flat tire can lead to a loss of control over the vehicle. ◀

▶ After correcting the tire inflation pressure, reinitialize the Flat Tire Monitor, refer to page 95, or reset the Tire Pressure Monitor, refer to page 97. ◀

Pressure specifications

The tables below provide all the correct inflation pressures for the specified tire sizes at ambient temperature.

▶ The inflation pressures apply to the tire sizes and tire brands respectively approved and recommended by BMW; a list of these is available from your BMW center. ◀

For correct identification of the right tire inflation pressure for your tires, observe the following:

▶ Tire sizes of your vehicle

- ▶ Load conditions
- ▶ Maximum allowable driving speed

Tire inflation pressures for speeds up to 100 mph/160 km/h

For normal driving up to 100 mph/160 km/h, adjust pressures to the respective tire inflation pressures listed on the following pages in the column Traveling speeds up to max. 100 mph/160 km/h to achieve optimum driving comfort.

These pressure specifications can be found on the door post when you open the driver's door.

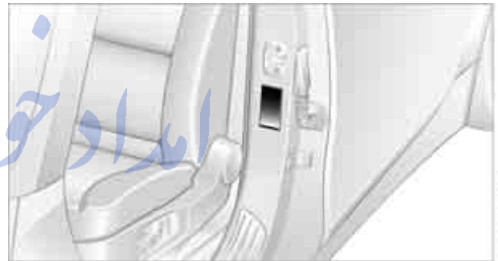



⚠ The maximum permissible speed for these tire pressures is 100 mph/160 km/h. Do not exceed this speed, otherwise tire damage and accidents could occur. ◀

Tire inflation pressures for speeds above 100 mph/160 km/h



⚠ In order to drive at maximum speeds in excess of 100 mph/160 km/h, please observe, and, if necessary, adjust tire pressures for speeds exceeding 100 mph/160 km/h from the relevant table on the following pages. Otherwise tire damage and accidents could occur. ◀

Observe all national and local maximum speed limits, otherwise violations of the law could occur.

Tire size	Pressure specifications in psi/kPa					
Compact wheel*: T 135/80 R 17 102 M	61/420					
	Traveling speeds up to max. of 100 mph/ 160 km/h			Traveling speeds including those exceeding 100 mph/160 km/h		
All pressure specifications in the table are indicated in psi/kilopascal with cold tires. Cold = ambient temperature						
245/45 R 17 95 W	32/220	33/230	32/220	33/230	35/240	42/290
245/45 R 17 99 V M+S XL						
225/50 R 17 94 V M+S						
225/50 R 17 94 W	32/220	36/250	32/220	35/240	36/250	44/300
245/40 R 18 93 W						
225/50 R 17 94 H M+S						
245/40 R 18 97 V M+S XL	32/220	38/260	32/220	38/260	38/260	45/310
Front: 245/40 R 18 93 W	32/220	33/230	32/220	33/230	36/250	42/290
Rear: 275/35 R 18 95 W						
Front: 245/35 R 19 93 Y XL	32/220	38/260	32/220	33/230	35/240	42/290
Rear: 275/30 R 19 96 Y XL						

More details on the permissible load and weights can be found on page [263](#).

FarmaSOS.com

Tire size	Pressure specifications in psi/kPa					
Compact wheel*: T 135/80 R 17 102 M	61/420					
	Traveling speeds up to max. of 100 mph/160 km/h			Traveling speeds including those exceeding 100 mph/160 km/h		
All pressure specifications in the table are indicated in psi/kilopascal with cold tires. Cold = ambient temperature						
245/45 R 17 95 W						
225/55 R 16 95 H M+S	32/220	35/240	32/220	33/230	35/240	42/290
245/45 R 17 99 V M+S XL						
225/50 R 17 94 M+S W						
225/50 R 17 94 W	32/220	36/250	32/220	35/240	38/260	45/310
225/50 R 17 94 H M+S						
245/40 R 18 93 W	32/220	38/260	32/220	35/240	38/260	45/310
245/40 R 18 97 V M+S XL	32/220	38/260	32/220	38/260	39/270	46/320
Front: 245/40 R 18 93 W						
Rear: 275/35 R 18 95 W	32/220	35/240	32/220	33/230	38/260	42/290
Front: 245/35 R 19 93 Y XL						
Rear: 275/30 R 19 96 Y XL	33/230	39/270	32/220	33/230	35/240	42/290
More details on the permissible load and weights can be found on page 263 .						



Tire size	Pressure specifications in psi/kPa					
Compact wheel*: T 135/80 R 17 102 M	61/420					
	Traveling speeds up to max. of 100 mph/ 160 km/h			Traveling speeds including those exceed- ing 100 mph/160 km/h		
All pressure specifications in the table are indicated in psi/kilopascal with cold tires. Cold = ambient temperature						
245/45 R 17 95 W	32/220	35/240	32/220	33/230	35/240	42/290
245/45 R 17 99 V M+S XL						
225/50 R 17 94 V M+S						
225/50 R 17 94 W						
225/50 R 17 94 H M+S	32/220	36/250	32/220	36/250	38/260	45/310
245/40 R 18 93 W						
245/40 R 18 97 V M+S XL						
Front: 245/40 R 18 93 W	32/220	35/240	32/220	33/230	38/260	42/290
Rear: 275/35 R 18 95 W						

More details on the permissible load and weights can be found on page [263](#).

تلفن شبانه روزی: ۰۲۱-۸۸۶۲۰۸۵



FarmaSOS.com

535i xDrive

Tire size	Pressure specifications in psi/kPa					
Compact wheel*: T 135/80 R 17 102 M	61/420					
	Traveling speeds up to max. of 100 mph/ 160 km/h			Traveling speeds including those exceeding 100 mph/160 km/h		
All pressure specifications in the table are indicated in psi/kilopascal with cold tires. Cold = ambient temperature						
245/45 R 17 95 W	32/220	35/240	32/220	33/230	35/240	42/290
245/45 R 17 99 V M+S XL						
225/50 R 17 94 W M+S						
225/50 R 17 94 W	32/220	36/250	32/220	36/250	38/260	45/310
225/50 R 17 94 H M+S						
245/40 R 18 93 W	33/230	36/250	33/230	36/250	38/260	45/310
245/40 R 18 97 V M+S XL	35/240	38/260	35/240	38/260	38/260	45/310
Front: 245/40 R 18 93 W	32/230	35/240	33/230	33/230	38/260	42/290
Rear: 275/35 R 18 95 W						



More details on the permissible load and weights can be found on page 263.

535i xDrive Touring تلفن شماره روزی: ۰۲۱-۸۸۶۲۰۸۵

Tire size	Pressure specifications in psi/kPa					
Compact wheel*: T 135/80 R 17 102 M	61/420					
	Traveling speeds up to max. of 100 mph/ 160 km/h			Traveling speeds including those exceeding 100 mph/160 km/h		
All pressure specifications in the table are indicated in psi/kilopascal with cold tires. Cold = ambient temperature						
225/50 R 17 94 W M+S						
225/50 R 17 94 W						
245/45 R 17 95 W	33/230	41/280	33/230	41/280	38/260	45/310
225/50 R 17 94 H M+S						
245/45 R 17 99 V M+S XL						
245/40 R 18 93 Y	32/220	39/270	32/220	38/260	35/240	42/290
245/40 R 18 97 V M+S XL	36/250	44/300	36/250	44/300	41/280	48/330

More details on the permissible load and weights can be found on page 264.

Tire size	Pressure specifications in psi/kPa
Compact wheel*: T 135/80 R 17 102 M	61/420

	Traveling speeds up to max. of 100 mph/160 km/h		Traveling speeds including those exceeding 100 mph/160 km/h			
All pressure specifications in the table are indicated in psi/kilopascal with cold tires. Cold = ambient temperature			 max. 			
245/40 R 18 93 Y	32/220	38/260	32/220	35/240	33/230	41/280
245/45 R 17 95 W						
245/45 R 17 99 V M+S XL	32/220	38/260	32/220	38/260	38/260	45/310
225/50 R 17 94 H M+S						
225/50 R 17 94 W						
245/40 R 18 97 V M+S XL	33/230	39/270	33/230	39/270	39/270	46/320
Front: 245/40 R 18 93 Y						
Rear: 275/35 R 18 95 Y	32/220	35/240	32/220	32/220	33/230	38/260
Front: 245/35 R 19 93 Y XL						
Rear: 275/30 R 19 96 Y XL	35/240	39/270	33/230	38/260	38/260	45/310

More details on the permissible load and weights can be found on page 263.

تلفن شبانه روزی: ۰۲۱-۸۸۶۲۰۸۵

Tire identification marks

Knowledge of the labeling on the side of the tire makes it easier to identify and choose the right tires.

Tire size

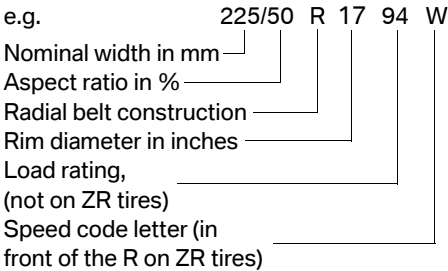

Speed letter

- Q = up to 100 mph/160 km/h
- T = up to 118 mph/190 km/h
- H = up to 131 mph/210 km/h
- V = up to 150 mph/240 km/h
- W = up to 167 mph/270 km/h
- Y = up to 186 mph/300 km/h

Tire Identification Number

Tires with DOT codes meet the guidelines of the U.S. Department of Transportation.

DOT code:

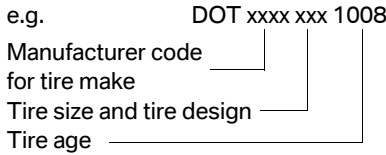

Tire age

The manufacturing date of tires is contained in the tire coding: DOT ... 1008 indicates that the tire was manufactured in week 10 of 2008.

BMW recommends that you replace all tires after 6 years at most, even if some tires may last for 10 years.

Uniform Tire Quality Grading

Quality grades can be found where applicable on the tire sidewall between tread shoulder and maximum section width. For example:

Tread wear 200 Traction AA
Temperature A

DOT Quality Grades

Tread wear
Traction AA A B C
Temperature A B C

 All passenger car tires must conform to Federal Safety Requirements in addition to these grades. ◀

Tread wear

The tread wear grade is a comparative rating based on the wear rate of the tire when tested under controlled conditions on a specified government test course. For example, a tire graded 150 would wear one and one-half (1 ½) times as well on the government course as a tire graded 100. The relative performance of tires depends upon the actual conditions of their use, however, and may depart significantly from the norm due to variations in driving habits, service practices and differences in road characteristics and climate.

Traction

The traction grades, from highest to lowest, are AA, A, B, and C.

These grades represent the tire's ability to stop on wet pavement, as measured under controlled conditions on specified government test surfaces of asphalt and concrete. A tire marked C may have poor traction performance.

 The traction grade assigned to this tire is based on straight-ahead braking traction tests, and does not include acceleration, cornering, hydroplaning, or peak traction characteristics. ◀

Temperature

The temperature grades are A, the highest, B, and C, representing the tire's resistance to the generation of heat and its ability to dissipate heat when tested under controlled conditions on a specified indoor laboratory test wheel.

Sustained high temperature can cause the material of the tire to degenerate and reduce tire life, and excessive temperature can lead to sudden tire failure. The grade C corresponds to a level of performance which all passenger car tires must meet under the Federal Motor Vehicle Safety Standard No. 109. Grades B and A represent higher levels of performance on the laboratory test wheel than the minimum required by law.

 The temperature grade for this tire is established for a tire that is properly inflated and not overloaded. Excessive speed, underinflation, or excessive loading, either separately or in combination, can cause heat buildup and possible tire failure. ◀

RSC – run-flat tires

You will recognize run-flat tires by a circular symbol containing the letters RSC on the side of the tire, refer to page 229.

M+S

Winter and all-season tires.

These have better winter properties than summer tires.

XL

Indicates specially reinforced tires.

Tire condition

Inspect your tires frequently for tread wear, signs of damage and for foreign objects lodged in the tread. Check the tread depth.

Minimum tread depth

The tread depth should not drop below 0.12 in/3 mm, although, for example, European legislation only specifies a minimum tread depth of 0.063 in/1.6 mm. At tread depths below 0.12 in/3 mm there is an increased risk of high-speed hydroplaning, even when only small amounts of water are present on the road surface. When winter tires wear down past a tread depth of 0.16 in/4 mm, they become perceptibly less suitable for winter conditions. For the sake of safety, new tires should be installed.

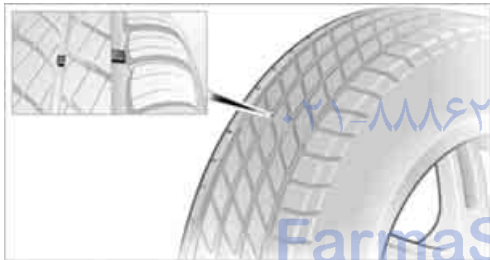

Wear indicators at the tread-groove base, refer to arrow, are distributed over the tire's circumference and are marked on the side of the tire with TWI – Tread Wear Indicator. If the tire tread has been driven down to the wear indicators, a tread depth of 0.063 in/1.6 mm has been reached.

Wheel/tire damage

Please note that low-profile tires cause wheels, tires and suspension parts to be more susceptible to road hazards and consequential damages.

Unusual vibrations encountered during normal vehicle operation can indicate tire failure or some other vehicle defect. This can, for exam-

ple, be caused by driving over curbs. These kinds of problems may also be signaled by other changes in vehicle response, such as a strong tendency to pull to the left or right.

 In these cases, reduce speed immediately and have wheels and tires thoroughly checked. To do so, drive carefully to the nearest BMW center or tire shop that works according to BMW repair procedures with correspondingly trained personnel. If necessary, have the vehicle towed there. Otherwise, tire damage can be extremely dangerous to vehicle occupants and other road users. ◀

Run-flat tires*

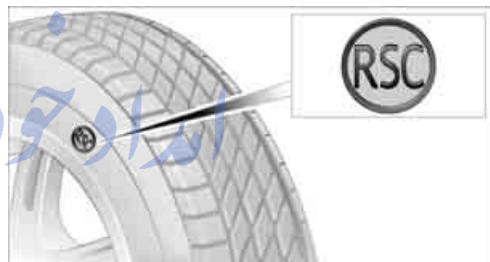

You will recognize run-flat tires by the circular symbol containing the letters RSC on the side of the tire.

Run-flat tires consist of partially self-contained tires and special rims. The sidewall reinforcement ensures that the tire retains some residual safety in the event of pressure drop and driving remains possible to a restricted degree.

To continue driving with a damaged tire:

- ▶ With Flat Tire Monitor, refer to Indication of a flat tire, page 96
- ▶ With Tire Pressure Monitor, refer to Message with low tire inflation pressure, page 98

New wheels and tires

 Have new wheels and tires installed only by your BMW center or tire shop that works according to BMW repair procedures

with correspondingly trained personnel. If this work is not carried out properly, there is a danger of subsequent damage and related safety hazards. Make sure that the new wheels are balanced. ◀

Retreaded tires

 BMW does not recommend that you use retreaded tires, as driving safety may be impaired. The causes for this include the possibly different tire casing structures and the often wide variations in their age, which can result in a limited service life. ◀

The right wheels and tires

 BMW recommends that you use only wheel and tire combinations that BMW has tested and approved for your particular vehicle. Variations in factors such as manufacturing tolerances mean that even wheels and tires with identical official size ratings could actually have different dimensions than the approved units – these differences could lead to body contact, and with it the risk of severe accidents. If non-approved wheels and tires are used, BMW cannot evaluate their suitability, and therefore cannot be held liable for driving safety. ◀

You can inquire about the right wheel/tire combination at your BMW center.

The correct wheel/tire combination also affects various systems whose function would otherwise be impaired, e.g. ABS, DSC or xDrive.

To maintain good handling and vehicle response, use only tires of a single tread configuration from a single manufacturer. Following tire damage, have the original wheel and tire combination remounted on the vehicle as soon as possible.

Wheels with electronics for TPM Tire Pressure Monitor

When mounting new tires or converting from summer to winter tires or vice versa, only use wheels with TPM electronics, otherwise the Tire Pressure Monitor cannot detect a flat tire,

refer to page 97. Your BMW center will be happy to advise you on this subject.

Recommended tire brands

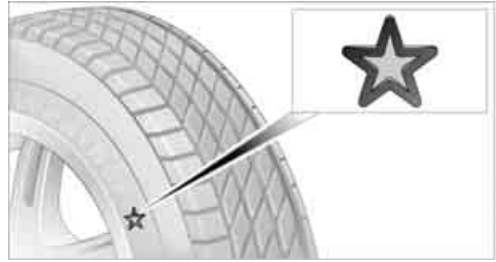

Certain tire makes are recommended by BMW depending on the tire size. You can recognize these from the clearly visible BMW marking on the tire sidewall.

When used properly, these tires comply with the most demanding standards for safety and vehicle response.

Run-flat tires

When mounting new tires, or changing from summer to winter tires or vice versa, use run-flat tires for your own safety. In addition, no spare tire is available in case of a flat tire. Your BMW center will be glad to advise you.

Special characteristics of winter tires

BMW recommends winter tires for use in cold winter driving conditions. Although all-season M+S tires provide better winter traction than summer tires, they generally fail to provide the same levels of cold-weather performance as winter tires.

Paying attention to speed

 Always observe the maximum permissible speed for the winter tires, otherwise tire damage may occur, which can result in accidents. ◀

Storage

Store wheels and tires in a cool, dry place with as little exposure to light as possible. Always protect tires against all contact with oil, grease

and fuels. Do not exceed the maximum tire inflation pressure indicated on the side wall of the tire.

Rotating wheels between axles

BMW does not recommend moving the front wheels to the rear or vice versa, as otherwise the handling characteristics may be impaired. With tires of different makes and types* such a change is not permissible.

Snow chains*

BMW only tests certain fine-link snow chains, classifies them as road-safe and recommends them. Consult your BMW center for more information.

Use is only permissible in pairs on the rear wheels.

Observe the manufacturer's instructions when mounting snow chains. Do not exceed a speed of 30 mph/50 km/h with the chains mounted.

 After mounting snow chains, do not initialize the Flat Tire Monitor, otherwise incorrect displays can occur.

When driving with snow chains, it may be practical to briefly activate DTC, refer to page 92. ◀

FarmaSOS.com

Under the hood

⚠ Never attempt to perform any service or repair operations on your vehicle without the required professional technical training. If you do not know what repair procedures to follow, have work on your vehicle done only by your BMW center or a workshop that works according to BMW repair procedures with correspondingly trained personnel. If this work is not carried out properly, there is a danger of subsequent damage and related safety hazards. ◀

Hood

Releasing

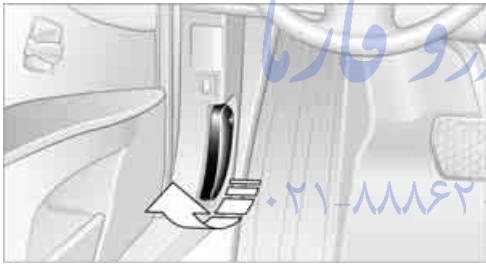

Pull lever.

Opening

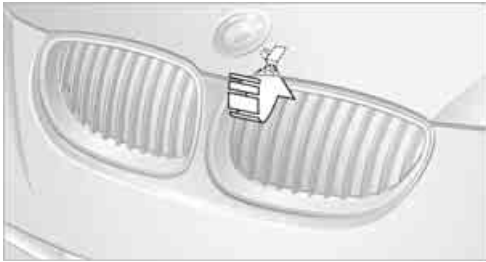

Press the release handle and open the hood. Do not open the hood until the engine has cooled down.

Closing

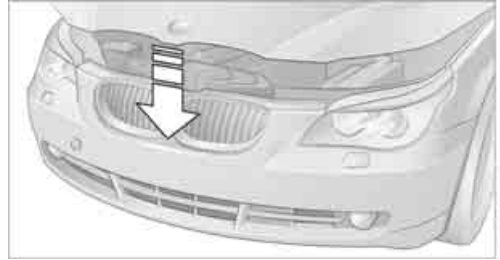

Close the hood from a height of approx. 16 in/ 40 cm with momentum. It must be clearly heard to engage.

⚠ Make sure that the closing path of the hood is clear, otherwise injuries may result.

If you see any signs that the hood is not completely closed while driving your vehicle, you should stop at once and close it securely. ◀

FarmaSOS.com

Engine compartment



- 1 Filler spout for engine oil, refer to Adding engine oil
- 2 Starting-aid terminal, refer to page 254
- 3 Filler neck for washer fluid of the headlamp and windshield cleaning systems, refer to page 70
- 4 Expansion tank for coolant, refer to page 235

FarmaSOS.com

Engine oil

The engine oil consumption is dependent on driving style and driving conditions.

Checking engine oil level

Your vehicle is equipped with an electronic oil level check.

The condition for the most accurate indication of the oil level possible is measurement with the engine at operating temperature, i.e. following an uninterrupted drive of at least 6 miles/10 km. You can display the oil level on the Control Display while driving or when stopped on a level surface with the engine running.

iDrive, for operating principle refer to page 16.

1. Press the **MENU** button.
This opens the start menu.
2. Press the controller to open the **i** menu.
3. Turn the controller until "Info sources" is selected and press the controller.



4. Turn the controller until "Service Info" is selected and press the controller.
5. Change to upper field if necessary. Turn the controller until "Service requirements" is selected and press the controller.



6. Change to the second field from the top if necessary. Turn the controller until "Engine oil level" is selected and press the controller. The oil level is displayed.

Possible messages

- ▷ "Engine oil level O.K."
- ▷ "No measurement available: Updating engine oil level measurement...":
The engine oil level is measured. This process can take approx. 1 minute when stopped on a level surface with the engine running and approx. 5 minutes while driving.
If the engine oil has been topped off, the measurement of the oil level can take up to 30 minutes.
- ▷ "Oil level at the minimum! Refill with 1 quart of engine oil.":
Add a maximum of 1 US quart/liter of engine oil at the next opportunity, refer also to Adding engine oil below. Add at least 0.5 US quart/liter of oil; otherwise, the oil level check cannot reliably display the new oil level.
If the oil level displayed is below minimum, add engine oil immediately. Failure to do so may lead to engine damage.
- ▷ "Engine oil level too high"*:
 Have the vehicle checked immediately, otherwise engine damage may result if too much oil has been added. ◀
- ▷ "Please observe recalculated service interval for engine oil":
Do not add engine oil. Before continuing to drive, note the recalculated remaining mileage until the next oil change service, refer to Service requirements on page 82. Have the system checked as soon as possible.

Adding engine oil

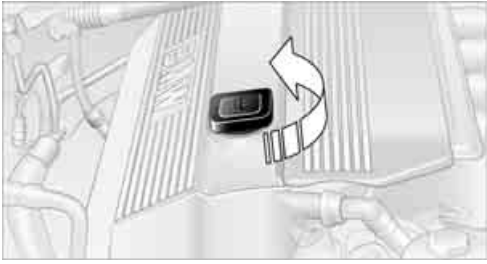

Do not add 1 US quart/liter of oil until a corresponding message is shown on the Control Display.

 Add oil within the next 125 miles/200 km, otherwise the engine could be damaged. ◀

 Continuous exposure to used oil has caused cancer in laboratory testing. For this reason, any skin areas that come into contact with oil should be thoroughly washed with soap and water. Keep oil, grease etc. out of reach of children and observe the warnings on the containers to prevent health risks. ◀

Oil change

Have oil changed only at your BMW center or at a workshop that works according to BMW repair procedures with correspondingly trained personnel.

Approved engine oils

The quality of the engine oil selected has critical significance for the operation and service life of an engine. BMW continuously approves specific oils after confirming their suitability for use in its vehicles with extensive testing.

 Do not use oil additives, as these may result in engine damage. ◀

Only use approved BMW High Performance Synthetic Oil.

If BMW High Performance Synthetic Oil is unavailable, you can add small quantities of other synthetic oils between oil changes. Only use oils of the specification API SM or higher.

 Your BMW center will be happy to answer detailed questions on BMW High Performance Synthetic Oil or approved synthetic oils. ◀

You can also call BMW of North America at 1-800-831-1117 or visit the website at www.bmwusa.com to obtain this information.

Viscosity grades

Viscosity is a measure of an oil's flow rating and is specified in SAE grades.

The choice of the right SAE grade is based on the climatic conditions in the region in which you normally drive your BMW.

 Approved oils belong to the 0W-40, 0W-30, 5W-40 and 5W-30 SAE grades. ◀

These oils can be used for driving at all outside temperatures.

BMW recommends 

Coolant

 Do not add coolant to the cooling system when the engine is hot. Escaping coolant can cause burns. ◀

Coolant is composed of equal parts water and a coolant additive. Not all commercially available additives are suitable for your BMW. Ask your BMW center for suitable additives.

 Only use suitable additives, otherwise engine damage may result. The additives present a health hazard; observe the instructions on the containers. ◀

 Comply with the appropriate environmental protection regulations when disposing of coolant additives. ◀

Checking coolant level

1. Do not open the hood until the engine has cooled down.
2. Turn the cap of the expansion tank counterclockwise to allow any accumulated pressure to escape, then continue turning to open.

- The coolant level is correct when the coolant level is between the MIN and MAX marks, refer to the diagram adjacent to the filler neck.



- If the coolant is low, slowly add coolant up to the specified level – do not overfill.
- Turn the cap until there is an audible click.
- Have the reason for the coolant loss eliminated as soon as possible.

امداد خودرو فارما

تلفن شبانه روزی: ۰۲۱-۸۸۸۶۲۰۸۵

FarmaSOS.com

BMW maintenance system

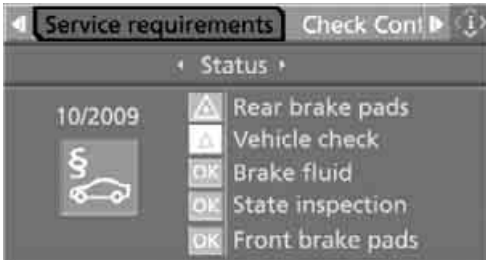

The BMW maintenance system supports the preservation of the traffic and operating safety of your BMW. The ultimate objective is to ensure economical maintenance by providing the ideal service for your vehicle.

Should the day come when you decide to sell your BMW, a complete dealer service history will prove to be an asset of inestimable value.

CBS Condition Based Service

Sensors and special algorithms take the different driving conditions of your BMW into account. Condition Based Service uses this to determine the current and future service requirements. By letting you define a service and maintenance regimen that reflects your own individual requirements, the system builds the basis for trouble-free driving.

You can set the Control Display to show remaining distances and times of selected maintenance intervals and legally mandated deadlines, refer to page 82:

- ▷ Engine oil
- ▷ Brake pads, separate for the front and rear
- ▷ Brake fluid
- ▷ Vehicle check
- ▷ Legally mandated inspections depending on local regulations

Service data in remote control

Your vehicle stores the information required maintenance continuously in the remote control during driving. After accessing the data stored in the remote control, your BMW Service Advisor can suggest precisely the right array of service procedures for your own individual vehicle. You should therefore hand over the remote control you last used to drive to the BMW Service Advisor when you take your vehicle in for service.

 Make sure the date is set correctly, refer to page 88, otherwise the effectiveness of CBS Condition Based Service is not ensured. ◀

Service and Warranty Information Booklet for US models and Warranty and Service Guide Booklet for Canadian models

Please consult your Service and Warranty Information Booklet for US models and Warranty and Service Guide Booklet for Canadian models for additional information on service requirements.

 BMW recommends that you have service and repair operations performed at your BMW center.

Take the time to ensure that these service procedures are confirmed by entries in your vehicle's Service and Warranty Information Booklet for US models and Warranty and Service Guide Booklet for Canadian models. These entries verify that your vehicle has received the specified regular maintenance. ◀

Socket for OBD Onboard Diagnostics interface

be transmitted or recorded to enable corresponding services.

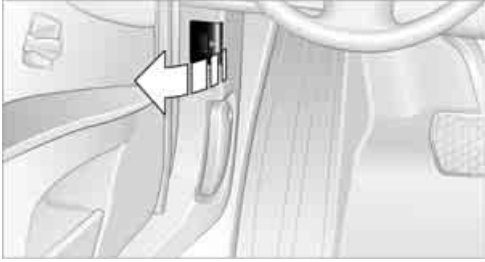

Components which are decisive for the exhaust-gas composition can be checked via the OBD socket with a device.

This socket is located to the left on the driver's side, on the underside of the instrument panel under a cover.

Exhaust-gas values



The warning lamp lights up. The exhaust-gas values worsen. Have the vehicle checked as soon as possible.



Display of the previously described malfunction in Canadian models.

The lamp flashes under certain conditions. This is a sign of excessive misfiring of the engine. In this case you should reduce speed and drive to the nearest BMW center as soon as possible. Heavy engine misfiring causes serious damage to the emission-relevant components, especially the catalytic converter, within a short time.



If the fuel filler cap is not properly tightened, the OBD system will assume that fuel vapor escapes. Then a display lights up. If the cap is then tightened, the display will go out within a few days. ◀

Event Data Recorders

Your vehicle may be equipped with one or several measuring and diagnosis modules, or with a device for recording or transmitting certain vehicle data or information. If you have also subscribed to BMW Assist, certain vehicle data can

Car-care products

Regular cleaning and care make a significant contribution to retaining your BMW's value.

For the cleaning and care of your vehicle, BMW recommends using only products that BMW has approved for this purpose.

Your BMW center will be glad to advise you about products and services for the cleaning and care of your BMW.

 Genuine BMW Care Products are materials tested, laboratory tested, and tested in actual use. They offer optimum care and protection for your vehicle. ◀

 Do not use cleaners that contain alcohol or solvents; they can damage your vehicle. ◀

 Cleaning agents can contain substances that are dangerous or pose health risks. You should therefore heed the warnings and hazard indications on the packaging. Open the doors or windows on your vehicle whenever cleaning the interior. Make sure there is sufficient ventilation in enclosed spaces. Use only products that are formulated for vehicle cleaning. ◀

Exterior care

Washing your vehicle

 In the winter months, it is especially important to ensure that the vehicle is washed on a regular basis. Otherwise, significant soiling and road salt can cause damage to the vehicle. ◀

 After washing the vehicle, apply the brakes briefly to dry them. Failure to do so may lead to a reduction in braking efficiency and also to corrosion of the brake rotors. ◀

Car washes

Give preference to cloth car washes.

Before driving into the car wash, make sure that it is suitable for your BMW. Pay attention to the following points:

- ▷ Dimensions of your vehicle, refer to page 261.
- ▷ If necessary, fold in the outside rearview mirrors, refer to page 55.
- ▷ Maximum permissible tire width.

Preparations for driving into the car wash:

- ▷ Deactivate rain sensor to prevent unwanted wiper activation.
- ▷ Deactivate rear window wiper* and protect it from damage. Take appropriate protective measures; inquiring with the car wash operator as needed.
- ▷ Remove additional add-on parts, e.g. spoilers or phone antennas, if they could be damaged.

Automatic transmission

Before driving into the car wash, make sure the vehicle is able to roll by making sure to:

1. Insert the remote control into the ignition lock, even with comfort access.
2. Shift into transmission position N.
3. Release the parking brake.
4. Switch off the engine.
5. Leave the remote control in the ignition lock so that the vehicle can roll.

Steam cleaners/high-pressure cleaning jets

 When using steam jets or high-pressure washers, ensure that you maintain sufficient clearance to the vehicle and do not exceed a temperature of 140°F/60°C.

Insufficient distance or excessive pressure or temperature can damage parts of the vehicle or can result in water penetration. Follow the operating instructions for the high-pressure cleaning jets. ◀

 When using high-pressure cleaning jets, do not remain in one place for a long time and be sure to maintain a distance of at least 12 in/30 cm from sensors, e.g. Park Distance Control sensors or radar sensors. ◀

Hand washing

When washing the vehicle by hand, use plenty of water and car washing shampoo. Clean the vehicle with gentle pressure using a sponge or a washing brush.

 Before cleaning the windshield, deactivate the rain sensor or switch off the ignition to prevent unwanted wiper operation. ◀

 Follow local guidelines for washing vehicles by hand. ◀

Headlamps

Do not rub dry and never use abrasives or strong solvents to clean the covers.

Loosen dirt, e.g. insects, with shampoo or insect remover and wash away with plenty of water.

Use a window de-icer to remove accumulated ice and snow, not a scraper.

Windows

Use a glass cleaner to clean the inside and outside surfaces of the windows and the glass surfaces of the mirrors.

 Do not use quartz-containing cleansers to clean glass surfaces of the mirrors. ◀

Wiper blades

Clean with soapy water and replace regularly to prevent streaking.

 The presence of wax and sealant residues and dirt on the windows leads to streaking during wiper operation and results in premature wear on wiper blades as well as interference with the rain sensor. ◀

Caring for the vehicle finish

Regular care helps your vehicle retain its value and protects the paint from the long-term effects of aggressive substances.

Regionally occurring environmental factors can affect and damage vehicle finish. It is therefore important to tailor the frequency and extent of your car care accordingly.

Immediately remove particularly aggressive substances such as spilled fuel, oil, grease, brake fluid, tree resin, or bird droppings; otherwise, they may damage your paint.

Repairing paint damage

 Repair stone damage or scratches immediately, depending on the severity of the damage, to prevent the formation of rust. ◀

BMW recommends having paint damage professionally repaired using Genuine BMW finish materials in accordance with factory guidelines.

Waxing

Sealant is required when water no longer beads on the clean surface of the paint. Use only products that contain carnauba wax or synthetic wax to seal your finish.

Rubber gaskets

Treat only with water or a rubber care product.

 To avoid noise or damage, do not use products that contain silicone to care for rubber gaskets. ◀

Chrome components

Particularly after exposure to road salt, thoroughly cleanse parts like the radiator grille, door handles, or window frames with plenty of water with shampoo added to it. For additional treatment, use chrome polish.

Alloy wheels

Depending on your system, braking can generate dust, which settles on the light-alloy wheels. Remove this dust regularly with acid-free wheel cleaner.

 Do not use aggressive, acid-containing, strongly alkaline, or coarse cleansers and do not use steam cleaners at temperatures greater than 140 °F /60 °C; otherwise you may damage your vehicle. ◀

Outside sensors

Sensors on the outside of the vehicle, such as Park Distance Control sensors or radar sensors, should be kept clean and free of ice to retain their full function.

Interior care

Upholstery materials/cloth-covered paneling

Clean regularly with a vacuum cleaner in order to remove surface dirt.

In the event of more serious soiling such as beverage stains, use a soft sponge or a lint-free microfiber cloth in combination with suitable interior cleaners. Follow the instructions on the packaging.

 Clean upholstery material over a large area extending out to the seams. Avoid intense friction. ◀

 Open Velcro fasteners on pants or other items of clothing can cause damage to the seat covering. Make sure that the Velcro fasteners are closed. ◀

Leather/leather-covered paneling

 The leather used by BMW is a high quality natural product. Slight patterns in the grain are part of the typical properties of a natural leather.

Dust and dirt from the road chafe in pores and folds and result in considerable wear and cause the leather surface to become prematurely brittle. We therefore suggest that you clean the leather with a dust cloth or vacuum cleaner at regular intervals. ◀

Particularly with light-colored leather, make sure to clean it regularly since it has a greater tendency to become soiled.

Treat the leather twice a year with a leather lotion since dirt and grease harm the protective layer of the leather.

Carpets/luggage compartment

Carpeting, floor mats, and luggage compartment rugs and paneling can be cleaned with a vacuum or in the event of more serious soiling, cleansed with an interior cleaner.

Floor mats and luggage compartment rugs can be removed for cleaning. When inserting into place, make sure that the seat rails do not protrude over the floor mats; otherwise floor mats can be damaged.

Fluff on new floor mats is a result of the production process and can be removed by repeated vacuuming.

Plastic components inside

Clean the glass cover of the instrument panel, imitation leather surfaces, lamp lenses, and matte components with water and, if necessary, a solvent-free plastic cleaner.

Fine wooden components

Use a damp cloth to clean fine wooden trim panels and components. Follow up by drying with a soft cloth.

Safety belts

 Do not use cleansers to clean the safety belts since this can destroy the webbing. ◀

Inside sensors

Clean inside sensors such as those of the high-beam assistant using a lint-free cloth moistened with glass cleaner.

Displays

Clean displays like the radio or the Control Display using a display-cleaning cloth or a soft, nonabrasive lint-free cloth.

 Avoid using excessive pressure when cleaning displays; otherwise, you could damage them. ◀

 Never use chemical-based cleansers or household scouring products. Keep all liquids away from the equipment. Otherwise

corrosion or damage to surfaces or electrical components can occur. ◀

CD/DVD-player



Do not use cleaning CDs; they can damage parts of the player. ◀

Storing your vehicle

When storing your vehicle for longer than three months, please seek the advice of your BMW center or a workshop that works in accordance with BMW guidelines.

امداد خودرو فارما

تلفن شبانه روزی: ۰۲۱-۸۸۸۶۲۰۸۵

FarmaSOS.com

Replacing components

Onboard toolkit

Sedan



The onboard toolkit is located in the luggage compartment lid.

Loosen the wing nut to open.

Sports Wagon

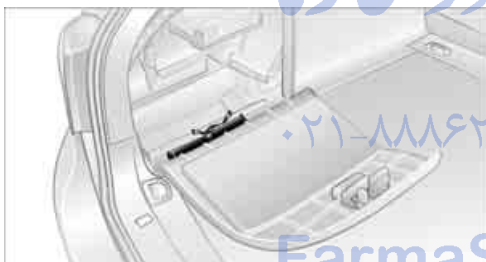

The onboard toolkit is located in the left side panel of the cargo bay.

Wiper blade replacement

Front



1. Fold the wiper arm out and grasp firmly.
2. Press the safety tabs together while sliding the wiper blade toward the front to disengage it.
3. Mount the new wiper blade and slide in until it is heard to engage.

Rear*



1. Lift off the wiper arm completely and pull off the wiper blade, refer to arrow.
2. Mount the new wiper blade and press on until it is heard to engage.

Lamps and bulbs

Lamps and bulbs make an essential contribution to vehicle safety. You must be duly diligent in replacing them. BMW recommends having your BMW center perform any work that you do not feel competent to perform yourself or that is not described here.

▶ Never touch the glass of new bulbs with your bare fingers, as even minute amounts of contamination will burn into the bulb's surface and reduce its service life. Use a clean cloth, napkin, etc., or hold the bulb by its metal socket. ◀

A selection of replacement bulbs is available at your BMW center.

⚠ Only replace bulbs when cool, as otherwise you may be burned. ◀

⚠ Whenever you perform any work on the electrical system, turn off the systems/consumers involved to prevent short circuits from occurring. To avoid possible injury or equipment damage when replacing bulbs, observe any instructions provided by the bulb manufacturer. ◀

For information on how to care for the headlamps, please follow the instructions on page 239.

▶ For bulbs for which changing is not described, and for checking and adjusting headlamp aim, please contact your BMW center. ◀

Light-emitting diodes LEDs

Light-emitting diodes installed behind translucent lenses serve as the light source for many of the controls and displays in your vehicle. These light-emitting diodes, which operate using a concept similar to that applied in conventional lasers, are officially designated as Class 1 light-emitting diodes.

⚠ Do not remove the covers, and never stare into the unfiltered light for several hours, as irritation of the retina could result. ◀

Halogen headlamps

The illustration shows the left-hand side of the engine compartment.

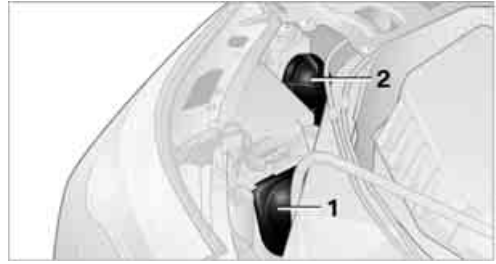

- 1 Cover cap for low beams
- 2 Cover cap for high beams

To remove the cover caps:

- ▶ Low beams: press the detent, arrow, and remove the cover from the guide.



- ▶ High beams: turn the cover cap to the left and remove.

⚠ Always wear gloves and eye protection – the atmosphere within the H7 bulb is pressurized. Otherwise there is a danger of injuries if the bulb is accidentally damaged during replacement. ◀

Low beams

H7 bulb, 55 watts

1. Turn the bulb holder to the left and remove.



2. Remove and replace the bulb.

High beams

H7 bulb, 55 watts

1. Turn the bulb holder to the left and remove.



2. Remove and replace the bulb.

Parking and roadside parking lamps

In the event of a malfunction, please go to your BMW center or a workshop that works according to BMW repair procedures with correspondingly trained personnel.

Xenon lamps*

The service life of these bulbs is very long and the probability of a failure is very low, provided that they are not switched on and off an unusual number of times. If one of these bulbs should nevertheless fail, it is possible to continue driving with great caution using the fog lamps, provided traffic laws in your area do not prohibit this.

 Have work on the xenon lighting system performed only by your BMW center or a

workshop that works according to BMW repair procedures with correspondingly trained personnel. Due to the high voltage present in the system, there is a danger of fatal injuries when work is carried out improperly. ◀

Access to lamps

The illustration shows the left-hand side of the engine compartment.

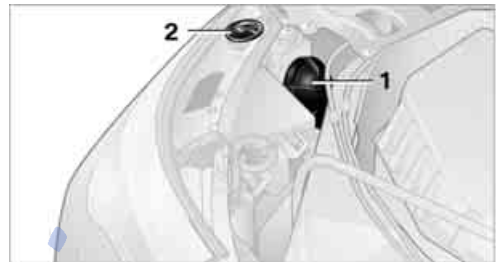

- 1 Cover cap for parking and roadside parking lamps, daytime running lamps
- 2 Sealing cap for turning lamps*

To remove the covers:

- ▷ Parking lamps and roadside parking lamps, daytime running lamps: turn the cover cap to the left and remove.
- ▷ Turning lamps: turn the sealing cap to the left and remove.

Parking lamps and roadside parking lamps, daytime running lamps

H8 bulb, 35 watts

1. Turn the bulb in the direction of the arrow, in the opposite direction on the other side, and remove.



2. Remove the connector and replace the bulb.

Turning lamps*

H3 bulb, 55 watts

1. Remove the sealing cap, refer to Access to lamps.
2. Push the locking bar to the side out of the anchor and fold upward.



3. Remove the connector and take out the bulb.
4. Replace the bulb and reinstall.
5. Fold down the locking bar and engage it.
6. Reconnect the connector.
7. Mount the sealing cap. Watch the markings on the bulb when doing so.

Turn signals, front

21-watt bulb, PY21W

1. Turn the bulb holder to the left and remove.



2. Apply gentle pressure to the bulb while turning it to the left for removal and replacement.

Side-mounted turn signals

5-watt bulb, W5W

1. Press back against the front edge of the lamp with the tip of your finger, then pivot it out.

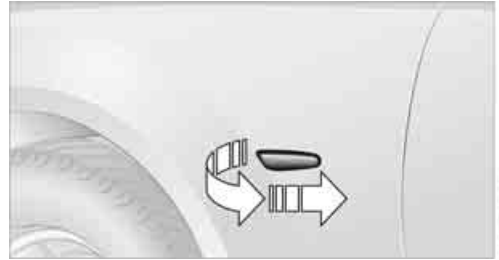

2. Turn the bulb holder to the left and remove.
3. Remove the bulb for replacement.

Side marker lamps, front and rear

To replace, please go to your BMW center or a workshop that works according to BMW repair procedures with correspondingly trained personnel.

Tail lamps

تلفن شبانه روزی: ۰۲۱-۸۸۶۲۰۸۵
Sedan

- ▷ Turn signals **1**, tail lamps **6** and side marker lamps **7** are designed using LED technology. In the event of a malfunction, please go to your BMW center or a workshop that works according to BMW repair procedures with correspondingly trained personnel.
- ▷ Backup lamps: 16-watt bulb, W16W
- ▷ Other lamps: 21-watt bulb, P21W

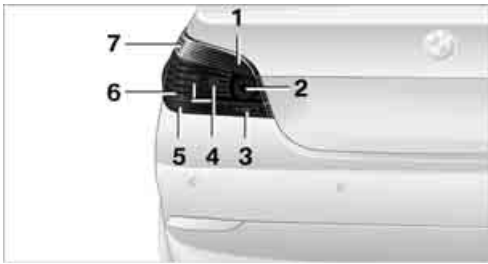

- 1 Turn signal
- 2 Tail lamp and brake lamp
- 3 Backup lamp
- 4 Brake lamp
- 5 Reflector
- 6 Tail lamp
- 7 Side marker lamp

Sports Wagon

- ▷ Turn signals **1**, tail lamps **3** and side marker lamps **7** are designed using LED technology. In the event of a malfunction, please go to your BMW center or a workshop that works according to BMW repair procedures with correspondingly trained personnel.
- ▷ Backup lamps: 16-watt bulb, W16W
- ▷ Brake lamps: 21-watt bulb, P21W

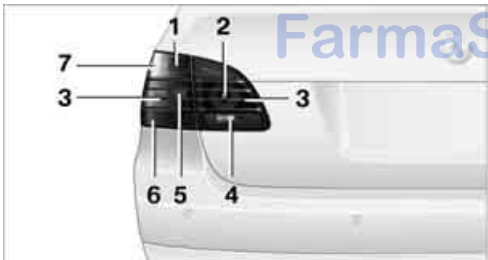

- 1 Turn signal
- 2 Brake lamp
- 3 Tail lamp
- 4 Backup lamp
- 5 Brake lamp
- 6 Reflector
- 7 Side marker lamp

Center brake lamp

This lamp uses LED technology for operation. In the event of a malfunction, please go to your BMW center or a workshop that works according to BMW repair procedures with correspondingly trained personnel.

Fender-mounted lamps

Sedan

The illustration shows the left-hand side of the cargo bay.

All the bulbs are integrated into a central bulb fitting.

1. Lift up floor mat.
2. Undo the quick-release fasteners of the side panel and pull out the panel.
3. Turn the lock to the left and remove the bulb holder.

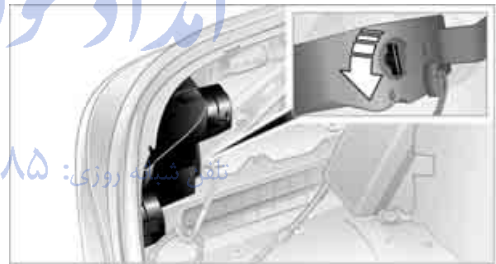

4. Backup lamps: Remove and replace the bulb.
Other lamps: Apply gentle pressure to the bulb while turning it to the left for removal and replacement.

Sports Wagon

1. Right side: Unhook the retaining strap*, refer to page 129.
2. Open the side panel.
3. Turn the bulb socket to the left and remove.
4. Apply gentle pressure to the bulb while turning it to the left for removal and replacement.

Lamps in luggage compartment lid

License plate lamp

5-watt bulb, C5W

1. Insert screwdriver into the slot and press to the right, refer to arrows. This releases the lamp.

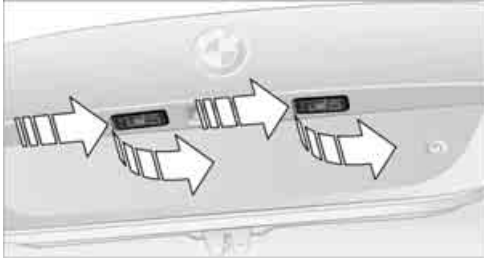

2. Remove the lamp and replace the bulb.

Sports Wagon: Brake lamp and backup lamp

1. Turn the locks to the left and fold down the trim.



2. Fold down the foam insulation.

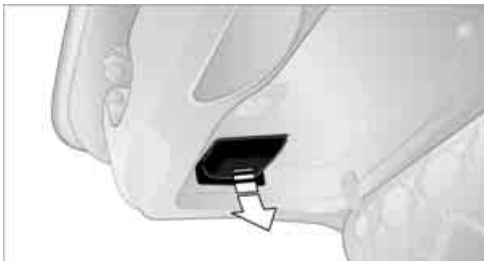

3. Pull out the bulb holder for the backup lamp 1 or brake lamp 2 downward.

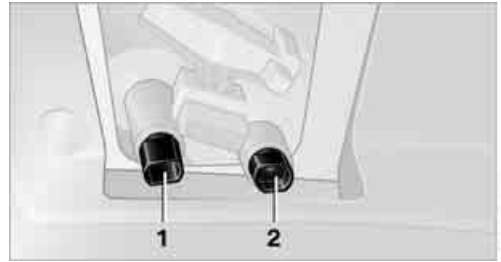

4. Backup lamp: remove the bulb for replacement.
Brake lamp: apply gentle pressure to the bulb while turning it to the left for removal and replacement.

Changing wheels

⚠ Safety precautions in the event of a flat tire or wheel change: Park the vehicle as far as possible from passing traffic and on solid ground. Switch on the hazard warning flashers. Have all vehicle occupants get out of the vehicle and ensure that they remain outside the immediate area in a safe place, such as behind a guardrail.

If a warning triangle* or portable hazard warning lamp* is required, set it up on the roadside at an appropriate distance from the rear of the vehicle. Comply with all safety guidelines and regulations.

Change the wheel only on a level, firm surface which is not slippery. The vehicle or the jack could slip to the side if you attempt to raise the vehicle on a soft or slippery surface such as snow, ice, tiles, etc.

Position the jack on a firm support surface. Do not use a wooden block or similar object as a support base for the jack, as this would prevent it from extending to its full support height and reduce its load-carrying capacity.

To avoid serious or fatal injury: never lie under the vehicle, and never start the engine while it is supported by the jack. ◀

What you will need

To avoid rattling noises later on, note the positions of the tools before removing them, then return them to their initial positions after completing work.



- 1 Chock*
- 2 Vehicle jack*
- 3 Lug wrench*

The tools are located in the mount under the floor mat or floor panel flap.

1. Lift up floor mat or floor panel flap and cover located beneath it.
2. Take out the required tools.
3. After using the tools, return them to the storage space.

 With run-flat tires, no tools are provided for wheel changes. They can be purchased as accessories at your BMW center. ◀

Sports Wagon: removing and installing floor panel flap of storage area package

1. Unhook the roll-up cover at the rear.
2. Raise the floor panel flap.
3. Unhook the two catch straps at the top.

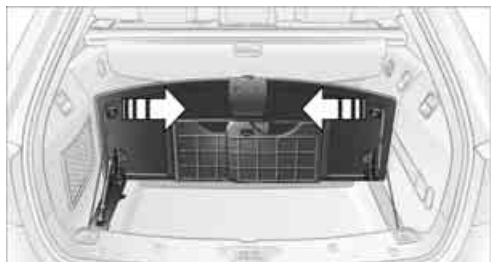

4. Unlock the gas spring strut, refer to arrow, and remove.

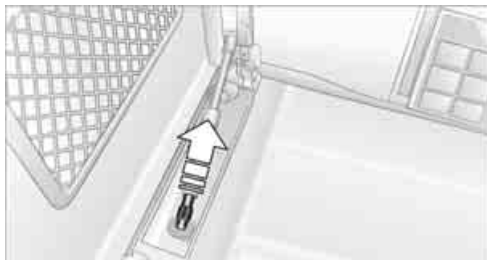

5. Fold over the floor panel flap toward the front to release it and remove.

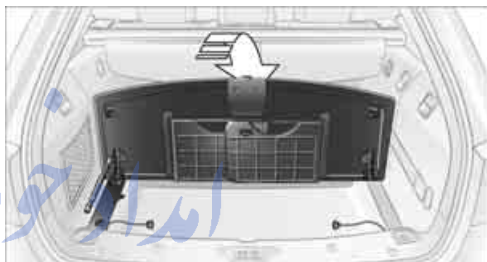

6. Open the front floor panel flap.
7. Swing up the spare tire cover and hook the hooks into the upper frame of the tailgate opening.
8. Take out the cross support upward.



When installing the floor panel flap, proceed in the reverse order and press down the hinge covers.

Compact wheel*

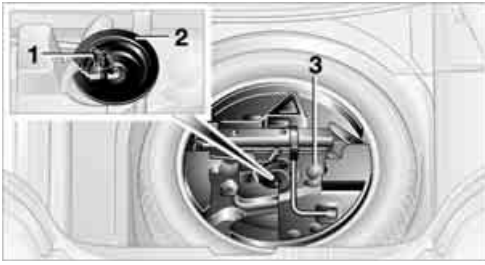

1. Unscrew the wing nut **1**.
2. Remove the washer **2** laterally.
3. Take out the tool mounts **3**.
4. Remove the compact wheel.

Preparing wheel change

1. Observe the safety precautions above.
2. Prevent the vehicle from rolling: Place the chock behind the front wheel on the other side of the vehicle, or on inclines, in front of this wheel. On steeply inclined roads, always secure the vehicle against rolling.
3. Loosen the lug bolts a half turn.

Jacking up vehicle

1. Position the vehicle jack at the jacking point closest to the wheel so that the entire surface of the jack base rests on the ground perpendicularly beneath the jacking point.



The vehicle jack is designed for changing wheels only. Do not attempt to raise another vehicle model with it or to raise any load of any kind. To do so could cause accidents and personal injury. ◀

2. Guide the jack head into the rectangular recess of the jacking point when cranking up, refer to illustration detail.



3. Jack the vehicle up until the wheel you are changing is raised from the ground.

Mounting a wheel

1. Unscrew the lug bolts and remove the wheel.
2. Remove accumulations of mud or dirt from the mounting surfaces of the wheel and hub. Also clean the lug bolts.
3. Position the new wheel or compact wheel. Secure the wheel by screwing at least two lug bolts into opposite bolt holes. When you mount wheels other than Genuine BMW light-alloy wheels, different lug bolts may also be required.
4. Screw in the remaining lug bolts. Tighten all the bolts securely in a diagonal pattern.
5. Lower the vehicle and remove the jack from beneath the vehicle.

After mounting

1. Tighten the lug bolts in a diagonal pattern.



To ensure safety, always have the lug bolts checked with a calibrated torque wrench as soon as possible to ensure that they are tightened to the specified torque. Otherwise, incorrectly tightened lug bolts are a hidden safety risk. The tightening torque is 88.5 lb ft/120 Nm. ◀

2. When stowing the wheel and tools in the vehicle, execute these steps in the reverse order.

3. Check and correct the tire inflation pressure at the earliest opportunity.



Protect valve stems with valve stem seal caps against dirt and contamination. Dirt in valve stems is a frequent source of gradual air loss. ◀

4. Initialize the Flat Tire Monitor, refer to page 95, or reset the Tire Pressure Monitor, refer to page 97.
5. Replace the damaged tire as soon as possible and have the new wheel/tire balanced.

Driving with compact wheel

Drive reservedly and do not exceed a speed of 50 mph/80 km/h.

The driving characteristics change, for example reduced track stability on braking, extended braking distance, and altered self-steering characteristics in the limit range. In conjunction with winter tires, these characteristics are more pronounced.



Only one compact wheel may be mounted. Restore the wheels and tires to their original size as quickly as possible. Failure to do so is a safety risk. ◀

Vehicle battery

Battery care

The battery is 100% maintenance-free, i.e., the electrolyte will last for the life of the battery when the vehicle is operated in a temperate climate. Your BMW center will be glad to advise in all matters concerning the battery.

Charging battery

Only charge the battery in the vehicle via the terminals in the engine compartment with the engine switched off. Connections, refer to Jump starting on page 254.

Disposal



Have old batteries disposed of by your BMW center or hand them in to a recycling center. Maintain the battery in an upright

position for transport and storage. Always restrain the battery to prevent it from tipping over during transport. ◀

Power failure

Following a temporary power failure, e.g. due to a discharged battery, the use of some equipment will be restricted, requiring its reinitialization. In the same way, individual settings are lost and must be updated again:

- ▷ Seat, mirror and steering wheel memory
The positions must be stored again, refer to page 50.
 - ▷ Time and date
Must be updated again, refer to page 87.
 - ▷ Radio
Radio stations must be stored again, refer to page 174.
 - ▷ Navigation system
You must wait until the system becomes functional again, refer to page 142.
 - ▷ Glass roof, electric
It may only be possible to raise the glass roof. The system must be initialized, refer to page 44.
 - ▷ Panorama glass roof
It may only be possible to raise the glass roof. The system must be reinitialized, refer to page 46.
 - ▷ Active steering
The system is deactivated and must be reinitialized, refer to page 99. Until then, larger steering wheel movements are required.
 - ▷ Power windows
The pinch prevention system for the power windows must be reinitialized, refer to page 42.
- ▷ Talk to your BMW center before placing the stored vehicle back in service. ◀

Fuses



Never attempt to repair a blown fuse and do not replace a defective fuse with a sub-

stitute of another color or amperage rating, as this could lead to a circuit overload, ultimately resulting in a fire in the vehicle. ◀

Sedan

Spare fuses, plastic tweezers and fuse allocation diagram are located in the compartment for the onboard tool kit, refer to page 243.

Sports Wagon

Spare fuses and a pair of plastic tweezers are contained in the onboard tool kit, refer to page 243. A fuse allocation diagram is located in the cargo bay behind the right-hand side panel.

In glove compartment

1. Release both quick-release fasteners.



2. Fold the cover forward or remove.

Sedan: in cargo bay

1. Lift up floor mat.
2. Release the quick-release fastener of the right side panel and pull out the panel.

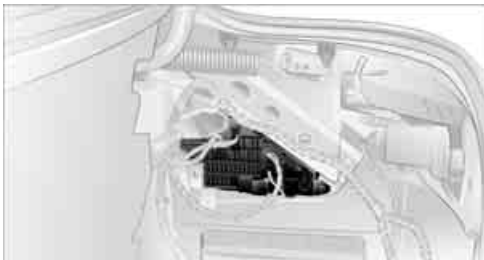

Sports Wagon: in cargo bay



1. Unhook the retaining strap*, refer to page 129.
2. Open the right-hand side panel.

امداد خودرو فارما

تلفن شبانه روزی: +۹۸-۸۸۷۷۲۰۸۵

FarmaSOS.com

Giving and receiving assistance

Emergency request

Conditions for an emergency request:

- ▶ Full preparation package mobile phone.
With this equipment, an emergency request is still possible when no mobile phone is paired with the vehicle.
- ▶ BMW Assist is activated.
Activating BMW Assist, refer to page 215.
- ▶ Radio readiness is activated.
- ▶ The BMW Assist system is logged on to a mobile phone network.
- ▶ The emergency request system is operable.

Once your BMW Assist subscription expires, the BMW Assist system can be deactivated by a BMW center without you having to visit a workshop. Once the BMW Assist system has been deactivated, emergency requests are not possible. The BMW Assist system can be reactivated by a BMW center after signing a new contract.

Initiating an emergency request

1. Briefly press protective cover to open.
Depending on the vehicle's equipment, the arrangement of the switches and indicator lamps may differ somewhat.



2. Press the SOS button for at least 2 seconds.

The LED in the button lights up. As soon as the voice connection to the BMW Assist Response Center has been established, the LED flashes.

Even if you are unable to answer, the BMW Assist Response Center can take further steps to help you under certain conditions.

If conditions allow, remain in the vehicle until the connection has been established. You will then be able to provide a detailed description of the situation.

If the current position of your vehicle can be determined, it will be transmitted to the BMW Assist Response Center.

If the LED is flashing but the BMW Assist Response Center cannot be heard over the hands-free system, it is possible that the hands-free system is malfunctioning. The BMW Assist Response Center may still be able to hear you, though.

Under certain conditions, an emergency request is automatically initiated immediately after a severe accident. Pressing the button does not interfere with this.

For technical reasons, the emergency request cannot be guaranteed under unfavorable conditions.

 You can also use other services of BMW Assist with this button, refer to page 209. ◀

Warning triangle*

The warning triangle is located in the luggage compartment lid/tailgate.

Sedan



Loosen the wing nut to open.

Sports Wagon



Release the two quick-release fasteners and fold down the trim piece.

First-aid kit*

Some of the articles contained in the first-aid kit have a limited service life. Therefore, check the expiration dates of the contents regularly and replace the contents concerned in good time if necessary.

Sedan



The first-aid kit is located in the luggage compartment lid.

Loosen the wing nut to open.

Sports Wagon



The first-aid kit is located in the right side panel of the cargo bay. Before opening the side panel, pull the retaining strap* toward the rear by its rear end and unhook it.

Roadside Assistance*

The Roadside Assistance of the BMW Group offers you assistance in the event of a breakdown around the clock, including on weekends and public holidays.

The phone numbers of the Roadside Assistance in your home country can be found in the Contact brochure.

With BMW Assist you can contact the Roadside Assistance of the BMW Group for assistance in the event of a breakdown directly via iDrive, refer to page 210.

Jump starting

When your battery is discharged, you can use two jumper cables to start your BMW with power from the battery in a second vehicle. You can also use the same method to help start another vehicle. Use only jumper cables with fully-insulated clamp handles.

 To avoid the risk of potentially fatal injury, always avoid all contact with electrical components while the engine is running. Carefully adhere to the following sequence, both to prevent damage to one or both vehicles, and to guard against possible personal injuries. ◀

Preparation

1. Check whether the battery of the other vehicle has a voltage of 12 Volts and approximately the same capacitance in Ah. This information can be found on the battery.
2. Switch off the engine of the assisting vehicle.
3. Switch off any electrical systems and components in both vehicles.

 There must not be any contact between the bodies of the two vehicles, otherwise there is a danger of shorting. ◀

Connecting jumper cables

 To avoid personal injury from sparks, follow this sequence when connecting jumper cables. ◀

In your BMW, the so-called jump-starting terminal in the engine compartment serves as a positive terminal for the battery, also refer to engine compartment overview on page 233. The cover cap is marked with a +.

1. Fold open the cover of the BMW jump-starting terminal. To do so, pull the tab.



2. Attach one end of the jumper cable plus/+ to the positive terminal of the battery or a jump-starting terminal of the vehicle providing assistance.
3. Attach the second end of the cable to the positive terminal of the battery or to a starting-aid terminal of the vehicle to be started.
4. Attach one end of the jumper cable minus/- to the negative terminal of the battery or to an engine or body ground of the assisting vehicle.

Your BMW has a special nut as body ground or negative terminal.

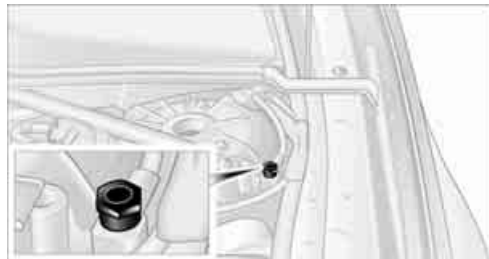

5. Attach the second end of the cable to the negative terminal of the battery or to the engine or body ground of the vehicle to be started.

Starting engine

1. Start the engine on the assisting vehicle and allow it to run at idle for several minutes at slightly increased speed.
2. Start the engine on the other vehicle in the usual way.
If the first starting attempt is not successful, wait a few minutes before another attempt in order to allow the discharged battery to recharge.
3. Let the engines run for a few minutes.
4. Disconnect the jumper cables by reversing the connection sequence.

Check the battery and recharge if necessary.

 Never use spray fluids to start the engine. ◀

Tow-starting and towing

 Observe applicable laws and regulations for tow-starting and towing. ◀

 Do not transport any passengers other than the driver in a vehicle that is being towed. ◀

Using tow fitting

Always keep the screw-in tow fitting with the vehicle. It can be screwed in at the front or rear of the BMW.

Sedan:

It is located in the toolkit in the luggage compartment lid, refer to page 243.

Sports Wagon:

It is located in the toolkit behind the left side panel in the cargo bay, refer to page 243.

⚠ Use only the tow fitting provided with the vehicle and screw it all the way in. Use the tow fitting for towing only on roads. Avoid lateral loading of the tow fitting, e.g. do not lift the vehicle by the tow fitting. Otherwise damage to the tow fitting and the vehicle can occur. ◀

Access to screw thread

Press the arrow symbol on the cover in the bumper.

Front



Rear



Being towed

⚠ Make sure that the ignition is switched on, refer to page 62, otherwise the low beams, tail lamps, turn signals and windshield wipers would not be available. Do not tow the vehicle with the rear axle raised, as otherwise the steering can turn to the left or right. When the engine is stopped, there is no power assist.

This then requires increased effort for braking and steering. Active steering is deactivated and larger steering wheel movements are required. ◀

Switch on the hazard warning flashers depending on the local regulations. If the electrical system fails, mark the vehicle to be towed, e.g. with a sign or warning triangle in the rear window.

Manual transmission

Gearshift lever in neutral position.

Automatic and sport automatic transmission

⚠ Before towing, manually release the transmission lock, even if there is no malfunction in the transmission. Otherwise there is a risk that the transmission lock will engage during towing. ◀

Manually unlocking and locking transmission lock, refer to page 66.

⚠ Do not exceed a towing speed of 45 mph / 70 km/h and a towing distance of 90 miles / 150 km; otherwise the automatic transmission may be damaged.

Towing methods

⚠ Do not lift vehicle by tow fitting or body and chassis parts, otherwise damage may result. ◀

In some countries, towing with tow bars or ropes in public traffic is not permitted. Familiarize yourself with the regulations on towing in the respective country.

With tow bar

⚠ The towing vehicle may not be lighter than the vehicle to be towed, otherwise it will not be possible to reliably control vehicle response. ◀

The tow fittings used should be on the same side on both vehicles. Should it prove impossible to avoid mounting the tow bar at an offset angle, please observe the following:

- ▷ Clearance and maneuvering capability will be sharply limited during cornering.

- ▷ When mounted at an angle, the tow bar will exert lateral forces, tending to push the vehicle sideways.

⚠ Only attach the tow bar to the tow fittings, as attachment to other vehicle parts can lead to damage. ◀

With tow rope

When starting off in the towing vehicle, make sure that the tow rope is taut.

⚠ To avoid jerking and the associated stresses on vehicle components when towing, always use nylon ropes or nylon straps. Only attach tow ropes to the tow fittings, as attachment to other vehicle parts can lead to damage. ◀

With tow truck

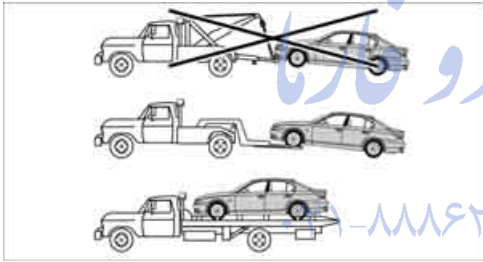

Have the BMW transported with a tow truck with a so-called lift bar or on a flat bed.

With a tow truck: xDrive

⚠ Do not tow a BMW with xDrive with just the front or rear axle raised, otherwise the wheels could lock up and the transfer case could be damaged. ◀

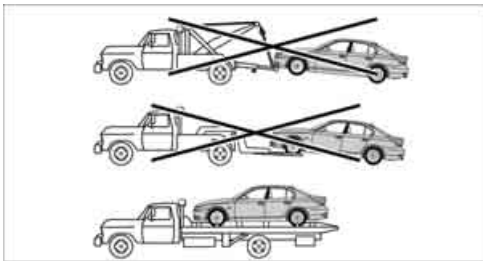

Have the BMW transported only on a flatbed surface.

Tow-starting

Do not tow-start the vehicle if possible, but instead start the engine by means of jump starting, refer to page 254. With a catalytic converter, tow-starting should only be carried out with the engine cold, and with automatic transmissions, the engine cannot be started by tow-starting.

1. Switch on the hazard warning flashers, comply with country-specific regulations.
2. Switch on the ignition, refer to page 62.
3. Shift into 3rd gear.
4. Tow-start with the clutch completely depressed and slowly release the clutch. After the engine starts, immediately depress the clutch again completely.
5. Stop at a suitable location, remove the tow bar or rope and switch off the hazard warning flashers.
6. Have the vehicle checked.



امداد خودرو فارما

تلفن شبانه روی: ۰۲۱-۸۸۸۶۲۰۸۵

FarmaSOS.com

Reference

- ◆ This chapter contains technical data, short commands for the voice command system and an index that will help you find information quickly.

امداد خودرو فارما

تلفن شبانه روزی: ۰۲۱-۸۸۸۶۲۰۸۵

FarmaSOS.com

Technical data

Engine data

		528i	535i	550i
Displacement	cu in/cm ³	182.8/2,996	181.8/2,979	292.8/4,799
No. of cylinders		6	6	8
Maximum output	hp	230	300	360
at engine speed	rpm	6,500	5,800	6,300
Maximum torque	lb ft/Nm	200/270	300/407	360/488
at engine speed	rpm	2,750	1,400-5,000	3,400

امداد خودرو فارما

تلفن شبانه روزی: ۰۲۱-۸۸۸۶۲۰۸۵

FarmaSOS.com

Dimensions

Sedan

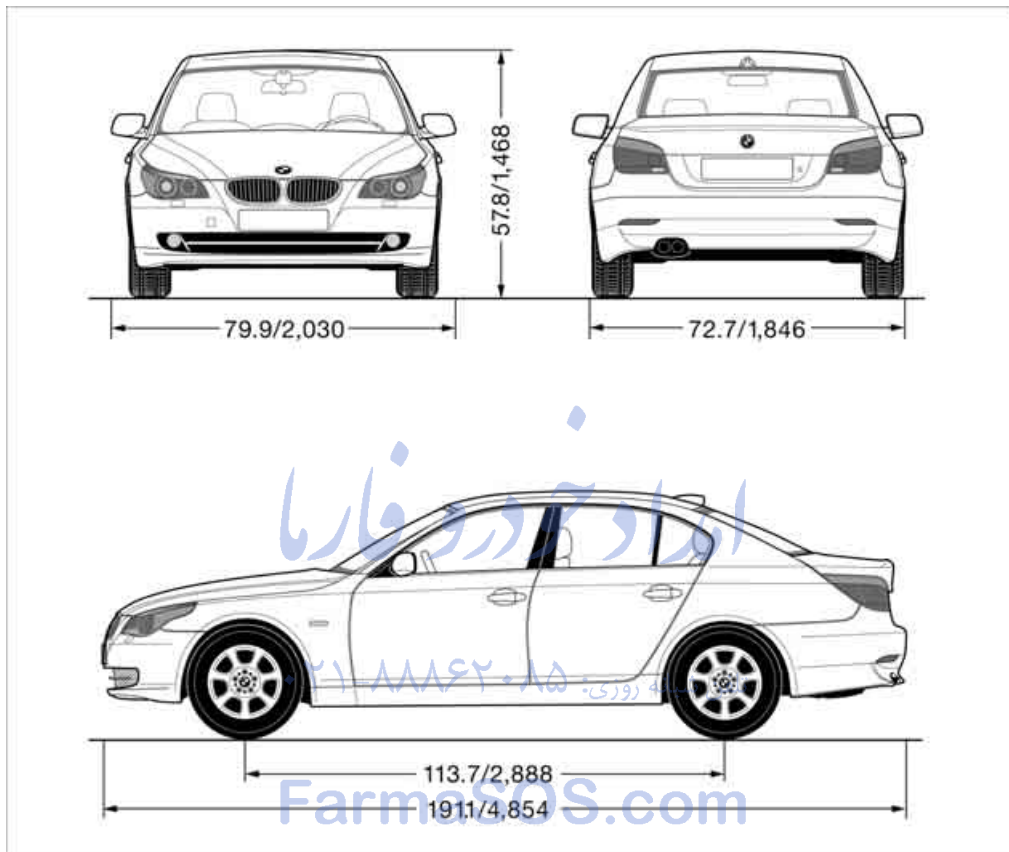

All dimensions are given in inches/mm.

Vehicle height with xDrive: 58.3 in/1,482 mm

Smallest turning circle diam.: 37.5 ft/11.4 m, with xDrive 39 ft/11.9 m

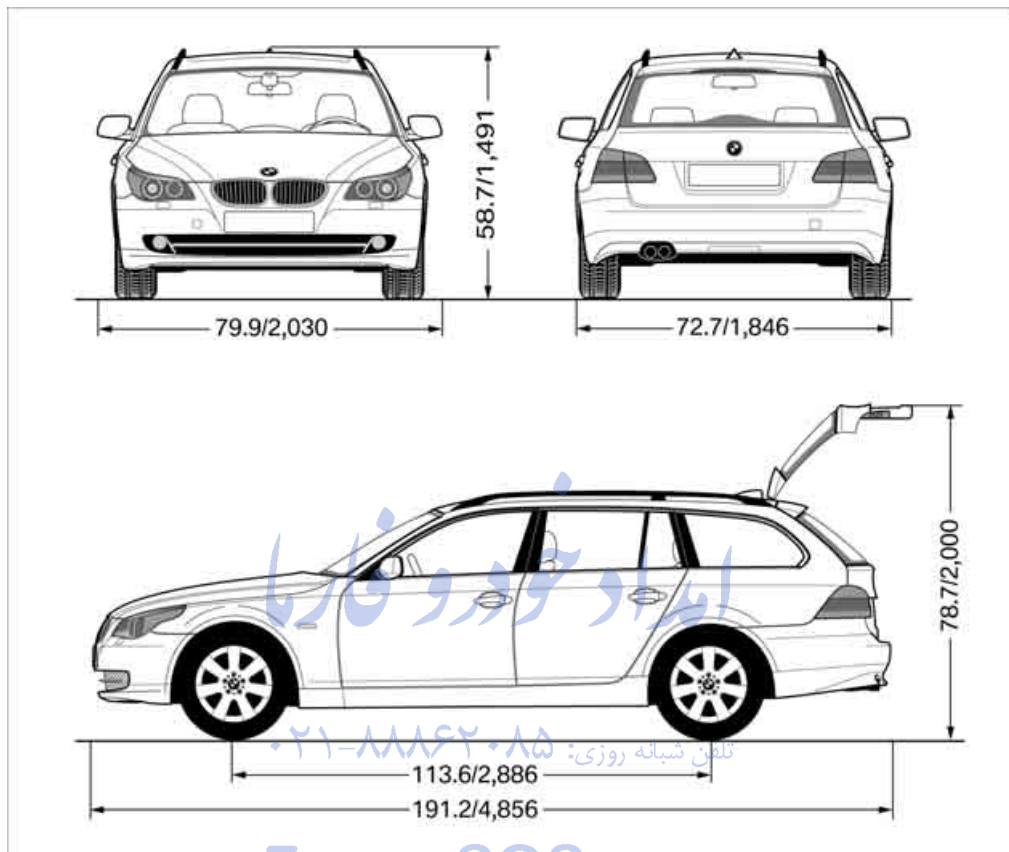

All dimensions given in inches/mm. Smallest turning circle diam.: 39 ft/11.9 m

Weights

Sedan		528i	535i	550i
Curb weight				
▷ Manual transmission	lbs./kg	3,505/1,590	3,660/1,660	3,946/1,790
▷ Automatic transmission	lbs./kg	3,571/1,620	3,703/1,680	3,968/1,800
Approved gross vehicle weight				
▷ Manual transmission	lbs./kg	4,607/2,090	4,872/2,210	5,048/2,290
▷ Automatic transmission	lbs./kg	4,673/2,120	4,872/2,210	5,070/2,300
Load	lbs./kg	1,102/500	1,102/500	1,102/500
Approved front axle load	lbs./kg	2,227/1,010	2,359/1,070	2,469/1,120
Approved rear axle load	lbs./kg	2,601/1,180	2,711/1,230	2,733/1,240
Approved roof load capacity	lbs./kg	220/100	220/100	220/100
Cargo bay capacity	cu ft/l	18.4/520	18.4/520	18.4/520

Never exceed either the approved axle loads or the gross vehicle weight.

Sedan		528i xDrive	535i xDrive
Curb weight			
▷ Manual transmission	lbs./kg	3,670/1,710	3,902/1,770
▷ Automatic transmission	lbs./kg	3,704/1,730	3,946/1,790
Approved gross vehicle weight			
▷ Manual transmission	lbs./kg	4,839/2,195	5,004/2,270
▷ Automatic transmission	lbs./kg	4,883/2,215	5,048/2,290
Load	lbs./kg	1,102/500	1,102/500
Approved front axle load	lbs./kg	2,315/1,050	2,315/1,050
Approved rear axle load	lbs./kg	2,689/1,220	2,689/1,220
Approved roof load capacity	lbs./kg	220/100	220/100
Cargo bay capacity	cu ft/l	18.4/520	18.4/520

Never exceed either the approved axle loads or the gross vehicle weight.

Sports Wagon		535i xDrive
Curb weight		
▷ Manual transmission	lbs./kg	4,100/1,860
▷ Automatic transmission	lbs./kg	4,144/1,880
Approved gross vehicle weight		
▷ Manual transmission	lbs./kg	5,291/2,400
▷ Automatic transmission	lbs./kg	5,335/2,420
Load	lbs./kg	1,190/540
Approved front axle load	lbs./kg	2,381/1,080
Approved rear axle load	lbs./kg	2,866/1,300
Approved roof load capacity	lbs./kg	220/100
Cargo bay capacity	cu ft/l	17.7-58.3/500-1,650

Never exceed either the approved axle loads or the gross vehicle weight.

Capacities

امداد خودرو فارما

			Notes
Fuel tank	US gal/liters	approx. 18.5/70	Fuel grade: page 221
of that reserve	US gal/liters	approx. 2.1/8	
550i	US gal/liters	approx. 2.6/10	
Window cleaning system			For more details: page 70
▷ Sedan	US quarts/liters	approx. 3.2/3	
▷ with headlamp cleaning system	US quarts/liters	approx. 5.3/5	
▷ Sports Wagon	US quarts/liters	approx. 5.3/5	

Short commands of voice command system*

With short commands you can run certain functions directly, regardless of which menu item is

selected. Here are the important short commands for the voice command system.

Assistance window

Function	Command
To open the assistance window 21	›Assistance window‹
To select the display in the assistance window 21	›Assistance window map facing north‹, ›Assistance window map direction of travel‹, ›Assistance window arrow display‹, ›Assistance window perspective‹, ›Assistance window current position‹, ›Assistance window trip computer‹ or ›Assistance window onboard info‹
To change scale in assistance window 142	›Assistance window scale ... feet‹ or ›Assistance window scale ... miles‹

Communication

Function	Command
To open phone 195	›Phone‹
To dial phone number 201	›Dial number‹
To display phone book 202	›A to Z‹
To select from the phone book 202	›Call ...‹ or ›Dial name‹
To display "Top 8" 203	›Top 8‹
To redial 202	›Redial‹
To display "Received calls" 203	›Received calls‹
To display "Missed calls" 203	›Missed calls‹
To display "Bluetooth" 197	›Bluetooth‹
To open BMW Service, Services 209	›BMW service‹

Navigation

Function	Command
To open navigation system 142	›Navigation‹
To open "Enter address" 144	›Enter address‹
To open "New destination" 144	›New destination‹
To display "Input map" 149	›Input map‹

Function	Command
To display destination list 151	›Destination list‹
To display address book 152	›Address book‹
To display route criteria 154	›Route preference‹
To start destination guidance 156	›Start guidance‹
To end destination guidance 156	›Stop guidance‹
To display arrow display 142	›Arrow display‹
To display map display 158	›Map‹, ›Map facing north‹, ›Map direction of travel‹ or ›Perspective‹
To change scale 158	›Scale ... miles‹ or ›Scale ... feet‹
To display roads or towns/cities along route 159	›Route list‹
To switch on voice instructions 159	›Navigation info on‹
To switch off voice instructions 159	›Navigation info off‹
To repeat voice instructions 160	›Repeat navigation info‹
To open route 157	›Route menu‹
To open "New route" 160	›New route‹
To display current position 163	›Current position‹

Onboard info

Function	Command
To open "Car Data" 81	›Car data‹
To display computer 81	›Onboard info‹
To display trip computer 81	›Trip computer‹
To open stopwatch 86	›Stopwatch‹
To open speed limit 86	›Limit‹
To activate speed limit 86	›Limit on‹
To deactivate speed limit 86	›Limit off‹

Entertainment

Function	Command
Tone control 169	›Audio‹
To switch on radio 172	›Radio on‹, ›FM‹ or ›AM‹
To open "FM" 172	›FM menu‹
To open "AM" 172	›AM menu‹

Function	Command
To open "All stations" 172	›FM all stations‹
To select radio station 172	›Station ...‹, e.g. ›Station WNYC‹, or ›Choose station‹
To open "Presets" 172	›FM presets‹ or ›AM presets‹
To select preset radio station 172	›Preset ...‹, e.g. ›Preset 1‹
To open "Manual" 173	›FM manual‹, ›AM manual‹ or ›Choose frequency‹, ›Frequency ... Megahertz‹
To open strongest radio stations 174	›AM Autostore‹
To open "WB" 176	›Weatherband menu‹
To switch on weatherband 176	›Weatherband on‹
To select a weatherband station 176	›Choose weatherband station‹
To open "SAT" 180	›SAT radio menu‹
To switch on satellite radio 179	›SAT radio‹
To open "Presets" of the satellite radio 180	›SAT radio presets‹
To open "All channels" of the satellite radio 180	›SAT radio all channels‹
To open "Categories" of the satellite radio 180	›SAT radio categories‹
To open CD player 182	›CD menu‹
To switch on CD player 182	›CD‹
To open CD changer 182	›CD changer menu‹
To switch on CD changer 182	›CD changer‹
To select a CD in the CD changer 182	›CD 1...6‹
To select music track 183	›CD track ...‹
To select a CD and music track in the CD changer 183	›CD 1...6 track ...‹
To switch on audio playback with external audio device 188	›Audio Aux‹

Climate

Function	Command
To adjust temperature distribution for front seat heating 53	›Seat heater distribution‹
To open "Vent settings" 116	›Vent settings‹
To open "Automatic programs" 115	›Automatic programs‹

Function	Command
To open "Parked car ventilation" 119	›Parked car operation⟨
To open "Automatic ventilation" 119	›Automatic ventilation⟨
To display activation times 119	›Activation time⟨

i menu

Function	Command
To open the i menu	›Settings menu⟨
"Display off" 22	›Display off⟨
To open "Info sources"	›Info sources⟨
To open "Settings"	›Settings⟨
To open "Door locks" 32, 35	›Door locks⟨
To open "Steering wheel buttons" 56	›Steering wheel buttons⟨
To open "Lighting" 68	›Lighting⟨
To open "Service requirements", 211 82	›Service requirements⟨
To open "Service" 82, 211	›Service⟨
To open "BMW Service settings" settings 214	›BMW service settings⟨
To display "Check Control messages" 85	›Check control messages⟨
To open "Head-Up Display" 102	›Head-Up Display⟨
To set brightness of Control Display 88	›Brightness⟨
To open "Units" 89	›Units⟨
To open "Language" 89, 142	›Language⟨
To open "Time" 87	›Time⟨
To open "Date" 88	›Date⟨
To open "PDC" 90	›PDC⟨
To open "FTM" 95	›FTM⟨
To open "TPM" 97	›TPM⟨
To display "Bluetooth" 197	›Bluetooth⟨
To open "HDC" 93	›HDC⟨
To activate BMW Night Vision 105	›Night Vision on⟨
To deactivate BMW Night Vision 105	›Night Vision off⟨
To display settings for BMW Night Vision 105	›Night Vision settings⟨

امداد خودرو فارما

تلفن شبانه روزی: ۰۲۱-۸۸۸۶۲۰۸۵

FarmaSOS.com

Everything from A to Z

Index

"..." Identifies Control Display texts used to select individual functions and refers you to the page where these texts can be found.

A

- ABS Antilock Brake System **91**
 - indicator lamp **94**
- ACC, refer to Active cruise control **71**
- Accepted calls **202**
- Accessories **6**
- Accident, refer to Emergency request **253**
- Acoustic signal, refer to Check Control **84**
- Activated-charcoal filter for automatic climate control **118**
- "Activation time" for parked car ventilation **119**
- Active cruise control **71**
 - indicator lamp **75**
 - radar sensors **75**
 - selecting distance **73**
 - warning lamps **75**
- Active front head restraints **51**
- Active seat **54**
- Active seat ventilation **54**
- Active steering **99**
 - warning lamp **100**
- Adapter for spare key **30**
- Adaptive brake assistant **92**
- Adaptive brake lamps, refer to Brake force display **100**
- Adaptive Head Light **110**
- "Add digits" in mobile phone mode **202**
- Additives
 - coolant **235**
 - engine oil, refer to Approved engine oils **235**
- "Address book" in navigation **152**
- Address for navigation
 - deleting **153**
 - entering **144, 147**
 - selecting **153**
 - storing **152**
 - storing current position **152**
- "Add to address book" **152**
- "Add to destination list" **147, 149**
- Adjusting active backrest width **49**
- Adjusting interior temperature **115**
- Adjusting the tone during audio operation, refer to Tone control **169**
- Adjusting thigh support **48**
- "After door opened" **50**
- "After unlocking" **50**
- Airbags **100**
 - indicator/warning lamp **102**
 - indicator lamp for front passenger airbags **101**
 - sitting safely **47**
- Air distribution
 - automatic **115**
 - manual **116**
- Airing, refer to Ventilation **118**
- Air recirculation
 - AUC Automatic recirculated-air control **117**
 - recirculated-air mode **117**
- Air recirculation, refer to Recirculated-air mode **117**
- "Air recirculation on / off" **57**
- Air supply, automatic climate control **114**
- Air volume **116**
- AKI, refer to Fuel quality **221**
- Alarm system **39**
 - avoiding unintentional alarms **40**
 - interior motion sensor **40**
 - switching off alarm **40**
 - switching off tilt alarm sensor and interior motion sensor **40**
 - tilt alarm sensor **40**
- "All channels" **180**
- "All doors" **33**
- Alloy wheels **240**
- All-season tires, refer to Winter tires **230**
- "All stations", requesting in radio mode **172**
- All-wheel drive, refer to xDrive **93**
- Alterations, technical, refer to For your own safety **5**
- Altering stretch of road **160**
- "AM", reception range **168, 172**
- Antenna for mobile phone **194**
- Antifreeze
 - coolant **235**
 - washer fluid **70**
- Anti-theft alarm system, refer to Alarm system **39**
- Anti-theft system, refer to Central locking system **32**
- Approved axle loads, refer to Weights **263**
- Approved engine oils **235**
- Approved gross vehicle weight, refer to Weights **263**
- Armrest, refer to Center armrest, rear **127**

Around the center console **14**
Around the steering wheel **10**
Arrival time
– refer to Computer **81**
– refer to Starting destination guidance **156**
"Arrow display" in navigation **157**
"Arrow display pop-up instructions" **143**
Ashtray
– front **125**
– rear **126**
Assist, refer to
BMW Assist **209**
Assistance systems, refer to
Driving stability control systems **91**
Assistance window **21**
"Assist. window off" **22**
AUC Automatic recirculated-air control **117**
Audio **168, 171, 176**
– controls **168**
– switching on/off **168**
– tone control **169**
– volume **169**
Audio device, external **124**
Automatic
– air distribution **115**
– air volume **115**
– cruise control **71**
– garage door opener **121**
– headlamp control **108**
– service notification **211**
– steering wheel adjustment **49**
– storing stations **174**
– tailgate operation **38**
Automatic car washes **136**
Automatic climate control **114**
– automatic air distribution **115**
– parked car ventilation **118**
– switching on and off **118**
– ventilation in rear **118**

Automatic closing of doors, refer to Automatic soft closing **35**
Automatic curb monitor **55**
Automatic lighting
– refer to Automatic headlamp control **108**
– refer to Daytime running lamps **109**
– refer to Interior lamps **112**
– refer to Pathway lighting **109**
– refer to Welcome lamps **108**
Automatic lights
– refer to High-beam assistant **110**
Automatic low beams, refer to
High-beam assistant **110**
"Automatic programs" **115**
Automatic roll-up cover, Sports Wagon **128**
Automatic soft closing **35**
Automatic speed reduction for descents, refer to HDC Hill Descent Control **93**
Automatic station search **173**
Automatic transmission with
Steptronic **64**
– interlock **65**
– kick-down **65**
– manually unlocking and locking transmission lock **66**
– shiftlock **65**
– towing **256**
– tow-starting **257**
– with comfort access **42**
"Automatic ventilation" **119**
AUTO program for automatic climate control **115**
"Auto Request" **211**
"Autostore" on the radio **172, 174**
"AUX" **168, 188, 190**
AUX-IN connection **188**
"AUX IN" in audio mode **188**
Average fuel consumption **80**
– setting units **89**
Average speed, refer to
Computer **80**

"Avoid ferries" in navigation **155**
"Avoid highways" in navigation **155**
Avoiding freeways for navigation **154**
Avoiding unintentional alarms **40**
"Avoid tollroads" in navigation **155**
Axle loads, refer to
Weights **263**
"A - Z" **202**

B

Backrest contour, refer to
Lumbar support **49**
Backrests, refer to Seats **48**
Backrest width adjustment **48**
Back seats, refer to Rear seats
Backup lamps, replacing
bulbs **246**
"Balance", tone control **170**
Band-aids, refer to First-aid
kit **254**
Bass, refer to Tone
control **169**
"Bass", tone control **169**
Battery, refer to Vehicle
battery **251**
– jump starting **254**
Battery replacement
– remote control for comfort
access **42**
BC button, refer to
Computer **80**
Being towed **256**
Belts, refer to Safety belts **52**
Beverage holder, refer to Cup
holders **125**
Blower, refer to Air
volume **116**
"Bluetooth" **195**
BMW
– Car Shampoo **241**
"BMW Assist" **210, 211**

- BMW Assist 209
 - activating 215
 - BMW TeleServices 211
 - concierge service 212
 - contacting BMW Customer Relations 212
 - displaying vehicle data 216
 - offered services 209
 - roadside assistance 210
 - updating 214
 - BMW Assist My Info 213
 - "BMW Contact" 204
 - "BMW Contact Numbers" 204
 - BMW homepage 4
 - BMW maintenance system 237
 - BMW Night Vision 104
 - activating 105
 - cleaning camera 106
 - cleaning camera, refer to Wiper system 69
 - deactivating 105
 - making settings 105
 - "BMW Service settings" 214
 - BMW TeleServices 211
 - BMW TeleServices services
 - displaying 212
 - updating 212
 - BMW website 4
 - Bottle holder, refer to Cup holders 125
 - Bracket for telephone or mobile phone
 - refer to Snap-in adapter 207
 - Brake assistant 91
 - adaptive 92
 - Brake force display 100
 - Brake lamps
 - replacing bulbs 246
 - two-stage 100
 - Brake rotors
 - breaking-in 134
 - refer to Braking safely 136
 - Brakes
 - ABS Antilock Brake System 91
 - brake assistant 91
 - brake force display 100
 - breaking-in 134
 - CBC Cornering Brake Control 91
 - electronic brake-force distribution 91
 - handbrake 64
 - refer to Braking safely 136
 - warning lamps 13
 - Brake system 134
 - brake pads 134
 - breaking-in 134
 - disk brakes 136
 - warning lamp 94
 - Braking safely 136
 - Breakdown services, refer to Roadside Assistance 254
 - Breaking-in brake pads 134
 - Breaking-in the clutch 134
 - Breaking-in the differential, refer to Engine and differential 134
 - Break-in period 134
 - "Brightness" 89, 103
 - Brightness of Control Display 88
 - "Brightness" with BMW Night Vision 106
 - Button for starting engine, refer to Start/Stop button 62
 - Buttons on steering wheel 11
- C**
- California Proposition 65 Warning 6
 - "Call" 202, 213
 - Call
 - accepting 200
 - displaying accepted 203
 - ending 201
 - in absence 203
 - rejecting 201
 - starting 201
 - Calling
 - by entering phone number 201
 - from phone book 202
 - from Top 8 list 203
 - redialing 203
 - refer to telephone operating instructions
 - Can holder, refer to Cup holders 125
 - Capacities 264
 - Car battery, refer to Vehicle battery 251
 - "Car Data" 81
 - Care 239
 - car-care products 239
 - carpets 241
 - car washes 239
 - CD/DVD-player 242
 - chrome components 240
 - displays 241
 - exterior 239
 - fine wooden components 241
 - hand washing 240
 - headlamps 240
 - high-pressure cleaning jets 239
 - interior 241
 - leather 241
 - light-alloy wheels 240
 - paint 240
 - plastic components 241
 - rubber gaskets 240
 - safety belts 241
 - sensors and cameras 241
 - upholstery and cloth-covered paneling 241
 - windows 240
 - wiper blades 240
 - Cargo
 - refer to Cargo loading 137
 - securing 138
 - securing with ski bag 131

- Cargo bay
 - capacity [263](#)
 - emergency operation, refer to Opening manually, Sports Wagon [38](#)
 - emergency release [37](#)
 - expanding, Sports Wagon [128](#)
 - floor panel flap, refer to Compartment in floor, Sports Wagon [129](#)
 - locking separately [36](#)
 - opening/closing, refer to Luggage compartment lid/tailgate [36](#)
 - opening from inside [36](#)
 - opening from inside, Sports Wagon [37](#)
 - opening from outside [36](#)
 - opening from outside, Sports Wagon [37](#)
 - opening with remote control [33](#)
- Cargo bay cover, refer to Roll-up cover [128](#)
- Caring for the vehicle finish [240](#)
- Car key, refer to Keys/remote control [30](#)
- Car phone [194](#)
 - installation location, refer to Center armrest [123](#)
 - refer to Mobile phone [194](#)
 - refer to separate operating instructions
- Car radio, refer to Radio [172](#)
- Car Shampoo [241](#)
- Car wash [63](#), [136](#)
 - with comfort access [42](#)
- Car washes [239](#)
- Catalytic converter, refer to Hot exhaust system [135](#)
- "Categories" [180](#)
- CBC Cornering Brake Control [91](#)
- CBS Condition Based Service [237](#)
- "CD" [168](#), [182](#)
- CD changer [182](#)
 - controls [168](#)
 - fast forward/reverse [186](#)
 - installation location [186](#)
 - install sequence [185](#)
 - repeating a track [185](#)
 - sampling tracks [184](#)
 - selecting a CD [182](#)
 - selecting a track [183](#)
 - switching on/off [168](#)
 - tone control [169](#)
 - volume [169](#)
- CD player [182](#)
 - controls [168](#)
 - fast forward/reverse [186](#)
 - random sequence [185](#)
 - repeating a track [185](#)
 - sampling a track [184](#)
 - selecting a track [183](#)
 - switching on/off [168](#)
 - tone control [169](#)
 - volume [169](#)
- Center armrest
 - front [123](#)
 - rear [127](#)
- Center brake lamp [247](#)
- Center console [14](#)
- "Central locking" [32](#)
- Central locking
 - from inside [35](#)
 - from outside [32](#)
- Central locking system [32](#)
 - comfort access [40](#)
- Changes, technical, refer to For your own safety [5](#)
- Changes, technical, refer to Parts and accessories [6](#)
- Changing language on Control Display [89](#)
- Changing scale for navigation [158](#)
- Changing units of measure on Control Display [89](#)
- Changing wheels [229](#), [248](#)
- CHECK button [85](#)
- Check Control [84](#)
- "Check Control messages" [85](#)
- Check Gas Cap [221](#)
- Checking the air pressure, refer to Tire inflation pressure [222](#)
- Child restraint fixing system LATCH [59](#)
- Child restraints [58](#)
- Child restraint systems [58](#)
- Child-safety lock [61](#)
- Child seats, refer to Transporting children safely [58](#)
- Chime, refer to Check Control [84](#)
- Chock [249](#)
- Chrome-plated parts [241](#)
- Chrome polish [241](#)
- Cigarette lighter [125](#)
- Cigarette lighter socket, refer to Connecting electrical devices [126](#)
- Cleaning your BMW, refer to Care [239](#)
- "Climate" [53](#), [115](#)
- Clock [79](#)
 - 12h/24h format [88](#)
 - hour signal [88](#)
 - setting time and date [87](#)
- Closing
 - from inside [35](#)
 - from outside [32](#)
- Closing fuel filler cap [221](#)
- Clothes hooks [124](#)
- Cockpit [10](#)
- Cold start, refer to Starting engine [63](#)
- Comfort access [40](#)
 - observe in car wash [42](#)
 - replacing battery, remote control [42](#)
- Comfort area, refer to Around the center console [14](#)
- Comfort seat [48](#)
- "Communication" [200](#), [210](#), [211](#), [213](#)
- Compact Disc
 - refer to CD changer [182](#)
 - refer to CD player [182](#)

- Compact wheel
 - inflation pressure [223, 224](#)
 - wheel change [250](#)
 - Compartment for remote control, refer to Ignition lock [62](#)
 - Compartments
 - in cargo bay, Sports Wagon [129](#)
 - refer to Storage area package, Sports Wagon [130](#)
 - refer to Storage compartments [124](#)
 - Compressed audio files [182](#)
 - Computer [80](#)
 - displays on Control Display [81](#)
 - hour signal [88](#)
 - "Concert hall", tone control [171](#)
 - "Concierge" [213](#)
 - Concierge service [212](#)
 - Condensation, refer to When vehicle is parked [136](#)
 - Condition Based Service CBS [237](#)
 - "Confirmation" [34](#)
 - Confirmation signals for locking and unlocking [33](#)
 - Connecting car vacuum cleaner, refer to Connecting electrical devices [126](#)
 - Consumption, refer to
 - Average fuel consumption [80](#)
 - Consumption indicator
 - Energy Control [80](#)
 - Consumption statistics, refer to Average fuel consumption [80](#)
 - "Continue guidance to destination?" [157](#)
 - "Contrast" with BMW Night Vision [106](#)
 - Control Center, refer to iDrive [16](#)
 - Control Display, refer to
 - iDrive [16](#)
 - setting brightness [88](#)
 - switching off/on [22](#)
 - Controller, refer to iDrive [16](#)
 - Controls, refer to Cockpit [10](#)
 - Convenient operation
 - glass sunroof [33](#)
 - windows [33](#)
 - windows and glass sunroof with comfort access [41](#)
 - Coolant [235](#)
 - checking level [235](#)
 - temperature [79](#)
 - Cooling, maximum [117](#)
 - Cooling fluid, refer to
 - Coolant [235](#)
 - Cooling function, automatic climate control [117](#)
 - Cooling system, refer to
 - Coolant [235](#)
 - Copyright [2](#)
 - Cornering Brake Control CBC [91](#)
 - Country of destination for navigation [145](#)
 - Courtesy lamps [112](#)
 - Cradle for telephone or mobile phone [123](#)
 - Cruise control [70](#)
 - active cruise control [71](#)
 - Cruising range [80](#)
 - Cup holders [125](#)
 - Curb weight, refer to
 - Weights [263](#)
 - Current consumption, refer to
 - Energy Control [80](#)
 - Current position
 - displaying [163](#)
 - entering [152](#)
 - storing [152](#)
 - "Curve mode" with BMW Night Vision [106](#)
 - "Customer Relations" [204, 212](#)
 - Cylinders, refer to Engine data [260](#)
- ## D
- Dashboard, refer to
 - Cockpit [10](#)
 - Data, technical [260](#)
 - dimensions [261](#)
 - engine [260](#)
 - weights [263](#)
 - Date [79, 88](#)
 - date format [88](#)
 - retrieval [79](#)
 - setting [88](#)
 - "Date format" [88](#)
 - Daytime running lamps [109](#)
 - "Deactivated" [51](#)
 - Defect
 - door lock [34](#)
 - fuel filler door [220](#)
 - glass sunroof [44](#)
 - luggage compartment lid [36](#)
 - panorama glass sunroof [46](#)
 - tailgate [38](#)
 - Defrosting windows [116](#)
 - Defrosting windows and removing condensation [116](#)
 - Defrosting windshield, refer to
 - Defrosting windows [116](#)
 - Defrost position, refer to
 - Defrosting windows [116](#)
 - "Delete address book" in navigation [154](#)
 - "Delete all numbers" in mobile phone mode [203](#)
 - "Delete data" in navigation [154](#)
 - "Delete" in mobile phone mode [203](#)
 - Destination address
 - deleting [153](#)
 - entering [144, 147](#)
 - Destination for navigation
 - destination list [151](#)
 - entering via voice [147](#)
 - entry [144](#)
 - selecting from address book [153](#)
 - selecting using information [150](#)
 - storing [152](#)

Destination guidance **156**
– bypassing route sections **160**
– canceling voice instructions **57**
– changing specified route **154**
– displaying route **157**
– distance and arrival **156**
– interrupting **156**
– starting **156**
– terminating/continuing **156**
– voice instructions **159**
– volume of voice instructions **160**
Destination list for navigation **151**
Destinations recently driven to **151**
"Details" in audio mode **184, 190**
"Details" in radio mode **180**
"Detour" in navigation **163**
"Dial" in mobile phone mode **201**
"Dial number" **201**
"Diamond button" **57**
Diamond button **56**
Digital clock **79**
Digital radio, refer to High Definition Radio **176**
Dimensions **261**
Directional indicators, refer to Turn signals **68**
Direction announcements, refer to Voice instructions **159**
Direction instructions, refer to Voice instructions **159**
Directory, refer to Phone book **202**
Directory for navigation, refer to Address book **152**
Displacement, refer to Engine data **260**
"Display" **89**
Display, refer to iDrive controls **16**

Display elements, refer to Instrument cluster **12**
Displaying vehicle data **216**
Display lighting, refer to Instrument lighting **112**
"Display off" **22**
Displays
– on Control Display, refer to iDrive **16**
– refer to Instrument cluster **12**
"Display settings" **88, 103**
Displays on the windshield, refer to Head-Up Display **102**
Disposal
– battery of remote control with comfort access **42**
– coolant **235**
– vehicle battery **251**
Distance, refer to Computer **81**
Distance control, refer to Active cruise control **71**
"Distance to dest." **81**
Distance to destination, refer to Computer **81**
Distance warning, refer to PDC Park Distance Control **90**
Divided rear backrest, refer to Through-loading system **127**
Door entry lighting **112**
Door key, refer to Keys/remote control **30**
Door lock **34**
Door locking, confirmation signals **33**
"Door locks" **32**
Doors
– manual operation **34**
– remote control **32**
DOT Quality Grades **228**
Draft-free ventilation **118**
Drinks holder, refer to Cup holders **125**
"Driver's door only" **33**

Driving lamps, refer to Parking lamps/low beams **108**
Driving route, refer to Displaying route **157**
Driving stability control systems **91**
Driving through water **136**
Driving tips, refer to General driving notes **134**
Dry air, refer to Cooling function **117**
Drying the air, refer to Cooling function **117**
DSC Dynamic Stability Control **92**
– indicator lamp **13, 92**
– malfunction **94**
DTC Dynamic Traction Control **92**
– activating **92**
– indicator lamp **13, 92**
DVD for navigation **142**
Dynamic Brake Control DBC
– warning lamp **94**
Dynamic Drive **94**
Dynamic Driving Control **67**
"Dynamic route" in navigation **155**
Dynamic Stability Control DSC **92**
Dynamic Traction Control DTC **92**

E

Easy entry/exit **56**
– backrest width **49**
Eject button, refer to Buttons in area of CD player **168**
Electrical malfunction
– door lock **34**
– driver's door **34**
– fuel filler door **220**
– glass sunroof, electric **44**
– luggage compartment lid **36**
– panorama glass sunroof **46**
– tailgate **38**
Electric steering wheel adjustment **56**

- Electronic brake-force distribution **91**
- Electronic oil level check **234**
- Emergency operation, refer to Manual operation
- door lock **34**
 - driver's door **34**
 - fuel filler door **220**
 - luggage compartment lid **36**
 - tailgate **38**
 - transmission lock, automatic transmission **66**
- Emergency operation, refer to Moving manually
- glass sunroof **44**
 - panorama glass sunroof **46**
- Emergency release for luggage compartment lid in cargo bay **37**
- Emergency request **253**
- Emergency services, refer to Roadside Assistance **254**
- "Enabled services" **215**
- "Enabled TeleServices" **212**
- "Enable services" **215**
- "End call" **202**
- Energy-conscious driving, refer to Energy Control **80**
- Energy Control **80**
- Engine
- breaking-in **134**
 - data **260**
 - overheated, refer to Coolant temperature **79**
 - speed **260**
 - starting **63**
 - starting, with comfort access **40**
 - switching off **63**
- Engine compartment **233**
- Engine coolant **235**
- Engine oil
- adding **235**
 - additives, refer to Approved engine oils **235**
 - approved engine oil **235**
 - checking oil level **234**
 - electronic oil level check **234**
 - interval between changes, refer to Service requirements **82**
 - oil change **235**
 - oil grades, refer to Approved engine oils **235**
 - "Engine oil level" **234**
- Engine output, refer to Engine data **260**
- Engine overheating, refer to Coolant temperature **79**
- Engine speed, refer to Engine data **260**
- Engine starting, refer to Starting engine **63**
- "Enter address" **144, 152**
- Entering destination via town/city name **145**
- Entering intersection, navigation **146**
- Entering the address **144, 147**
- Entering town/city for navigation **145**
- Entering zip code for navigation **146**
- "Entertainment" **168**
- Entertainment sound output on/off **169**
- Entry map for destination **149**
- Environmentally friendly driving
- refer to Energy control **80**
- Equalizer, refer to Tone control **171**
- "Equalizer", tone control **171**
- "ESN" **179**
- ESP Electronic Stability Program, refer to DSC Dynamic Stability Control **92**
- Event Data Recorders **238**
- Exhaust system, refer to Hot exhaust system **135**
- Exterior mirrors **54**
- adjusting **54**
 - automatic dimming feature **56**
 - automatic heating **55**
 - folding in and out **55**
 - tilting down passenger-side exterior mirror **55**
- External audio device **124**
- Eye for tow-starting and towing, refer to Tow fitting **255**
- ## F
- Fader, refer to Tone control **170**
- "Fader", tone control **170**
- Failure messages, refer to Check Control **84**
- False alarm
- refer to Avoiding unintentional alarms **40**
 - refer to Switching off alarm **40**
- Fastening safety belts, refer to Safety belts **52**
- warning lamp **52**
- Fastest route for navigation **154**
- "Fast route" in navigation **155**
- Filler neck for washer fluid **70**
- Filter, refer to Microfilter/activated-charcoal filter **118**
- First aid, refer to First-aid kit **254**
- First-aid kit **254**
- Flashing
- during locking/unlocking, refer to Setting confirmation signals **33**
 - triple turn signal activation **68**

Flat tire
– changing wheels **248**
– compact wheel **250**
– Flat Tire Monitor **95, 96**
– refer to Tire condition **229**
– run-flat tires **96, 98, 229**
– TPM Tire Pressure Monitor **97**
– warning lamp **96, 98**
Flat Tire Monitor **95**
– false alarms **95**
– initializing system **95**
– snow chains **231**
– system limits **95**
– warning lamp **96**
Fluid reservoir, refer to Filler neck for washer fluid **70**
"FM", reception range **168, 172**
FM, waveband **172**
Fog lamps **112**
– indicator lamp **13, 112**
Folding rear backrest **127**
– Sports Wagon **128**
Folding rear backrest, Sports Wagon **128**
Fold-over rear backrest **127**
Footbrake, refer to Braking safely **136**
Footwell lamps, refer to Interior lamps **112**
Forward, fast
– CD changer **186**
– CD player **186**
For your own safety **5**
4-wheel drive system, refer to xDrive **93**
Freeway, refer to Route criteria **154**
Front airbags **100**
Front armrest, refer to Center armrest, front **123**
Front passenger airbags
– deactivating **101**
Front seat adjustment **48**
"FTM" **96**
FTM, refer to Flat Tire Monitor **95**

Fuel **221**
– average consumption **80**
– display **80**
– high-quality brands **221**
– quality **221**
– specifications **221**
– tank contents, refer to Capacities **264**
Fuel clock, refer to Fuel gauge **80**
Fuel consumption display
– computer, average fuel consumption **80**
Fuel display, refer to Fuel gauge **80**
Fuel-efficient driving
– refer to Energy control **80**
– refer to Saving fuel **134**
Fuel filler door **220**
– releasing in the event of electrical malfunction **220**
Full mobile phone preparation package **194**
Full screen display, refer to Switching assistance window off **22**
"Full screen" with BMW Night Vision **106**
Fuses **251**

Garage door opener, refer to Integrated universal remote control **121**
Gasoline, refer to Required fuel **221**
Gasoline display, refer to Fuel gauge **80**
Gearshift lever
– manual transmission **64**
General driving notes **134, 135**

Glass sunroof, electric **43**
– convenient operation from outside **34**
– convenient operation with comfort access **41**
– moving manually **44**
– remote control **33**
Glove compartment **123**
– lighting **123**
GPS navigation, refer to Navigation system **142**
Grills, refer to Ventilation **118**
Gross vehicle weight, refer to Weights **263**

H

Halogen lamps **245**
Handbrake **64**
– indicator lamp **13, 64**
Hands-free system, refer to Microphone **14**
Hand washing **240**
Hazard warning flashers **15**
"HDC" **93**
HDC Hill Descent Control **93**
"HDC on" **93**
"HDC on / off" **57**
"HD radio" **176**
HD radio, refer to High Definition Radio **176**
Head airbags **100**
Headlamp
– cleaning tank, refer to Capacities **264**
Headlamp control, automatic **108**
Headlamp flasher **68**
Headlamps **108**
– cleaning, refer to Wiper system **69**
– filler neck for washer fluid **233**
– replacing bulbs **245**
Head Light, refer to Adaptive Head Light **110**

- Head restraints **51**
 - active front head restraints **51**
 - removing **52**
 - sitting safely **47**
 - Head-Up Display **102, 103**
 - Heated
 - mirrors **55**
 - rear window **116**
 - seats **53**
 - steering wheel **56**
 - Heating **114**
 - exterior mirrors **55**
 - interior **114**
 - rear window **116**
 - residual heat **117**
 - seats **53**
 - steering wheel **56**
 - Heating with engine switched off, refer to Residual heat **117**
 - Heavy cargo, refer to Securing cargo **138**
 - Height, refer to Dimensions **261**
 - Height adjustment
 - seats **48**
 - steering wheel **56**
 - High-beam assistant **110, 112**
 - High beams **110**
 - headlamp flasher **110**
 - indicator lamp **13**
 - replacing bulbs **245**
 - High Definition Radio **176**
 - High-pressure cleaning jets **239, 240**
 - High water, refer to Driving through water **136**
 - Hill Descent Control HDC **93**
 - Hills **136**
 - Holder for cups **125**
 - "Home address" in navigation **154**
 - Homepage of BMW **4**
 - Hood **232**
 - Hooks for shopping bags, Sports Wagon **130**
 - Horn **10**
 - Hotel function, refer to Locking separately **36**
 - Hot exhaust system **135**
 - "Hour memo" **88**
 - "House number" in destination entry **147**
 - Hydraulic brake assistant, refer to Brake assistant **91**
 - Hydroplaning **135**
- I**
- IBOC, refer to High Definition Radio **176**
 - Ice, refer to Outside temperature warning **79**
 - ID3 tag, refer to Information on track **184**
 - Identification mark
 - recommended tire brands **230**
 - run-flat tires **229**
 - tire coding **227**
 - iDrive **16**
 - assistance window **21**
 - automatic climate control with expanded scope **115**
 - changing date and time **87**
 - changing language **89**
 - changing menu page **20**
 - changing settings **87**
 - changing units of measure and display type **89**
 - confirming selection or entry **20**
 - controller **16**
 - controls **16**
 - displays, menus **18**
 - operating principle **18**
 - selecting menu item **20**
 - setting brightness **88**
 - start menu **18**
 - status information **21**
 - symbols **19**
 - Ignition **62**
 - switched off **63**
 - switched on **62**
 - Ignition key, refer to Keys/remote control **30**
 - Ignition key position 1, refer to Radio readiness **62**
 - Ignition key position 2, refer to Ignition on **62**
 - Ignition lock **62**
 - starting engine with comfort access **42**
 - i menu **18**
 - Imprint **2**
 - Indicator/warning lamps
 - ABS Antilock Brake System **94**
 - active steering **100**
 - airbags **102**
 - brake system **94**
 - DSC **13, 92**
 - DTC **13, 92**
 - Flat Tire Monitor **96**
 - fog lamps **13**
 - safety belt warning **52**
 - TPM Tire Pressure Monitor **98**
 - Indicator and warning lamps **13**
 - Inflation pressure, refer to Tire inflation pressure **222**
 - Inflation pressure monitoring, refer to Flat Tire Monitor **95**
 - Inflation pressure monitoring, refer to TPM Tire Pressure Monitor **97**
 - Info menu **18**
 - Information
 - on another location **150**
 - on current position **150**
 - on destination location **150**
 - "Information" in navigation **150**
 - Information menu, refer to i menu **18**
 - "Information on destination" **152**
 - "Info sources" **82**

Initializing
 – Flat Tire Monitor **95**
 – radio, refer to Storing stations **174**
 – refer to Power failure **251**
 – refer to Setting time and date **87**
 – seat, mirror and steering wheel memory **49**
 "Input map" **149**
 Installation location
 – CD changer **186**
 – drive for navigation DVD **142**
 – mobile phone **123**
 Instructions for navigation system, refer to Voice instructions **159**
 Instrument cluster **12**
 Instrument illumination, refer to Instrument lighting **112**
 Instrument lighting **112**
 Instrument panel, refer to Cockpit **10**
 Instrument panel, refer to Instrument cluster **12**
 Integrated key **30**
 Integrated universal remote control **121**
 Interesting destination for navigation **150**
 "Interim time" **87**
 Interior lamps **112**
 – switching on with remote control **33**
 Interior motion sensor **40**
 – switching off **40**
 Interior rearview mirror **55**
 – automatic dimming feature **56**
 Intermittent mode of the wipers **69**

J

Jacking points **250**
 Joystick, refer to iDrive **16**
 Jumping, refer to Jump starting **254**
 Jump starting **254**

K

Keyless-Go, refer to Comfort access **40**
 Keyless opening and closing, refer to Comfort access **40**
 Key Memory, refer to Personal Profile **31**
 "Keypad" **204**
 Keys **30**
 – key-related settings, refer to Personal Profile **31**
 – spare key **30**
 Kick-down, Automatic transmission with Steptronic **65**
 Knock control **221**

L

Lamps
 – refer to High-beam assistant **110**
 – refer to Parking lamps/low beams **108**
 Lamps and bulbs **243**
 Lane limit lines, refer to Leaving lane warning **106**
 "Language / Units" **89**
 "Language / Units" in navigation **143, 159**
 "Languages" **89**
 "Languages" in navigation **143, 159**
 Lashing eyes, refer to Securing cargo **138**
 Last destinations, refer to Destination list **151**
 "Last seat pos." **50**
 LATCH child restraint fixing system **59**
 Leather care **241**
 Leaving lane warning **106**
 LEDs light-emitting diodes **244**
 Length, refer to Dimensions **261**
 License plate lamp, replacing bulbs **248**
 Light-emitting diodes LEDs **244**
 Lighter **125**
 "Lighting" **68**
 Lighting
 – instruments **112**
 – lamps and bulbs **243**
 – of the vehicle, refer to Lamps **108**
 Light switch **108**
 "Limit" **86**
 Loading
 – securing cargo **138**
 – stowing cargo **138**
 – vehicle **137**
 Load securing equipment, refer to Securing cargo **138**
 "Lock after driving" **35**
 Lock buttons in the doors, refer to Lokking **35**
 Locking **33**
 – confirmation signals **33**
 – from inside **35**
 – from outside **33**
 – without key, refer to Comfort access **40**
 Locking and unlocking doors
 – confirmation signals **33**
 – from inside **35**
 – from outside **32**
 Low beams **108**
 – automatic **108**
 – replacing bulbs **245**
 Lower back support, refer to Lumbar support **49**
 Lug bolts **250**
 – tightening torque, refer to After mounting **250**
 – wrench **249**
 Luggage compartment, refer to Cargo bay

Luggage compartment lid **36**
 – emergency operation, refer to Manual operation **36**
 – emergency release **37**
 – locking separately **36**
 – opening from inside **36**
 – opening from outside **36**
 – unlocking and locking from inside **35**
 – unlocking manually **36**
 Luggage compartment lid/tailgate
 – comfort access **41**
 Luggage net, refer to Partition net **128**
 Luggage rack, refer to Roof-mounted luggage rack **139**
 Lumbar support **49**
 LW, waveband **172**

M

M+S tires, refer to Winter tires **230**
 Maintenance **237**
 – refer to Service and Warranty Information Booklet for US models **237**
 – refer to Service requirements **82**
 – refer to Warranty and Service Guide Booklet for Canadian models **237**
 Maintenance system **237**
 Malfunction warnings, refer to Check Control **84**
 Manual air distribution **116**
 "Manual" in radio mode **173**
 Manual operation
 – door lock **34**
 – driver's door **34**
 – fuel filler door **220**
 – glass sunroof **44**
 – luggage compartment lid **36**
 – panorama glass sunroof **46**
 – transmission lock, automatic transmission **66**
 Manual transmission **64**
 "Map direction of travel" **158**

Map display **158**
 "Map facing north" **158**
 Map for navigation
 – changing scale **158**
 – destination entry **149**
 Map view facing north **158**
 Master key, refer to Keys/remote control **30**
 Maximum cooling **117**
 Maximum speed
 – with compact wheel **251**
 Maximum speed with winter tires **230**
 Measurements, refer to Dimensions **261**
 Memory, refer to Seat, mirror and steering wheel memory **49**
 MENU, button refer to Start menu **18**
 Menus, refer to iDrive **16**
 Message list for traffic information **161**
 Microfilter **118**
 Microphone
 – for mobile phone **14, 16**
 – for telephone **14**
 – for voice command system **14**
 Mirror dimming feature **56**
 Mirrors **54**
 – automatic curb monitor **55**
 – folding in and out **55**
 – heating **55**
 – memory, refer to Seat, mirror and steering wheel memory **49**
 Missed calls **202, 203**

Mobile phone
 – accepted calls **203**
 – adjusting volume **200**
 – calling **201**
 – ending call **201**
 – installation location, refer to Center armrest **123**
 – missed calls **203**
 – operation by voice **205**
 – operation via iDrive **200**
 – redialing **203**
 – refer to separate operating instructions
 – Top 8 **203**
 – touch tone dialing, refer to Tone dialing method **204**
 Mobile phone, refer to separate operating instructions
 Mobile phone battery **208**
 Monitor, refer to iDrive **16**
 Monitoring pressure of tires, refer to Flat Tire Monitor **95**
 "Monitor on / off" **57**
 Most recent mobile phone numbers **203**
 MP3
 – compressed audio files **182**
 – USB-audio interface/mobile phone audio interface **189**
 Multi-function steering wheel, refer to Buttons on steering wheel **11**
 Multifunction switch
 – refer to Turn signals/headlamp flasher **68**
 – refer to Wiper system **69**
 Music tracks
 – finding **184**
 – random play sequence **185**
 – sampling, scan **184**
 "Mute on / off" **57**
 MW, waveband **172**
 "My Info" **214**
 My Info, refer to BMW Assist My Info **213**

N

- "Navigation" **81, 144**
- Navigation destination
 - entering manually **144**
 - home address **154**
 - selecting via map **149**
- Navigation drive, installation location **142**
- Navigation DVD **142**
- Navigation instructions, refer to Switching voice instructions on/off **159**
- Navigation system **142**
 - address book **152**
 - bypassing route sections **160**
 - destination entry **144**
 - destination guidance in assistance window **142**
 - destination list **151**
 - displaying current position **163**
 - displaying route **157**
 - entering a destination manually **144**
 - entering destination via voice **147**
 - last destinations **151**
 - navigation DVD **142**
 - route list **159**
 - searching for a special destination **150**
 - selecting destination using information **150**
 - selecting destination via map **149**
 - selecting route criteria **154**
 - starting destination guidance **156**
 - switching off, refer to Terminating/continuing destination guidance **156**
 - terminating/continuing destination guidance **156**
 - voice instructions **159**
 - volume adjustment **160**
- "Navigation voice instructions" **57, 159**
- Neck support, refer to Head restraints **51**
- "New address" in navigation **152**
- "New destination" **144, 149**
- New remote control **30**
- "New route" **160**
- New wheels and tires **229**
- "Next entertainment source" **57**
- Night Vision, refer to BMW Night Vision **104**
- Night vision device, refer to BMW Night Vision **104**
- "Night Vision off" **106**
- "Night Vision on / off" **57**
- Nozzles, refer to Windshield washer nozzles **70**
- Nylon rope, refer to Tow-starting and towing **255**
- OB
OBD socket, refer to Socket for Onboard Diagnostics interface **238**
- Octane ratings, refer to Fuel specifications **221**
- Odometer **79**
- Oil, refer to Engine oil **234**
- Oil change intervals
 - refer to Service requirements **82**
- "On a new destination" in navigation **150**
- Onboard computer, refer to iDrive **16**
- "Onboard info" **81**
- Onboard toolkit **243**
- "On destination" **150**
- "On location" **150**
- Opening and closing
 - comfort access **40**
 - from inside **35**
 - from outside **32**
 - panorama glass sunroof **45**
 - using remote control **32**
 - using the door lock **34**
- Operating principle, iDrive **18**
- Operation by voice for mobile phone **205**
 - adjusting volume **206**
 - canceling **205**
 - commands **205**
 - correcting phone number **206**
 - dialing phone number **206**
 - placing a call **206**
 - redialing **207**
 - voice phone book **206**
- "Options" **213, 215**
- Orientation menu, refer to Start menu **18**
- Output, refer to Engine data **260**
- Outside air, refer to AUC Automatic recirculated-air control **117**
- Outside temperature display **79**
 - changing unit of measure **89**
 - in computer **89**
- Overview
 - operating principle **18**
 - radio control **168**
 - screen display **21**
- OP
P
Panic mode **33**
- Panorama glass sunroof **45**
 - moving manually **46**
- Park Distance Control PDC **90**
- "Parked car operation" **119**
- Parked car ventilation **118, 119**
 - activating activation time **119**
 - preselecting activation times **119**
 - switching on and off directly **119**
- Parked car ventilation system
 - LED **114**
- Parking, vehicle **63**
- Parking aid, refer to PDC Park Distance Control **90**

- Parking assistant, refer to PDC Park Distance Control **90**
- Parking brake, refer to Handbrake **64**
- Parking lamps **108**
– replacing bulbs **245**
- Partition net, Sports Wagon **128**
- Parts and accessories **6**
- Passenger-side exterior mirror, tilting down **55**
- "Pathway lighting" **109**
- Pathway lighting **109**
- "PDC" **91**
- "PDC display on" **91**
- PDC Park Distance Control **90**
- Personal Profile **31**
- "Perspective" **158**
- "Phone" **196, 198, 201**
- Phone book **200**
– changing entry **202**
– creating and editing voice phone book **206**
– deleting all entries **203**
– deleting entry **203**
– dialing phone number **202**
- Phone numbers
– deleting from phone book **203**
– dialing **201**
– most recent numbers **203**
– selecting in phone book **203**
– Top 8 **203**
- Pinch protection system
– glass sunroof, electric **44**
– panorama glass sunroof **46**
– power windows **43**
- Plasters, refer to First-aid kit **254**
- Plug-in unit for remote control, refer to Ignition lock **62**
- Polish **241**
- Pollen, refer to Microfilter/activated charcoal filter **118**
- Position, refer to Displaying current position **163**
- Position, refer to Storing current position **152**
- Power failure **251**
- Power windows, refer to Windows **42**
- Preselecting activation times of the parked car ventilation **119**
- "Presets" in radio mode **172, 180**
- Pressure, tires **222**
- Pressure monitoring of tires, refer to TPM Tire Pressure Monitor **97**
- "Profile" **216**
- Programmable buttons on steering wheel **56**
- Programmable memory buttons **22**
- Protective function, refer to Pinch protection system
– glass sunroof, electric **44**
– panorama glass sunroof **46**
– windows **43**
- ## R
- Radio
– autostore **174**
– controls **168**
– High Definition Radio **176**
– sampling stations **173**
– satellite radio **179**
– selecting frequency manually **173**
– selecting waveband **168, 172**
– station search **173**
– station selection **172**
– station with the best reception **174**
– storing stations **174**
– switching on/off **168**
– tone control **169**
– volume **169**
– weatherband, refer to Weather news flashes **176**
- Radio key, refer to Keys/remote control **30**
- Radio position, refer to Radio readiness **62**
- Radio readiness **62**
– switched off **63**
– switched on **62**
– with comfort access **41**
- Radio stations
– storing **174**
- Rain sensor **69**
- "Random", random play sequence **185**
- "Random all" in audio mode **186**
- "Random directory" in audio mode **186**
- "RDS" **175**
- Reading lamps **113**
- Rear armrest, refer to Center armrest, rear **127**
- Rear lamps, refer to Tail lamps **246**
– replacing bulbs **246**
- Rear seats
– adjusting head restraints **52**
– folding over backrest **127**
– heating **54**
– removing head restraints **52**
- Rear socket **127**
- Rear ventilation **118**
- Rearview mirror **54**
- Rear window
– changing wiper blade **243**
– heating **116**
– opening and closing on Sports Wagon **37**
– roller sun blind, refer to Sun blinds **122**
– wiper on Sports Wagon **70, 137**
- Rear window safety switch **43**
- "Received calls" **202**
- Reception
– quality **175**
– radio stations **175**
– regional station **174**
- Reception level of mobile phone, refer to Status information **21**

Recirculated-air mode **117**
– air recirculation **117**
– AUC Automatic recirculated-air control **117**
Reclining seat, refer to Seats **48**
Recording times, refer to Stopwatch **86**
Redialing with mobile phone **207**
"Redial" in mobile phone mode **202**
Reflectors, refer to Tail lamps **246**
Refueling **220**
Releasing
– hood **232**
Releasing the locks, refer to Unlocking **41**
"Relock door if not opened" **35**
Remaining distance, refer to Cruising range **80**
Remaining distance to destination, refer to Computer **81**
Remote control **30**
– comfort access **40**
– garage door opener **121**
– luggage compartment lid **33**
– malfunction **34, 42**
– replacing battery **42**
– tailgate **33**
Removing condensation on the windows **116**
"Repeat directory" in audio mode **185**
"Repeat" in audio mode **185**
"Repeat track" in audio mode **185**
Replacement fuses **251**
Replacement of tires, refer to Changing wheels **248**
Replacement remote control, refer to New remote controls **30**
Replacing bulbs, refer to Lamps and bulbs **243**
Replacing tires **230**

Replacing wheels/tires, refer to New wheels and tires **229**
Reporting safety defects **7**
Reserve
– warning, refer to Fuel gauge **80**
"Reset" **96, 98**
Reset, refer to Resetting tone settings **171**
"Reset" the stopwatch **87**
"resetting FTM ..." **96**
"Reset" tone settings **171**
Residual heat **117**
Restraint systems
– for children **58**
– refer to Safety belts **52**
Retaining straps, refer to Storage area package, Sports Wagon **129**
Retreaded tires **230**
Reverse, fast
– CD changer **186**
– CD player **186**
Reverse gear
– automatic transmission with Steptronic **65**
– manual transmission **64**
Road map **158**
"Roadside Assistance" **204, 210**
Roadside Assistance **254**
Roadside assistance **210**
Roadside parking lamps **110**
– replacing bulbs **245**
Roller blind
– refer to Roller sun blind **122**
Roller cover
– refer to Roll-up cover, Sports Wagon **128**
Roll-up cover, Sports Wagon **128**
Roof load capacity **263**
Roof-mounted luggage rack **139**
Rope, refer to Tow-starting and towing **255**
Rotary/pushbutton, refer to iDrive **16**

Route **154**
– bypassing sections **160**
– changing **160**
– changing criteria **154**
– displaying **157**
– displaying arrow display **157**
– displaying map view **158**
– displaying streets or towns/cities **159**
– selecting **154**
Route information, refer to Destination guidance with voice instructions **159**
Route map, refer to Displaying map view **158**
"Route preference", changing **154**
Route selection **154**
RSC Runflat System
Component, refer to Run-flat tires **229**
Run-flat tires **229**
– continuing driving with a damaged tire **96, 98**
– flat tire **96, 98**
– Flat Tire Monitor **95**
– new wheels and tires **229**
– tire inflation pressure **96, 98, 222**
– Tire Pressure Monitor **97**
– tire replacement **229, 230**
– winter tires **230**

S

Safety **5**
Safety belts **52**
– damage **53**
– sitting safely **47**
– warning lamp **52**
Safety belt tensioners
– refer to Airbags **100**
– refer to Safety belts **52**

- Safety systems
 - ABS Antilock Brake System [91](#)
 - airbags [100](#)
 - driving stability control systems [91](#)
 - safety belts [52](#)
- Safety tires, refer to Run-flat tires [229](#)
- Satellite radio
 - enabling channel [179](#)
 - selecting channel [180](#)
 - storing channel [180](#)
- satellite radio [179](#)
- "SAT" in radio mode [168](#), [179](#)
- "Save current destination" [154](#)
- "Scan"
 - music tracks on CD [184](#)
 - stations in radio mode [173](#)
- Scan
 - CD changer [184](#)
 - CD player [184](#)
 - radio [173](#)
- "Scan all" in audio mode [184](#)
- "Scan directory" in audio mode [184](#)
- Screen, refer to iDrive [16](#)
- Screw thread for tow fitting [256](#)
- SDARS, refer to Satellite radio [179](#)
- "Seat heater distribution" [53](#)
- Seats [48](#)
 - active backrest width adjustment [49](#)
 - adjusting the seats [48](#)
 - comfort seat [48](#)
 - easy entry/exit [49](#)
 - heating [53](#)
 - lumbar support [49](#)
 - memory, refer to Seat, mirror and steering wheel memory [49](#)
 - shoulder support [48](#)
 - sitting safely [47](#)
 - storing the setting [49](#)
 - thigh support [48](#)
 - ventilation, refer to Active seat ventilation [54](#)
- Securing load
 - refer to Securing cargo [138](#)
 - with ski bag, refer to Securing cargo [131](#)
- Select [109](#)
- "Select as destination" [150](#), [213](#)
- "Select current speed" [86](#)
- Selecting audio sources, refer to Operation via iDrive [168](#)
- Selecting distance with active cruise control [73](#)
- Selecting frequency manually [173](#)
- Selecting menu items [20](#)
- Selecting route [154](#)
- Selection options with navigation system [154](#)
- Selector lever
 - automatic transmission with Steptronic [64](#), [65](#)
- Selector lever lock, refer to Selecting transmission positions [65](#)
- self-leveling suspension [95](#)
- Service, refer to Roadside Assistance [254](#)
- Service and Warranty Information Booklet for US models [237](#)
- "Service Info" [82](#), [211](#), [234](#)
- Service Interval Display
 - refer to CBS Condition Based Service [237](#)
 - refer to Service requirements [82](#)
- "Service Request" [204](#), [211](#)
- "Service requirements" [82](#), [83](#), [211](#), [234](#)
- Service requirements
 - refer to CBS Condition Based Service [237](#)
- "Set date" [88](#)
- "Set" in audio mode [168](#)
- "Set" on trip computer [82](#)
- "Set service date" [83](#)
- "Set time" [88](#)
- Setting button, refer to Controls, controller [16](#)
- "Settings" [216](#)
- Settings
 - BMW Night Vision [105](#)
 - changing on Control Display [87](#)
 - clock, 12h/24h mode [88](#)
 - configuring, refer to Personal Profile [31](#)
 - date [88](#)
 - language [89](#)
 - units of measure [89](#)
- "Settings" in unlocking [32](#)
- Settings menu, refer to i menu [18](#)
- "Settings" with BMW Assist [214](#)
- Setting time, refer to Preselecting activation times [119](#)
- Shifting gears, Automatic transmission with Steptronic [65](#)
- Shift paddles on steering wheel [67](#)
- Short commands of voice command system [265](#)
- "Short route" in navigation [155](#)
- Short route in navigation, refer to Selecting route [154](#)

- Shoulder support **48**
- "Show current position" **150**
- "Show destination position" **150**
- Shuffled, refer to Random
 - CD changer **185**
 - CD player **185**
- Side airbags **100**
- Side marker lamps, replacing bulbs **246**
- Side-mounted turn signals, replacing bulbs **246**
- Side window blinds, refer to Sun blinds **122**
- Signal horn, refer to Horn **10**
- Sitting safely **47**
 - with airbags **47**
 - with head restraint **47**
 - with safety belts **47**
- Ski bag **130**
- Sliding/tilt sunroof
 - refer to Electric glass sunroof **43**
 - refer to Panorama glass sunroof **45**
- Slope assistant, refer to Starting assistant **94**
- Snap-in adapter
 - mounting/removing **207**
 - using **194**
- Snow chains **231**
- Socket for Onboard Diagnostics interface **238**
- Socket for remote control, refer to Ignition lock **62**
- Sockets, refer to Connecting electrical devices **126**
- Soft closure aid, refer to Automatic soft closing **35**
- Song search on CD, refer to Sampling tracks **184**
- SOS, refer to Initiating an emergency request **253**
- Sound distribution in audio mode
 - front/rear fader **170**
 - right/left balance **170**
- Spare
 - adapter for spare key **30**
 - fuses **251**
 - key **30**
 - wheel, refer to Compact wheel **250**
- Spare wheel, refer to Changing wheels **248**
- Special oils, refer to Approved engine oils **235**
- Specified oil grades, refer to Approved engine oils **235**
- Speed
 - limit **86**
 - with compact wheel **251**
- Speed-dependent volume **170**
- Speed limit warning, refer to Speed limit **86**
- Speedometer **12**
- "Speed volume", tone control **170**
- Speed with winter tires **230**
- Sport automatic transmission **67**
 - Dynamic Driving Control **67**
 - kick-down **65**
 - towing **256**
 - with comfort access **42**
- Sport program, Automatic transmission with Steptronic **65**
- Sports Wagon
 - automatic roll-up cover **128**
 - automatic tailgate operation **38**
 - compartments in cargo bay **129**
 - expanding cargo bay **128**
 - opening rear window **37**
 - opening tailgate **37**
 - panorama glass sunroof **45**
 - partition net **128**
 - rear window wiper **70**
 - rear window wiper, changing wiper blade **243**
 - releasing fuel filler door in event of electrical malfunction **220**
 - roll-up cover **128**
 - roll-up cover for cargo bay **128**
 - self-leveling suspension **95**
 - socket in cargo bay **126**
 - storage area package **129**
 - tail lamps, replacing bulbs **247**
- Stability control, refer to Driving stability control systems **91**
- Star button **56, 57**
- Start/Stop button **62**
 - starting the engine **63**
 - switching off the engine **63**
- "Start" for stopwatch **87**
- "Start guidance" **147, 156**
- Starting, refer to Starting engine **63**
- Starting assistance, refer to Jump starting **254**
- Starting assistant **94**
- Starting difficulties, refer to Jump starting **254**
- Starting off on slopes, refer to Starting assistant **94**
- Start menu, iDrive **18**
- "Start route guidance" **150**
- "Start service" **210**
- "Start service" with BMW Assist **213**

"State / Province" in destination entry [145](#)
 "State inspection" [83](#)
 Station, refer to Radio [172](#)
 "Status" [83](#)
 Status information on Control Display [21](#)
 Status of this Owner's Manual at time of printing [5](#)
 Steam cleaners [239](#), [240](#)
 Steering wheel
 – adjustment [56](#)
 – automatic adjustment, refer to Steering wheel memory [49](#)
 – buttons on steering wheel [11](#)
 – easy entry/exit [56](#)
 – heating [56](#)
 – lock, refer to Ignition lock [62](#)
 – memory [49](#)
 – programmable buttons [56](#)
 – shift paddles [67](#)
 Steering with variable ratio, refer to Active steering [99](#)
 Steptronic
 – refer to Automatic transmission with Steptronic [64](#)
 – refer to Sport automatic transmission [67](#)
 – refer to Sport program and manual mode [65](#)
 "Stop" for stopwatch [87](#)
 Stopwatch [86](#), [87](#)
 Storage area package, Sports Wagon [129](#)
 Storage compartments [124](#)
 "Store in address book" in navigation [152](#)
 "Store" in radio mode [175](#), [181](#)
 Storing [242](#)
 Storing current position [152](#)
 Storing radio stations [174](#)
 Storing sitting position, refer to Seat, mirror and steering wheel memory [49](#)
 Storing tires [230](#)

Storing your vehicle [242](#)
 "Street" in destination entry [146](#)
 Summer tires, refer to Wheels and tires [222](#)
 Sun blinds [122](#)
 "Surround Settings", tone control [170](#), [171](#)
 SW, waveband [172](#)
 Swinging up floor panel, Sports Wagon [129](#)
 Switches, refer to Cockpit [10](#)
 Switching automatically between high beams and low beams, refer to High-beam assistant [110](#)
 Switching off engine [63](#)
 Switching on
 – audio [168](#)
 – CD changer [168](#)
 – CD player [168](#)
 – radio [168](#)
 Switching on hour signal [88](#)
 Swiveling
 – headlamps, refer to Adaptive Head Light [110](#)
 Symbols [4](#)
 – indicator/warning lamps [13](#)
 – navigation system [162](#)
 – status information [21](#)
 – traffic information with navigation system [160](#)

T

Tachometer [79](#)
 Tailgate [36](#)
 – automatic operation [38](#)
 – emergency operation, refer to Opening manually [38](#)
 – locking and unlocking from inside [35](#)
 – opening from inside [37](#)
 Tail lamps [246](#)
 – replacing bulbs [246](#)
 Tank contents, refer to Capacities [264](#)
 Target cursor for navigation [149](#)

Technical alterations, refer to For your own safety [5](#)
 Technical data [260](#)
 – capacities [264](#)
 – dimensions [261](#)
 Telematics, refer to BMW Assist [209](#)
 Telephone
 – installation location, refer to Center armrest [123](#)
 – refer to Mobile phone [194](#)
 "Telephone list" [57](#)
 Temperature
 – adjusting in upper body region [115](#)
 – adjusting with automatic climate control [115](#)
 – changing units of measure [89](#)
 – refer to Coolant temperature [79](#)
 Temperature display
 – changing units of measure [89](#)
 – outside temperature [79](#)
 – outside temperature warning [79](#)
 Tempomat, refer to Cruise control [70](#)
 "Text language" [89](#)
 "Theater", tone control [171](#)
 The individual vehicle [5](#)
 Third brake lamp, refer to Center brake lamp [247](#)
 Through-loading system [127](#)
 Tightening torque of the lug bolts, refer to After mounting [250](#)
 Tilt alarm sensor [40](#)
 – switching off [40](#)
 Tilting down passenger-side exterior mirror [55](#)
 "Time" [88](#)
 "Time format" [88](#)
 Timer, refer to Preselecting activation times [119](#)
 "Timer 2" for parked-car ventilation [119](#)

"Timer 1" for parked-car ventilation **119**
Tire inflation pressures **222**
Tire pressure
– loss **96, 97**
Tire Pressure Monitor
TPM **97**
Tire Quality Grading **228**
Tire replacement
– new wheels and tires **229**
Tires
– age **228**
– air loss **96, 98**
– breaking-in **134**
– changing **229**
– condition **229**
– damage **229**
– flat tire, refer to Changing wheels **248**
– inflation pressure **222**
– new wheels and tires **229**
– pressure monitoring, refer to Flat Tire Monitor **95**
– pressure monitoring, refer to TPM Tire Pressure Monitor **97**
– replacing **248**
– retreaded tires **230**
– run-flat tires **229**
– size **227**
– tread **229**
– wear indicators **229**
– wheel/tire combination **229**
– winter tires **230**
Tire trouble
– changing wheels **248**
– compact wheel **250**
TMC station, refer to Traffic information **160**
"Tone" **169**
Tone dialing method **204**
Tone in audio mode
– adjusting **169**
– middle setting **171**
Tone on locking/unlocking **33**
Tools, refer to Onboard toolkit **243**
"Top 8" in mobile phone mode **202**

Torque
– refer to Engine data **260**
Torque, lug bolts, refer to After mounting **250**
Touch tone dialing, refer to Tone dialing method **204**
Tow bar **256**
Tow fitting **255**
Towing **255**
– methods **256**
– tow fittings **255**
– with automatic and sport automatic transmission **256**
– with manual transmission **256**
"Town / City" in destination entry **145**
Tow rope **257**
Tow-starting **255**
"TPM" **98**
TPM Tire Pressure Monitor **97**
– resetting system **97**
– system limits **97**
– warning lamp **98**
Tracks
– random sequence **185**
– sampling on CD **184**
– selecting with CD **183**
Traction-assist feature, refer to DSC Dynamic Stability Control **92**
Traction control, refer to DSC Dynamic Stability Control **92**
Traffic information for navigation
– depiction in route map **162**
– displaying **161**
– during destination guidance **163**
– symbols **162**
Traffic information with navigation **160**
"Traffic Info settings" **161**

Traffic jam
– displaying traffic information **160**
– refer to Bypassing route sections **160**
Transmission
– automatic transmission with Steptronic **64**
– manually unlocking and locking transmission lock **66**
– manual transmission **64**
– sport automatic transmission **67**
– starting assistant **94**
– towing **256**
Transporting children safely **58**
Transport securing device, refer to Securing cargo **138**
Tread depth, refer to Minimum tire tread **229**
Treble, refer to Tone control **169**
"Treble", tone control **169**
Trip computer **81, 82**
Trip-distance counter
– refer to Trip computer **81**
– refer to Trip meter **79**
"Triple turn signal" **68**
Trip meter **79**
– also refer to Trip computer **81**
Trip odometer, refer to Trip meter **79**
Trunk, refer to Cargo bay
Trunk lid, refer to Tailgate **37**
Turning circle, refer to Dimensions **261**
Turning lamps **110**
– replacing bulbs **246**
Turn signals **68**
– indicator lamp **12**
– replacing bulbs **246**

U

Uniform Tire Quality Grading/UTQR **228**
"Units" **89**

Units
 – average fuel consumption **89**
 – temperature **89**
 Universal garage-door opener, refer to Integrated universal remote control **121**
 Universal remote control **121**
 "Unlock button" **32**
 Unlocking
 – from inside **35**
 – from outside **32**
 – setting unlocking behavior **32**
 – without key, refer to Comfort access **40**
 Unlocking without key, refer to Comfort access **40**
 "Update services" **215**
 USB-audio interface/mobile phone audio interface **189**
 "USB" in audio mode **190**
 "Use current location as address" **152, 154**
 Used batteries
 – refer to Disposal **251**
 – refer to Replacing battery **42**
 Using turn signals **68**

V

Valve screw caps, refer to After mounting **250**
 Vehicle
 – battery **251**
 – breaking-in **134**
 – loading **137**
 – measurements, refer to Dimensions **261**
 – parking **63**
 – weights **263**
 "Vehicle / Tires" in unblocking **32**
 Vehicle care, refer to Care **239**
 Vehicle jack **249**
 – jacking points **250**

Vehicle position, refer to Displaying current position **163**
 Ventilation **118**
 – draft-free **118**
 – in rear **118**
 – while stationary **118**
 Venting, refer to Ventilation **118**
 Vent outlets **114**
 – refer to Ventilation **118**
 Vent outlets of automatic climate control **114**
 Vents, refer to Ventilation **118**
 "Vent settings" **116**
 Viscosity **235**
 Voice, refer to Destination guidance with voice instructions **159**
 Voice command system
 – overview **24**
 – short commands **265**
 Voice instructions for navigation system **159**
 – muting **57**
 – repeating **57, 160**
 – switching on/off **57, 159**
 – volume **160**
 Voice phone book **206**
 Volume **168**
 – audio sources **168**
 – cargo bay **263**
 – fuel tank, refer to Capacities **264**
 – mobile phone **200**
 – setting speed-dependent **170**
 – voice instructions **160**
 – windshield cleaning system, refer to Capacities **264**

W

Warning lamps, refer to Indicator and warning lamps **13**
 Warning messages, refer to Check Control **84**

Warning on leaving lane, refer to Leaving lane warning **106**
 Warning triangle **253**
 Warranty and Service Guide Booklet for Canadian models **237**
 Washer fluid **70**
 – capacity of the reservoir **70**
 Waste container, refer to Ashtray **125**
 Water on roads, refer to Driving through water **136**
 Water penetration **239, 240**
 Waveband for radio **172**
 "WB" **168, 176**
 Wear indicators in tires, refer to Minimum tread depth **229**
 Weather news flashes **176**
 Website BMW **4**
 Weights **263**
 Welcome lamps **108**
 "Welcome light" **109**
 Wheel/tire combination, refer to New wheels and tires **229**
 Wheel/tire damage **229**
 Wheelbase, refer to Dimensions **261**
 Wheels and tires **222**
 Width, refer to Dimensions **261**
 Windows **42**
 – convenient operation **33**
 – convenient operation from outside **34**
 – convenient operation with comfort access **41**
 – rear window, Sports Wagon **37**
 – safety switch **43**
 Windshield
 – cleaning, refer to Wiper system **69**
 – defrosting, refer to Defrosting windows **116**
 – displays, refer to Head-Up Display **102**

Windshield wash

- automatic, refer to Rain sensor [69](#)
- capacities, reservoir [264](#)
- filler neck for washer fluid [233](#)
- rear window [70](#)
- washer fluid [70](#)
- windshield washer nozzles [70](#)
- wiper system [69](#)

Windshield wipers, refer to

- Wiper system [69](#)
- wiper blade replacement [243](#)

Winter tires [230](#)

- setting speed limit [86](#)
- storage [230](#)

Wiper blades

- replacement [243](#)

Wiper system [69](#)

- rain sensor [69](#)
- washer fluid [70](#)
- windshield washer nozzles [70](#)

"With highways" in navigation [155](#)

Word matching principle for navigation [155](#)

Working in the engine compartment [232](#)

Wrenches/screwdrivers, refer to Onboard toolkit [243](#)

Z

"Zoom" with BMW Night Vision [106](#)

X

xDrive [93](#)

Xenon lamps [245](#)

- replacing bulbs [245](#)

Y

Your individual vehicle

- programmable buttons on steering wheel [56](#)
- settings, refer to Personal Profile [31](#)

امداد خودرو فارما

تلفن شبانه روزی: ۰۲۱-۸۸۸۶۲۰۸۵

FarmaSOS.com

امداد خودرو فارما

تلفن شبانه روزی: ۰۲۱-۸۸۸۶۲۰۸۵

FarmaSOS.com

امداد خودرو فارما

تلفن شبانه روزی: ۰۲۱-۸۸۸۶۲۰۸۵

FarmaSOS.com

More about BMW



The Ultimate
Driving Machine

bmwusa.com

امداد خودرو فارما

تلفن شبانه روزی: ۰۲۱-۸۸۸۶۲۰۸۵

FarmaSOS.com

01 41 2 600 721 ue

