



امداد خودرو فارما

FarmaSOS.com



# امداد خودرو فارما

تلفن شبانه روزی: ۰۲۱-۸۸۸۶۲۰۸۵

**FarmaSOS.com**

**X3 2.5i**  
**X3 3.0i**

We are very glad that you have decided to purchase a BMW.

The more familiar you are with it, the more secure you will be on the roads. This is why we ask you:

Please read the information we have gathered for you in this owner's manual before you set off with your new BMW. You receive important information on vehicle operation that enables you to make full use of the technical benefits of your BMW. You will also find information on maintenance that serves to retain the operating and road safety as well as the best possible value retention of your vehicle. You will find supplementary information in other brochures.

This Owner's Manual should be considered a permanent part of this vehicle. It should stay with the vehicle when sold to provide the next owner with important operating, safety and maintenance information.

We wish you good and safe driving.

BMW AG

امداد خودرو فارما

تلفن شبانه روزی: ۰۲۱-۸۸۸۶۲۰۸۵

[FarmaSOS.com](http://FarmaSOS.com)

# امداد خودرو فارما

تلفن شبانه روزی: ۰۲۱-۸۸۸۶۲۰۸۵

[FarmaSOS.com](http://FarmaSOS.com)

© 2003 Bayerische Motoren Werke  
Aktiengesellschaft  
Munich, Germany  
Reprints, including excerpts, only with the  
written consent of BMW AG, Munich.  
Order No. 01 41 0 157 631  
US English VIII/03  
Printed in Germany  
Printed on environmentally friendly paper,  
bleached without chlorine, suitable for recycling.

# Contents

The fastest way to find specific topics is to use the index, refer to page 119.

## Using this Owner's Manual

4 Notes

## At a glance

10 Cockpit

## Controls

18 Opening and closing

27 Adjustments

34 Transporting children safely

37 Driving

45 Everything under control

49 Technology for comfort, convenience and safety

57 Lamps

60 A congenial climate

66 Practical interior accessories

## Driving tips

76 Things to remember when driving

## Mobility

84 Refueling

86 Wheels and tires

92 Under the engine hood

97 Maintenance

98 Laws and regulations

99 Replacing components

107 Giving and receiving assistance

## Reference

114 Technical data

117 Everything from A to Z

امداد خودرو فارما

تلفن شبانه روزی: ۰۲۱-۸۸۸۶۲۰۸۵

PharmaSOS.com

# Notes

## Using this Owner's Manual

We have made every effort to ensure that you are able to find what you need in this Owner's Manual as quickly as possible. The fastest way to find certain topics is by using the detailed index at the end. For a brief initial overview, please refer to the first chapter.

Should you sell your BMW some day, please remember to hand over the Owner's Manual as well; it is an important component of your vehicle.

### Additional sources of information

If you have additional questions, your BMW Sports Activity Vehicle Center is always happy to advise you.

You can find information on BMW, e.g. technology, on the Internet at [www.bmwusa.com](http://www.bmwusa.com).

## Symbols used



Indicates precautions that must be followed precisely in order to avoid the possibility of personal injury and serious damage to the vehicle.



Contains information that will assist you in gaining the optimum benefit from your vehicle and enable you to care more effectively for your vehicle.



Refers to measures that can be taken to help protect the environment.

◀ Marks the end of a specific item of information.

\* Indicates special equipment, country-specific equipment and optional extras when available.



Vehicle Memory, Key Memory, refer to page 33. Identifies functions that can be specifically adapted for a particular key or vehicle. These adjustments can be performed either by yourself or by your BMW Sports Activity Vehicle Center.

### Symbols on vehicle components



Indicates that you should consult the relevant section of this Owner's Manual for information on a particular part or assembly.

## The individual vehicle

On buying your BMW, you have decided in favor of a model with individualized equipment and features. This Owner's Manual describes all models and equipment that BMW offers within the same group.

We hope you will understand that equipment and features are included that you might not have chosen for your vehicle. Sections describing options and special equipment are marked by asterisks \* to assist you in identifying possible differences between the descriptions in this manual and your own vehicle's equipment.

Should your BMW be equipped with features or accessories not described in this manual, e.g. car radio or portable phone, please consult the enclosed supplementary owner's manuals.

## Editorial notice

BMW pursues a policy of continuous, ongoing development that is conceived to ensure that our vehicles continue to embody the highest quality and safety standards combined with advanced, state-of-the-art technology. For this reason, the features described in this Owner's Manual may differ from those on your vehicle. Nor can errors and omissions be entirely ruled out. You are therefore asked to appreciate that no claims can be entertained on the basis of the data, illustrations or descriptions in this Owner's Manual.

امداد خودرو فارما

تلفن شبانه روزی: ۰۸۵-۸۸۸۶۲-۰۲۱

FarmaSOS.com

## For your own safety

### Fuels

 Use unleaded gasoline only. Fuels containing up to and including 10% ethanol or other oxygenates with up to 2.8% oxygen by weight, i.e. 15% MTBE or 3% methanol plus an equivalent amount of co-solvent – will not void the applicable warranties respecting defects in materials or workmanship. Field experience has indicated significant differences in fuel quality – i.e. volatility, composition, additives, etc. – among gasolines offered for sale in the United States and Canada. The use of poor-quality fuels may result in driveability, starting and stalling problems especially under certain environmental conditions, such as high ambient temperature and high altitude.

Should you encounter driveability problems which you suspect could be related to the fuel you are using, we recommend that you respond by switching to a recognized high-quality brand.

Failure to comply with these recommendations may result in unscheduled maintenance.

Follow the relevant safety rules when you are handling gasoline. ◀

### Maintenance and repair

 Advanced technology, e.g. the use of modern materials and high-performance electronics, requires specially adapted maintenance and repair methods. Therefore, only have corresponding work on your BMW carried out by a BMW Sports Activity Vehicle Center or a workshop that works according to BMW repair procedures with correspondingly trained personnel. If work is carried out improperly, there is a danger of consequential damage and the related safety risks. ◀

## Parts and accessories

 For your own safety, use genuine parts and accessories approved by BMW.

When you purchase accessories tested and approved by BMW and Genuine BMW Parts, you simultaneously acquire the assurance that they have been thoroughly tested by BMW to ensure optimum performance when installed on your vehicle. BMW warrants these parts to be free from defects in material and workmanship. BMW will not accept any liability for damages resulting from installation of parts and accessories not approved by BMW. BMW cannot test every product made by other manufacturers to verify if it can be used on a BMW safely and without risk to either the vehicle, its operation, or its occupants.

Genuine BMW Parts, BMW Accessories and other products approved by BMW, together with professional advice on using these items, are available from all BMW Sports Activity Vehicle Centers.

Installation and operation of non-BMW approved accessories such as alarms, radios, amplifiers, radar detectors, wheels, suspension components, brake dust shields, telephones – including operation of any portable phone from within the vehicle without using an externally mounted antenna – or transceiver equipment, for instance, CBs, walkie-talkie, ham radio or similar accessories, may cause extensive damage to the vehicle, compromise its safety, interfere with the vehicle's electrical system or affect the validity of the BMW Limited Warranty. See your BMW Sports Activity Vehicle Center for additional information. ◀

 Maintenance, replacement, or repair of the emission control devices and systems may be performed by any automotive repair establishment or individual using any certified automotive part. ◀



## Service and warranty

This manual is supplemented by a Service and Warranty Information Booklet for US models or a Warranty and Service Guide Booklet for Canadian models.

We recommend that you read this publication thoroughly.

Your BMW is covered by the following warranties:

- ▷ New Vehicle Limited Warranty
- ▷ Rust Perforation Limited Warranty
- ▷ Federal Emissions System Defect Warranty
- ▷ Federal Emissions Performance Warranty
- ▷ California Emission Control System Limited Warranty.

Detailed information about these warranties is listed in the Service and Warranty Information Booklet for US models or in the Warranty and Service Guide Booklet for Canadian models.

## Reporting safety defects

The following only applies to vehicles owned and operated in the US.

If you believe that your vehicle has a defect which could cause a crash or could cause injury or death, you should immediately inform the National Highway Traffic Safety Administration NHTSA in addition to notifying BMW of North America, LLC, P.O. Box 1227, Westwood, New Jersey 07675-1227, telephone toll-free 1-800-831-1117.

If NHTSA receives similar complaints, it may open an investigation, and if it finds that a safety defect exists in a group of vehicles, it may order a recall and remedy campaign. However, NHTSA cannot become involved in individual problems between you, your dealer, or BMW of North America, LLC.

To contact NHTSA, you may either call the Auto Safety Hotline toll-free at 1-800-424-9393 or 366-0123 in Washington, D.C. area, or write to: NHTSA, U.S. Department of Transportation, Washington, D.C. 20590. You can also obtain other information about motor vehicle safety from the Hotline.

FarmaSOS.com



# امداد خودرو فارما

تلفن شبانه روزی: ۰۲۱-۸۸۸۶۲۰۸۵

[FarmaSOS.com](http://FarmaSOS.com)



## At a glance

This overview of buttons, switches and displays is intended to serve as a source of orientation in your vehicle's operating environment. The section will also assist you in becoming acquainted with the control concepts and options available for operating the various systems.

تلفن شبانه روزی: ۰۲۱-۸۸۸۶۲۰۸۵

FarmaSOS.com

# Cockpit

## Controls

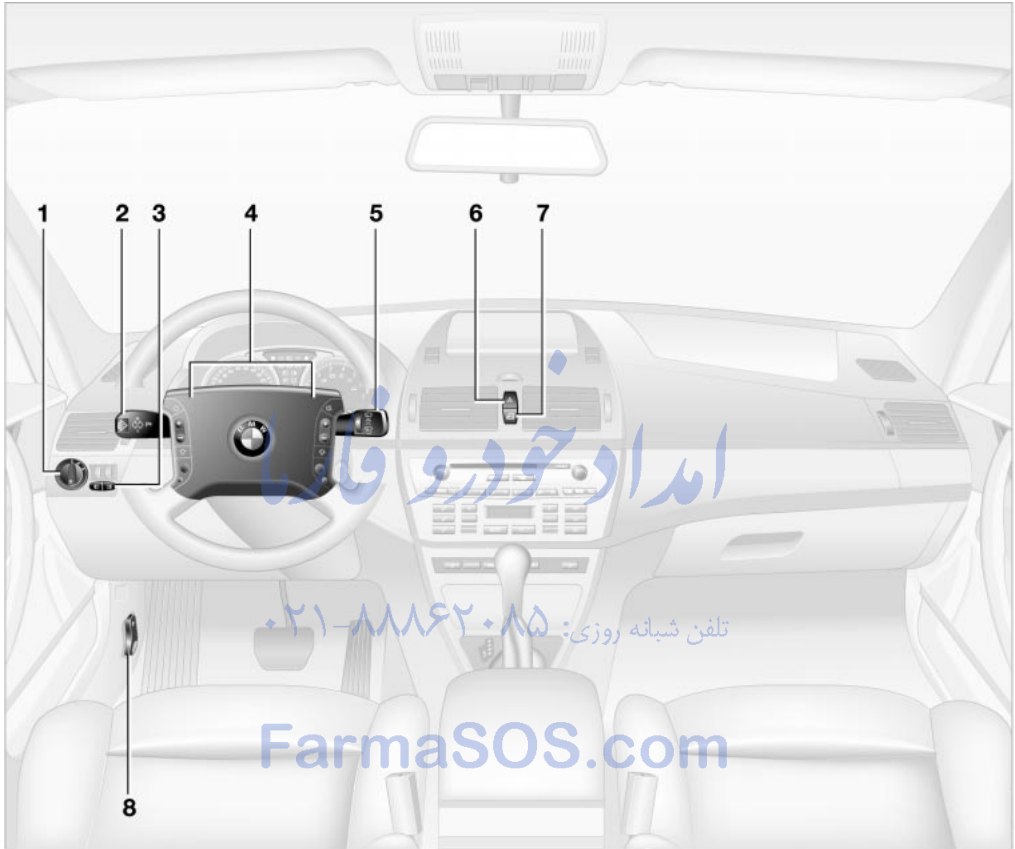

- |   |                          |    |   |                                 |
|---|--------------------------|----|---|---------------------------------|
| 1 | Parking lamps/low beams  | 57 | 4 | Horn                            |
| 2 | ▷ Turn signal indicators | 41 | 5 | Washer/Wiper system/Rain sensor |
|   | ▷ Standing lamps         | 58 | 6 | Hazard warning flashers         |
|   | ▷ High beams             | 58 | 7 | Central locking system          |
|   | ▷ Headlamp flasher       | 41 | 8 | Unlocking the engine hood       |
|   | ▷ Computer               | 47 |   |                                 |
| 3 | Fog lamps                | 58 |   |                                 |

# Instrument cluster

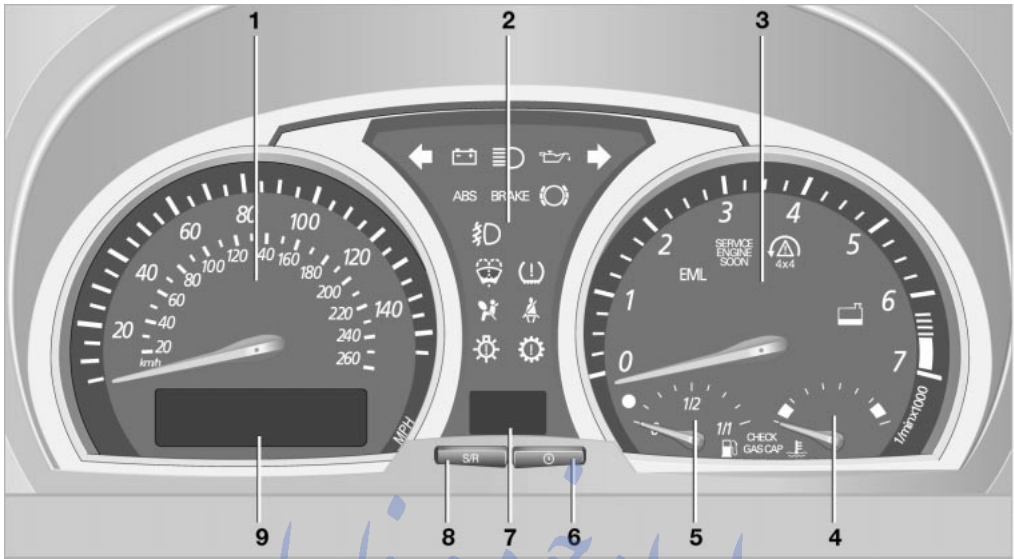

- 1 Speedometer
- 2 Indicator and warning lamps 12
- 3 Tachometer 45  
with indicator and warning lamps 12
- 4 Coolant temperature gauge 45
- 5 Fuel gauge 45
- 6 Button for
  - ▷ Displaying the time 46
  - ▷ Service Interval Display 46
- 7 Selector lever and program display for automatic transmission 40
- 8 Button for
  - ▷ Resetting trip odometer 45
  - ▷ Setting the time 46
- 9 Display for
  - ▷ Trip odometer/odometer 45
  - ▷ Time 46
  - ▷ Service Interval 46
  - ▷ Computer 47

## Indicator and warning lamps

### Technology that monitors itself

The indicator and warning lamps identified by the ● symbol are subjected to an operation check each time you switch on the engine. They each light up once for different periods of time.

When a malfunction occurs in a monitored system, the corresponding lamp will either fail to go out when the engine is started, or it will come on again during normal driving. Detailed information is provided on the specified pages.



Please fasten safety belt ● 30



Airbags ● 54



Brake system ●  
With handbrake released 52/ 96  
With handbrake set 38  
With other warning lamps 52



Brake warning lamp for Canadian models



Driving stability control systems/  
Antilock Brake System ● 53



Antilock Brake System ABS/  
Chassis control system for Canadian models



Brake pads ● 96



Dynamic Stability Control DSC/  
xDrive ● 50/ 52



Flat Tire Monitor ● 53



Automatic transmission ● 39



Engine oil ● 94



Service Engine Soon ● 98



Service Engine Soon ● 37  
warning lamp for Canadian models.



Check Gas Cap ●



Engine electronics ● 37



Battery charge current ● 105



Topping up coolant 95



Topping up washer fluid 94



Lamp defective 57



Turn signal indicators 41



Fog lamps 58



Headlamp flasher 41  
High beams 58



Cruise control 43

## Colors

The indicator and warning lamps can light up in different colors and combinations.

The following section explains the significance of the individual colors as well as how you should respond when they appear.

- ▷ Red:  
Stop the vehicle immediately  
or  
an important reminder
- ▷ Yellow:  
Have the system inspected as soon as possible  
or  
for your information
- ▷ Green:  
For your information
- ▷ Blue  
For your information.

امداد خودرو فارما

تلفن شبانه روزی: ۰۸۵-۸۸۸۶۲-۰۲۱

FarmaSOS.com

## Buttons in steering wheel\*

The buttons integrated in the steering wheel are provided so that you can operate a number of accessories quickly and without being distracted from traffic conditions. You may operate:

- ▷ selected audio source functions
- ▷ Recirculating air mode/steering wheel heating\*
- ▷ the cruise control
- ▷ some telephone functions
- ▷ the voice command system.



In order to operate a system, the corresponding system must be switched on. ◀

### Telephone/voice command system



Press briefly:

Accept incoming call, start dialing, terminate call.

Extended pressure:

Switch voice command system on and off

### Telephone/audio sources

R/T

Switching between telephone and radio, cassette, CD or MD

### Fast forward/reverse



- ▷ Radio  
Press briefly: next station
- ▷ CD  
Press briefly: skipping tracks  
Maintain pressure on the button: fast forward/reverse
- ▷ Telephone  
Browse name directory

### Volume



### Cruise control



Cruise control: calling up



Cruise control: storing and accelerating + as well as braking and storing -

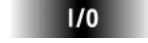

Cruise control: activate/interrupt/deactivate

### Recirculated-air mode/steering wheel heating



Depending on the equipment, there is a button for the recirculated-air mode or steering wheel heating. ◀



Switching the recirculated-air mode and automatic recirculated-air control on and off



Steering wheel heating: switching on/off, refer to page 31



# امداد خودرو فارما

تلفن شبانه روزی: ۰۲۱-۸۸۸۶۲۰۸۵

**FarmaSOS.com**



# امداد خودرو فارما

تلفن شبانه روزی: ۰۲۱-۸۸۸۶۲۰۸۵

[FarmaSOS.com](http://FarmaSOS.com)

## Controls

This chapter is intended to provide you with information for complete control of your vehicle. Its extensive array of features and accessories, both for driving and for your own safety, comfort and convenience, are described here.

تلفن شبانه روزی: ۰۲۱-۸۸۸۶۲۰۸۵

FarmaSOS.com

# Opening and closing

## Key set

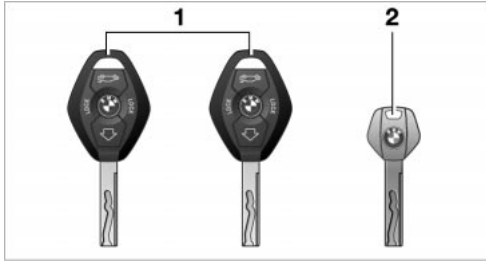

- 1 Master keys with remote control determine the functions of the Key Memory, refer to page 33.

You can mark the keys using the colored decals you received on taking delivery of the vehicle

 There is an extended-life battery in every master key which is charged automatically in the ignition lock as you drive.

If you have any master keys that are not being used on a regular basis, you should therefore remember to recharge these units by using them to drive the vehicle for an extended period at least once a year. ◀

- 2 Spare key for storage in a safe place, such as in your wallet.  
This key cannot be used to open the lock for the glove compartment. This is an advantage, e.g. at a hotel. The key is not intended for constant use.

## Central locking system

### The concept

The central locking system is ready for operation whenever the driver's door is closed. The system engages or releases the locks on the

- ▷ doors
- ▷ tailgate

- ▷ fuel filler door.

The central locking system can be operated from the outside

- ▷ via the remote control
- ▷ via the driver's door lock

and from inside via the button for the central locking system.

When the system is locked from inside, the fuel filler door remains unlocked, refer to page 20.

The anti-theft system is automatically activated whenever you activate the central locking system from outside the vehicle. This prevents the doors from being unlocked via the safety lock buttons or door handles. The alarm system is also armed or disarmed.

In an accident, the central locking system automatically unlocks the vehicle. In addition, the hazard warning flashers and interior lamps switch on.

 You can have an acknowledgment signal set to confirm that the vehicle is correctly locked. ◀

## Opening and closing – from outside

### Using the remote control

The remote control provides two additional functions for the central locking system:

- ▷ Switching on the interior lamps, refer to page 19.  
You can also use this function to locate your vehicle in parking garages etc.
- ▷ Opening the tailgate, refer to page 19.  
The tailgate will open slightly, regardless of whether it was previously locked or unlocked.

In addition, the remote control offers you another function:

- ▷ **Panic mode**  
In case of danger, you can trigger an alarm.

When you engage/release the vehicle locks, you simultaneously activate/deactivate the anti-theft system, arm/disarm the alarm system, and switch the interior lamps on/off.



As a reminder that the ignition key is still in the ignition lock after you open the driver's door, you can have a sound signal set. ◀



Protect the remote control against unauthorized use by handing over only the spare key, for example when using hotel valet parking. ◀



Because any persons or animals left unattended in a parked vehicle could lock the doors from the inside, you should always take the vehicle's keys with you so that the vehicle can be opened again from the outside at any time. ◀

## Unlocking

Press the  button.

Press the button once to unlock the driver's door only; press a second time to unlock all remaining doors as well as the tailgate and the fuel filler door.

## Convenience opening mode

Press and hold the  button. The windows and the sliding panel of the panorama glass roof are opened.

Press the  button a second time and hold. The panorama glass roof is opened.



If you desire, you can have this special feature activated/deactivated on a vehicle-specific basis. ◀

## Locking and securing

Press the  LOCK button.



If you desire, the vehicle locks automatically if no door or lid is opened after unlocking. You may have this function set on a vehicle-specific basis if you wish. ◀

## Switching off the tilt alarm sensor\* and interior motion sensor\*

Press the  LOCK button once again directly after locking.  
For details, refer to page 25.

## Switching on the interior lamps

If the vehicle is locked, press the  LOCK button.

## Panic mode\*

By pressing and holding the  button for more than approx. two seconds, you can trigger the alarm system in response to any impending danger.

To switch off the alarm: press any of the buttons.

## Unlocking tailgate

Press the  button.

The tailgate will open slightly, regardless of whether it was previously locked or unlocked.



Before and after a trip, ensure that the tailgate has not been opened unintentionally.

A previously locked tailgate is also locked after closing. ◀



If you desire, the tailgate can only be opened using the remote control if the vehicle is unlocked. This can be adjusted. ◀

## Malfunctions

The remote control system may be affected by other units or equipment operating in the immediate vicinity of your vehicle. Should the remote control fail to operate owing to interference of this kind, you can respond by using the master key to unlock your vehicle at one of the doors.

In case of faults, please contact your BMW Sports Activity Vehicle Center. You can also obtain replacement keys there.

If it is no longer possible to lock the vehicle via the remote control, the battery is discharged. Use this remote control during an extended drive; this will recharge the battery, refer to page 18.

### For US owners only

The transmitter and receiver units comply with part 15 of the FCC – Federal Communications Commission – regulations. Operation is governed by the following:

FCC ID: LX8EWS  
LX8FZVS  
LX8FZVE

Compliance statement:

This device complies with part 15 of the FCC Rules. Operation is subject to the following two conditions:

- ▷ This device may not cause harmful interference, and
- ▷ this device must accept any interference received, including interference that may cause undesired operation.

▷ Any unauthorized modifications or changes to these devices could void the user's authority to operate the equipment. ◀

### Using the door lock

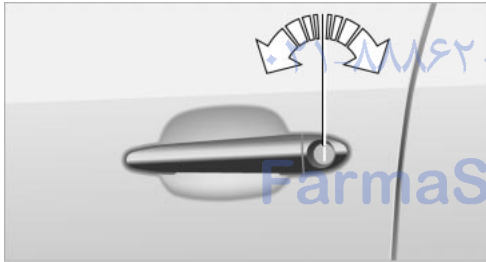

One turn of the key in the driver's door lock unlocks the driver's door only.

Turning the key a second time unlocks all of the remaining doors, the tailgate and the fuel filler door.



You can have a signal set to confirm that the vehicle's locks have engaged securely. ◀

### Convenience operation

You also have the option of operating the windows and the panorama glass roof from the driver's door lock.

- ▷ To open:  
With the door closed, turn the key to the Unlock position and hold it there.
- ▷ To close:  
With the door closed, turn the key to the Lock position and hold it there.



Watch during the closing process to be sure that no one is injured. Releasing the key stops the operation. ◀

### Manual operation

In the event of an electrical defect: You can turn the key all the way to the right or left in the door lock to lock or unlock the driver's door.

### Opening and closing – from inside



You can use this button to operate the central locking system when the front doors are closed. With this button, only the doors and the tailgate are unlocked or locked. The anti-theft system is not activated.



If only the driver's door was unlocked from the outside and you press the button, then, with the driver's door still open, the passenger-side door, the tailgate and the fuel filler door will also unlock. If the driver's door is closed, it will be locked. ◀



The central locking system locks automatically after driving off. This can be adjusted to be vehicle-specific or key-specific. ◀

## Unlocking and opening the doors

1. Press the button for central locking system
2. Pull the respective door handle above the armrest

or

individually pull on the door handle of each door twice to unlock and open.

## Engaging the locks

- ▷ Press button for central locking system or
- ▷ press down the individual safety lock buttons.

 To prevent you from being locked out, the opened driver's door cannot be locked using the safety lock button. ◀

 Because any persons or animals left unattended in a parked vehicle could lock the doors from the inside, you should always take the vehicle's keys with you so that the vehicle can be opened again from the outside at any time. ◀

## Tailgate

### Opening from outside

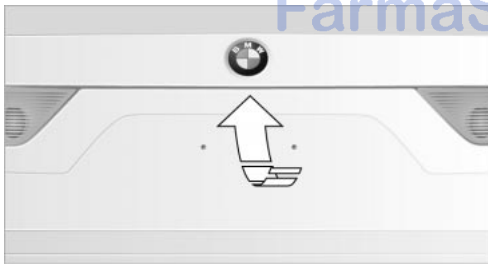

Press the button in the handle strip. The tailgate is unlocked and opens somewhat.

 During opening, the tailgate pivots upward and to the rear. Ensure that adequate clearance is available before opening. ◀

When the tailgate is open, the cargo area and interior are lit up.

## Manual unlocking

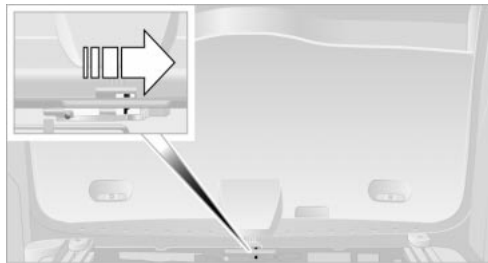

In the event of an electrical defect:

1. Fold up the floor cover in the cargo area
2. Press the lever to the right.

The tailgate is locked again as soon as you close it.

## Closing



The handle recesses on the interior trim of the tailgate make it easier to pull down.

 To avoid injuries, be sure that the travel path of the tailgate is clear when it is closed, as with all closing procedures. ◀

 Operate the vehicle only when the tailgate is completely closed. Otherwise, exhaust fumes could penetrate the interior of the vehicle. ◀

If special circumstances should make it absolutely necessary to operate the vehicle with the tailgate open:

1. Close all windows and the glass roof
2. Greatly increase the air supply of the air conditioner or automatic climate control, refer to page 60 or 63.



## Electric power windows

### Opening and closing windows



As of ignition key position 1:

- ▷ Press the switch up to the resistance point:  
The window continues to move as long as you continue to press the switch
- ▷ Press the switch beyond the resistance point:  
The window moves downward automatically. Briefly press the switch again to stop the opening movement.

You can close the windows in the same manner by pulling the switch.

### After switching off the ignition

You can operate the electric power windows for up to 15 minutes as long as neither of the front doors has been opened.

 When leaving the vehicle parked, always remove the remote control from the ignition lock and close the doors; this precaution prevents children from operating the electric power windows and injuring themselves, etc. ◀

For convenience operation with the door lock, refer to page 20.

### Anti-trapping mechanism

If the closing force rises beyond a pre-defined threshold during closing, the system will immediately stop moving the window prior to lowering it slightly.

 Despite the anti-trapping mechanism you should always inspect the window's travel path prior to closing it, as the safety system might fail to detect certain

kinds of obstructions, such as very thin objects, and the window would continue closing.

You can disable the anti-trapping mechanism by pressing the switch beyond the resistance point and holding it. ◀

### Following interruptions in electrical power supply

After disconnecting the battery, the anti-trapping mechanism must be reinitialized. To do this, open and close the windows once and continue pull the switch for 2 seconds after closing.

### Safety switch



With the safety switch, you can prevent the rear windows from being opened or closed via the switches in the rear passenger area, by children, for example. The indicator lamp lights up when this safety feature is activated.

 Press the safety switch whenever children are riding in the rear of the vehicle. Careless use of the electric power windows can lead to injury. ◀

 You can deactivate the function again as of ignition key position 1. ◀

### Accessories in the window area

After installing any accessory – such as a clamp-on antenna for a portable phone – within the window's travel range, you will need to have the system reinitialized for use under the new conditions. Please contact your BMW Sports Activity Vehicle Center.



## Panorama glass roof\*

 To prevent injuries, exercise care when closing the panorama glass roof and keep it in your field of vision until it is shut.

When leaving the vehicle, always remove the remote control and close the doors to prevent children from operating the glass roof and injuring themselves, etc. ◀

### Raising, opening, closing

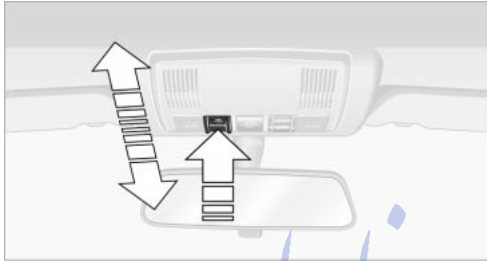

The glass roof and sliding panel are operational as of ignition key position 1.

After the ignition has been switched off: You can operate the panorama glass roof for up to 1 minute as long as neither of the doors has been opened.

### Opening the glass roof and sliding panel together

Within 2 seconds, push the switch backward twice beyond the resistance point. The glass roof moves to the convenience position and the sliding panel opens completely. To open the glass roof fully at a standstill, slide the switch backward beyond the resistance point.

Sliding the switch again stops the motion.

### Closing the glass roof and sliding panel together

Within 2 seconds, push the switch forward twice beyond the resistance point. The glass roof and sliding panel close completely.

Sliding the switch again stops the motion.

### Operating sliding panel

- ▷ Opening, closing: Slide the switch up to the resistance point in the desired direction. The motion continues for as long as the switch is held
- ▷ Automatic opening, closing: Slide the switch beyond the resistance point in the desired direction. Sliding the switch again stops the motion.

### Operating glass roof

- ▷ Opening, closing: Slide the switch up to the resistance point in the desired direction. The motion continues for as long as the switch is held
- ▷ Automatically in convenience position: Slide the switch beyond the resistance point in the desired direction. In the convenience position, the glass roof is not fully opened. Sliding the switch again stops the motion.
- ▷ Automatic opening and closing: Slide the switch beyond the resistance point in the desired direction. The glass roof moves initially into the convenience position. To open or close fully at a standstill, slide the switch beyond the resistance point in the desired direction. Sliding the switch again stops the motion
- ▷ To raise: slide switch  
To lower: slide switch forward. Sliding the switch again stops the motion.

### Ventilation setting

In the ventilation setting, the glass roof is raised and the sliding panel opens to a gap: Press the switch twice within 2 seconds.

Pressing the switch again stops the motion.



If the glass roof and sliding panel are closed:

Press the switch once. ◀

### Anti-trapping mechanism

If the glass roof and sliding panel encounter resistance when closing from roughly one third of the roof opening or when closing from the raised position, the closing action is interrupted and the glass roof and sliding panel reopen a little.



Despite the anti-trapping mechanism you should always inspect the roof's travel path prior to closing it, as the safety system might fail to detect certain kinds of obstructions, such as very thin objects, and the window would continue closing.

The anti-trapping mechanism for closing the panorama glass roof is deactivated if the switch is pressed beyond the resistance point and held there. The closing action is interrupted when you release the switch. ◀

### Following interruptions in electrical power supply

Following interruptions in electrical power, for instance, when the battery is disconnected, it is possible that the glass roof will extend to its tilt-up position, but fail to respond to other commands. For initialization, please contact your BMW Sports Activity Vehicle Center.

### Manual operation

In the event of an electrical malfunction, you can operate the glass roof manually:

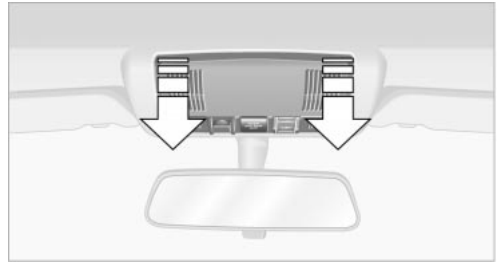

M1V02531CMA

1. Pull the cover downward

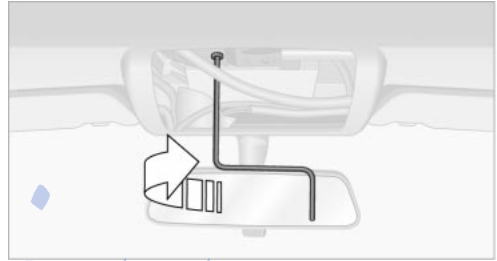

M1V02546CMA

2. Insert the Allen key from the compartment beneath the cargo area floor, refer to page 103, in the proper opening and turn the panorama glass roof in the desired direction. Direction of rotation for closing, refer to arrow.

## Alarm system\*

### The concept

The vehicle alarm system responds:

- ▷ When a door, the hood, or the tailgate is opened
- ▷ To movement in the vehicle's interior – interior motion sensor
- ▷ To variations in the vehicle tilt angle such as occur during attempts to steal the wheels or tow the vehicle
- ▷ To interruption of battery voltage.

The system responds to unauthorized vehicle entry and attempted theft by simultaneously activating:

- ▷ An acoustic alarm, which lasts for a period of approx. 30 seconds
- ▷ The hazard warning flashers for approx. 5 minutes

- ▷ The high beams, which flash on and off in the same rhythm.

## Arming and disarming the alarm system

When the vehicle is locked or unlocked with the key or the remote control, the alarm system is also simultaneously armed or disarmed.

If the alarm system has been properly armed, the hazard warning flashers light up once.



You can have different acknowledgment signals set to confirm arming and disarming. ◀

You can also open the tailgate with the system armed using the  button on the remote control, refer to page 19. When you close the tailgate, the system is rearmed. ◀

## Switching off the alarm

- ▷ Unlock the vehicle using the remote control, refer to page 19
- ▷ Turn the ignition key to position 1.

## Indicator lamp displays



- ▷ The indicator lamp below the interior rearview mirror flashes continuously: the system is armed
- ▷ The indicator lamp flashes during arming: door(s), the hood or tailgate are not completely closed. Even if you do not close the alerted area, the system begins to monitor the remaining areas, and the indicator lamp flashes continuously after 10 seconds. However, the interior motion sensor is not activated

- ▷ If the indicator lamp goes out when the system is disarmed: no manipulation or attempted intrusions have been detected in the period since the system was armed

- ▷ If the indicator lamp flashes for 10 seconds after the system is disarmed: an attempted entry has been detected in the period since the system was armed.

Following triggering of an alarm, the indicator lamp will flash continuously.

## Avoiding unintentional alarms

The tilt alarm sensor and interior motion sensor may be switched off at the same time. You can do this to prevent a false alarm from being triggered in garages with elevator ramps, for instance, or when the vehicle is transported by trailer or train:

Lock twice:

- ▷ Press the  LOCK button on the remote control twice consecutively
- ▷ Lock using the door lock twice.

The indicator lamp lights up briefly and then flashes continuously. The tilt alarm sensor and the interior motion sensor are deactivated as long as the system is armed.



If you wish, the tilt alarm sensor and interior motion sensor are permanently switched off. You can have this set at your BMW Sports Activity Vehicle Center. ◀

## Interior motion sensor

In order for the interior motion sensor to function properly, the windows and panorama glass roof must be completely closed.

However, be sure to switch off the interior motion sensor – refer to Avoiding unintentional alarms – when you

- ▷ leave children or animals in the vehicle
- ▷ the windows or panorama glass roof are to remain open.



The tilt alarm sensor and interior motion sensor are switched off inad-

vertently if convenience closing of windows and panorama glass roof is interrupted within the first 10 seconds and then reinitiated. If this has occurred, the system must be disarmed and then rearmed. ◀

امداد خودرو فارما

تلفن شبانه روزی: ۰۸۵-۸۸۸۶۲-۰۲۱

FarmaSOS.com

# Adjustments

## Sitting safely

The ideal sitting position can make a vital contribution to relaxed driving that is as fatigue-free as possible. The sitting position plays an important role together with the safety belts and airbags in providing occupants with maximum levels of passive safety in an accident. Therefore, observe the following instructions, as otherwise the protective function of the safety systems may be impaired.

For additional information on transporting children safely, refer to page 34.

## Sitting safely with airbags

 Always maintain an adequate distance between yourself and the airbags. Always hold the steering wheel by its rim with hands at the 9 o'clock and 3 o'clock positions, to minimize the risk of injuries to your hands and arms in the event of airbag deployment.

No one and nothing is to come between the airbags and the seat occupant.

Do not use the cover of the front airbag on the front passenger side as a storage area. Make sure that the front passenger is correctly seated, i.e. feet or legs not resting on the instrument panel, as otherwise leg injuries can result if the knee and front airbag is triggered.

Never let an occupant's head rest near or on a side airbag because the inflating airbag could cause a serious or fatal injury. ◀

Even if you adhere to all the instructions injuries resulting from contact with airbags cannot be fully excluded, depending on the circumstances. The ignition and inflation noise may provoke a mild – usually temporary – hearing loss in extremely sensitive individuals.

For airbag locations and additional information on airbags, refer to page 54.

## Sitting safely with safety belts

Even though there is an airbag, wear a safety belt every time you get in the vehicle. Although airbags enhance safety by providing added protection, they are not a substitute for safety belts.

Your vehicle has five seats that are all equipped with a safety belt.

 Occupants should sit upright and be properly restrained at all times: infants and small children in appropriate child-restraint systems; larger children and adults using the safety belts.

Expectant mothers should always wear their safety belts, taking care to position the lap belt against the lower hips, where it will not exert pressure against the abdominal area.

Never allow more than one person to wear a single safety belt. Never allow infants and small children to ride in a passenger's lap. Do not route the belt across your neck, or run it across sharp edges. Be sure that the belt does not become caught or jammed. Avoid twisting the belt while routing it firmly across the hips and shoulder. Do not allow the belt to rest against hard or fragile objects. Otherwise, in the event of a frontal impact, a loose lap belt could slide over your hips, leading to abdominal injury. Avoid wearing clothing that prevents the belt from fitting properly and pull the lap belt periodically to readjust the tension across your shoulder in order to avoid a reduction in the retention effect of the safety belt. ◀

For fastening safety belts, refer to page 30.

## Seats

### Note before adjusting

 Never try to adjust your seat while operating the vehicle. The seat could respond with unexpected movement, and

the ensuing loss of vehicle control could lead to an accident.

Especially on the passenger's side, do not incline the backrest too far to the rear while the vehicle is being driven, as otherwise there is a danger in the event of an accident of sliding under the safety belt, eliminating the protection normally provided by the belt. ◀

Please observe the information on using safety belts provided on page 30 and the information on the head restraints on page 28.

### Seat adjustment



To ensure that the safety systems continue to provide optimized protection, please observe the adjustment instructions above. ◀

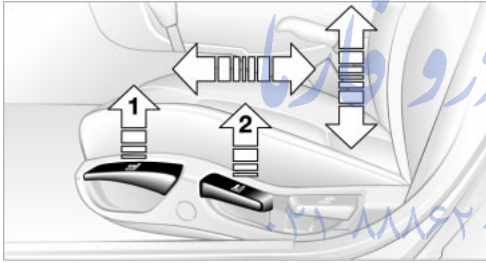

- 1 Longitudinal direction  
Pull the lever and slide the seat into the desired position.  
After you release the lever, move the seat forward or backward slightly so that it engages fully
- 2 Height  
Pull the lever and apply weight to or remove weight from the seat as required

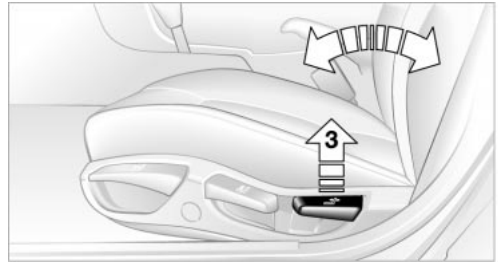

- 3 Backrest angle  
Pull the lever and apply weight to or remove weight from the backrest as required

### Adjusting the BMW sports seat\*

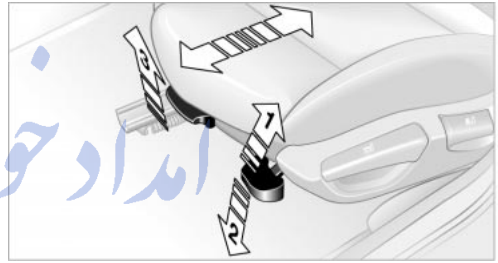

You can also adjust the tilt and the thigh support:

- 1 Upward tilt:  
Pull the lever as many times as required to set the desired tilt
- 2 Downward tilt:  
Press the lever as many times as required to set the desired tilt
- 3 Thigh support:  
Pull the lever and move the thigh support in the longitudinal direction

### Head restraints



Align the head restraints so that their center is approximately at ear level, as otherwise the risk of spinal injuries is increased in the event of an accident. ◀

## Adjustments

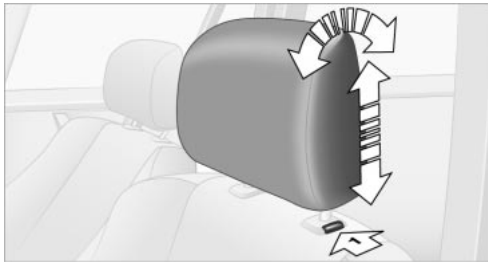

Height adjustment: pull or press.

 To reach the lowest positions, press button **1**. ◀

To adjust the front head restraint tilt angle: adjust by tilting.

### Removal - front

1. Pull the head restraint upward to the stop
2. Press button **1** and remove the head restraint.

### Installation - front

1. Press button **1** and slide the head restraint into its supports
2. Adjust the head restraint.

### Power seat\*

 To ensure that the safety systems continue to provide optimal protection, please observe the adjustment instructions on page **27**. ◀

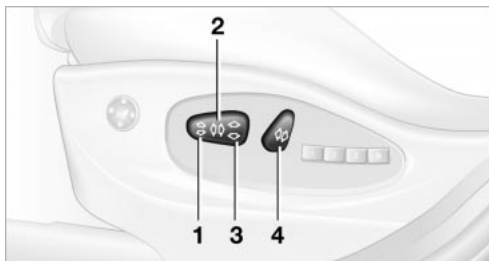

- 1 Angle
- 2 Longitudinal direction
- 3 Height
- 4 Backrest angle

Set the head restraint manually, refer to left column.

### Lumbar support\*



You can also adjust the contours of the backrest to obtain additional support in the lumbar region.

The upper hips and spinal column receive supplementary support to help you maintain a relaxed, upright sitting position.

- ▶ Press the front or rear of the switch: Increase or decrease curvature
- ▶ Press the upper or lower end of the switch: Increase the upper or lower curvature.

### Seat and mirror memory\*



You can store and select three different adjustment settings for the driver's seat and exterior mirrors.

The adjustment of the lumbar support is not stored in the memory.

### Storing

1. Turn the ignition key to position 1 or 2
2. Set the desired seat and exterior mirror position

3. Press **MEMORY** button:  
The indicator lamp in the button lights up
4. Press the desired memory button **1**, **2** or **3**:  
The indicator lamp goes out.

### Selecting a stored setting

 Do not call up a position from the memory while the vehicle is moving, as otherwise there is a risk of accident from unexpected seat movement. ◀

### Convenience mode

1. Open the driver's door after unlocking or turn the ignition key to position 1
2. Briefly press the desired memory button **1**, **2** or **3**.  
The system immediately cancels the adjustment procedure when you press one of the seat adjustment buttons or use one of the memory buttons.

### Safety feature

1. Close the driver's door and turn the ignition key to position 0 or 2
2. Press the desired memory button **1**, **2** or **3** and maintain pressure until the adjustment process has been completed.

 If you press the **MEMORY** button accidentally:  
Press the button a second time – the indicator lamp goes out. ◀

 You can have your vehicle programmed to automatically dial in your own individual adjustment settings for the seat and exterior mirror position whenever you use your personal remote control to unlock the vehicle. ◀

 If you make use of this adjustment, be sure that the footwell behind the driver's seat is unobstructed before unlocking the vehicle. If you fail to do so, any persons, animals or objects behind the seat could be injured or damaged by a rearward movement of the seat. ◀

## Heated seats\*



The seat cushion and backrest can be heated when the ignition key is in position 2.

To call up different temperature levels:  
Press the button repeatedly.

To switch off from a higher heat setting:  
Press the button and hold it slightly longer.

## Safety belts

Even though there is an airbag, wear a safety belt every time you get in the vehicle. Although airbags enhance safety by providing added protection, they are not a substitute for safety belts.



### Fastening

Make sure you hear the latch plate engage in the belt buckle.

 Please fasten safety belt warning lamp:  
Lights up for a few seconds or until safety belts are fastened. Depending on you vehicle version, a signal\* sounds simultaneously.



## Releasing

1. Press the red button in the buckle
2. Hold the belt
3. Guide the belt back into its reel.

The upper shoulder strap's anchorage point will be in the correct position for seat occupants of every build if the seat is correctly adjusted, refer to page 27.

The two rear safety belt buckles integrated in the rear seat are for passengers sitting on the left and right. The belt buckle embossed with the word CENTER is intended exclusively for use by passengers riding in the center position. ◀

## Damage to safety belts

 If the safety belts are damaged or stretched in an accident: have the entire belt system, including the tensioning mechanisms, replaced at your BMW Sports Activity Vehicle Center. Have the belt anchorage points inspected for damage at the same time. Failure to observe this precaution may prevent the safety belts from effectively providing optimal protection when needed. If a child-restraint system was in the vehicle during an accident, consult the manufacturer's instructions regarding replacement. ◀

## Steering wheel

### Adjustments

 Do not adjust the steering wheel while the vehicle is moving. There is a risk of accident from unexpected movement. ◀

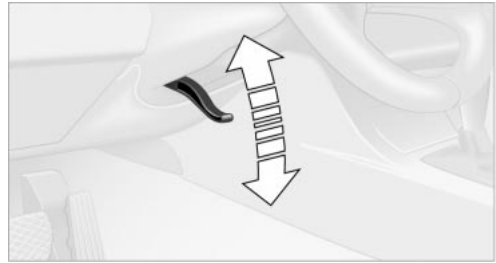

1. Fold the clamping lever downward
2. Adapt the steering wheel in the longitudinal direction and height of the seat position
3. Fold the clamping lever back up.

### Steering wheel heating\*

The button for steering wheel heating is located in the steering wheel, refer to page 14.



Steering wheel heating: switching on/off.

The steering wheel heating operates from ignition key position 2.

Press the button to activate or deactivate this system. تلفن شبانه

The indicator lamp within the button lights up when the steering wheel heating is in operation.

## Mirrors

### Adjusting exterior mirrors



- 1 Mirror switch for 4-way adjustment
- 2 Left/right selector switch

 To prevent the exterior mirrors on this vehicle from being damaged, always fold them in by hand before entering an automatic car wash. ◀

### Adjusting manually

You can also adjust the mirrors manually: Press the edges of the mirror glass.

Storing the mirror positions, refer to Seat and mirror memory on page 29.

### Convex mirror

 The mirror on the passenger's side features a lens with a more convex surface than the mirror installed on the driver's side. When estimating the distance between yourself and other traffic, bear in mind that the objects reflected in the mirror are closer than they appear. This means that estimations of the distance to following traffic should not be regarded as precise. ◀

### Electric heaters

Both mirrors are heated automatically in ignition key position 2.

### Passenger-side exterior mirror tilt function



### Automatic curb monitor\*

1. Select the driver's exterior mirror with the switch 1
2. When you engage reverse gear or selector-lever position R, the exterior mirror on the front passenger side tilts downward slightly. This allows the driver to see the area immediately adjacent to the vehicle – such as a curb – when parking, etc.



You can have the angle of downward tilt set in dependence on the key used. ◀

### Interior rearview mirror



To reduce the dazzle effect of following vehicles at night, turn the knob.

### Interior and exterior mirrors, automatic dimming feature\*



These mirrors automatically dim through an infinitely-variable range. They automatically revert to their undimmed mode whenever the transmission is placed in reverse gear or selector lever in position R.

 For trouble-free operation, keep the photocells unobstructed and clean and do not cover the area between the interior rearview mirror and the windshield. Do not attach any kind of stickers on the windshield in front of the mirror, either. ◀

# Vehicle Memory, Key Memory

## How the system functions

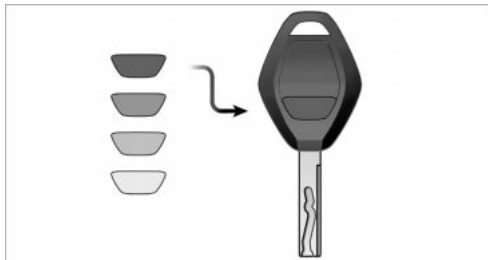

You have probably frequently wished that you could configure individual functions of your vehicle to reflect your own personal requirements. In developing your vehicle, BMW has incorporated a number of options for personal adjustment. You can have these programmed at your BMW Sports Activity Vehicle Center.

There are vehicle-related and person-related adjustments: Vehicle Memory and Key Memory. You can configure up to four different basic adjustments for four different persons. The only requirement is that each person uses his or her own master key with remote control.

When your vehicle is unlocked with the remote control, the vehicle recognizes the individual user by means of a data exchange with the key, and makes adjustments accordingly.

In order for you to distinguish between the remote control master keys, colored decals are supplied together with the keys.

## What the system can do

Your BMW Sports Activity Vehicle Center can provide you with details on the capabilities of the Vehicle Memory and Key Memory systems.



You will see this symbol throughout the Owner's Manual. It is to remind you at appropriate places of the settings that are available to you. ◀

## Examples of Vehicle Memory functions

- ▷ Different acknowledgment signals to confirm locking/unlocking of the vehicle, refer to page 18
- ▷ Activate/deactivate function for pathway lighting, refer to page 57
- ▷ Activate/deactivate daytime driving lamps, refer to page 57
- ▷ Setting measurement units for displays in the instrument cluster of the time, outside temperature, distance driven and fuel consumption, refer to page 47
- ▷ Active PDC is indicated by an acoustic sound signal when reverse gear or selector-lever position R is engaged, refer to page 49
- ▷ The rear window defroster switches on automatically, refer to page 61
- ▷ Different acknowledgment signals to confirm arming/disarming the alarm system, refer to page 25
- ▷ After an ice warning has been issued, the display of the computer returns to the previous adjustment, refer to page 47
- ▷ Acoustic warning if the ignition key remains in the ignition lock after the driver's door has been opened, refer to page 21.

## Examples of Key Memory functions

- ▷ On unlocking, first unlock the driver's door, then the entire vehicle, refer to page 19
- ▷ Locking the vehicle after moving off, refer to page 20
- ▷ Automatic adjustment of the driver's seat and exterior mirror position for each person when unlocking the vehicle, refer to page 30
- ▷ Angle of downward tilt of mirror on passenger side, refer to page 32.

# Transporting children safely

## The right place for children

### Children always in the rear

Accident research shows that the safest place for children in a vehicle is in the rear seat.

Older children should be tightly secured with a safety belt, after they have outgrown a booster seat that is appropriate for their age, height and weight.

 A child sitting in the rear seat and not properly restrained may place his or her head on or near the airbag, if so equipped. For example, a child – even though belted – may fall asleep with his or her head against the side airbag. It may be difficult for a driver to ensure that children in the rear seat will remain properly positioned at all times and do not place their heads on or near the side airbag. Therefore, we recommend that the rear side airbags, if provided, be deactivated if you plan to transport children in the rear seat. ◀

### Deactivation of the rear seat side airbags

The rear seat side airbags may already have been deactivated by a BMW Sports Activity Vehicle Center. Labels in the rear door opening should indicate the status of your rear seat side airbags. If you are uncertain of their status, or wish to have the airbags activated or deactivated, please contact your BMW Sports Activity Vehicle Center.

### Child-restraint system in rear

 Children under 13 years of age and children less than 5 ft/150 cm tall should always ride in the rear and the restraint systems should be properly adjusted. ◀

Younger children should be secured in an appropriate forward-facing child-restraint

system that has first been properly secured with a safety belt.

All rear seating positions in your vehicle meet the recommendations of SAE J1819, an industry-recommended practice for securing child-restraint systems in motor vehicles.

### Exception for the front passenger seat

 Should it become necessary to use a child-restraint system on the front passenger seat, the airbags on the passenger's side must be deactivated. The passenger airbag indicator lamp above the interior rearview mirror must light up continuously. Otherwise, the front passenger airbags remain active and there is considerable risk of injury to children if the airbags are triggered, even with a child-restraint system. In this case, children should be seated in the rear and the system should be checked at your BMW Sport Activity Vehicle Center. ◀

 Never install a rearward-facing child-restraint system in the front passenger seat of this vehicle if the passenger airbag is not deactivated. If you do so, the child could be severely injured when the airbag is triggered.

Your vehicle is equipped with an airbag supplemental restraint system for the front passenger. Because the backrest on any rearward-facing child-restraint system – of the kind designed for infants under 1 year and 20 lbs/9 kg – would be within the airbag's deployment range, you should never mount such a system in the front passenger seat, since the impact of the airbag against the child restraint's backrest could lead to serious or fatal injuries. ◀

More information on automatic deactivation of the front passenger airbags, refer to page 55.

## Installing child-restraint systems

Before installing any child-restraint system or child seat, read the following:

 Observe the child-restraint system manufacturer's instructions for installation and use. Otherwise the degree of protection can be reduced.

After an accident, have all parts of the relevant vehicle safety belt system checked by a BMW Sports Activity Vehicle Center and replaced if necessary. ◀

Commercially-available child-restraint systems are designed to be secured with a lap belt or with the lap belt portion of a combination lap/shoulder belt. Improperly or inadequately installed restraint systems can increase the risk of injury to children. Always read and follow the instructions that come with the system.

### Child seat security



All of the rear belt retractors and the front passenger's safety belt can be locked for mounting and securing child-restraint systems.

Information regarding this is located near the buckle latch of each safety belt.

### To lock the safety belt

Pull the entire length of the belt from the belt retractor. Allow the reel to retract the belt somewhat and engage the buckle, then tighten the belt against the child-restraint system. The retraction mechanism is now locked.

### To unlock the safety belt

Release the buckle, remove the child-restraint system and allow the belt retractor to reel the belt completely in.

### Child-restraint system with tether strap

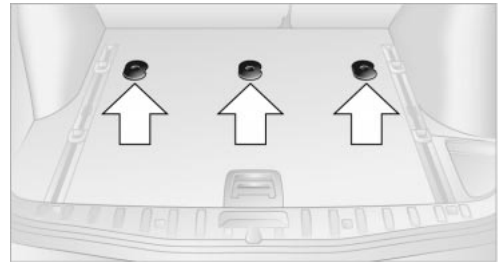

If you use a child-restraint system with a tether strap, three additional tether anchorage points have been provided, refer to the arrows in the illustration. Depending on the location selected for seating in the rear passenger area, attach the tether strap to the corresponding anchorage point to secure the child-restraint system, as shown in the illustration below.

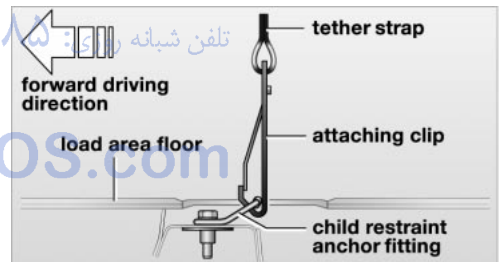

Each seating position is fitted with a head restraint.

Outer seating positions:

Lift the head restraint and pass the tether strap between the head restraint and the seat back. It is recommended to readjust the head restraint into the lowest possible position.

Center seating position:

The head restraint must be adjusted into the lowest possible position. Pass the tether strap over the head restraint.

 Adjust the tether strap according to the child-restraint manufacturer's instructions. ◀

### LATCH\* child-restraint fixing

LATCH: Lower Anchor and Tethers for Children.

The rear outer seating positions are provided with anchors for a LATCH child-restraint fixing.

#### Access to anchorage points

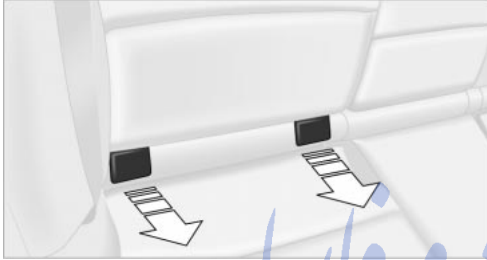

The illustrations show the left rear seat as an example. The anchorage points for the LATCH child seat fixing are located behind the cover caps.

Remove the cover caps toward the front. Press on to remount.



Canadian models only:

The anchorage points for the LATCH child-restraint fixing are identified by buttons.

 To fit the child seat fixing LATCH, follow the operating and safety instructions of the manufacturer. ◀

Before mounting the LATCH child-restraint fixing, remove the cover caps.

1. Engage the center safety belt into the belt buckle
2. Pull the belt away from the area of the child seat fixing.

### For driving

 With side airbags in the rear, make sure that children do not lean out of the child's seat toward the door panel, as otherwise major injuries can result if the side airbags are triggered. ◀

You can have the rear side airbags permanently deactivated.

Your BMW Sports Activity Vehicle Center will be happy to advise you.

### Child-safety lock of rear doors



Slide down the safety levers on the rear doors:

The door can now be opened from the outside only.

### Safety switch for power windows

Always press the safety switch for the electric power windows, refer to page 22, when children are in the rear of the vehicle.

# Driving

## Ignition lock

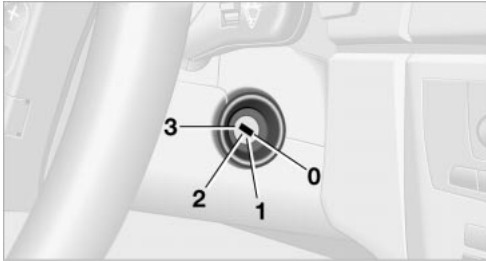

### 0 Steering locked

The key can only be inserted or removed in this position.

After removing the key, turn the steering wheel slightly to the left or right until you hear the lock engage.

 Vehicles with automatic transmission: Only move the selector lever from position P with the engine running. To turn the key back to position 0 or to remove it, first place the selector lever in position P: Interlock. ◀

### 1 Steering unlocked

A slight steering wheel movement often makes it easier to turn the key from 0 to 1. Individual current consumers are ready for operation.

### 2 Ignition switched on

All vehicle systems are ready for operation.

### 3 Engine start

## Engine

Do not allow the engine to warm up while idling. Drive off immediately at moderate engine speed.

Engine idle speed is controlled by the engine computer system. Increased speeds at startup are normal and should

decrease as the engine warms up. If engine speed does not decrease, service is required.

To prevent the battery from discharging, always switch off electrical devices which are not in use and the ignition when the vehicle is not being driven.

 Do not run the engine in closed rooms, as otherwise inhaling toxic exhaust gases can cause unconsciousness and death. The exhaust gases contain carbon monoxide, an odorless and colorless, but highly toxic gas. Do not leave the vehicle unattended with the engine running, since an unattended vehicle with a running engine represents a safety hazard. When driving, standing at idle and while parking take care to avoid possible contact between a hot exhaust system and any highly flammable materials such as hay, leaves, grass, etc. Such contact could lead to a fire, resulting in serious personal injury and property damage. ◀

### Indicator lamps

 If the Service Engine Soon indicator lamp comes on either continuously or intermittently, this indicates a fault in the emissions-related electronic systems. Although the vehicle remains operational, you should have the systems checked by your BMW Sports Activity Vehicle Center at the earliest possible opportunity.

The illuminated indicator informs you of the need for service, not that you need to stop the vehicle. However, the systems should be checked by your BMW Sports Activity Vehicle Center at the next opportunity.

If the indicator blinks or flashes, this indicates a high level of engine misfire. Reduce speed and contact the nearest BMW Sports Activity Vehicle Center immediately. Severe engine misfiring over even a short period of time can seriously damage emis-



sion control system components, especially the catalytic converter.



Service Engine Soon indicator lamp for Canadian models.



Malfunction in the engine electronics.

You can continue to drive with reduced engine output or engine speed. Please have it checked by your BMW Sports Activity Vehicle Center.

## Starting the engine

When starting the engine, do not press the accelerator pedal.



Vehicles with manual transmission:

Step on the clutch when starting the vehicle. A lockout prevents the engine from starting if the clutch is not depressed. ◀



Do not actuate the starter for too short a time. Do not turn it for more than approx. 20 seconds. Release the ignition key immediately as soon as the engine starts. ◀

If the engine fails to start on the first attempt, for instance, if it is very hot or cold:

- ▷ Press the accelerator pedal halfway down while engaging the starter.

During a cold start at very low temperatures, as of approx. +5 °F / -15 °C, at high altitudes over 3,300 ft / 1,000 m:

- ▷ For the first attempt, run the start for longer, approx. 10 seconds
- ▷ Press the accelerator pedal halfway down while engaging the starter.



Avoid frequent starting or quick succession or repeated start attempts in which the engine does not start. Otherwise, the fuel is not burned or inadequately burned and there is a danger of overheating and damaging the catalytic converter. ◀

## Manual transmission

1. Engage the handbrake
2. Gearshift lever in idle position
3. Press the clutch pedal
4. Start the engine.



Before leaving the vehicle with the engine running, place the gearshift lever in idle position and apply the handbrake.

Never leave an unattended vehicle with the engine running, as such a vehicle represents a potential safety hazard. ◀

## Automatic transmission

1. Press the brake pedal
2. Place the selector lever in position P or N
3. Start the engine.



To prevent the vehicle from rolling, always select position P and engage the handbrake before leaving the vehicle with the engine running.

Never leave an unattended vehicle with the engine running, as such a vehicle represents a potential safety hazard. ◀

## Switching off the engine



Do not remove the ignition key when the vehicle is moving, as otherwise the steering could lock.

When leaving the vehicle, always remove the ignition key and lock the steering. When parking on downward inclines, apply the handbrake. ◀

## Manual transmission

Turn the ignition key to position 1 or 0.

## Automatic transmission

Engage selector-lever position P, turn ignition key to position 1 or 0.

## Handbrake

The handbrake is primarily intended to prevent the vehicle from rolling while parked; it brakes the rear wheels.

## Indicator lamp



The indicator lamp lights up from ignition switch position 2 with the handbrake set – an acoustic signal also sounds when starting off.





Indicator lamp for Canadian models.

## Manual transmission

### To engage



The lever engages automatically.

### To release

Pull up slightly on the lever, press the button and lower the lever.

 If exceptional circumstances should make it necessary to engage the handbrake while the vehicle is in motion, do not pull it too strongly. In doing so, continuously press the button of the handbrake lever.

Strong application of the handbrake can lead to overbraking of the rear axle and associated 'fishtailing' of the vehicle rear end.

The brake lamps do not light up when the handbrake is applied.

Vehicles with manual transmission:

When parking on inclines, apply the handbrake, as even engaging the first or reverse gear might not under certain circumstances secure the vehicle against moving.

Vehicles with automatic transmission:

Engage selector-lever position P. ◀

 To prevent corrosion and one-sided braking action, occasionally apply the handbrake lightly when the vehicle is slowly coming to a standstill at a traffic light if the traffic conditions are suitable. ◀

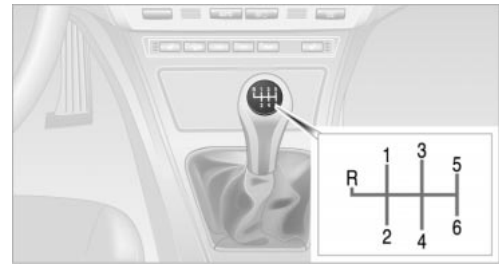

 While shifting gear in the 5th/6th gear level, make sure that you press the gearshift lever to the right to prevent inadvertently selecting a gear in the 3rd/4th gear level.

Do not hold the vehicle in place on slopes by slipping or riding the clutch. Use the handbrake instead, since a slipping clutch increases clutch wear. ◀

### Reverse

Select only when the vehicle is stationary. Press the gearshift lever to the left to overcome the resistance.

As you do this, the backup lamps will turn on automatically when the ignition key is in position 2.

## Automatic transmission with Steptronic\*

You can drive as with a normal automatic transmission. In addition, you can also shift manually.

If you move the selector lever from position D to the left into gearshift gate M/S, this activates the sports-style shift programs of the automatic transmission. As soon as you move the selector lever slightly towards + or -, the Steptronic shifts gear and manual operation is activated. When you wish to use the automatic transmission mode again, move the selector lever to the right into the D position.

## Selector lever positions



P R N D M/S + -

### Engine started

The engine can only be started in selector-lever positions P – Park – or N – Neutral.

### Range selection

An interlock prevents inadvertent gear-shifts into selector-lever positions R and P. To cancel the interlock, press the button on the front of the selector-lever knob.

### Shiftlock



Press the brake pedal before shifting out of P or N; the shift command will not be executed unless the brake is applied – Shiftlock. ◀



To prevent the vehicle from 'creeping' after you select a range, maintain pressure on the brake pedal until you are ready to start. If you leave the vehicle with the engine running, engage selector-lever position P and apply the handbrake. If you fail to do this, the vehicle could move. Never leave an unattended vehicle with the engine running, as such a vehicle represents a potential safety hazard. ◀

### P Park

Select only when the vehicle is stationary. The transmission locks to prevent the rear wheels from turning.

### R – Reverse

Select only when the vehicle is stationary.

### N – Neutral

Select only if your journey is interrupted for a longer period.

### D Drive – Automatic shift program

This position is designed for driving under all normal operating conditions. All forward gears are available.

### Kickdown

A kickdown provides you with maximum acceleration and the maximum road speed in position D.

Press the accelerator pedal past the increased resistance point at the full-throttle position.

### M/S Manual mode and Sport Program

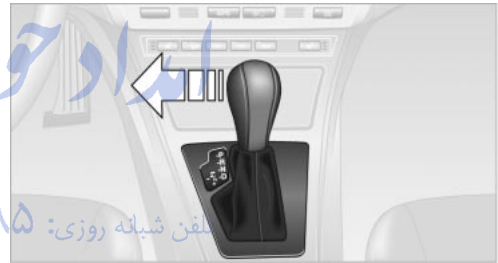

Shifting from D into M/S activates the Sport program and this is indicated with SD in the gear display. The Sport Program is designed for performance-oriented driving.

The first time the selector lever is even slightly touched, the automatic transmission shifts from the Sport program into manual operation.

If you start to move the selector lever towards +, the transmission shifts upwards; moving it towards – shifts downwards. The gear display shows M1 through M5.

Upshifts and downshifts are executed only when they will result in a plausible combination of engine and vehicle speed; thus, for example, a downshift that would cause the engine to overrev will not be executed by the system. The gear selected will

appear briefly in the instrument cluster followed by the current gear.

 To obtain maximum acceleration, for passing maneuvers, etc., during operation in the manual mode, use the kickdown or downshift manually. ◀

Shifting from M/S to the selector-lever positions P, R and N is only possible by going through D.

## Possible displays

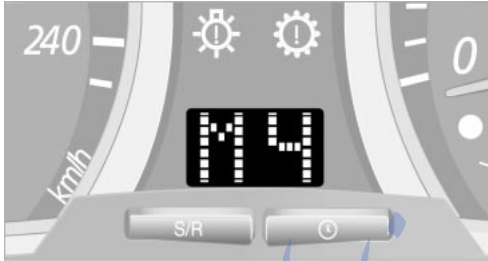

P R N D SD M1 M2 M3 M4 M5

## Malfunctions



If the indicator lamp lights up, there is a function fault in the transmission system.

While it will remain still possible to move the selector lever to any desired position, the transmission will revert to operation in its default mode with only a limited number of forward gears.

Avoid high loads and drive to the nearest BMW Sports Activity Vehicle Center.



Never work in the engine compartment with any of the forward or reverse gears engaged, as the vehicle could start to move. ◀

Information on jump-starting and towing starts on page 108.

## Turn signal indicators/ headlamp flasher

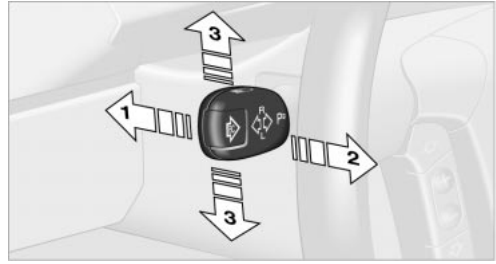

- 1 High beams – blue indicator lamp
- 2 Headlamp flasher – blue indicator lamp
- 3 Turn signal indicators – green indicator accompanied by periodic clicking sound from the relay

 If the flashing indicator lamp and the clicking from the relay are both faster than normal, this indicates that one of the turn signal indicator bulbs is defective. ◀

## Signaling briefly

Press the lever up to but not beyond the resistance point. It then returns to the center position when released.

## Washer/wiper system/Rain sensor\*

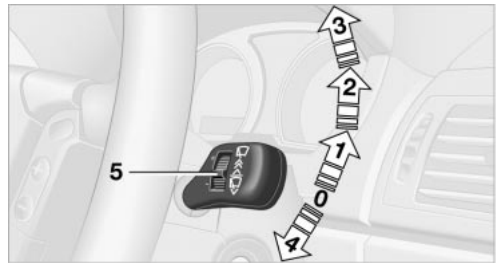

- 0 Wipers retracted
- 1 Intermittent or rain sensor operation
- 2 Normal wipe
- 3 Fast wipe
- 4 Brief wipe

- 5 Serrated dial for adjustment of the wipe interval or the sensitivity of the rain sensor

### Retracted position

The right wiper is partially concealed by the hood.

To move the wipers into a vertical position:

1. Switch on wipers in lever position 1
2. When the wipers are approximately vertical, move the ignition key to position 0.

For changing the wiper blades, refer to page 99.

 Fold the wipers back down onto the windshield before you turn the ignition key to position 1 or 2 again. If you do not, they could be damaged. ◀

### Intermittent mode

Not on vehicles with rain sensor.

You can set the wipe interval to four stages with the serrated dial 5.

In addition, the wipe interval is varied automatically depending on road speed.

### Rain sensor\*

The rain sensor is positioned on the windshield, directly in front of the interior rear-view mirror.

 Deactivate the rain sensor when passing through an automatic car wash. Failure to do so could result in damage caused by undesired wiper activation. ◀

### Activating

- ▷ Move the lever to position 1 with the ignition key in position 1 or higher. The wipers travel once across the windshield, regardless of the weather conditions.

You can leave the lever permanently in position 1 and then only need to activate the rain sensor as of ignition key position 1. To do so:

- ▷ Briefly turn the serrated dial 5 or

- ▷ Cleaning windshield 1, refer to next section.

Adjust sensitivity: turn the serrated dial 5.

### Deactivating

- ▷ Move lever to position 0.

### Normal wipe

The system switches automatically to intermittent mode when the vehicle is not moving, not on vehicles with rain sensor.

### Fast wipe

The wipers operate at normal speed when the vehicle is not moving, not on vehicles with rain sensor.

### Cleaning windshield, rear window and headlamps\*

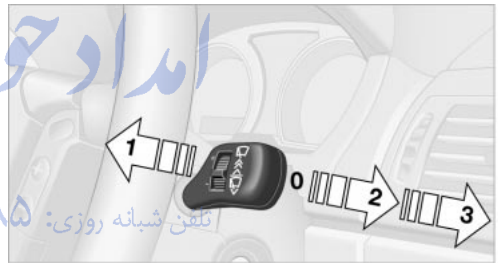

0 Wipers retracted

1 To clean windshield and headlamps

2 Rear window wiper intermittent mode

3 Clean the rear window

 Do not use the washers if there is any danger that the fluid will freeze on the windshield. If you do so, your vision could be obscured. To avoid freezing, use a washer fluid antifreeze, refer to page 94. Do not use the washers when the reservoir is empty. This could cause damage to the washer pump. ◀

### Cleaning the windshield

The system sprays washer fluid against the windshield and activates the wipers for a brief period.

The windshield washer nozzles are auto-

matically heated as of ignition key position 2.

### Cleaning headlamps\*

When the vehicle lighting system is switched on, the headlamps are cleaned at regular and appropriate intervals.

### Rear window wiper

Rear window wiper in intermittent mode. When reverse gear is engaged, the wiper operates continuously.

You can also program the interval:

1. Briefly move the wiper lever from position 0 to position 2
2. Wait for desired interval; maximum of 30 seconds
3. Move the wiper lever from position 0 to position 2 again

To change the wiper blades, refer to page 99.

### Cruise control\*

The vehicle maintains and stores the speed that you set as of a speed of approx. 20 mph/30 km/h.

You can use cruise control whenever the system is active while the engine is running.

### Indicator lamp



Indicator lamp in the instrument cluster lights up green:  
System ready for operation using the buttons in the steering wheel.

### Activating the system

I/O

From ignition key position 2:  
Press button in steering wheel; the indicator lamp in the instrument cluster comes on. You are able to use the cruise control.



Do not use the cruise control when driving on winding roads, in heavy traffic or in poor road conditions – e.g.

snow, rain, ice, loose road surface – that do not permit a constant speed. ◀

### Deactivating system

I/O

Press the button repeatedly until the indicator lamp in the instrument cluster goes out.

The cruise control is also deactivated when the ignition key is turned to position 0. The speed stored in the memory is deleted in the process.

### Maintaining and storing speed or accelerating



Briefly press button +:

The system maintains and stores the current vehicle speed. Every time you briefly press the button, the vehicle's speed increases by roughly 1-mph/1 km/h.

Press and hold button +:

The vehicle accelerates without pressure on the accelerator pedal. When you release the button, the system maintains and stores the current speed.



If, on a downhill gradient, the engine's braking effect is not sufficient, the controlled speed can be exceeded. Speed can drop on uphill grades if the engine output is insufficient. ◀

### Decelerating



Briefly press button –:

Every time you briefly press the button, the vehicle's speed decreases by roughly 1 mph/1 km/h if you are already driving with cruise control.

Press and hold button –:

With the cruise control active, the system automatically reduces the throttle opening to slow the vehicle. When you release the button, the system maintains and stores the current speed.

## Interrupting the cruise control

1/0

When the system is activated, press button. The indicator lamp stays on. You can use the cruise control again whenever required by calling up the speed that was stored last.

In addition, the system is automatically interrupted in response to the following conditions:

- ▷ When you apply pressure to the brake pedal
- ▷ When you apply pressure to the clutch pedal or when you move the automatic transmission selector lever from D to N
- ▷ If you exceed or fall below the controlled speed for an extended period, by pressing the accelerator, for example.

## Recalling the stored speed



Press button:

The vehicle accelerates to and maintains the last speed stored.

امداد خودرو واریا

تلفن شبانه روزی: ۰۲۱-۸۸۷۲۰۸۵

FarmaSOS.com

# Everything under control

## Odometer

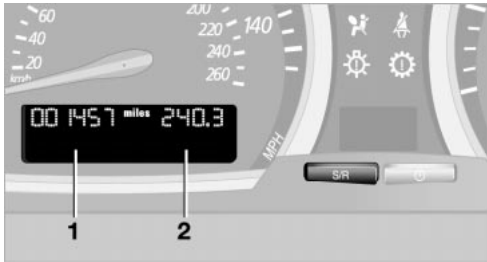

- 1 Odometer
- 2 Trip odometer

### Odometer

You can activate the displays shown in the illustration in ignition key position 0 or with the ignition key removed by pressing the button in the instrument cluster.

### Trip odometer

To reset to zero:

1. Ignition key in position 1
2. Press the button until the trip odometer is reset to zero.

## Tachometer



Engine speeds in the red warning field must be avoided.

In this range, the fuel supply is interrupted to protect the engine.

## Fuel gauge

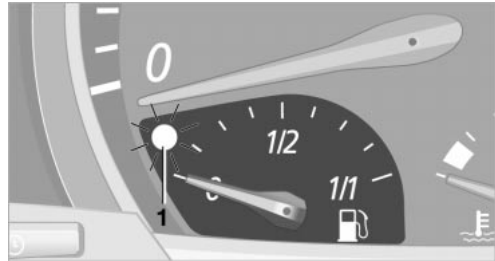

If the indicator lamp 1 starts to light up continuously, there are approx. 2 gallons/ 8 liters of fuel in the tank.

Fuel tank capacity:  
approx. 17.7 gallons/67 liters.

If the tilt of the vehicle varies, when you are driving in mountainous areas, for example, the indicator may fluctuate slightly.

**⚠** Refuel well before the tank is empty, as otherwise engine functions will not be ensured and damage can occur if you drive down to the last drop. ◀

When you switch on the ignition, the indicator lamp comes on briefly to confirm that the system is operational.

## Coolant temperature gauge

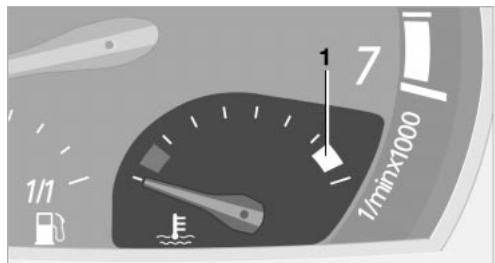

### Blue

The engine is still cold. Drive at moderate engine and vehicle speeds.

FarmaSOS.com

## Between the blue and red fields

Normal operating range. The dial may wander into the red field.

## Red

Comes on while driving:  
The engine is overheated. Switch off the engine immediately and allow it to cool down.

Checking coolant level, refer to page 96.

When you switch on the ignition, the warning lamp 1 comes on briefly to confirm that the system is operational.

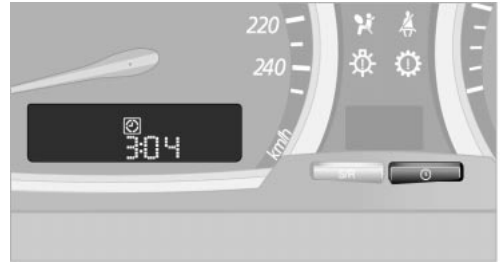

## Service Interval Display



## Remaining distance until next service due

The displays shown in the illustration appear for a few seconds as of ignition key position 1 or after starting the engine.

Together with the lettering OILSERVICE or INSPECTION, the next scheduled service and remaining distance to this service is shown in miles/kilometers.

The remaining distance is determined on the basis of the past driving style.

A flashing display and a – before the numerical value mean that the service interval has been passed by the displayed number of miles/kilometers. Please make an appointment with your BMW Sports Activity Vehicle Center.

## Replacing brake fluid

You can have the month and year for the scheduled brake fluid replacement displayed by pressing the right button in the instrument cluster while the next scheduled service is being displayed. With each button touch, the display switches between the scheduled service and scheduled brake fluid replacement.

When the brake fluid replacement is due, the clock symbol also lights up. Please make an appointment with your BMW Sports Activity Vehicle Center.

 Immobilization periods in which the battery is disconnected are not taken into account by the display. Please remember that brake fluid should be changed every two years at the latest, even if the display does not yet indicate that service is required, refer to page 96. ◀

## Clock

If you want to have a permanent clock display, you can also have the time displayed in the display of the car radio, refer to the Owner's Manual for Radio.

You can adjust the clock, also for display in the radio, as follows.



## Setting the time

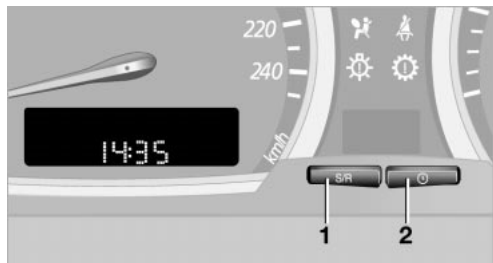

As of ignition key position 1:

### Hours

1. Hold button 2 for a few seconds until the hours are displayed and the colon flashes
2. Press button 1 repeatedly until the desired hour is set

### Minutes

3. Press button 2 to change to the minute display
4. Press button 1 repeatedly until the desired minutes are set
5. Press button 2 to confirm the time.

The set time is transferred to the display of the radio or displayed in the instrument cluster.

### Display mode

Ignition key in position 0 or removed:

Press button 1.

The time and display of the miles/kilometers appear for a few seconds.

## Computer\*

### Mode selection

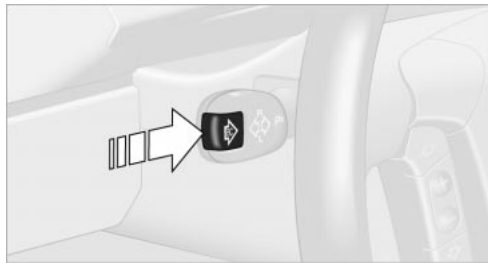

As of ignition key position 1, you can call up information from the computer using the button in the turn signal indicator lever. By pressing the button briefly in the direction of the steering column, you can call up a new function for display.

The displays appear in the following order: Time, outside temperature, average fuel consumption, cruising range, average speed.

As of ignition key position 1, the last active setting is displayed.



If you desire, you can display the following functions in a different unit. ◀

### Outside temperature



### Changing the unit of measure °F/°C

During the display, hold down the button in the turn indicator lever until the display changes.

### Ice warning

If the outside temperature falls below approx. +37.5 °F / +3 °C, the computer switches automatically to the outside tem-

perature display. In addition, an acoustic signal sounds and the display flashes for a short time.



After an ice warning has been issued, the display returns to the previous setting. You can have this activated/deactivated. ◀



Please bear in mind that the ice warning does nothing to alter the fact that glare ice may be present on roads at temperatures higher than +37.5 °F / +3 °C, for instance, on bridges and shaded roads. ◀

### Clock

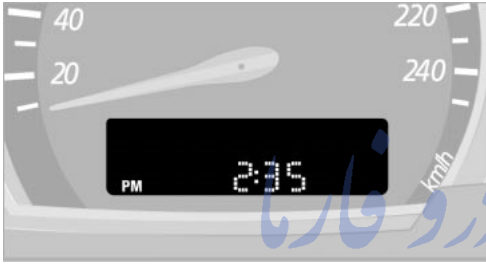

#### 12 or 24 hour mode

If your vehicle is equipped with a computer, you can have the time displayed in the 12 or 24 hour mode.

During the display, hold down the computer button in the turn indicator lever until the display changes.

#### Average fuel consumption

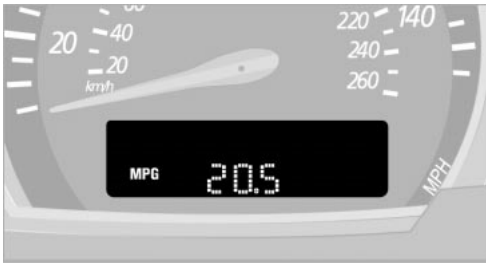

If you press the button in the turn signal indicator lever for a longer period, the currently displayed average value for fuel consumption is recalculated from that moment onwards.

### Cruising range

The cruising range is determined on the basis of the past driving style and the present volume of fuel.



Always refuel as soon as possible once your cruising range falls to below 30 miles/50 kilometers, as otherwise engine functions are not ensured and damage can occur. ◀

### Average speed

If you press the button in the turn signal indicator lever for a longer period, the currently displayed average value for speed is recalculated from that moment onwards.

امداد خودرو فارما

تلفن شبانه روزی: ۰۸۵

FarmaSOS.com

# Technology for comfort, convenience and safety

## Park Distance Control PDC\*

### The concept

PDC provides extra safety and convenience during parking maneuvers. Signal tones indicate the current distance to an object behind or in front of your vehicle. Four ultrasonic sensors in both the bumpers monitor the distance to the nearest object.

The front and rear sensors on the corners have a range of approx. 2 ft/60 cm. The two rear middle sensors have a range of approx. 5 ft/1.50 m and the two front middle sensors of approx. 2.6 ft/80 cm.

 PDC is a parking aid that can indicate objects when they are approached slowly, as is usually the case when parking. Avoid approaching objects too fast, otherwise the system may give warning of physical obstacles too late. ◀

If you are driving with a trailer, the rear sensors are unable to make proper measurements – so they do not switch on.

### Automatic mode

As of ignition key position 2, the system automatically assumes operational status after a few seconds each time you engage reverse gear or selector-lever position R.

 Wait this short period before parking. ◀

 You can have a signal tone programmed into the system to verify that the PDC is active. ◀

### Automatic deactivation

After driving a distance of more than approx. 160 ft/50 m or exceeding a speed of approx. 20 mph/30 km/h, the system switches off and the indicator lamp goes out. You can reactivate the system manually as needed.

### Manual mode



Press the button; the indicator lamp comes on.

### Manual deactivation

Press the button again; the indicator lamp goes out.

### Signal tones

The distance to an object behind the vehicle is signaled in accordance with the position by an intermittent tone from a loudspeaker in the rear-end.

The distance to an object in front of the vehicle is signaled by an intermittent tone from a loudspeaker beneath the instrument cluster.

As the distance between vehicle and object decreases, the intervals between the tones become shorter. The signal tone becomes continuous once the distance to the nearest object falls to below roughly 1 ft/30 cm.

The warning signal is canceled after approx. 3 seconds when the distance to an object remains constant during this time, if you are moving parallel to a wall, for instance.

### Malfunction

The indicator lamp flashes and a short steady signal tone is sounded.

Switch the system off and have the cause of the malfunction corrected by your BMW Sports Activity Vehicle Center.

## Limits of the system

 Even with PDC, final responsibility for estimating the distance between the vehicle and any obstructions always remains with the driver. Even when sensors are involved, there is a blind spot in which objects cannot be detected. The system is also subject to the physical limits that apply to all forms of ultrasonic measurement, such as those encountered with tow bars and trailer couplings, or thin and wedge-shaped objects etc. Low objects already displayed, e.g. a curb, can also disappear from the detection area of the sensors again before a continuous tone sounds. Loud sources of sound, inside and outside the vehicle, could drown out the PDC signal tone. ◀

 Keep the sensors clean and free of ice or snow in order to ensure that they will continue to operate effectively. Do not apply high pressure spray to the sensors for a prolonged period of time. Keep the spray at least 4 in/10 cm away from the sensors. ◀

## Driving stability control systems

Your BMW is equipped with an extended array of systems designed to enhance and maintain vehicle stability under extreme conditions. The following section describes these functions based on ABS, DSC, HDC and xDrive.

### Antilock Brake System ABS

ABS enhances active safety by preventing the wheels from locking under braking. The vehicle continues to be steerable during hard braking.

ABS also includes Electronic brake-force distribution EBV.

Safe braking, refer to page 77.

### Electronic brake-force distribution EBV

EBV controls the brake system's application pressure at the rear wheels to ensure stable deceleration.

### Dynamic Brake Control DBC

The Dynamic Brake Control actively supports the driver in dangerous braking situations. Quickly pumping the brake pedal increases the braking effect with low pedal pressure so that the shortest possible braking distance is achieved. This system exploits all of the benefits provided by ABS.

Do not reduce the pressure on the brake pedal for the duration of the brake application. DBC is deactivated when you release the brake pedal.

### Dynamic Stability Control DSC

#### The concept

DSC maintains vehicle stability, even in critical driving situations.

The DSC is operational every time you start the engine.

The system optimizes the driving stability during acceleration and when starting from a standstill. The system recognizes any tendency for the vehicle to assume an unstable attitude such as oversteer or understeer; it then counteracts this tendency with a combination of graduated reductions in engine torque and selective braking intervention at individual wheels. DSC provides optimal stability within the limits defined by the laws of physics.

 The laws of physics cannot be repealed, even with DSC. An appropriate driving style always remains the responsibility of the driver. Avoid using the additional safety margin provided by the system as an excuse for taking unnecessary risks.

Do not make any modifications to the DSC system. Never allow anyone other than authorized professional technicians to carry out service or repairs on the system. ◀

## Indicator lamp



The indicator lamp in the instrument cluster goes out soon after you start the engine.

If the indicator lamp flashes:

DSC is active and is regulating the drive and braking forces.

The indicator lamp stays lit:

DSC has been switched off using the button and the stabilizing interventions are no longer available.

## Switching off DSC



Press the button; the indicator lamp comes on and stays on.

Stabilizing interventions of the chassis control system DSC are no longer available. However, the braking interventions that simulate the function of the differential lock continue to be active.

In the following exceptional circumstances, it may be effective to switch off the DSC for a short period:

- ▷ When rocking the vehicle and starting off in deep snow or on loose road surfaces
- ▷ On sandy road surfaces
- ▷ On poor surfaces with deep ruts
- ▷ If the wheels churn on muddy surfaces
- ▷ When driving with snow chains.



As a result of the braking interventions, the brakes may be subjected to additional loads when the system is switched off. In order to limit the brake temperature, brief automatic masking of the brake activation is possible.

To maintain vehicle stability, always drive

with the system switched on when possible. ◀

## Switching DSC on

Press the DSC button again; the indicator lamp in the instrument cluster goes out. DSC is now activated.

## xDrive

xDrive is the all-wheel drive system of your BMW X3. The combined effects of xDrive and DSC further optimize the traction and dynamic driving characteristics. The all-wheel drive system xDrive variably distributes the drive torque to the front and rear axle depending on the driving situation and prevailing road conditions.

## Hill Descent Control HDC

### The concept

HDC is a system for hill descent assistance that reduces the speed on steep downward inclines and makes it even easier to control the driving characteristics of your BMW under these conditions.

The vehicle moves at slightly more than walking speed without active intervention from the driver.

HDC is available for activation at vehicle speeds below approx. 20 mph/35 km/h.

When driving down steep hills with a speed below approx. 20 mph/35 km/h, the vehicle reduces speed automatically down to slightly more than walking speed, approx. 5 mph/8 km/h, and then maintains this speed at a constant.

You can use the accelerator or brakes to vary this automatically controlled speed within a range extending from approx. 3 mph/5 km/h to 15 mph/25 km/h.

You can specify a target speed within the same range by using the +/- buttons of the cruise control in the steering wheel.

HDC is automatically deactivated once vehicle speed again exceeds approx. 35 mph/60 km/h.

## Activating the system



Press the button; the indicator lamp comes on.

The indicator lamp flashes when the brakes are applied automatically.

## Deactivating the system

Press the button again; the indicator lamp goes out.

Above approx. 35 mph/60 km/h HDC is immediately deactivated, and when the ignition is switched off after approx. 10 seconds.

## Using HDC

On manual transmission vehicles:  
Use HDC in first gear and in reverse gear, as in the higher gears the engine braking effect diminishes.

On automatic transmission vehicles:  
You can use HDC in every drive position.

## Malfunction

If the indicator lamp in the button goes out in the HDC mode or fails to light up when the button is pressed:

HDC is temporarily not available, as the brake temperature is too high.

## Malfunctions of the driving stability control systems



The red brake warning lamp lights up together with the warning lamps for ABS and DSC/xDrive. In addition, a warning signal sounds:



ABS, DSC and xDrive have failed. Drive may then only be carried out via the rear axle. Please have it



checked by the nearest BMW Sports Activity Vehicle Center.



Proceed cautiously and defensively. When driving on poor roads, refrain from using full throttle and avoid pressing the accelerator beyond the kickdown point. Otherwise the drive train may be damaged or accidents can occur. ◀

If the brake warning lamp lights up yellow in the described combination, the Electronic brake-force distribution EBV is still available.



Indicator and warning lamps for Canadian models.



The warning lamp in the instrument cluster lights up in yellow. Dynamic Brake Control DBC is defective. Have the system checked and repaired at your BMW Sports Activity Vehicle Center as soon as possible.



Warning lamp for Canadian models.



The warning lamp lights up continuously and a warning signal sounds: DSC or the xDrive all-wheel system has failed.

The stabilizing interventions of DSC or the all-wheel drive system xDrive are no longer available. Drive may then only be carried out via the rear axle. Please have it checked by the nearest BMW Sports Activity Vehicle Center.



Proceed cautiously and defensively. When driving on poor roads, refrain from using full throttle and avoid pressing the accelerator beyond the kickdown point. Otherwise the drive train may be damaged or accidents can occur. ◀



The warning lamp lights up: Malfunction in the driving stability control systems. HDC is no longer

available. See your BMW Sports Activity Vehicle Center to have the system repaired.

## Flat Tire Monitor

### The concept

The Flat Tire Monitor keeps track of the inflation pressures in the four fitted tires as you drive. The system provides an alert whenever the inflation pressure drops significantly in relation to the pressure another tire.

The check of the tire inflation pressure is based on monitoring the relative speeds of the wheels. A flat tire is detected and reported on the basis of a deviation in certain speed ratios.

### Functional requirement

So that the Flat Tire Monitor can learn the correct inflation pressure, please perform the following:

1. Check the inflation pressures in all tires
2. Compare with the inflation pressure table on page 87 and correct if necessary
3. Initialize the system.

### Limits of the system

 The Flat Tire Monitor cannot indicate sudden severe tire damage caused by outside factors and does not detect a natural, even pressure drop in all four tires. ◀

In the following situations, on the other hand, there can be delays in detecting tire pressure losses, and even system failure:

- ▷ When driving on snow-covered or slippery road surfaces
- ▷ In the case of performance-oriented driving: slip on the drive wheels, high lateral acceleration
- ▷ False alarms and undetected loss of pressure may occur when you are driving with snow chains fitted

- ▷ When driving with a compact wheel, the Flat Tire Monitor cannot operate.

### Initializing the system

 Perform the initialization immediately every time you correct the inflation pressure, change a tire or change a wheel or all wheels. A drive is required for this purpose. ◀

1. Before the start of driving, start the engine, but do not drive off



2. Press the button until the yellow indicator lamp in the instrument cluster lights up for a few seconds
3. Drive off.

It takes a few minutes until the Flat Tire Monitor can detect and indicated a flat tire.

 Do not initialize the system when driving with snow chains or with a compact wheel. ◀

### Flat tire

#### Indicator lamp

 The symbol in the instrument cluster lights up in yellow.

1. Reduce speed and stop the vehicle carefully. Avoid sudden braking and steering maneuvers
2. Identify damaged tire
  -  If identification is not possible, contact your BMW Sports Activity Vehicle Center. ◀
3. Replace the damaged tire, refer to Changing a wheel on page 103.



## Brake force display

The brake force display indicates the intensity with which you are applying your brakes to drivers of following vehicles.

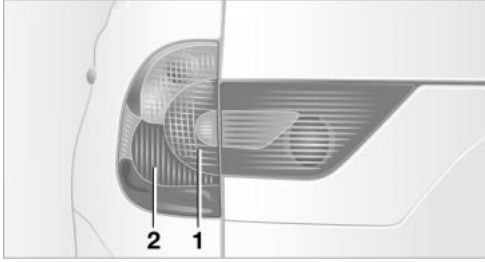

The display consists of two stages:

- ▷ Normal braking:  
Brake lamp 1 lights up on both sides of the vehicle together with the center brake lamp
- ▷ Heavy braking and braking with ABS:  
Brake lamps 1 and 2 light up on both vehicle sides together with the center brake lamp.

## Airbags

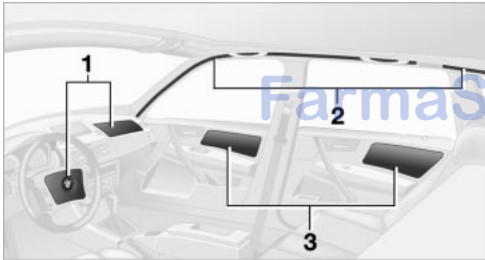

The following airbags are located beneath the marked covers:

- 1 Front airbags for driver and front passenger
- 2 Head airbags in front and rear
- 3 Side airbags in front and rear\*

### Protective effect

The front airbags help protect the driver and front passenger by responding to frontal impacts in which safety belts alone can-

not provide adequate restraint. When needed, the head and side airbags help provide protection in the event of side impact. The relevant side airbag supports the side upper body area. The relevant head airbag supports the head and provides protection against objects entering the vehicle.

The airbags are deliberately not triggered in every impact situation, e.g. less severe accidents, certain roll-over situations or rear-end collisions.

 The rear seat side airbags may already have been deactivated by a BMW Sports Activity Vehicle Center. Labels in the rear door opening should indicate the status of your rear seat side airbags. If you are uncertain of their status, or wish to have the airbags activated or deactivated, please contact your BMW Sports Activity Vehicle Center. ◀

For information on the correct sitting position, refer to page 27.

 Do not apply adhesive materials to the cover panels of the airbags, cover them or modify them in any other way.

Do not attempt to remove the airbag retention system from the vehicle. Never modify or tamper with either the wiring or the individual components in the airbag system.

This category includes the upholstery in the center of the steering wheel, on the instrument cluster, the side trim panels on the doors, and the roof pillars along with the sides of the headliner. Do not attempt to remove or dismantle the steering wheel. Do not touch the individual components directly after the system has been triggered, because there is a danger of burns.

If you note any indication of system malfunction, if you desire to have an airbag deactivated, or if the airbag retention system is triggered in response to an accident, you should always entrust all inspection, repair and dismantling operations to your BMW Sports Activity Vehicle Center.

Unprofessional attempts to service the system could lead to failure in an emergency or undesired airbag activation, either of which could result in personal injury.



To ensure compliance with official safety regulations, please also entrust disposal of airbag generators to a BMW Sports Activity Vehicle Center. ◀

Airbag warning information is also provided on the sun visors.

### Automatic deactivation of the front passenger airbags

Your BMW has a seat occupation detection system. By evaluating the weight on the front passenger's seat, the system detects whether or not the seat is occupied by a child in the child-restraint system or an adult.

- ▶ When a child is seated in the child-restraint system or with an empty seat, the front and side airbags are deactivated on the passenger's side
- ▶ When an adult is traveling in the front seat, the front and side airbags remain active on the passenger side.

 With heavier children, the front passenger airbags can remain active, or with very light adults or teenagers the front passenger airbags can be deactivated unintentionally.

The condition of the front passenger airbags is indicated via the telltale lamp, refer to Indicator lamps in the following. In this case transport the corresponding persons on the rear seat.

Except when persons to be transported, do not increase the load on the front passenger seat with additional items. Do not fit seat covers, seat cushion padding, ball mats or other items to the front passenger seat unless they are specifically recommended by BMW. Do not place any items under the seat. Otherwise, the function of the seat occupation detection could be impaired. ◀

## Indicator/warning lamp

### Airbag system operational

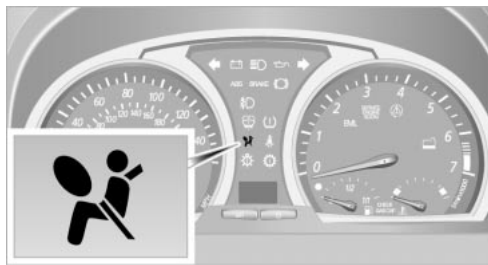

The airbag indicator lamp in the instrument cluster indicates the operational readiness of the entire airbag system and the safety belt tensioners as of ignition key position 1. The indicator lamp goes out after a few seconds.



The telltale lamp above the interior rearview mirror indicates whether the passenger airbag system is activated or deactivated as of ignition key position 1.

- ▶ The telltale lamp refers exclusively to the passenger airbag system. ◀
  - ▶ The telltale lamp goes out after a few seconds. The front passenger airbags are active, e.g. when transporting an adult
  - ▶ The telltale lamp lights up continuously. The front passenger airbags are deactivated, e.g. when a child is traveling in the vehicle in the child-restraint system or when the seat is empty.

For more information on the operating principle of the front passenger airbag system and seat occupation detection, refer to Automatic deactivation of the front passenger airbags.

### Airbag system malfunction



A system malfunction could prevent the system from responding in the expected manner to an impact occurring within its normal response range.

Please have the airbag system checked immediately by a BMW Sports Activity Vehicle Center. ◀



There is a fault in the airbag system if the airbag indicator lamp in the instrument cluster behaves as follows:

- ▷ Indicator lamp does not light up as of ignition key position 1
- ▷ Indicator lamp remains lit continuously
- ▷ Indicator lamp lights up while the vehicle is being driven.

امداد خودرو فارما

تلفن شبانه روزی: ۰۸۵-۸۸۸۶۲-۰۲۱

FarmaSOS.com

# Lamps

## Parking lamps/low beams

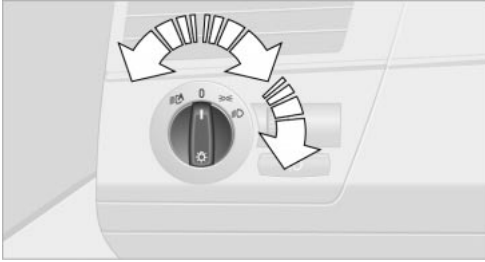

### Parking lamps

 The front, rear and side vehicle lighting is switched on. You can use the parking lamps for parking. For lighting on one side for parking as an additional feature, refer to page 58.

### Low beams

 When you switch on the ignition with the headlamps on, the headlamps go out and only the parking lamps remain on.

### Lamp defective

 The indicator lamp lights up: At least one bulb of the exterior lighting on the vehicle is defective.

Replacing the bulbs, refer to page 99.

### Pathway lighting

When you activate the headlamp flasher after parking the vehicle and switching off the lamps, the low beams will come on for a brief period.

 You may also have this function deactivated if you wish. ◀

### Lights on warning

If you turn the ignition key to position 0, an acoustic signal sounds when you open the driver's door for a few seconds to remind you that the light has not yet been switched off.

## Daytime driving lamps\*

You can leave the light switch in the second position: all external lamps go out when you switch off the ignition.

Always observe all applicable laws governing the use of daytime driving lamps.

You can switch on the parking lamps when needed using the standard procedure described under Parking lamps.

 You can have the daytime driving lamp circuit activated on your vehicle. ◀

## Automatic headlamp control\*

 When you set the switch to this position, the system activates and switches on and off the low beams in response to changes in ambient light conditions, for instance, in tunnels, at dawn and dusk, and in rain and snow.

 Following automatic activation the vehicle's external lighting remains on when you switch on the fog lamps. ◀

 Automatic headlamp control cannot serve as a substitute for the driver's judgment in determining when the vehicle lamps should be switched on. For example, the system cannot detect fog. To avoid safety risks, you should always switch on the lamps manually under these conditions. ◀

 You can have the sensitivity of the headlamp control adjusted. ◀

## Adaptive Head Light\*

### The concept

Adaptive Head Light is a variable headlamp control system that enables dynamic illumination of the road surface. Depending on the steering angle and other assumptions, the light from the headlamp follows the course of the road.

### Activating the Adaptive Head Light



In ignition key position 2, turn the light switch to the position 'Automatic headlamp control'.



When the vehicle is backing up, the Adaptive Head Light is inactive; when the vehicle is at a standstill, it is only active in one direction. ◀

### Malfunction

The LED above the symbol for automatic headlamp control flashes. Please have it checked by your BMW Sports Activity Vehicle Center.

### Instrument lighting

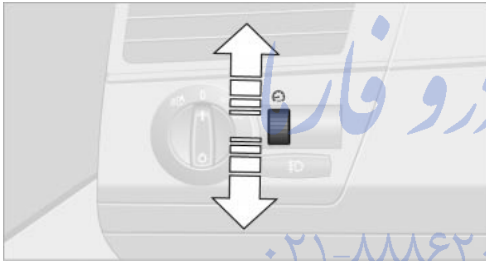

Turn the serrated dial to adjust the illumination intensity.

### Standing lamps, left or right\*

You also enjoy the option of lighting up just one side of your vehicle when parking. When using this function, comply with national regulations:

In ignition key position 0 or with ignition key removed:

Allow the lever to engage in the corresponding turn signal indicator position.

### Fog lamps\*



A green indicator lamp appears in the instrument cluster to indicate that the front fog lamps are on.



If the automatic headlamp control is activated, the low beams will come on automatically when you switch on the fog lamps. ◀

### High beams/standing lamps

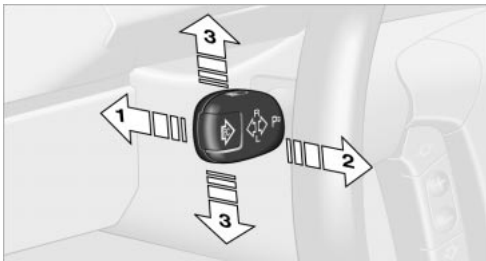

- 1 High beams – blue indicator lamp
- 2 Headlamp flasher – blue indicator lamp
- 3 Standing lamps

### Interior lamps



The interior lamps operate automatically.



If you desire, the interior lamps are switched on after mechanical unlocking of the vehicle. You may have this function activated/deactivated if you wish. ◀

## Switching the interior lamps on and off

Briefly press button 1.

If you want the interior lamps to remain off all the time, press and hold the button for approx. 3 seconds.

Press the button briefly to revert to normal operation.



You can have soft dimming of the interior lamps set. ◀

## Front reading lamps\*

Switch on and off with the buttons 2.

## Rear reading lamps\*

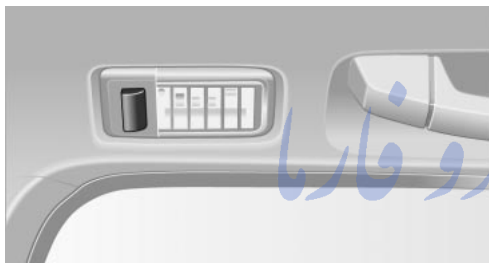

Switch on and off with the button.

تلفن شبانه روزی: ۰۸۵-۸۸۶۲۰۲۱

FarmaSOS.com

# A congenial climate

## Air conditioner

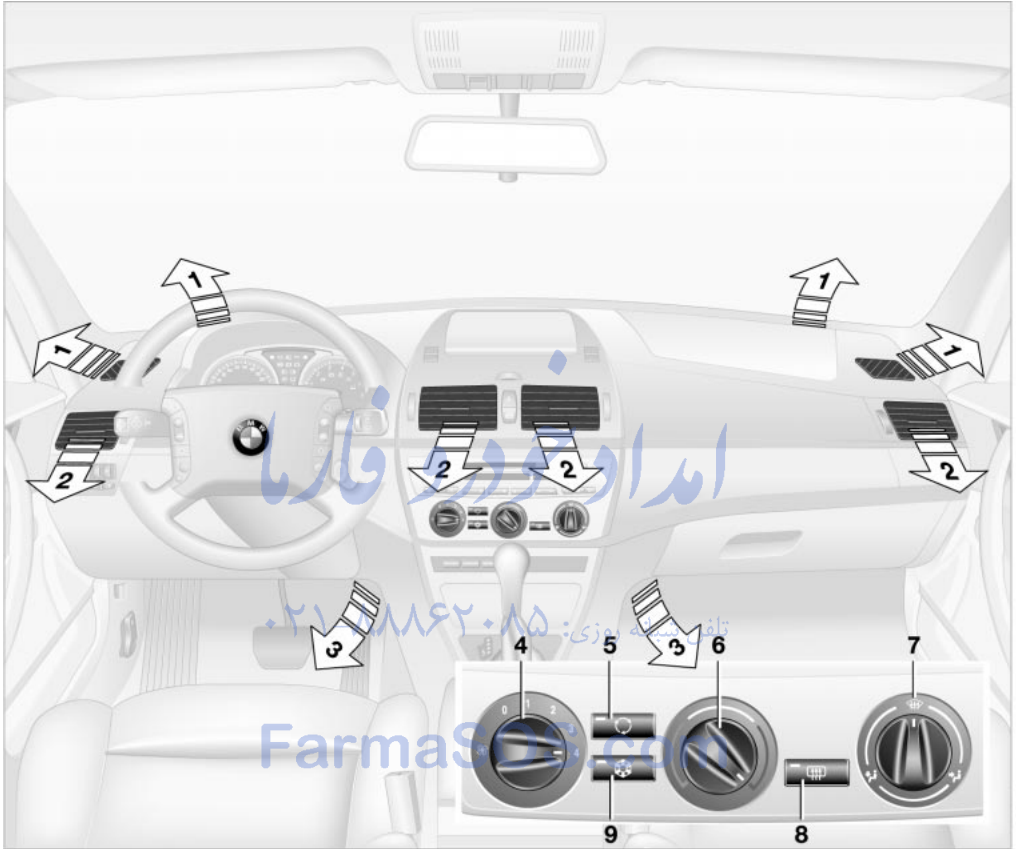

- |   |   |   |                                      |
|---|---|---|--------------------------------------|
| 1 | Airflow directed toward the windshield and side windows | 5 | Outside air/recirculated-air mode 61 |
| 2 | Airflow for the upper body 61                           | 6 | Temperature 61                       |
| 3 | Front footwell ventilation 61                           | 7 | Air distribution 61                  |
| 4 | Air supply/blower 61                                    | 8 | Rear window defroster 61             |
|   |   | 9 | Air conditioner 61                   |

## Air supply/blower



You can select blower speeds 1 to 4. The heating and ventilation become more and more effective as the air supply settings are increased. In position 0, the blower and heater are switched off. The air supply is blocked in position 0.





## Temperature



To increase the temperature of the interior, turn to the right.

## Air distribution



You can direct air to flow onto the windows , toward the upper body  and into the footwell . All intermediate settings are possible. In the  setting, there is a low flow of air onto the windows to keep them free of condensation.

## Rear window defroster



When the rear window defroster is activated, the indicator lamp comes on.

The rear window defroster switches off automatically.



You can have your vehicle programmed in such a way that the rear window defroster switches on automatically. It is then switched on at outside temperatures of less than approx. +4 °C/39 °F within 5 minutes of the engine start. ◀

## Air conditioning



The air is cooled and dehumidified and – depending on the temperature setting – warmed again. Depending on the weather, the windshield may fog over briefly when the engine is started. You can reduce condensation forming on the windows by switching on the air conditioning.



During air conditioning condensation forms, which then exits under the

vehicle. Traces of condensed water of this kind are thus normal. ◀

## Outside air/recirculated-air mode



You can respond to unpleasant odors outside the vehicle by temporarily switching off the outside air supply. The system then recirculates the air currently within the vehicle.



If condensation starts to form on the inside window surfaces during operation in the recirculated-air mode, you should switch it off while also increasing air supply as required. The recirculated-air mode should not be used over a sustained longer period of time, as the air quality inside the vehicle deteriorates. ◀

## Ventilation

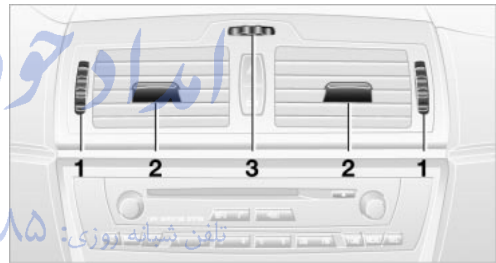

The air vents for the upper body area can be adjusted:

- 1 Serrated dials 1 for steplessly opening and closing the air vents
- 2 Selector levers for airflow direction
- 3 Use the serrated dial 3 to adjust the amount of cool air that is added to the airflow emerging from the vent outlets for the upper body

## Ventilation for cooling

Adjust the vents to direct the flow of cool air in your direction, for instance, if the interior has become too warm, etc.

## Draft-free ventilation

Set the vent outlets so that the air flows past you and is not directed straight at you.

## Microfilter

The built-in microfilter removes dust and pollen from the incoming outside air. It is replaced when maintenance is performed by your BMW Sports Activity Vehicle Center. A substantial reduction in air supply indicates that the filter must be replaced before normal maintenance.

## Defrosting windows and removing condensation

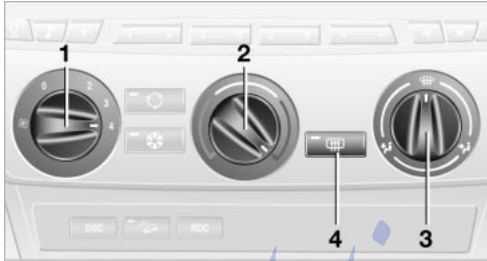

- 1 Fan blower rotary switch for air supply at setting 4
- 2 Turn the rotary temperature switch as far to the right as it will go
- 3 Rotary switch for air distribution in position 
- 4 Switch on the rear window defroster to defrost the rear window

امداد خودرو فارما

تلفن شبانه روزی: ۰۲۱-۸۸۸۶۲۰۸۵

FarmaSOS.com



## Automatic climate control\*

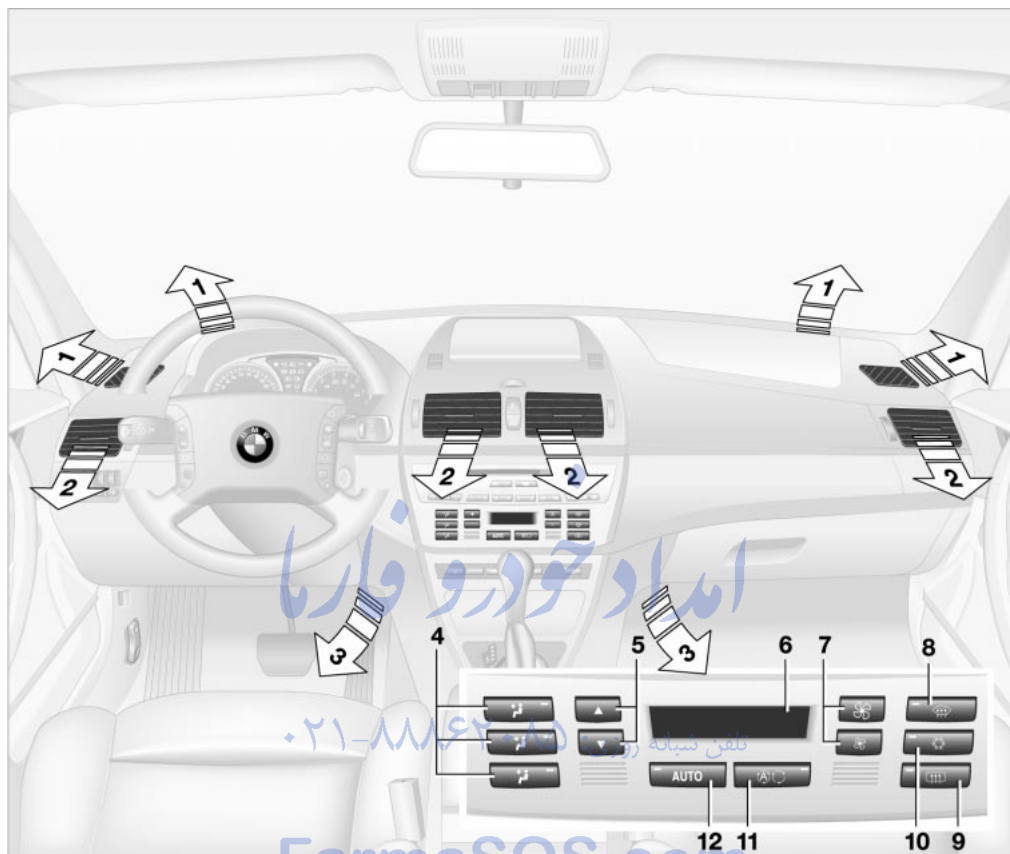



- 1 Airflow directed toward the windshield and side windows
- 2 Airflow for the upper body 65
- 3 Air to footwell 65
- 4 Individual air distribution 64
- 5 Temperature 64
- 6 Display for temperature 64 and air supply 64
- 7 Air supply/blower 64
- 8 Defrosting windshield and windows and removing condensation 64
- 9 Rear window defroster 65
- 10 Air conditioner 64
- 11 Outside air/AUC Automatic recirculated-air control/Recirculated-air mode 64
- 12 Automatic air distribution and supply 64

## A congenial climate

Use the automatic facility by operating the AUTO button 12. Select an interior temperature that is comfortable for you.

Detailed setting options are described for you in the following section.





 Your vehicle has been designed to automatically select your personal climate-control settings whenever you unlock the doors using your individually programmed remote control. ◀

 If you want, you can have this function deactivated. ◀



## Automatic air distribution and supply

 The AUTO program adjusts the airflow and distribution patterns for you while also using your preselected temperature setting as the basis for adjusting the interior climate to adapt to external influences – summer, winter.

## Individual air distribution

 You can cancel the AUTO program by selecting specific air distribution patterns for your personal comfort, the automatic air supply remains in operation. You can direct air to flow onto the windows , toward the upper body , and into the footwell . You can reactivate the automatic air distribution mode by selecting the AUTO button.

## Temperature

  The figures in the display provide a general indication of interior temperature. When you start the vehicle, this system ensures that the selected temperature is achieved as quickly as possible. It then maintains this temperature, regardless of the season.

## Air supply/blower

 You can vary the air supply by pressing the upper or lower button. This switches off the automatic program for the air supply, and the word AUTO goes out in the display. The automatic mode for air distribution remains in operation as before. You can reactivate the automatic air supply mode by selecting the AUTO button.

If you press the lower button when at the lowest blower speed, all displays go out: the blower, heating and air conditioner are switched off. The outside air supply is closed. You can restart the automatic climate control by pressing any of its buttons.

## Defrosting windows and removing condensation

 This program quickly removes ice and condensation from the windshield and door windows.

## Air conditioner

 The air is cooled and dehumidified and – depending on the temperature setting – warmed again. Depending on the weather, the windshield may fog over briefly when the engine is started. The window mist is reduced during A/C operation.

The air conditioner comes on automatically when you select the AUTO program.

 During air conditioning condensation forms, which then exits under the vehicle. Traces of condensed water of this kind are thus normal. ◀

## Outside air/AUC Automatic recirculated-air control/ Recirculated-air mode

 You can respond to unpleasant odors or pollutants in the immediate environment by temporarily suspending the supply of outside air. The system then recirculates the air currently within the vehicle. Press the button

repeatedly to run through the following control sequence:

- ▷ Indicator lamps off: outside air flows into the vehicle
- ▷ Left-hand indicator lamp on – AUC mode: the system recognizes pollutants in the outside air and blocks the flow of air when necessary. The system then recirculates the air currently within the vehicle.

Depending on the air quality, the automatic system then switches back and forth between outside air supply and recirculation of the air within the vehicle

- ▷ Right-hand indicator lamp on: the outside air supply into the vehicle is completely blocked. The system then recirculates the air currently within the vehicle.

 If condensation starts to form on the inside window surfaces during operation in the recirculated-air mode, you should switch it off while also increasing air supply as required. The recirculated-air mode should not be used over a sustained longer period of time, as the air quality inside the vehicle deteriorates. ◀

### Rear window defroster



When the rear window defroster is activated, the indicator lamp comes on.

The rear window defroster switches off automatically.



You can have your vehicle adjusted in such a way that the rear window defroster switches on automatically. It is then switched on at outside temperatures of less than approx. +4 °C/39 °F within 5 minutes of the engine start. ◀

## Ventilation

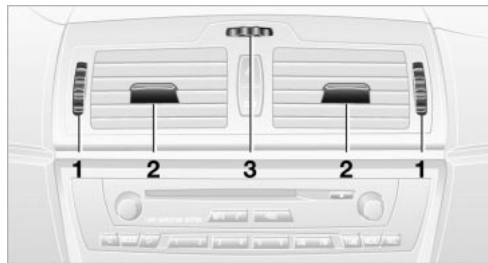

The air vents for the upper body area can be adjusted:

- 1 Serrated dials for opening and closing the vent outlets through an infinitely-variable range
- 2 Selector levers for airflow direction
- 3 Use the serrated dial 3 to adjust the amount of cool air that is added to the airflow emerging from the vent outlets for the upper body

### Ventilation for cooling

Adjust the vents to direct the flow of cool air in your direction, for instance, if the interior has become too warm, etc.

### Draft-free ventilation

Set the vent outlets so that the air flows past you and is not directed straight at you.

### Microfilter/activated-charcoal filter\*

The built-in microfilter removes dust and pollen from the incoming air. The activated-charcoal filter provides additional protection by filtering gaseous pollutants from the outside air. This combined filter is replaced when maintenance is performed by your BMW Sports Activity Vehicle Center. A substantial reduction in air supply indicates that the filter must be replaced before normal maintenance.

# Practical interior accessories

## Integrated universal remote control\*

### The concept

The integrated universal remote control replaces up to three different hand-held transmitters for various items of radio-controlled equipment such as door openers and house alarm systems. The integrated universal remote control recognizes and learns the transmitted signal of each of the original hand-held transmitters.

The signal of an original hand-held transmitter can be programmed on one of the three memory buttons **1**. Following that, each of the devices can be actuated with the appropriately programmed memory button **1**. The indicator lamp **2** flashes to confirm transmission of the signal.

If the vehicle is sold, the memory of the memory buttons **1** should be cleared, refer to page [67](#).

 To prevent possible damage or injury, before programming or using the integrated universal remote control, always inspect the immediate area to make certain that no people, animals or objects are within the travel range of the device. Also, comply with the safety precautions of the original hand-held transmitter. ◀

### Checking the compatibility



If you see this symbol on the packaging or in the manual supplied with the original hand-held transmitter, it is safe to assume that it is compatible with the integrated universal remote control.



If you have additional questions, please consult your BMW Sports Activity Vehicle Center or call 1-800-355-3515.

You can also visit these websites:  
[www.bmwusa.com](http://www.bmwusa.com) or  
[www.homelink.com](http://www.homelink.com).

HomeLink is a registered trademark owned by Johnson Controls, Inc. ◀

### Programming

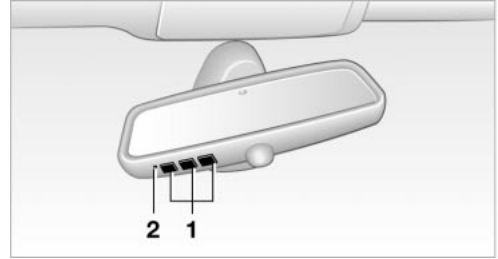

- 1** Memory buttons
- 2** Indicator lamp

### Fixed-code hand-held transmitter

1. Turn the ignition key to position 2
2. For initial use:  
 Press both outer buttons **1** for approx. 20 seconds, maintaining pressure until the indicator lamp **2** starts to flash. The three memory buttons **1** are cleared
3. Hold the original hand-held transmitter at a distance of approx. 2 in/5 cm to 8 in/20 cm to the memory buttons **1**
  -  The required distance between the hand-held transmitter and memory keys **1** depends on the relevant system of the original hand-held transmitter used. ◀
4. Simultaneously press the transmit button on the original hand-held transmitter and the desired memory key **1** of the integrated universal remote control. Initially, the indicator lamp **2** flashes slowly. Release both buttons as soon as the indicator **2** lamp flashes rapidly. If the indicator lamp **2** does not flash rapidly after approx. 15 seconds, change the distance
5. To program other original hand-held transmitters, repeat steps 3 and 4.

The corresponding memory button 1 is now programmed with the signal of the original hand-held transmitter.

The equipment can be used as of ignition key position 2.

 If the device cannot be operated after repeated programming, check whether the original hand-held transmitter uses an alternating-code system. To do so, either read the instructions of the original hand-held transmitter or press and hold down the programmed memory button 1 of the integrated universal remote control. If the indicator lamp 2 on the integrated universal remote control flashes rapidly for a short time then lights up for approx. 2 seconds, this indicates that the original hand-held transmitter uses an alternating-code system. In the case of an alternating-code system, program the memory buttons 1 as described at the section on alternating-code transmitters. ◀

### Alternating-code transmitters

Consult the operating instructions of the unit you wish to set when programming the universal remote control. You will find information there on the possibilities for synchronization.

When programming hand-held transmitters that employ an alternating code, please observe the following supplementary instructions:

 Programming will be easier with the aid of a second person. ◀

1. Park your vehicle within the range of the remote-controlled device
2. Program the integrated universal remote control as described above at Fixed-code hand-held transmitters
3. Locate the button at the receiver of the equipment to be set, e.g. on the drive
4. Press the button on the receiver of the device you want to set up. After step 4, you have approx. 30 seconds for step 5
5. Press the programmed memory button 1 of the integrated universal remote control three times.

The corresponding memory button 1 is now programmed with the signal of the original hand-held transmitter.

 If you have questions, please contact your BMW Sports Activity Vehicle Center. ◀

### Clearing the memory buttons

Press both outer buttons 1 of the integrated universal remote control for approx. 20 seconds, maintaining pressure until the indicator lamp 2 starts to flash. All three memory buttons are cleared.

The memory of individual memory buttons 1 cannot be cleared.

## Beverage holders

### Front



Depending on your optional equipment, the center console contains either one or two beverage holders.

### Passenger's side\*

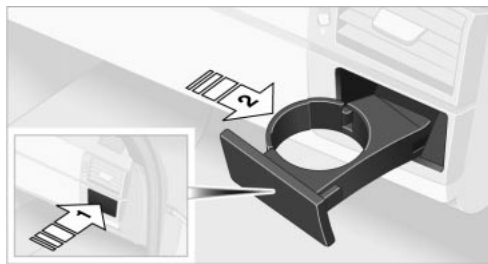

The beverage holder for the front passenger is located beneath the air/heating vent.

1. Press the trim piece below the air/heating vent, arrow 1
2. Insert beverage
3. Adapt the holding arm to the size of the beverage container, refer to arrow 2.

 If you only hand over the spare key, e.g. in a hotel for valet parking, refer to page 18, the glove compartment cannot be accessed. ◀

### Rear

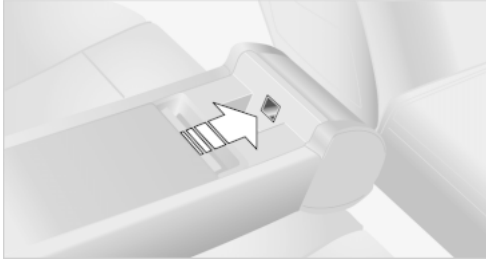

A beverage holder is located in the center armrest at the rear:  
Press the button to open.

## Storage compartments

### Front center armrest\*



The center armrest contains two storage compartments.

- ▷ CD storage compartment:  
Press button 1
- ▷ Coin and oddments compartment:  
Press button 2.

## Glove compartment

### Opening

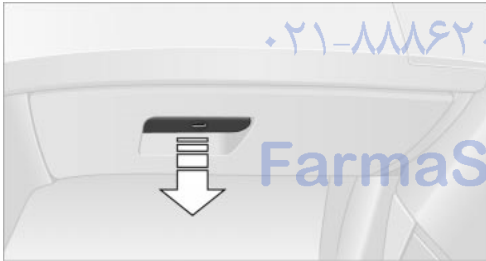

Pull the handle. The lamp inside the glove compartment comes on.

### Rear center armrest



A storage compartment holder is located in the center armrest at the rear:

To open, pull the cover upward.

### Closing

Fold the cover up.

 To prevent injury in the event of an accident, close the glove compartment immediately after use. ◀

### Locking

Use one of the master keys. A master key is also required for unlocking.

### Storage package\*

Your convenience is enhanced by:

- ▷ Sliding lashing eyes in luggage compartment, refer to page 73
- ▷ Floor cover in luggage compartment that can be used on both sides, refer to page 72

- ▷ Nets in the luggage compartment and on the rear of the front seats.

## Sockets

You will find additional power outlets in the cargo area, refer to page 73.

## Front ashtray\*

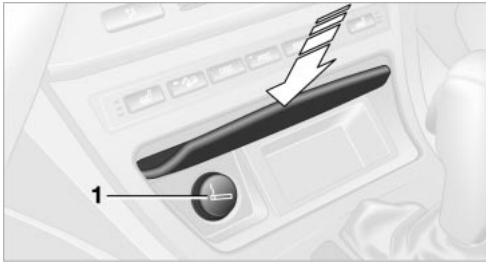

Press the edge of the opened cover:  
The ashtray moves up and can be removed.

On vehicles with the non-smoking package, the insert is removed in the same way.

## Ashtray, rear\*

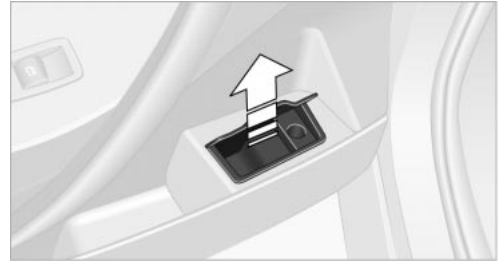

Remove the insert tray.

## Cigarette lighter, front\*

Press the lighter 1 in.

The lighter can be removed as soon as it retracts.

**⚠** Hold or touch the hot cigarette lighter by the knob only. Holding or touching it in other areas could result in burns. The cigarette lighter remains operational when the ignition key has been removed. For this reason, do not leave unsupervised children in the vehicle. ◀

## Lighter socket

The socket can be used to plug in hand flashlights, car vacuum cleaners, etc., with power ratings of up to approx. 200 W at 12 V. Avoid damage to the socket caused by inserting plugs of a different shape or size.

## Non-smoking package

On vehicles with the non-smoking package, the socket is located in the same position.

Access to the socket: lift off cap.

## Cigarette lighter, rear\*



Depending on your optional equipment, the lighter can be located on the top or end face of the center console.

Press the lighter in.

The lighter can be removed as soon as it retracts.

**⚠** Hold or touch the hot cigarette lighter by the knob only. Holding or touching it in other areas could result in burns. The cigarette lighter remains operational when the ignition key has been removed. For this reason, do not leave unsupervised children in the vehicle. ◀



## Car phone preparation\*

### Hands-free system



On vehicles with car phone preparation\* the hands-free microphone is located on the headliner near the interior lamp.

For more information on the car phone, refer to Owner's Manual for Telephone.

### Ski bag\*

The ski bag allows the safe and clean transport of up to four pairs of standard skis or up to two snowboards.

The ski bag itself plus the additional capacity provided by the luggage compartment make it possible to transport skis with a length of up to 2.10 m. When skis of 2.10 m in length are loaded the ski bag will tend to contract, reducing its overall capacity.

### Loading

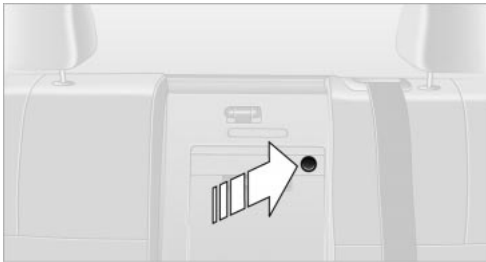

1. Pull down the center armrest, press the button and take out the cover
2. Press the button again; the cover in the luggage compartment opens. If you press the button firmly the first time, this

also opens the cover in the luggage compartment

3. Extend the ski bag between the front seats. The zipper allows more convenient access to stored objects and can also be left open to allow the ski bag to dry

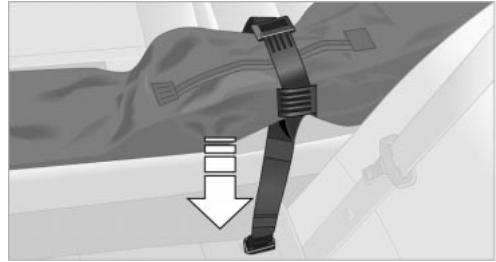

4. Insert the belt tongue of the ski bag belt in the center safety belt buckle.

Please ensure that the skis are clean before loading them into the bag. Take care to avoid damage from sharp edges.

### Securing the load

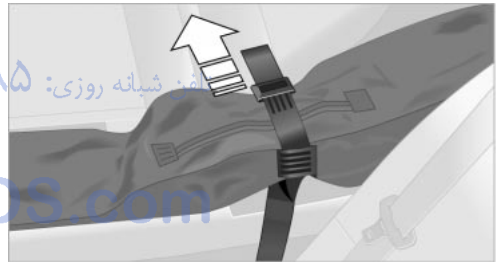

Secure the bag's contents by tightening down the strap at the buckle.

**!** Secure the ski bag in this way. If you fail to do so, it could move around and endanger occupants during braking or evasive maneuvers. ◀

To store the ski bag, perform the above steps in reverse order.



## Removing the ski bag



Pull the handle forward and remove the ski bag upward.

**⚠** Do not position cargo at the opening. If you do, it can endanger the passengers during braking or evasive maneuvers. ◀

## Cargo area cover

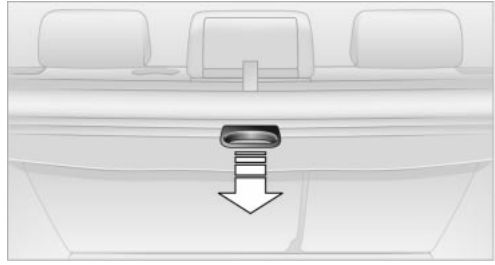

Pull the cargo area cover out by the handle and hook it in the rear holders.

You can carry light objects such as articles of clothing on the cargo area cover.

**⚠** Do not place heavy and hard objects on the cover. If you do so, they could endanger occupants during braking maneuvers. Do not allow the cover to snap back into place, as otherwise it could be damaged. ◀

## Cargo area

When loading, observe the information on page 78.

## Folding rear seat back

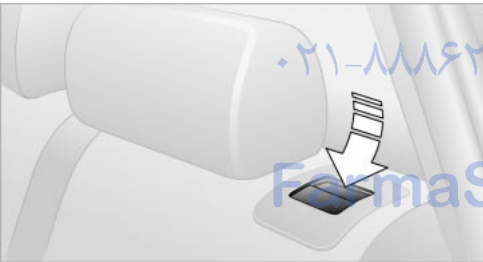

Reach into the opening and pull forward, refer to arrow.

**⚠** When you fold back the backrest, be sure that the catch engages securely. The red warning indicator disappears in the recess when the catch is engaged. ◀

## Ski bag\*

To create a flat load area floor, you can remove the ski bag before folding the rear seat back and replace it with a cover. You will find the cover in the cargo area under the floor cover.

## Removal

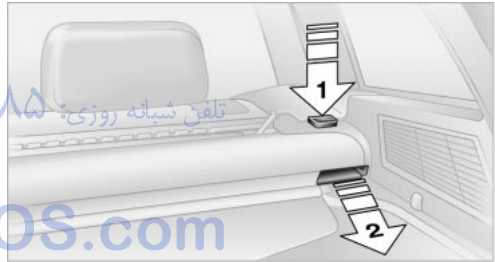

1. Press the side buttons, refer to arrow 1
2. Pull the cassette towards the rear, refer to arrow 2.

## Installation

Push the cassette forward into the two side holders until it locks in place.

### Loading cargo with the rear seat back folded down

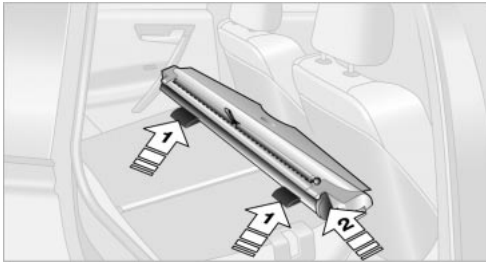

Holders for the cassette are fitted to the backs of the rear seat backs, refer to arrow 1.

Guide in the cassette from the right side until it locks in place, refer to arrow 2. Here, the cargo area cover must always point in the direction of travel and the loop of the partition net must point upward.

You can pull out the partition net and insert it in the holders in the roof area above.

#### Partition net\*

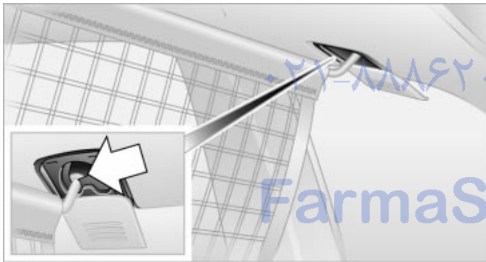

Pull the partition net by the loop from the cassette; hold the bar on both sides and insert in the holder.

**⚠** Do not allow the partition net to snap back into place, as otherwise there is a danger of injury and the partition net could be damaged. ◀

### Behind the side trim panel

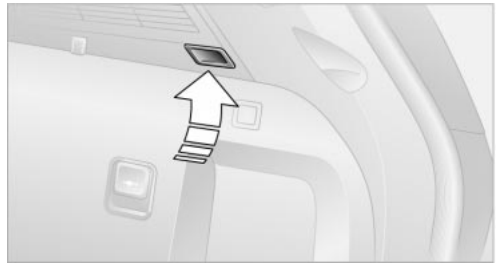

Press the button to open.

### Floor cover

#### Opening

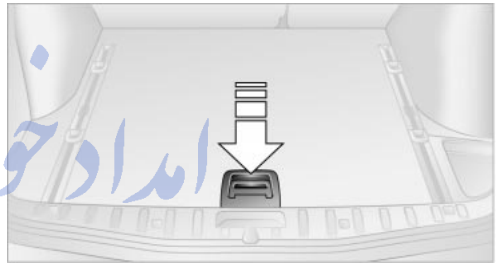

For access to the compact wheel etc. To open, raise the cover by the handle, refer to arrow.

If required, you can remove or raise the floor cover.

#### Raising



Swing up the floor cover and hook it onto the handle of the cargo area cover with its catch.

## Lashing eyes, rail\*



You can secure load-securing devices to the lashing eyes on the cargo area floor. To shift the lashing eyes, press the button. The lashing eyes can be removed at the openings in the rails.

 Read and comply with the information enclosed with the load-securing devices. ◀

## Sockets



When the cover is folded up, you have access to another socket.

The sockets can be used to plug in hand flashlights, car vacuum cleaners, etc., with power ratings of up to approx. 200 W at 12 V. Do not damage the socket with unsuitable plugs, also refer to page 69.



# امداد خودرو فارما

تلفن شبانه روزی: ۰۲۱-۸۸۸۶۲۰۸۵

[FarmaSOS.com](http://FarmaSOS.com)

## Driving tips

This section is designed to provide you with extra support by supplying information useful in dealing with specific driving and operating conditions.

امداد خودرو فارما

تلفن شبانه روزی: ۰۲۱-۸۸۸۶۲۰۸۵

FarmaSOS.com

# Things to remember when driving

## Break-in procedures

To ensure that your vehicle provides maximum economy throughout a long service life, we request that you observe the following instructions:

### Engine and differential

Up to 1,200 miles/2,000 km:

During this initial period you should attempt to avoid constant, steady-state operation and vary both vehicle and engine speeds as often as possible. Until the break-in period has been completed you should also refrain from exceeding the following:

- ▷ 4,500 rpm or 100 mph/160 km/h.

Always obey all official speed limits.

Refrain from using full throttle and avoid pressing the accelerator beyond the kick-down point.

Once you have driven 1,200 miles/2,000 km, the engine and vehicle speeds can be gradually increased.

You should also comply with these break-in procedures should the engine or one of the differentials be replaced later in the course of the vehicle's service life.

### Tires

Due to technical factors associated with their manufacture, tires do not achieve their full traction potential until after an initial break-in period. For this reason, drive with extra care during the initial 200 miles/300 km.

Obey your local and state maximum speed limits.

 When the vehicle is operated on wet or slushy roads, a wedge of water may form between the tire and the road surface. This phenomenon is referred to as hydroplaning and can lead to partial or complete loss of traction, vehicle control and braking effectiveness. Reduce your speed on wet roads. ◀

## Brake system

Approx. 300 miles/500 km must elapse before the brake pads and rotors achieve the optimal pad-surface and wear patterns required for trouble-free operation and long service life later on.

To break in the separate handbrake drums, apply the handbrake lightly when coasting to a standstill – at a traffic signal, for instance; use caution to avoid posing a danger to other road users.

To avoid corrosion, repeat this procedure from time to time.

The brake lamps do not come on when the handbrake is set.

 Vacuum for the brake system servo unit on your BMW is available only when the engine is running. When you move the vehicle with the engine off – e.g. by towing – substantially higher levels of pedal force will be required to brake the vehicle. ◀

## Clutch

The function of the clutch is also only at its optimized level after a distance driven of approx. 300 miles/500 km. During this break-in period, engage the clutch gently.

## General driving notes

### High temperatures

 Extreme temperatures occur at the catalytic converter on this and every catalyst-equipped vehicle. Do not remove the heat shields installed adjacent to various sections of the exhaust system, and never apply undercoating to them. When driving, standing at idle and while parking take care to avoid possible contact between the hot exhaust system and any highly flammable materials such as hay, leaves, grass, etc. Such contact could lead

to a fire, and with it the risk of serious property damage as well as personal injury. ◀

## Parking the vehicle

Condensation forms in the air conditioner system during operation, and then exits under the vehicle. Traces of condensed water under the vehicle are thus normal.

## Before driving into the car wash

Fold in the exterior mirrors, refer to page 31, as otherwise they could be damaged due to the width of the vehicle. Deactivate the rain sensor as otherwise damage could result from undesired wiper activation, refer to page 42.

## Hydroplaning

 When driving on wet or slushy roads, reduce road speed. If you do not, a wedge of water can form between tires and road surface. This phenomenon is referred to as hydroplaning, and is characterized by a partial or complete loss of contact between tires and road surface, ultimately undermining your ability to steer and brake the vehicle. ◀

## Driving through water

 Do not drive through water on the road if it is deeper than 20 in/50 cm, and then only at walking speed. Otherwise, the vehicle's engine, the electrical systems and the transmission may be damaged. ◀

## Safe braking

### Emergency stops

The best way to brake is to apply maximum pressure to the brake pedal during emergency – panic stops. Since the vehicle maintains steering responsiveness, you can nevertheless avoid possible obstacles with a minimum of steering effort.

Pulsation at the brake pedal combined with sounds from the hydraulic circuits indicates to the driver that ABS is in its active mode.

 Do not drive with your foot resting on the brake pedal. Otherwise, even light but consistent pedal pressure can lead to high temperatures, brake wear and possibly even brake failure. ◀

## Wet conditions

While driving in wet conditions and in heavy rain, it is a good idea to apply light pressure to the brake pedal every few miles. Watch traffic conditions to ensure that this maneuver does not endanger other road users. The heat which is generated by the brake applications helps to dry the brake pads and rotors. The required braking force will then be available when you need it.

## On a grade

You can retain full and unimpaired braking efficiency by downshifting to a gear in which only minimal brake applications are needed when descending long or steep downhill stretches.

You can further enhance the engine's braking effect by selecting a lower gear in the automatic transmission's manual mode, downshifting as far as first gear on extremely steep stretches, refer to page 38. This strategy helps you avoid placing excessive loads on the brake system.

During slower downhill driving, use the Hill Descent Control HDC, refer to page 51.

 Never drive with the clutch pressed, with the transmission in Neutral or with the engine switched off, as otherwise there is no engine braking when the transmission is in Neutral, and no power-assist for brakes and steering. Never allow floor mats, carpets or any other objects to protrude into the area around the accelerator and brake pedals and obstruct their movement. ◀

## Corrosion

When the vehicle is driven only occasionally, during extended periods when the vehicle is not used at all, and in operating conditions where brake applications are



less frequent, there is an increased tendency for corrosion to form on rotors, while contaminants accumulate on the brake pads. This occurs because the minimal pressure which must be exerted by the pads during brake applications to clean the rotors is not reached.

Should corrosion form on the brake rotors, the brakes will tend to respond with a pulsating effect that even extended application will fail to cure.

## Cargo loading

 To avoid loading the tires beyond their approved carrying capacity, never overload the vehicle. Overloading can lead to overheating and increases the rate at which damage develops inside the tires. The ultimate result can assume the form of a sudden air loss. ◀

### Determining the load limit



1. Locate the following statement on the driver's door pillar:

 The combined weight of occupants and cargo should never exceed XXX lbs or YYY kg. Failure to observe this can compromise your vehicle's driving stability and cause vehicle damage. ◀

2. Determine the combined weight of the driver and passengers that will be riding in your vehicle
3. Subtract the combined weight of the driver and passengers from XXX pounds or YYY kilograms

4. The resulting figure equals the available amount of cargo and luggage load capacity.

For example, if the XXX amount equals 1,400 lbs and there will be five 150-lbs passengers in your vehicle, the amount of available cargo and luggage load capacity is 650 lbs:

$$1,400 \text{ lbs} \text{ minus } 750 \text{ lbs} = 650 \text{ lbs}$$

5. Determine the combined weight of luggage and cargo being loaded on the vehicle. That weight should never exceed the available cargo and luggage load capacity calculated in Step 4
6. If your vehicle will be towing a trailer, part of the load from your trailer will be transferred to your vehicle. Consult the manual for transporting a trailer to determine how this may reduce the available cargo and luggage load capacity of your vehicle.

### Load

The permitted load is the total of the weight of occupants and cargo/luggage. The greater the weight of occupants, the less cargo/luggage can be transported.

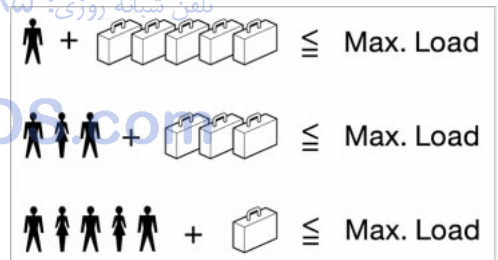



## Stowing cargo

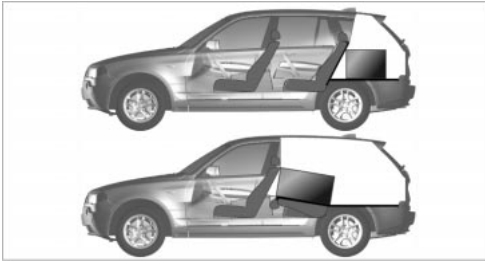

BMWDS2014M

- ▷ Load heavy cargo as far forward and as low as possible, placing it directly behind the bulkhead behind the rear seats
- ▷ Cover sharp edges and corners
- ▷ Pull out the partition net, refer to page 72, making sure that objects cannot penetrate the partition net

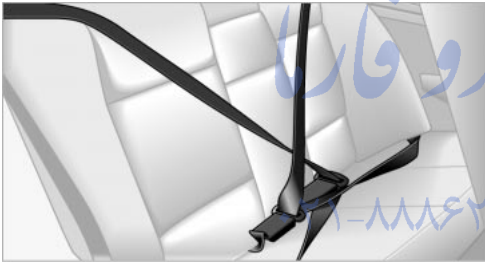

BMWDS2014M

- ▷ For very heavy cargo when the rear seat is not occupied, secure each safety belt in the opposite buckle.

## Cargo, securing

- ▷ Use the luggage net\* to hold down small and lightweight luggage and cargo, refer to page 72
- ▷ For larger and heavier pieces, load securing equipment\* is available from your BMW Sports Activity Vehicle Center. Lashing eyes for attaching these heavy-duty straps have been provided in your vehicle's luggage compartment, refer to page 73
- ▷ Read and comply with the information enclosed with the load-securing devices.

 Always position and secure the load correctly. If you do not, it can even endanger the passengers during braking or evasive maneuvers.

Never exceed either the approved gross vehicle weight or either of the approved axle loads, refer to page 116, as excessive loads can pose a safety hazard, and may also place you in violation of freeway safety laws.

You should never transport heavy or hard objects unsecured in the passenger compartment, as they could fly around and pose a safety hazard to the vehicle's occupants even during abrupt braking or evasive maneuvers. ◀

## Roof-mounted luggage rack\*

Because roof racks raise the vehicle's center of gravity when loaded, they have a major effect on its handling and steering response.

You should therefore always remember not to exceed the approved roof weight, the approved gross vehicle weight or the axle loads when loading the rack.

You can find the specified weights in the Technical data section on page 116.

Make sure that the load is not too heavy, and that it does not extend outward to beyond the limits of the loading surface. Always load the heaviest pieces first – on the bottom. Be sure that adequate clearance is maintained for raising the glass roof, and that objects do not project into the opening path of the tailgate.

Secure roof-mounted cargo correctly and securely to prevent it from shifting or being lost during the trip.

Drive smoothly. Avoid sudden acceleration and braking maneuvers. Take corners gently.

## Driving on bad roads

Your BMW X3 is at home on all paved and unpaved roads. It combines all-wheel drive with the advantages of a normal passenger car.

 Driving on unpaved terrain can cause damage to the vehicle. ◀

When you are driving on bad roads, there are a few points which you should strictly observe – for your own safety, for that of your passengers, and for the safety of the vehicle:

- ▷ Familiarize yourself with the vehicle before you begin driving. Do not take risks with the vehicle under any circumstances
- ▷ Always adapt the driving speed to the road conditions. The more steep and uneven the roadway is, the lower the speed should be
- ▷ You can operate your vehicle on uphill and downhill gradients with a maximum slope of 50%. If you wish to drive on uphill and downhill grades of this nature, make sure beforehand that the engine oil and coolant levels are near the max mark, refer to pages 94 and 96
- ▷ For very steep downhill driving, use Hill Descent Control HDC, refer to page 51. Driving off is possible on upward inclines of up to 33%. The permitted side inclination is 50%
- ▷ While driving, watch carefully for obstacles such as rocks or holes. Try to avoid these obstacles whenever possible
- ▷ Avoid that the body makes contact with the ground, e.g. on the crests of hills and bumpy roads
- ▷ Do not drive in water that is deeper than 20 in/50 cm. If you must drive through water up to that depth, drive at a walking speed and do not stop. After leaving the water, press on the footbrake gently several times while driving at a low speed. The brake applications will help to dry the brakes, thus preventing a reduction in braking performance caused by the moisture.

For cleaning the handbrake, apply the lever slightly at approx. 25 mph/40 km/h and continue to drive for approx. 200 yards/200 meters, provided that traffic conditions allow you to do so.

Please bear the following points in mind after driving on poor roads, in order to preserve the road safety of your BMW:

- ▷ Clean the heavy dirt from the body
- ▷ Clean mud, snow, ice and other materials from the wheels and tires. Check the tires for damage.

# امداد خودرو فارما

تلفن شبانه روزی: ۰۲۱-۸۸۸۶۲۰۸۵

[FarmaSOS.com](http://FarmaSOS.com)



# امداد خودرو فارما

تلفن شبانه روزی: ۰۲۱-۸۸۸۶۲۰۸۵

[FarmaSOS.com](http://FarmaSOS.com)

## Mobility

This section helps you maintain your mobility by supplying important information on vital topics including fuels and lubricants, wheels and tires, service, maintenance and how to deal with any problems that may occur.

امداد خودرو فارما

تلفن شبانه روزی: ۰۲۱-۸۸۸۶۲۰۸۵

[FarmaSOS.com](http://FarmaSOS.com)

# Refueling

## Fuel filler door

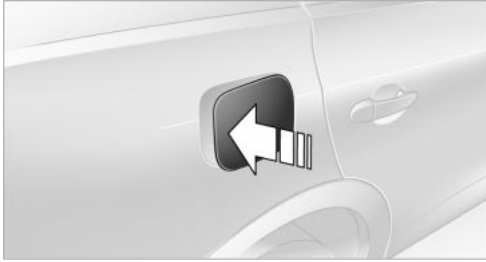

To open and close: press the rear edge of the fuel filler door.

## Manual release



In the event of an electrical defect in the system, you can release the fuel filler door manually:

1. Open the cover flap in the luggage compartment on the right-hand side panel, refer to page 72
2. Pull the green button.

 When handling fuels always observe any safety guidelines posted at the service station. ◀

## Simple and environmentally friendly



Put the filler cap in the bracket attached to the fuel filler door.

 When handling fuels, comply with all of the applicable safety precautions posted at the service station. ◀

When refueling, insert the filler nozzle completely into the filler pipe. Lifting the filler nozzle during refueling

- ▷ results in premature pump shutoff
- ▷ can lead to reduced efficiency in the fuel-vapor recovery system.

The fuel tank is full when the filler nozzle clicks off the first time.

## To close the fuel filler cap

Fit the cap and turn it clockwise until you clearly hear a click – bayonet fitting.

 Close the filler cap carefully after refueling, until a click is heard. While closing, be sure not to squeeze the strap which is fastened to the cap. A loose or missing cap will activate the Check Gas Cap lamp. ◀

 Check Gas Cap  
This indicator lamp comes on when the fuel filler cap is loose or missing. Close the fuel filler cap tightly as described above.

## Fuel tank capacity

- ▷ approx. 17.7 gallons/67 liters, of which
- ▷ approx. 2 gallons/8 liters are reserve.

 Never attempt to continue driving until the tank is completely empty, as engine functions could be affected, and the vehicle could sustain damage as a result. ◀

## Fuel specifications

The engine uses lead-free gasoline only.

Required fuel:

Premium Unleaded Gasoline,  
minimum 91 AKI

AKI = Anti Knock Index.

 Do not use leaded fuels. The use of leaded fuels will cause permanent damage to the system's oxygen sensor and the catalytic converter. ◀

امداد خودرو فارما

تلفن شبانه روزی: ۰۲۱-۸۸۸۶۲۰۸۵

FarmaSOS.com

# Wheels and tires

## Tire inflation pressure

### Information for your safety

It is not merely the tire's service life, but also driving comfort and – to a great extent – driving safety that depend on the condition of the tires and the maintenance of the specified tire pressure.

 Check the tire inflation pressure regularly and correct it if necessary, including compact wheel: at least every two weeks and before beginning a longer trip. If you fail to observe this precaution you may be driving on tires with incorrect tire pressures, a condition that cannot only compromise your vehicle's driving stability, but also lead to tire damage and the risk of an accident.

Do not drive with a depressurized, i.e. flat tire. A flat tire will seriously impair your vehicle's handling and braking response. Attempts to drive on a flat tire can lead to loss of control over the vehicle. ◀

### Checking the pressure

Only check tire inflation pressure when the tires are cold. That means after a maximum of 1.25 miles/2 km driving or when the vehicle has been parked for at least 2 hours. When tires are warm, the tire inflation pressure increases.

After correcting the inflation pressure(s), always reinitialize the Flat Tire Monitor, refer to page 53.

## Checking inflation pressure



MV02557CMA

The inflation pressures for your standard tires can be seen on the door pillar when you open the driver's door.

 After correcting the inflation pressure(s), always reinitialize the Flat Tire Monitor, refer to page 53. ◀

### Inflation pressure for other tire sizes

The table below provides all the correct inflation pressures for the specified tire sizes at ambient temperature.

 For correct identification of the right tire inflation pressure for your tires, observe the specifications for the corresponding tire size. ◀

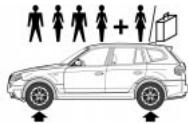

### X3 2.5i/3.0i

Tire size	Pressure specifications in psi/kPa			
	max. 			
215/60 R 17 96 H M+S	32/220	35/240	35/240	41/280
215/60 R 17 96 Q, T, H M+S				
235/50 R 18 97 H M+S				
235/50 R 18 97 V				
235/55 R 17 99 H M+S	29/200	32/220	32/220	38/260
235/55 R 17 99 Q, T, H M+S				
Front: 235/50 R 18 97 V	32/220	-	35/240	-
Rear: 255/45 R 18 99 V	-	32/220	-	38/260
Front: 235/45 R 19 95W	32/220	-	35/240	-
Rear: 255/40 R 19 96W	-	35/240	-	41/280
Compact wheel T 135/90 R 17 104 M			61/420	

More details on the permitted load and weights can be found on page 116.

تلفن شبانه روزی: ۰۲۱-۸۸۸۶۲۰۸۵

FarmaSOS.com

## Tire identification marks

Knowledge of the labeling on the side of the tire makes it easier to identify and choose the right tires.

### Tire size

e.g. 205/60 R 15 91 W

Nominal width in mm \_\_\_\_\_

Aspect ratio in % \_\_\_\_\_

Radial type \_\_\_\_\_

Rim diameter in inches \_\_\_\_\_

Load rating (not on ZR tires) \_\_\_\_\_

Speed rating (before R on ZR tires) \_\_\_\_\_

### Speed code letter

T = up to 118 mph/190 km/h

H = up to 131 mph/210 km/h

V = up to 150 mph/240 km/h

W = up to 167 mph/270 km/h

Y = up to 186 mph/300 km/h

### Tire Identification Number

Tires with DOT codes meet the guidelines of the U.S. Department of Transport.

DOT code:

e.g. DOT xxxx xxx 3603

Manufacturer code for tire make \_\_\_\_\_

Tire size and tire design \_\_\_\_\_

Tire age \_\_\_\_\_

### Tire age

The tire's date of manufacture is indicated on the sidewall:

DOT ... 3603 indicates that a tire was manufactured in week 36 of the year 2003.

BMW recommends that you replace all tires after 6 years at the latest, independently of the fact that tires can reach an age of 10 years.

## Uniform Tire Quality Grading

Quality grades can be found where applicable on the tire sidewall between tread shoulder and maximum section width.

For example:

Tread wear 200 Traction AA

Temperature A

### DOT Quality Grades

Treadwear

Traction AA A B C

Temperature A B C



All passenger car tires must conform to Federal Safety Requirements in addition to these grades. ◀

### Treadwear

The treadwear grade is a comparative rating based on the wear rate of the tire when tested under controlled conditions on a specified government test course.

For example, a tire graded 150 would wear one and one-half (1 ½) times as well on the government course as a tire graded 100.

The relative performance of tires depends upon the actual conditions of their use, however, and may depart significantly from the norm due to variations in driving habits, service practices and differences in road characteristics and climate.

### Traction

The traction grades, from highest to lowest, are AA, A, B, and C.

Those grades represent the tire's ability to stop on wet pavement as measured under controlled conditions on specified government test surfaces of asphalt and concrete. A tire marked C may have poor traction performance.



The traction grade assigned to this tire is based on straight-ahead braking traction tests, and does not include acceleration, cornering, hydroplaning, or peak traction characteristics. ◀

### Temperature

The temperature grades are A – the highest – B, and C, representing the tire's

resistance to the generation of heat and its ability to dissipate heat when tested under controlled conditions on a specified indoor laboratory test wheel.

Sustained high temperature can cause the material of the tire to degenerate and reduce tire life, and excessive temperature can lead to sudden tire failure. The grade C corresponds to a level of performance which all passenger car tires must meet under the Federal Motor Vehicle Safety Standard No. 109. Grades B and A represent higher levels of performance on the laboratory test wheel than the minimum required by law.

 The temperature grade for this tire is established for a tire that is properly inflated and not overloaded. Excessive speed, underinflation, or excessive loading, either separately or in combination, can cause heat buildup and possible tire failure. ◀

### M+S

Winter and all-season tires. These have better winter properties than summer tires.

## Tire condition

Inspect your tires frequently for treadwear, signs of damage and for foreign objects lodged in the tread. Check the tread pattern depth.

### Tire tread

The tread depth should not drop below 0.12 in/3 mm, although, for example, European legislation only specifies a minimum tread depth of 0.063 in/1.6 mm. At tread depths below 0.12 in/3 mm, there is an increased risk of high-speed hydroplaning, even when only small amounts of water are present on the road surface.

As winter tires display a noticeable loss in their ability to cope with cold-weather driving conditions once the tread wears to below 0.16 in/4 mm, to ensure continued

safety you should always have such tires replaced.

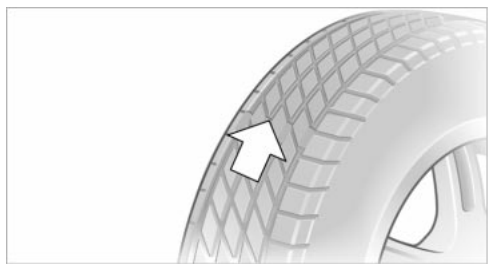

Wear indicators at the tread-groove base, refer to arrow, are distributed over the tire's circumference and are marked on the tire sidewall with TWI – Tread Wear Indicator. At a tread depth of 0.063 in/1.6 mm these indicators, signal that the tires have reached the legally permissible wear limit.

### Tire damage

 Unusual vibrations encountered during normal vehicle operation can indicate tire failure or some other vehicle defect. This can, for example, be caused by driving over curbs. These kinds of problems may also be signaled by other changes in vehicle response, such as a strong tendency to pull to the left or right. Should this occur, respond by immediately reducing your speed. Proceed carefully to the nearest BMW Sports Activity Vehicle Center or professional tire center, or have the vehicle towed in to have it, its wheels and tires inspected.

Tire damage, extending to sudden and complete loss of pressure in extreme cases, can pose a potentially lethal safety hazard for the vehicle's occupants and other road users alike. ◀

## Replacing wheels/tires

 Unprofessional attempts by laymen to service tires can lead to damage and accidents.

Have this work performed by skilled professionals only. All BMW Sports Activity Vehicle Centers will be happy to help you

with specialized knowledge and corresponding equipment. ◀

The correct wheel and tire combination affects various systems whose function would otherwise be impaired, e.g. ABS, DSC or xDrive.

Have the wheel and tire assemblies balanced every time either a wheel or a tire is replaced.



BMW does not recommend the use of retreaded tires, as otherwise driving safety may be reduced. Possible variations in the design and the age – which could be substantial – of the carcasses can lead to unusually rapid wear. ◀

### The right wheels and tires



BMW recommends that you use only wheel and tire combinations that BMW has tested and approved for your particular vehicle. Variations in factors such as manufacturing tolerances mean that even wheels and tires with identical official size ratings could actually have different dimensions than the approved units – these differences could lead to body contact, and with it the risk of severe accidents. If non-approved wheels and tires are used, BMW cannot evaluate their suitability, and therefore cannot be held liable for driving safety. ◀

To maintain good handling and vehicle response, use only tires of a single tread configuration from a single manufacturer. After a flat tire, always remember to have the specified wheel and tire combination remounted on the vehicle as soon as possible.

### Recommended tire brands

BMW tests certain tire brands for each tire size, classifies them as road-safe and approves them. You can obtain a list of these from your BMW Sports Activity Vehicle Center. Observe any country-specific regulations, e.g. on making a corresponding entry in the vehicle documents.

The factory-mounted tires have been specially selected to provide optimized perfor-

mance when installed on your vehicle; if properly cared for, they will provide a combination of safety and excellent ride comfort.

### Special characteristics of winter tires

BMW recommends winter tires for use in cold winter driving conditions. Although all-season M+S tires provide better winter traction than summer tires, they generally fail to provide the same levels of cold-weather performance as winter tires.

When switching to winter tires, observe the descriptions at Tire condition and Replacing wheels/tires, refer to page 89.

### Observing speed ratings



Never exceed the maximum speed for which the winter tires are rated.

Unprofessional attempts by laymen to service tires can lead to damage and accidents. Have this work performed by skilled professionals only. The technicians at your BMW Sports Activity Vehicle Center will be glad to assist you with the required professional knowledge and specialized equipment. ◀ تلفن شبانه روزی

### Storage

Store wheels or tires in a cool, dry place, protecting them against light whenever possible. Protect the tires against contact with oil, grease and fuel.

Do not exceed the maximum tire inflation pressure specified on the side of the tire.

### Snow chains\*



Do not exceed a vehicle speed of 30 mph/50 km/h with snow chains mounted. ◀

Only certain snow chains have been tested by BMW and classified and approved as safe. You can obtain a list of these from your BMW Sports Activity Vehicle Center. BMW recommends the use of approved narrow-link snow chains only. These snow chains are approved exclusively for use on

summer or winter tires in pairs on the rear wheels.

Observe the manufacturer's instructions when installing snow chains.



After mounting snow chains, do not initialize the Flat Tire Monitor.

When you are driving with snow chains, it can be beneficial to switch off DSC briefly, refer to page 51. ◀

امداد خودرو فارما

تلفن شبانه روزی: ۰۲۱-۸۸۸۶۲۰۸۵

FarmaSOS.com

# Under the engine hood

**⚠** Never attempt to perform any service or repair operations on your vehicle without the required professional technical training. If you are unaware of the regulations that need to be observed, BMW recommends that you have this work performed at a BMW Sports Activity Vehicle Center, as otherwise unqualified handling of parts and materials can lead to safety risk for vehicle occupants and other road users. ◀

## Hood

### Unlocking



Pull the lever located under the left side of the instrument cluster.

### Opening

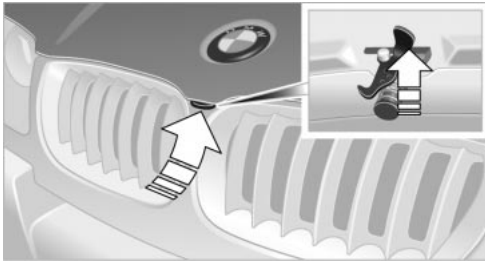

Press the release handle and open the engine hood.

### Closing



Let the engine hood fall from approx. 1 ft/ 30 cm so that it can be heard to engage.

**⚠** Observe the same precautions that apply to all closing operations by ensuring that the hood's travel range is clear and unobstructed before allowing the hood to fall into position.

If you see any signs that the hood is not completely closed while driving your vehicle, you should stop at once and close it securely. ◀

FarmaSOS.com

## Engine compartment

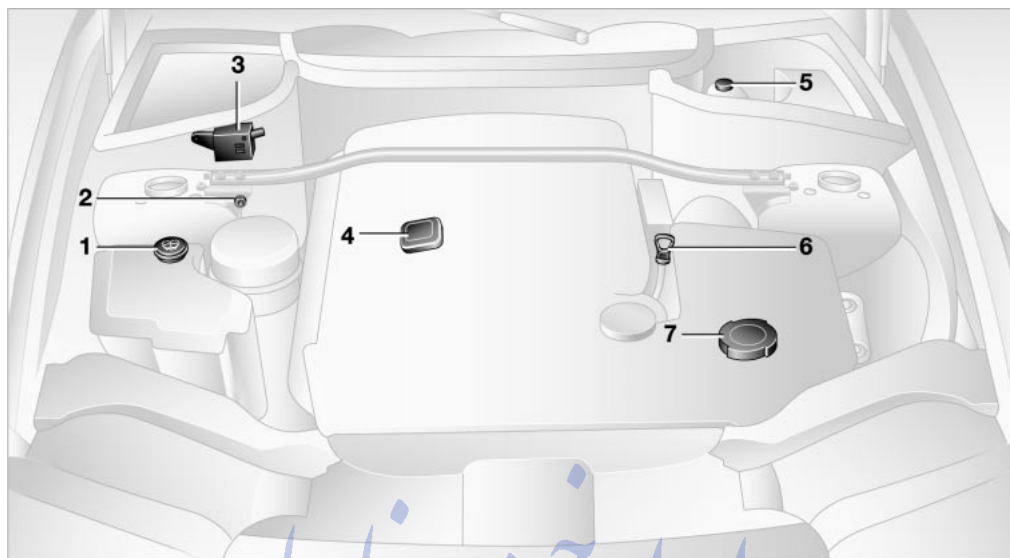



- |   |   |     |   |                         |    |
|---|---|-----|---|-------------------------|----|
| 1 | Reservoir for windshield and headlamp washer system | 94  | 5 | Brake fluid reservoir   | 96 |
| 2 | Body ground - negative terminal                     | 108 | 6 | Dipstick for engine oil | 94 |
| 3 | Auxiliary terminal for jump-starting                | 108 | 7 | Coolant expansion tank  | 96 |
| 4 | Engine oil filler neck                              | 95  |   |                         |    |
- تلفن شبانه روزی: ۰۸۵ ۸۸۶۲۰۱ - ۹۵

FarmaSOS.com

## Washer fluid

### Windshield and headlamp washer system

 Antifreeze agent for the washer systems is inflammable. For this reason, keep it away from sources of flame and store it only in its original containers. Store it so that it is inaccessible to children. Always observe the instructions for use provided on the containers. ◀

 We recommend that you mix the washer fluid before adding it to the reservoir. ◀

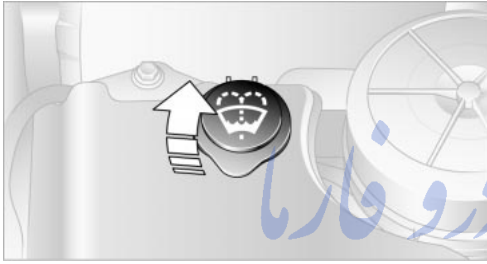

Capacity:  
approx. 6.9 US quarts/6.5 liters.

Fill with water and, if required, with an anti-freeze additive according to manufacturer's recommendations.

## Engine oil

### Indicator lamp

#### Engine oil pressure

 The indicator lamp lights up red: Stop the vehicle immediately and switch off the engine. Check the engine oil level; top up as required. If the oil level is correct: contact the nearest BMW Sports Activity Vehicle Center.

 Do not continue driving. The engine could be damaged because of inadequate lubrication. ◀

### Engine oil level



The indicator lamp lights up yellow while driving:  
The oil level is at the absolute minimum. Add engine oil as soon as possible. Until then, do not drive more than approx. 30 miles/50 km.



The indicator lamp lights up yellow after the engine is switched off:  
Top up engine oil at the earliest opportunity - when refueling.

### Engine oil sensor



The indicator lamp lights up yellow within 20 seconds after starting the engine:

The oil level sensor is defective. Please have it checked by a BMW Sports Activity Vehicle Center.

### Checking oil level



1. Park the vehicle on a level surface
2. Switch the engine off after it has reached normal operating temperature
3. After approx. 5 minutes, pull the dipstick out and wipe it off with a clean lint-free cloth, paper towel, or similar material
4. Carefully push the dipstick all the way into the guide tube and pull it out again
5. The oil should extend to between the two marks on the dipstick.

As is the case with fuel economy, the rate at which the engine uses oil is strongly influenced by driving style and operating conditions.

The oil quantity between the two marks of the dipstick is approx. 1.1 US quarts/1 liter.



Do not fill beyond the upper mark on the dipstick. Excess oil can damage the engine.

## Adding engine oil



While you should wait until the level has dropped to just above the lower mark before adding oil, you should never allow the oil level to fall below this mark.

 BMW engines are designed to operate without additives, and their use could even lead to damage in some cases. This also applies to the manual transmission, automatic transmission, the differential and the power steering system. ◀

Recommendation: have the oil change conducted by your BMW Sports Activity Vehicle Center.

 Continuous exposure to used oil has caused cancer in laboratory testing. For this reason, any skin areas that come into contact with oil should be thoroughly washed with soap and water. Always store oils, grease and similar materials so that they are inaccessible to children. Comply with warning labels and information on containers. ◀

 Always observe all applicable rules and regulations for environmental protection when disposing of used oil. ◀

## Approved engine oils

The quality of the engine oil selected has critical significance for the operation and service life of an engine. Based on extensive testing, BMW has approved only certain engine oils.

Use only approved BMW High Performance Synthetic Oil.

If you are unable to obtain BMW High Performance Synthetic Oil, you can add small amounts of another synthetic oil between oil changes. Use only oils with the API SH specification or higher.

 Ask your BMW Sports Activity Vehicle Center for details concerning the specific BMW High Performance Synthetic Oil or synthetic oils which have been approved. ◀

You can also call BMW of North America at 1-800-831-1117 or visit this website: [www.bmwusa.com](http://www.bmwusa.com) to obtain this information.

## Viscosity ratings

Viscosity is the oil flow rating as defined in SAE classes.

The selection of the correct SAE class depends on the climate conditions in the area where you typically drive your BMW.

 Approved oils are in SAE classes 5W-40 and 5W-30. ◀

▷ These oils may be used for driving in all ambient temperatures.

## Coolant

### Indicator lamp

 The indicator lamp lights up: Coolant level is too low; top up at the earliest opportunity.

 Do not add coolant to the cooling system when the engine is hot. Escaping coolant can cause burns.

Antifreeze and anticorrosion agents are hazardous to health. You should always store them in their original containers and in a location which is inaccessible to children. Antifreeze and anticorrosion agents are flammable. Therefore, do not pour over hot engine parts, as otherwise they could catch fire and cause burns. Always observe the instructions for use provided on the containers. ◀

## Checking coolant level and topping up coolant

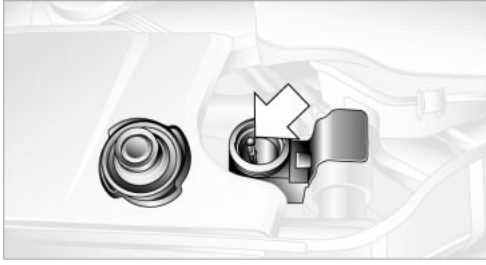

Check the coolant level with the engine cold, approx. 68 °F / 20 °C:

1. Turn the cap of the expansion tank counterclockwise to allow any accumulated pressure to escape, then continue turning to open
2. The coolant level is correct if the upper end of the red float bar is at least at the same height as the top edge of the filler neck, refer to arrow. The bar end may only protrude by a maximum of  $\frac{3}{4}$  in / 2 cm, i.e. up to the second mark on the float bar, refer also to sketch beside the filler neck
3. If necessary, add coolant. Slowly add coolant until the correct level is reached – do not overfill.



Always observe all applicable rules and regulations for environmental protection when disposing of used anti-freeze and anticorrosion agents. ◀



During continued driving increased brake pedal pressure may be necessary, and considerably longer braking distances may result. Please adapt your driving style accordingly. ◀



Warning lamp for Canadian models.

## Brake pads



The indicator lamp comes on. The brake pads have reached their minimum pad thickness. See your BMW Sports Activity Vehicle Center immediately to have the pads replaced.



For your own safety: use only brake pads that BMW has released for your particular vehicle model. As BMW cannot assess the suitability of other brake pads for use on your vehicle, we are unable to assume continued responsibility for the vehicle's operating safety if non-approved pads are installed. ◀

For additional information on the brake system, refer to page 77.

## Brake system

### Malfunction

#### Brake fluid



The warning lamp lights up red despite the handbrake being released: stop immediately.

The brake fluid in the reservoir has fallen to below the minimum level. At the same time, a considerably longer brake pedal travel may be noticeable. Contact the nearest BMW Sports Activity Vehicle Center.

# Maintenance

## The BMW maintenance system



The BMW maintenance system is designed in such a way that it reliably ensures the road safety and operating reliability of the vehicle – keeping the cost for you as low as possible.

Regular maintenance is not only required for the safety of the vehicle, it also improves the resale value.

### Service Interval Display

The BMW Maintenance System takes the driving conditions of the vehicle into account when determining service intervals:

From the point of view of maintenance, 62,000 miles/100,000 km accumulated in short-distance urban driving are not the equivalent of the same distance covered at moderate speeds in long-distance highway travel.

The BMW maintenance system is divided into engine oil service as well as Inspections I and II.

Determining the maintenance intervals according to the actual loads on the vehicle covers every kind of operating situation. However, even those who drive only short distances – significantly less than 6,200 miles/10,000 km annually – should have the engine oil changed at least every 2 years since oil deteriorates over time, regardless of use.

**⚠** Brake fluid is hygroscopic: it absorbs moisture from the atmosphere over the course of time. To ensure that the brake system continues to provide safe and reliable performance, remember to have the brake fluid changed every two years at the latest by a BMW Sports Activity Vehicle Center, also refer to page 46 and to the Service and Warranty Information Booklet for US models or the Warranty and Service Guide Booklet for Canadian models. ◀

### Service and Warranty Information Booklet for US models/Warranty and Service Guide Booklet for Canadian models

For detailed information on required maintenance items and the work involved, please refer to the Service and Warranty Information Booklet for US models or to the Warranty and Service Guide Booklet for Canadian models.

Depending on operating conditions, it may be advisable to have the body checked for damage from rocks or gravel as a precaution against corrosion.

**▶** BMW recommends that you have your BMW Sports Activity Vehicle Center perform the maintenance and repair.

Check that the maintenance work is recorded in the Service and Warranty Information Booklet for US models or the Warranty and Service Guide Booklet for Canadian models. These entries will serve as proof that the vehicle has received regular maintenance. ◀

### Care

For all information on this subject, refer to the Caring for your vehicle brochure.

# Laws and regulations

## California Proposition 65 Warning

California laws require us to state the following warning:

 Engine exhaust and a wide variety of automobile components and parts, including components found in the interior furnishings in a vehicle, contain or emit chemicals known to the State of California to cause cancer and birth defects and reproductive harm. In addition, certain fluids contained in vehicles and certain products of component wear contain or emit chemicals known to the State of California to cause cancer and birth defects or other reproductive harm. Battery posts, terminals and related accessories contain lead and lead compounds. Wash your hands after handling. Used engine oil contains chemicals that have caused cancer in laboratory animals. Always protect your skin by washing thoroughly with soap and water. ◀



If the Service Engine Soon indicator lamp comes on either continuously or intermittently, this indicates a fault in the emissions-related electronic systems. Although the vehicle remains operational, you should have the systems checked by your BMW Sports Activity Vehicle Center at the earliest possible opportunity.

The illuminated indicator lamp informs you of the need for service, not that you need to stop the vehicle. However, the systems should be checked by your BMW Sports Activity Vehicle Center at the next opportunity.

If the indicator lamp blinks or flashes, this indicates a high level of engine misfire. Reduce speed and contact the nearest BMW Sports Activity Vehicle Center immediately. Severe engine misfiring over even a short period of time can seriously damage emission control system components, especially the catalytic converter.

## OBD connector

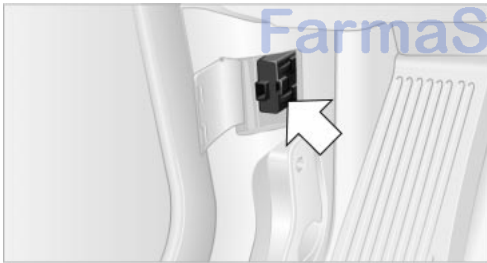

The interface socket for the Onboard Diagnostic is located on the left of the driver's side at the bottom of the instrument cluster and under a cover. The cover has the letters OBD on it.

The most important components for the composition of the emissions can be checked by a device across this interface.



Service Engine Soon indicator lamp for Canadian models.



If the fuel filler cap is not on tight enough, the OBD system can detect leaking vapor and the indicator lamp will light up. If the fuel filler cap is then tightened, the indicator lamp will usually go out after a short period of time. ◀

# Replacing components

## Onboard tool kit

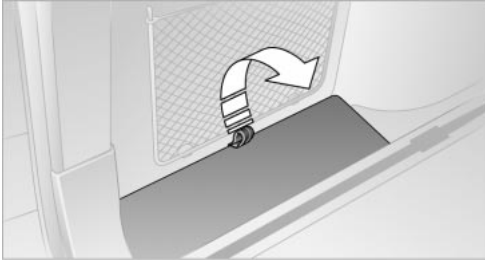

The onboard tool kit is located in a compartment on the left under the cargo area.

## Rear



1. Lift the wiper arm
2. Pull off the wiper blade, refer to arrow
3. Insert a new wiper blade.

## Replacing wiper blades

### Front

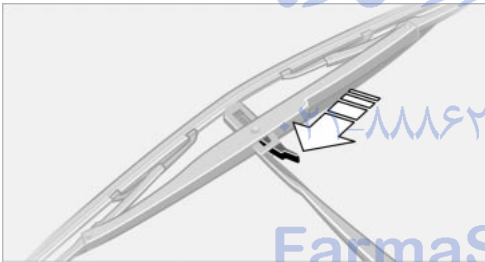

1. Move the wiper to a fold-out position, refer to page 42
2. Lift the wiper arm and press the securing spring, refer to arrow
3. Pull the wiper blade off toward the wiper arm
4. Insert the new blade and snap it into place.

 Fold the wipers back down onto the windshield before you turn the ignition key to position 1 or 2 again. If you do not, they could be damaged. ◀

## Lamps and bulbs

The lamps and bulbs make essential contributions to the safety of your vehicle. Therefore, comply fully with the following instructions during bulb replacement. If you are not familiar with the specified procedures, BMW recommends having the replacements carried out at your BMW Sports Activity Vehicle Center.

 Never touch the glass of new bulbs with your bare fingers, as even minute amounts of contamination will burn into the bulb's surface and reduce its service life. To install, use a clean cloth, napkin etc. or hold the bulb by its metal socket. ◀

A replacement bulb set is available from your BMW Sports Activity Vehicle Center.

 To prevent short circuits, before working on any electrical system, equipment or accessory you should always switch it off and disconnect the cable from the battery's negative terminal before starting.

To avoid possible injury or equipment damage when changing bulbs, observe any instructions provided by the bulb manufacturer. ◀

 When maintaining the headlamps, please comply with the instructions in the separate Caring for your vehicle brochure. ◀

## Halogen low beams

H7 bulb, 55 Watts

 Always wear gloves and eye protection – the atmosphere within the bulb is pressurized. Failure to observe this precaution can lead to personal injury should the bulb be damaged. ◀

### Driver's side



1. Apply the screwdriver from the on-board tool kit and pull off the lamp cover

 Caution when handling the screwdriver, as otherwise personal injury can occur or the vehicle can be damaged. ◀

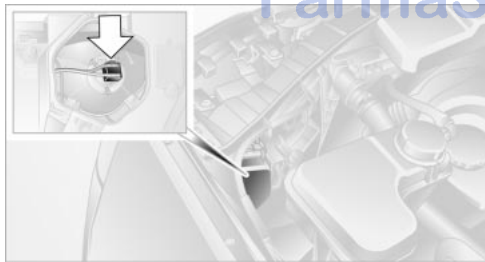

2. Press the bulb holder downward and remove
3. Remove the bulb, mount a new bulb
4. Apply the bulb holder with the lower edge to the bracket and press it in until the lamp base locks in place.

## Front passenger side



Before replacing the bulb, remove the reservoir for the windshield washing system from the bracket. To do so, loosen the bolt, refer to arrow, and place the reservoir to one side.

 Bear in mind that the windshield washing system reservoir is heavy. If you do not, injuries or damage to the vehicle can occur. ◀

For bulb replacement procedure, refer to Driver's side.

## Halogen high beams

H7 bulb, 55 Watts

 Always wear gloves and eye protection – the atmosphere within the bulb is pressurized. Failure to observe this precaution can lead to personal injury should the bulb be damaged. ◀

### Driver's side

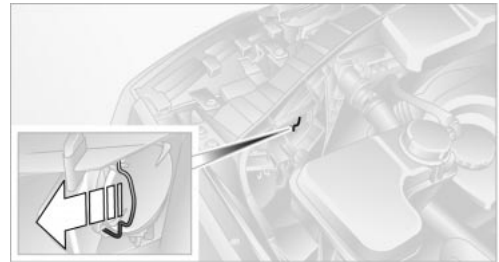

1. Open the clip and remove the lamp cover
2. Press the bulb holder downward and remove, refer to Low beams
3. Pull off the lamp base; fit a new lamp base



- Apply the lamp base with the lower edge to the bracket and press it in until the lamp base locks in place.

**⚠** Make sure that the cover does not fall into the engine compartment, as otherwise the vehicle can be damaged or other road users can be endangered. ◀

### Front passenger side



Before replacing the bulb, remove the reservoir for the windshield washing system from the bracket. To do so, loosen the bolt, refer to arrow, and place the reservoir to one side.

**⚠** Bear in mind that the windshield washing system reservoir is heavy. If you do not, injuries or damage to the vehicle can occur. ◀

For bulb replacement procedure, refer to Driver's side.

### Xenon lamps\*

The service life of these bulbs is very long and the probability of a failure is very low, provided that they are not switched on and off an unusual number of times. If one of these bulbs should nevertheless fail, it is possible to continue driving with great caution using the fog lamps, provided traffic laws in your area do not prohibit this.

**⚠** To avoid risk of potentially fatal injuries: owing to the extremely high voltages at which these units operate, service work should always be entrusted to qualified personnel. ◀

### Parking and standing lamps

5 Watt bulb

In case of a defect, please contact your BMW Sports Activity Vehicle Center.

### Turn signal indicator, front

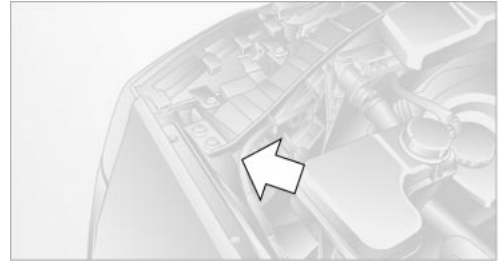

21 Watt bulb

Access to the turn signal indicator is at the edge of the lamp unit, refer to arrow.

**⚠** Make sure that the lamp base does not fall into the engine compartment, as otherwise the vehicle can be damaged or other road users can be endangered. ◀

- Turn the lamp base and remove it
- Replace the bulb
- Insert the lamp base. If it does not snap in place immediately, turn the lamp base until it does.

### Side-mounted turn signal indicators

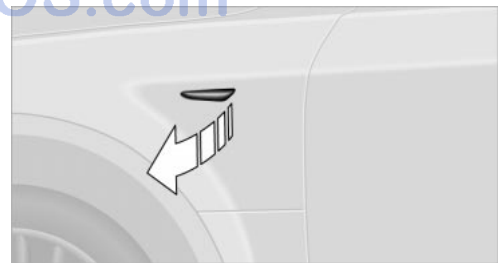

5 Watt bulb

- Use finger pressure against the rear end of the lamp, refer to arrow, to press it forward for removal
- Apply gentle pressure to the bulb while turning it to the left and pull it out
- Install in the opposite order.

## Front fog lamps

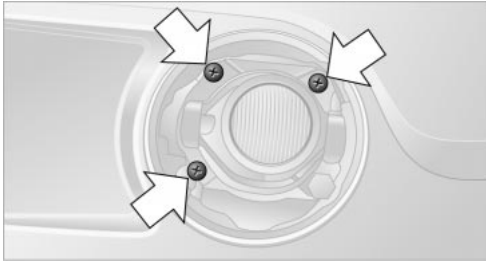

H11 bulb, 55 Watts

**⚠** Always wear gloves and eye protection – the atmosphere within the bulb is pressurized. Failure to observe this precaution can lead to personal injury should the bulb be damaged. ◀

1. Pull the cover in front of the fog lamp forward
2. Loosen the screws, refer to arrow, and pull out the headlamp
3. Turn the lamp base at the back of the headlamp to the left and remove it
4. Replace the bulb.

## Tail lamps

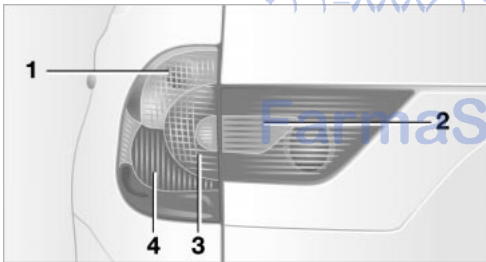

21 Watt bulb

- 1 Turn signal indicator
- 2 Backup lamps
- 3 Rear lamp
- 4 Rear lamp/brake lamp

## Replacing tail lamps



1. Open the flap in the side panel, refer to page 72
2. Lift the side panel if necessary
3. To release the plug-in connection of the cable, press the spring, refer to arrow 1
4. To remove the back panel of the lamp, release the retainer, refer to arrow 2
5. Apply gentle pressure to the bulb fitting while turning it to the left for removal and replacement
6. Install in the opposite order.

Lamps in the tailgate are defective: Please contact your BMW Sports Activity Vehicle Center.

## License plate lamp

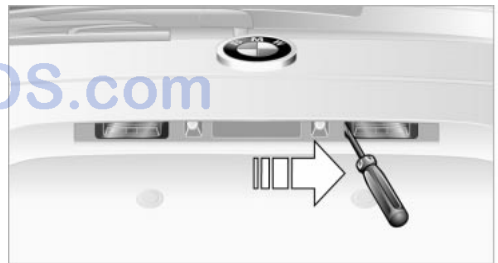

10 Watt bulb

1. Press the lamp out to the side with a screwdriver
2. Remove the lamp and replace the bulb.



## Tailgate lamp

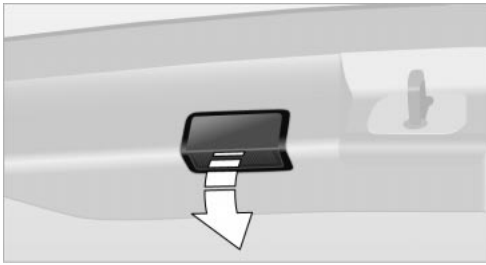

5 Watt bulb

1. Pull off the bulb holder
2. Replace the bulb.

## Light-emitting diodes LEDs

Light-emitting diodes installed behind translucent lenses serve as the light source for many of the controls and displays in your vehicle. These light-emitting diodes, which operate using a concept similar to that applied in conventional lasers, are officially designated as Class 1 light-emitting diodes.

 Do not remove the covers, and never stare into the unfiltered light for several hours, as irritation of the retina could result. ◀

## Changing a wheel

 Safety precautions to observe in the event of a flat tire and during all tire changes:

Park the vehicle as far as possible from passing traffic. Park on a firm, flat, surface. Switch on the hazard warning flashers. Lock the steering wheel in straight-ahead setting of the wheels. Set the handbrake and engage first gear, reverse gear or selector-lever position P.

All passengers should be outside the vehicle and well away from your immediate working area, behind a guardrail, for instance.

If a warning triangle or portable hazard warning lamp is required, set it up on the roadside at an appropriate distance from the rear of the vehicle. Comply with all

safety guidelines and regulations.

Change the wheel only on a level, firm surface which is not slippery. The vehicle or the jack could slip to the side if you attempt to raise the vehicle on a soft or slippery surface such as snow, ice, tiles, etc.

Position the jack on a firm support surface. Do not use a wooden block or similar object as a support base for the jack, as this would prevent it from extending to its full support height and reduce its load-carrying capacity.

To avoid serious or fatal injury: never lie under the vehicle, and never start the engine while it is supported by the jack. ◀

## What you will need

Open tailgate and raise or remove floor cover, refer to page 72.

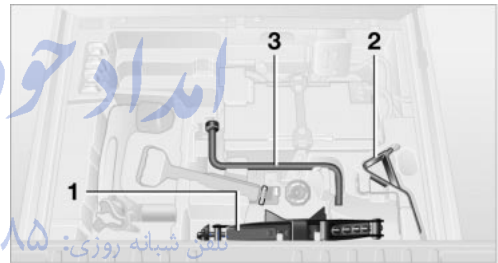

- 1 Vehicle jack
- 2 Chock
- 3 Lug wrench

In order to avoid rattling noises later, note the position of the tools when you remove them and return them to their original position when you are through using them.

## Compact wheel

The compact wheel is located under the cargo area on the floor of the vehicle.

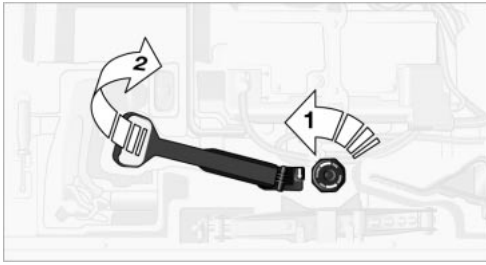

1. Unscrew bolt, refer to arrow 1
2. Fold up lifting handle, refer to arrow 2



3. Turn the handle to the left as far as possible, refer to arrow 3

 Turning the handle releases the compact wheel. Weight approx. 18 lbs/8 kg. It must be held with the handle. ◀

4. Slowly lower the handle as far as possible, refer to arrow 4

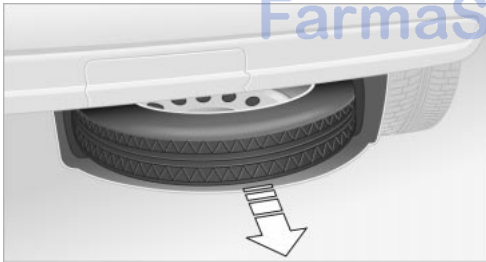

5. Take out the compact wheel towards the back
6. Refit the compact wheel holder in reverse order.

 The defective wheel cannot be fitted in the compact wheel holder in place of the compact wheel. ◀

## Preparing wheel change

 Observe the safety precautions on page 103. ◀

1. Secure the vehicle to prevent it from rolling:  
Place the wheel chock against the rear surface of the front tire on the side opposite the side being raised. If the vehicle is parked on a downward slope, place the wheel chock securely in front of the tire. If the wheel must be changed on a surface with a more severe slope, take additional precautions to secure the vehicle from rolling
2. Loosen the lug bolts by a ½ turn.

## Jacking up vehicle



1. Position the vehicle jack at the jacking point closest to the wheel so that the entire surface of the jack base perpendicularly contacts the ground under the jacking point



2. Guide the jack head into the rectangular recess of the jacking point when cranking up, refer to section of illustration
3. Jack the vehicle up until the wheel you are changing is raised from the ground.

## Mounting compact wheel

1. Unscrew the lug bolts and remove the wheel
2. Remove accumulations of mud or dirt from the mounting surfaces of the wheel and hub. Clean the lug bolts
3. Position the new wheel or compact wheel. Secure the wheel by turning at least two lug bolts into opposite bolt holes
4. Screw in the remaining lug bolts. Tighten all the bolts securely in a diagonal pattern
5. Lower the jack and remove it from beneath the vehicle
6. Tighten the lug bolts in a diagonal pattern
7. Check and correct the tire inflation pressure at the earliest opportunity.

 Protect valve stems and valve stem seal caps against dirt and contamination. Dirt in valve stems is a frequent source of gradual air loss. ◀

After mounting the compact wheel or correcting the inflation pressure, reinitialize the Flat Tire Monitor, refer to page 53.

 The vehicle jack is designed for changing wheels only. Do not attempt to raise another vehicle model with it or to raise any load of any kind. To do so could cause accidents and personal injury.

To ensure safety, always have the lug bolts checked with a calibrated torque wrench to ensure that they are tightened to the specified torque of 101 lb ft/140 Nm as soon as possible. ◀

Stow the defective wheel in the luggage compartment.

When you mount wheels other than Genuine BMW light-alloy wheels, different lug bolts may also be required.

Replace the defective tire as soon as possible and have the new wheel/tire balanced.

## Driving with the compact wheel

 Drive reservedly and do not exceed a speed of 50 mph/80 km/h. Do not deactivate DSC, as otherwise unstable driving conditions may result. ◀

The driving characteristics change, for example reduced track stability on braking, extended braking distance, and altered self-steering characteristics in the limit range. In conjunction with winter tires, these characteristics are more pronounced.

 Only one compact wheel may be mounted. You should re-equipping to wheels and tires of the original size as quickly as possible. ◀

## Battery

### Battery care

The battery is 100% maintenance-free, i.e., the electrolyte will last for the life of the battery when the vehicle is operated in a temperate climate.

 Please contact your BMW Sports Activity Vehicle Center with any questions concerning the battery. ◀

 Do not disconnect the battery when the engine is running. If you do so, the ensuing voltage surge will damage the vehicle's onboard electronics. ◀

### Indicator lamp

 The battery charge-current indicator lamp lights up:

The battery is no longer being charged. There is a defect on the alternator V-belt or charge current circuit of the alternator. Contact the nearest BMW Sports Activity Vehicle Center.

 Do not continue driving if the V-belt is defective. The engine could be damaged due to overheating.

Moreover, an increased amount of force is required for steering if the onboard supply voltage falls dramatically. ◀

## Charging the battery

Charge the battery in the vehicle only when the engine is not running. Use the connections provided in the engine compartment. For correct connections, refer to Jump-starting on page 108.

## Disposal



Bring old batteries to a collection point or your BMW Sports Activity Vehicle Center. Maintain the battery in an upright position for transport and storage. Always restrain the battery to prevent it from tipping over during transport. ◀

## Fuses



Never attempt to repair a blown fuse, and do not replace a defective fuse with a substitute of another color or amperage rating, as this could lead to a circuit overload, ultimately resulting in a fire in the vehicle. ◀

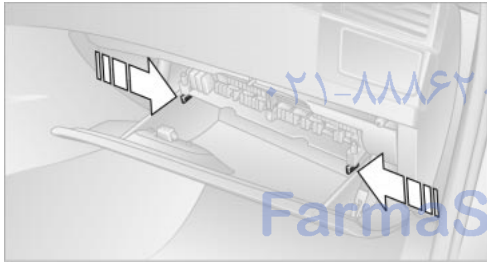

Open the glove compartment and turn the two quick-release fasteners to the left, refer to arrows.

Spare fuses, plastic tweezers and details of the fuse assignment are located in the compartment for the onboard tool kit.

# Giving and receiving assistance

## Receiving assistance

The Roadside Assistance of the BMW Group offers you assistance in the event of a breakdown around the clock, also at weekends and on public holidays.

The phone numbers of the Roadside Assistance control center in your home country can be found in the BMW Dealer Directory.

In the case of vehicles with the corresponding equipment, you can use buttons in the headlining to contact Roadside Assistance or start an emergency call.

When an emergency call is started, a telephone connection is set up to the general emergency call center.

In vehicles where BMW Assist is enabled, the phone system will also automatically establish contact with the BMW Assist emergency call center. If the current location of your vehicle can be determined, this is transferred to the BMW Assist emergency call center.

The condition for starting an emergency call or contacting Roadside Assistance:

- ▶ The car phone is logged on to a mobile telephone network
- ▶ The emergency call system is operable.

## Starting an emergency call\*

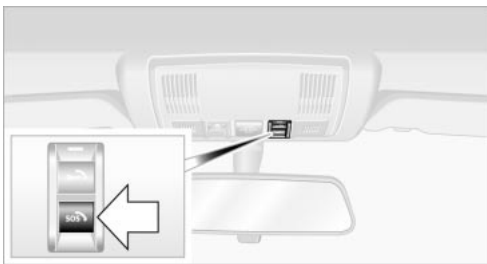

Press button, refer to arrow, for at least 2 seconds.

The indicator lamp above the buttons lights up. As soon as the voice connection to the general emergency number has been set

up, the indicator lamp flashes.

If the indicator lamp flashes, but you are unable to hear the emergency call center, you can still be heard by the emergency call center.

 For technical reasons, the emergency call cannot be guaranteed under unfavorable conditions. ◀

Under certain conditions, an emergency call is started automatically immediately after a severe accident. The automatic emergency call is not affected by the button being pressed.

## Roadside Assistance\*

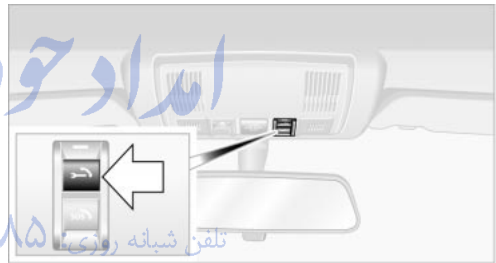

Press button, refer to arrow, for at least 2 seconds.

The indicator lamp above the buttons lights up. As soon as the voice connection to Roadside Assistance has been set up, the indicator lamp flashes.

On a country-specific basis, with BMW Assist enabled, the current location of your vehicle is determined at the same time.

## Warning triangle\*

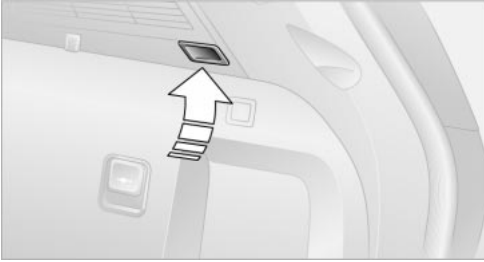

To open the side trim panel: press the button.

**!** Comply with legal requirements requiring you to carry a hazard warning triangle in the vehicle. ◀

## First-aid kit\*

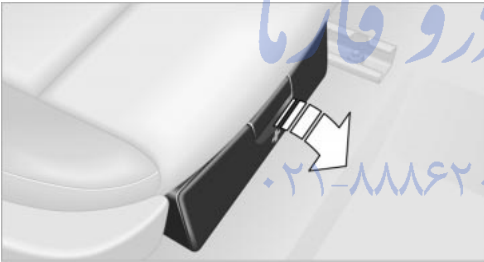

Beneath the front passenger's seat.

To open: pull the handle and fold the cover downward.

To close: fold the cover up.

**!** Some of the articles in the first-aid kit may be used within a limited time only. For this reason, check the expiration dates of each of the items regularly, and replace any whose expiration dates have passed. You can find replacements in any pharmacy.

Always observe all legal regulations requiring a first-aid kit to be carried in the vehicle. ◀

## Jump-starting

When your battery is discharged you can use two jumper cables to start your vehicle with power from the battery in a second vehicle. You can also use the same method to help start another vehicle. Use only jumper cables with fully-insulated clamp handles.

**!** To avoid the risk of potentially fatal injury, always avoid all contact with electrical components while the engine is running. Carefully observe the following instructions to avoid personal injury and/or damage to one or both vehicles. ◀

### Preparing

1. Check whether the battery of the other vehicle has a voltage of 12 Volts and approximately the same capacitance in Ah. This information can be found on the battery
2. Switch off the engine of the support vehicle
3. Switch off any electrical systems and components in both vehicles.

**!** Ensure that no contact exists between the bodywork on the two vehicles, otherwise there is a danger of short circuits. ◀

### Connecting the jumper cables

**!** To avoid personal injury from sparks, always observe this sequence when connecting jumper cables. ◀

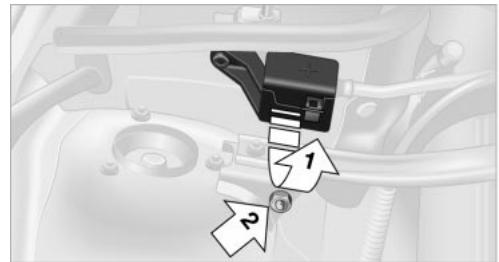

On your BMW, the auxiliary terminal for jump-starting in the engine compartment serves as the battery positive terminal, refer also to Engine compartment overview

on page 93. The symbol + is embossed on the cover.

1. Open the cover of the BMW auxiliary terminal for jump-starting, refer to arrow 1
2. Connect one terminal clamp of the positive/+ jumper cable to the positive terminal of the battery or a auxiliary terminal of the vehicle providing starting assistance
3. Connect the second terminal clamp of the positive/+ jumper cable to the positive terminal of the battery or to a auxiliary terminal of the vehicle to be started. On your BMW, there is a special nut as body ground or negative terminal on the suspension strut dome, refer to arrow 2
4. Attach one end of the jumper cable minus/- to the negative terminal of the battery or to an engine or body ground of the vehicle providing assistance
5. Connect the second terminal clamp of the negative/- jumper cable to the negative terminal of the battery or to the engine or body ground of the vehicle to be started.

## Starting the engine

1. Start the support vehicle's engine and let it run at an increased idling speed for a few minutes
2. Start the engine on the other vehicle in the usual way.  
If the first start attempt is not successful, wait a few minutes before another attempt in order to allow the discharged battery to recharge
3. Allow the engines to run for several minutes
4. Disconnect the jumper cables by reversing the connection sequence.

If necessary, have the battery checked and recharged at a BMW Sports Activity Vehicle Center.

 Never use spray fluids to start the engine. ◀

## Towing

 Always observe all applicable towing laws and regulations. Do not tow the BMW X3 with the axle raised, as otherwise the transfer case can be damaged. ◀

### Towing with a commercial tow truck

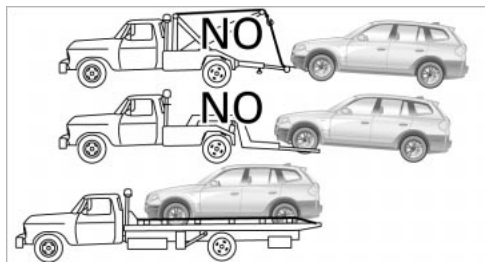

- ▷ Use only a flatbed carrier
- ▷ Do not tow with sling-type equipment
- ▷ Do not use a wheel lift.

 Never allow passengers to ride on a towed vehicle for any reasons. ◀

### Tow fitting

The threaded tow fitting is stored in the tool kit mounted on the inside of the compartment and should always remain in the vehicle. This fitting is designed for installation in the tow sockets located at the front and rear of the vehicle.

### Access to tow sockets

#### Front



Use a screwdriver to lever out the cover upward at the recess.

Rear



Use a screwdriver to lever out the cover upward at the recess.

**⚠** Only use the tow fitting that comes with the vehicle and screw it in as far as it will go. Only use the tow fitting to tow on the roadway. Adhere to these specifications, as otherwise the tow fitting can be torn out and damage the vehicle. Never attempt to tow or tie down the vehicle using suspension components, as this could lead to damage that might ultimately result in an accident. ◀

تلفن شبانه روزی: ۰۸۵-۸۸۸۶۲-۰۲۱

FarmaSOS.com



# امداد خودرو فارما

تلفن شبانه روزی: ۰۲۱-۸۸۸۶۲۰۸۵

[FarmaSOS.com](http://FarmaSOS.com)



# امداد خودرو فارما

تلفن شبانه روی: ۰۲۱-۸۸۸۶۲۰۸۵

[FarmaSOS.com](http://FarmaSOS.com)

## Reference

This is where to look to find information on any desired topic as quickly as possible.

This chapter includes the section with technical information as well as the manual's index.

امداد خودرو فارما

تلفن شبانه روزی: ۰۲۶-۸۸۸۶۲۰۸۵

FarmaSOS.com

# Technical data

## Engine specifications

		BMW X3 2.5i	BMW X3 3.0i
Displacement	cu in/cm <sup>3</sup>	152.2/2,494	181.8/2,979
Number of cylinders		6	6
Maximum output at engine speed	hp rpm	184 6,000	225 5,900
Maximum torque at engine speed	lb ft/Nm rpm	175/237 3,500	214/290 3,500
Compression ratio	ε	10.5	10.2
Stroke	in/mm	2.95/75	3.53/89.6
Bore	in/mm	3.31/84	3.31/84
Fuel-injection system	Digital electronic engine-management system DME		

An engine performance test is authorized only on an appropriate chassis dynamometer.

امداد خودرو فارما

تلفن شبانه روزی: ۰۲۱-۸۸۸۶۲۰۸۵

FarmaSOS.com

## Dimensions

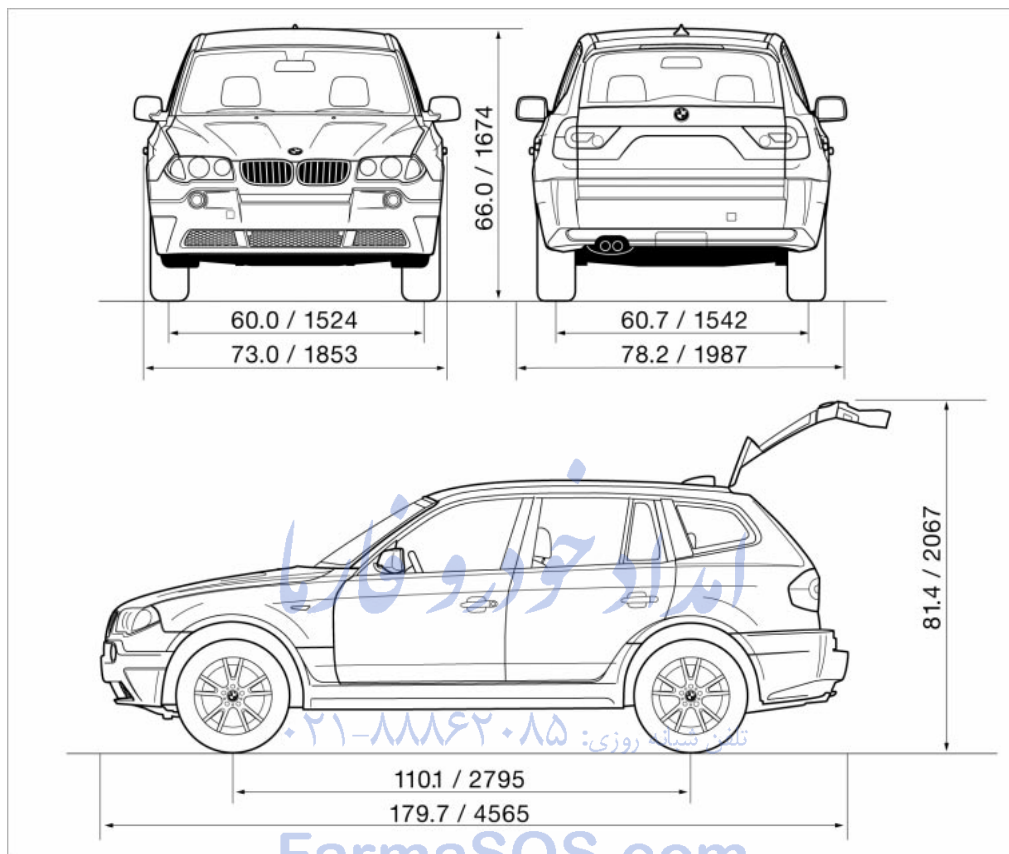

All dimensions in inches/millimeters. Smallest turning circle dia.: 38.4 ft/11.7 m.  
Height with roof railing\*: 66.0 in/1,674 mm.

## Weights

		BMW X3 2.5i	BMW X3 3.0i
Curb weight			
with manual transmission	lbs/kg	4,001/1,815	4,023/1,825
with automatic transmission	lbs/kg	4,045/1,835	4,067/1,845
Approved gross vehicle weight			
with manual transmission	lbs/kg	4,993/2,265	5,049/2,290
with automatic transmission	lbs/kg	5,049/2,290	5,104/2,315
Load			
with manual transmission	lbs/kg	992/450	1,025/465
with automatic transmission	lbs/kg	1,003/455	1,036/470
Approved front axle load	lbs/kg	2,425/1,100	2,425/1,100
Approved rear axle load	lbs/kg	2,756/1,250	2,778/1,260
Approved roof load capacity	lbs/kg	165/75	165/75
Cargo area capacity	cu ft/l	71/2,010	71/2,010

Never exceed either the approved axle loads or the gross vehicle weight.

امداد خودرو فارما

تلفن شبانه روزی: ۰۸۵-۸۸۸۶۲-۰۲۱

FarmaSOS.com

## Capacities

			Notes
Fuel tank	gal./liters	approx. 17.7/67	Fuel specification:
Reserve	gal./liters	approx. 2/8	page 85
Windshield / Headlamp washer system	quarts/liters	approx. 6.9/6.5	For details: page 94
Cooling system including heater	quarts/liters	10.6/10.0 for manual transmission 10.8/10.2 for automatic transmission	For details: page 95
Engine oil and filter change	quarts/liters	approx. 6.6/6.2	For details: page 94
Manual, automatic transmission and differential		→	Lifetime fluid, no fluid change required

امداد خودرو فارما

تلفن شبانه روزی: ۰۸۵-۸۸۸۶۲-۰۲۱

FarmaSOS.com

# امداد خودرو فارما

تلفن شبانه روزی: ۰۲۱-۸۸۸۶۲۰۸۵

**FarmaSOS.com**



# Everything from A to Z

## Index

### A

A/C operation

- air conditioner 60
- automatic climate control 63

ABS Antilock Brake System 50

- indicator lamp 50

Accessories 6

Activated-charcoal filter 65

Adaptive Head Light 57

Adding engine oil 95

Adjusting seats 27

- electric 29
- mechanical 28

Air, drying, refer to A/C operation 61, 64

Airbags 54

- deactivating 34
- indicator lamp 55
- sitting safely 27

Air circulation, refer to

Recirculated-air mode 61, 64

Air conditioner 60, 63

Air distribution

- air conditioner 61
- automatic climate control 64

Airing, refer to

Ventilation 61, 65

Air outlets, refer to

Ventilation 61, 65

Air pressure, refer to Tire inflation pressure 86

Air supply

- air conditioner 61
- automatic climate control 64

Air vents, refer to

Ventilation 61, 65

AKI, refer to Fuel specifications 85

Alarm system 24

- avoiding unintentional alarms 25

Anchorage 73

Antifreeze

- coolant 95
- washer fluid 94

Antifreeze protection

- coolant 95

Anti-theft alarm system 18

- refer to Alarm system 24

Anti-trapping mechanism

- panorama glass roof 24
- power windows 22

Approved engine oils 95

Approved gross vehicle weight 116

Armrest 68

- front 68

- rear 68

Artificial leather, refer to

Caring for your vehicle brochure

Ashtray 69

- front 69

- rear 69

AUC Automatic

recirculated-air control 64

Automatic

- air distribution 64
- air supply 64

Automatic car wash, refer

to Caring for your vehicle brochure

Automatic climate

control 63

Automatic cruise control 43

Automatic curb monitor 32

Automatic headlamp

control 57

Automatic program, refer to

automatic air-distribution 64

Automatic rear window cleaning 43

Automatic recirculated-air control AUC 64

Automatic transmission

- malfunction 41

Automatic transmission

with Steptronic 39

- indicator lamp 41

- interlock 37

- selector lever interlock 40

- shiftlock 40

Average fuel

consumption 48

Average speed 48

Avoiding unintentional alarms 25

Axle load, permitted 116

### B

Backrests, refer to

Adjusting seats 28

Backup lamps 39

- replacing bulbs 102

Bad roads 80

Bar, towing 109

Batteries, disposal 106

Battery 105

- indicator lamp 12, 105

- jump-starting 108

Belts, refer to Safety

belts 30

Beverage holders 67

Black ice, refer to Ice

warning 47

Blower

- air conditioner 61

- automatic climate

control 64

BMW maintenance

system 97

BMW sports seat 28

Bore, refer to Engine

data 114

Bottle holder, refer to  
 Beverage holders **67**  
 Brake fluid **96**  
 - indicator lamp **96**  
 - level **96**  
 - replacing **96**  
 Brake force display **54**  
 Brake lamps  
 - defect **57**  
 - indicator lamp **12**  
 - replacing the bulbs **102**  
 Brake pads and rotors  
 - breaking-in procedure **76**  
 Brakes **77, 96**  
 - ABS **77**  
 - brake fluid **96**  
 - break-in procedure **76**  
 - handbrake **38**  
 - indicator/warning lamp **38**  
 Brake system  
 - brake-fluid level **96**  
 - brake pads **96**  
 - corrosion **77**  
 - disc brakes **76, 77**  
 - indicator lamp **96**  
 - rotors **76, 77**  
 Brake wear warning  
 - brake pads **96**  
 - indicator lamp **96**  
 Break-in procedures **76**  
 Bulbs and lamps **99**  
 Buttons in steering wheel **14**

## C

California Proposition  
 65 Warning **98**  
 Capacities **117**  
 Car care, refer to Caring for your vehicle brochure  
 Car-care products, refer to Caring for your vehicle brochure  
 Care, refer to Caring for your vehicle brochure

Cargo area **71**  
 - capacity **116**  
 - cover **71**  
 - floor cover **72**  
 - folding rear seat backrest **71**  
 - increasing volume **71**  
 - lashing eyes **73**  
 - manual unlocking **21**  
 - opening, remote control **19**  
 - opening/closing **21**  
 - opening from the outside **21**  
 - sockets **73**  
 - volume **116**  
 Cargo bay, refer to Cargo area **71**  
 Cargo loading **78**  
 Caring for leather, refer to Caring for your vehicle brochure  
 Caring for the carpet, refer to Caring for your vehicle brochure  
 Caring for the vehicle finish, refer to Caring for your vehicle brochure  
 Car keys, refer to Key set **18**  
 Car phone preparation **70**  
 Car wash **77**  
 Car wash, refer to Caring for your vehicle brochure  
 Catalytic converter, refer to High temperatures **76**  
 Central locking system **18**  
 - interior **20**  
 Changes, technical, refer to For your own safety **6**  
 Changing a wheel **103**  
 Check Gas Cap  
 - indicator lamp **12, 84**  
 Checking inflation pressure **86**  
 Child's seats, refer to Child-restraint systems **34**  
 Child-restraint systems **34**  
 Child-safety locks **36**  
 Chock **103**

Chrome parts, care, refer to Caring for your vehicle brochure  
 Cigarette lighter  
 - front **69**  
 - rear **69**  
 Circulation of air, refer to Recirculated-air mode **61, 64**  
 Cleaning, vehicle, refer to Caring for your vehicle brochure  
 Cleaning the windshield **42**  
 Cleaning windows, reservoir **94**  
 Clean the rear window **42**  
 Clock **46**  
 - 12/24 hour mode **48**  
 - setting, refer also to Owner's Manual for Radio/Onboard computer **46**  
 Clutch **76**  
 - breaking in **76**  
 Cockpit **10**  
 Cold start, refer to Starting the engine **37**  
 Comfort operation panorama glass roof **20**  
 Compact wheel  
 - wheel changes **103**  
 Compression ratio, refer to Engine data **114**  
 Computer **47**  
 Computer, functions **48**  
 Condensation, refer to A/C operation **61, 64**  
 Connecting a vacuum cleaner, refer to Lighter socket **69**  
 Consumption, refer to Average fuel consumption **48**  
 Consumption indicator, refer to Fuel gauge **45**  
 Contents **3**  
 Controls, refer to Cockpit **10**  
 Convenience operation  
 - from outside **20**  
 - windows **20**

Coolant **95**  
 - indicator lamp **95**  
 - level **96**  
 - temperature gauge **45**  
 Coolant temperature gauge **45**  
 Cooling, refer to Temperature **61**  
 Copyright **2**  
 Cruise control  
 - buttons in steering wheel **14**  
 - indicator lamp **43**  
 Cruise control, refer to  
 - Programmable cruise control **43**  
 Cruising range **48**  
 Cup holder, refer to Beverage holders **67**  
 Curb weight **116**  
 Cylinders, refer to Engine data **114**

## D

Dashboard system, refer to Cockpit **10**  
 Data, technical  
 - dimensions **115**  
 - engine **114**  
 - filling capacities **117**  
 - weights **116**  
 Daytime driving lamp **57**  
 DBC Dynamic Brake Control **50**  
 - indicator lamp **50**  
 Decommissioning the vehicle, refer to Caring for your vehicle brochure **97**  
 Defect, refer to Manual operation  
 Defects **7**  
 Defrosting, windows **61**  
 - air conditioner **62**  
 - automatic climate control **64**  
 - rear window defroster **61, 65**  
 Defrosting windows and removing condensation  
 - air conditioner **62**  
 - automatic climate control **64**  
 Defrosting windshield, refer to Defrosting windows **62, 64**  
 Defrost position, refer to Defrosting windows **62, 64**  
 Digital clock **46**  
 Dimensions **115**  
 Dipstick, engine oil **94**  
 Directional indicators, refer to Turn signal indicators **41**  
 Discs brakes **76, 77**  
 Displacement, refer to Engine data **114**  
 Display lighting, refer to Instrument lighting **58**  
 Displays, refer to Instrument cluster **11**  
 Disposal  
 - batteries **106**  
 - oil **95**  
 Doors  
 - locking and unlocking **20**  
 - manual operation **20**  
 DOT Quality Grades **88**  
 Draft-free ventilation **61, 65**  
 Drawbar support load **116**  
 Driving lamps, refer to Parking lamps/low beams **57**  
 Driving notes **76**  
 Driving on bad roads **80**  
 Driving stability control systems **50**  
 Driving through water **80**  
 DSC Dynamic Stability Control **50**  
 - indicator lamp **51**

## E

Electrical malfunction  
 - door lock **20**  
 - doors **20**  
 - driver's door **20**  
 - fuel filler door **84**  
 - panorama glass roof **24**  
 - tailgate **21**  
 Electric power windows **22**  
 Electronic Stability Program ESP, refer to Dynamic Stability Control **50**  
 Emergency actuation, refer to Manual operation  
 Emergency call **107**  
 Engine  
 - breaking in **76**  
 - data **114**  
 - indicator lamp **37**  
 - malfunction in electronic circuitry **38**  
 - speed **45**  
 Engine compartment **93**  
 Engine coolant **95**  
 Engine hood **92**  
 Engine oil **95**  
 - indicator/warning lamp **94**  
 - prescribed oils **95**  
 Engine oil grades **95**  
 Engine oil level **94**  
 - indicator/warning lamp **94**  
 Engine oil pressure **94**  
 - indicator/warning lamp **94**  
 Engine oil sensor **94**  
 - indicator/warning lamp **94**  
 Engine output, refer to Engine data **114**  
 Engine temperature, refer to Coolant temperature **45**  
 Equipment range, refer to Service and Warranty Information Booklet for

US models, Warranty and Service Guide Booklet for Canadian models  
 ESP Electronic Stability Program, refer to DSC Dynamic Stability Control **50**  
 Exhaust system, refer to High temperatures **76**  
 Exterior mirror  
 - automatic dimming feature **32**  
 Exterior mirrors **31**

## F

Fan, refer to Air supply **61, 64**  
 Filling the windshield washer reservoir **94**  
 Filter  
 - refer to Microfilter **62**  
 - refer to Microfilter/Activated charcoal filter **65**  
 First-aid kit **108**  
 Fittings, tow-starting and towing **109**  
 Flat tire **103**  
 - compact wheel **103**  
 - Flat Tire Monitor **53**  
 Flat Tire Monitor **53**  
 - indicator lamp **53**  
 Flooding, refer to Driving on bad roads **80**  
 Floor cover **72**  
 Fluid level  
 - indicator lamp **94**  
 Fog lamps **58**  
 - replacing bulbs **102**  
 Folding rear seat back **71**  
 Folding rear seat backrest **71**  
 Footbrake, refer to Brake system **77, 96**  
 Footbrake, refer to General driving notes **77, 96**  
 Front/rear reading lamps **58**  
 Front airbags **54**  
 Front center armrest **68**

Front seat adjustment **27**  
 Fuel **85**  
 - average fuel consumption **48**  
 - capacity **117**  
 - gauge **45**  
 - quality **85**  
 - volume **48**  
 Fuel capacity **117**  
 Fuel clock, refer to Fuel gauge **45**  
 Fuel display, refer to Fuel gauge **45**  
 Fuel filler cap **84**  
 Fuel filler door **84**  
 - releasing in the event of electrical defect **84**  
 Fuses **106**

## G

Garage-door opener, refer to Integrated universal remote control **66**  
 Gasoline, refer to Fuel quality **85**  
 Gasoline consumption, refer to Average fuel consumption **48**  
 Gasoline display, refer to Fuel gauge **45**  
 Gear changes, refer to Automatic transmission with Steptronic **40**  
 Gear display **41**  
 Gear lever  
 - automatic transmission with Steptronic **39**  
 - manual transmission **39**  
 General driving notes **76**  
 Glove compartment **68**  
 Grills, refer to Ventilation **61, 65**  
 Ground clearance **80**

## H

Halogen lamps **100**  
 Handbrake  
 - indicator lamp **38**

Hands-free microphone, refer to Car phone preparation **70**  
 Hands-free system **70**  
 Hazard warning flashers **10**  
 HDC Hill Descent Control **51**  
 Headlamp control, automatic **57**  
 Headlamp flasher **41**  
 - indicator lamp **41**  
 Headlamps **100**  
 - bulb replacement **99**  
 Headlamps, care, refer to Caring for your vehicle brochure  
 Headlamp washer reservoir **94**  
 Headlamp washer system **94**  
 - cleaning headlamps **42**  
 - tank capacity, refer to Filling capacities **117**  
 - washer fluid **94**  
 Head restraints **28**  
 Heated mirrors **32**  
 Heated rear window  
 - air conditioner **61**  
 automatic climate control **65**  
 Heated seats **30**  
 Heated steering wheel **31**  
 Heated windshield, automatic climate control **64**  
 Heating  
 - exterior mirror **32**  
 - rear window **61, 65**  
 - seats **30**  
 - steering wheel **31**  
 Heating and ventilation **60, 63**  
 Heavy cargo, refer to Cargo loading **78**  
 Height, refer to Dimensions **115**  
 Height adjustment  
 - seats **28**  
 - steering wheel **31**

High beams  
– bulb replacement **100**  
– headlamp flasher **58**  
– indicator lamp **12**  
High Performance  
Synthetic Oil **95**  
Hill-climbing ability, refer to  
Driving on bad roads **80**  
Hill descent assistance,  
refer to HDC **51**  
Hill Descent Control  
HDC **51**  
Hills **77**  
Holder for beverage  
cans **67**  
Horn **10**  
Hydraulic Brake Assistant,  
refer to DBC **50**  
Hydroplaning **77**

## I

Ice warning **47**  
Ignition **37**  
Ignition key **18**  
Ignition lock **37**  
Imprint **2**  
Indicator/warning lamp  
– airbags **55**  
– alarm system **25**  
– brake system **96**  
– DSC **51**  
– Flat Tire Monitor **53**  
– fog lamps **58**  
– reserve **45**  
– safety belt warning **30**  
Indicator/warning lamps **12**  
Individual settings, refer to  
Vehicle Memory, Key  
Memory **33**  
Inflation pressure, tires **86**  
Inflation pressure  
monitoring, refer to Flat  
Tire Monitor **53**  
Instrument cluster **10, 11**  
Instrument illumination **58**  
Instrument lighting **58**  
Integrated universal remote  
control **66**  
Interior lamps **58**

Interior mirror  
– automatic dimming  
feature **32**  
Interior motion  
sensor **22, 25**  
– switching off **19**  
Interior rearview mirror **32**  
Interlock, refer to Ignition  
lock **37**  
Intermittent  
– operation, wipers **41**

## J

Jacking points **104**  
Jumping, refer to Jump-  
starting **108**  
Jump-starting **108**

## K

Key Memory **33**  
Keys **18**  
Kickdown **40**

## L

Lamps and bulbs **99**  
Lashing eyes, refer to  
Securing the load **79**  
Leather care, refer to  
Caring for your vehicle  
brochure  
LEDs light-emitting  
diodes **103**  
License plate lamp  
– bulb replacement **102**  
Lifting handle, compact  
wheel **104**  
Light-alloy wheels, care,  
refer to Caring for your  
vehicle brochure  
Light-emitting diodes  
LEDs **103**  
Lighter **69**  
Lighter socket **69**  
Lighting of instruments **58**  
Lighting of the instruments,  
refer to Instrument  
lighting **58**

Lights, refer to Parking  
lamps/low beams **57**  
Lights on warning **57**  
Load, refer to Loading **78**  
Loading  
– securing the load **79**  
– stowing cargo **79**  
– vehicle **78**  
Loading area  
– lid, refer to Tailgate **21**  
Load securing devices **79**  
Locking  
– from inside **20**  
– from outside **18**  
Locking and unlocking  
doors  
– from inside **20**  
– from outside **18**  
Longlife oils  
– approved oils **95**  
Low beams **57**  
– automatic **57**  
– bulb replacement **100**  
– indicator lamp **57**  
Low-fuel warning light,  
refer to Fuel gauge **45**  
Lug bolts **104**  
Luggage compartment,  
refer to Cargo area  
Luggage rack, refer to  
Roof-mounted luggage  
rack **79**  
Lumbar support **29**

## M

Maintenance **97**  
Maintenance system,  
BMW **97**  
Malfunction in automatic  
transmission system **41**  
Manual operation  
– doors **20**  
– driver's door **20**  
– fuel filler door **84**  
– glass roof **24**  
– panorama glass roof **24**  
– tailgate **21**  
Manual transmission **39**  
Master keys with remote  
control **18**

Maximum axle loads [116](#)  
 Maximum roof weight [116](#)  
 MD operation, refer to  
     Owner's Manual for  
     Radio/Onboard computer  
 Mechanical seats [28](#)  
 Memory, refer to Seat and  
     mirror memory [29](#)  
 Memory, refer to Vehicle  
     Memory, Key Memory [33](#)  
 Microfilter  
     - air conditioner [62](#)  
     - automatic climate  
         control [65](#)  
 Microphone, refer to Car  
     phone preparation [70](#)  
 Microphone for  
     telephone [70](#)  
 Mileage, refer to Engine  
     data [114](#)  
 Mini-Disc operation, refer  
     to Owner's Manual for  
     Radio/Onboard computer  
 Mirror  
     - automatic curb  
         monitor [32](#)  
     - mirror heating [32](#)  
     - mirror memory, refer to  
         Seat and mirror  
         memory [29](#)  
 Mirror dimming feature [32](#)  
 Mirrors [31](#)  
 Mobile Service, refer to  
     Roadside Assistance [107](#)  
 Modifications, technical [6](#)  
 Multifunction switch  
     - turn signal indicators/  
         headlamp flasher [41](#)  
     - washer/wiper system [41](#)

## N

Neck support, refer to Head  
     restraints [28](#)  
 Next Service  
     indicator [46](#), [97](#)  
 Nozzles, refer to  
     Ventilation [61](#), [65](#)  
 Nylon rope [109](#)

## O

OBD connector [98](#)  
 Octane number, refer to  
     Fuel quality [85](#)  
 Odometer [45](#)  
 Oil  
     - approved engine oils [95](#)  
     - dipstick [94](#)  
 Oil change interval, refer to  
     Next Service indicator [97](#)  
 Oil change interval, refer to  
     Service Manual  
 Oil consumption [94](#)  
 Oil grades [95](#)  
 Oil level [94](#)  
 Oil pressure [94](#)  
 Oil sensor  
     - indicator lamp [94](#)  
 OILSERVICE [46](#), [97](#)  
 Onboard Diagnostic OBD  
     interface socket [98](#)  
 Onboard tool kit [99](#)  
 Opening and closing [18](#)  
     - from inside [20](#)  
     - from outside [18](#)  
     - using the door lock [20](#)  
     - using the remote  
         control [18](#)  
 Operating on bad roads [80](#)  
 Output, refer to Engine  
     data [114](#)  
 Outside air [61](#)  
     - air conditioner [61](#)  
     - automatic climate  
         control [64](#)  
 Outside temperature  
     display  
     - changing unit of  
         measure [47](#)  
     - in computer [47](#)  
 Overview indicator/warning  
     lamps [12](#)

## P

Package tray, refer to  
     Cargo area [71](#)

Panorama glass roof [23](#)  
     - comfort operation [20](#)  
     - manual operation [24](#)  
     - protective function [24](#)  
 Park Distance Control  
     PDC [49](#)  
 Parking  
     - vehicle [38](#)  
 Parking aid, refer to Park  
     Distance Control PDC [49](#)  
 Parking brake, refer to  
     Handbrake [38](#)  
 Parking lamps [57](#)  
     - bulb replacement [101](#)  
 Parking lamps/low  
     beams [57](#)  
 Parking the vehicle [38](#)  
 Particulate filter, refer to  
     Microfilter [62](#)  
 Partition net [72](#)  
 PDC Park Distance  
     Control [49](#)  
 Plastic, refer to Caring for  
     your vehicle brochure  
 Pollen, refer to  
     Microfilter [62](#)  
 Pollen, refer to Microfilter/  
     Activated charcoal  
     filter [65](#)  
 Power seat [29](#)  
 Pressure, tires [86](#)  
 Pressure monitoring,  
     tires [53](#)  
     - Flat Tire Monitor [53](#)  
 Programming settings,  
     refer to Vehicle Memory,  
     Key Memory [33](#)  
 Protective function  
     - panorama glass roof [24](#)  
 Puncture  
     - Flat Tire Monitor [53](#)

## R

Radiator, refer to  
     Coolant [95](#)  
 Radio, refer to separate  
     Owner's Manual  
 Radio navigation, refer to  
     separate Owner's Manual  
 Rain sensor [42](#)

Range  
– setting units 47  
Rear armrest, refer to  
– Center armrest 68  
Rear backrests  
– folding 71  
Rear center armrest 68  
Rear fog lamps  
– bulb replacement 102  
Rear lamps  
– bulb replacement 102  
Rear seat back  
– folding 71  
Rearview mirrors  
– exterior 31  
Rear window defroster  
– air conditioner 61  
– automatic climate control 65  
Rear window safety switch 22  
Rear window wiper 43  
Recirculated-air mode  
– air conditioner 61  
– automatic climate control 64  
Reclining seat 28  
Refueling 84  
– fuel filler door 84  
Remaining distance to next vehicle service 46  
Remote control  
– fault 19  
– garage-door opener 66  
– tailgate 19  
Removing condensation, windows  
– air conditioner 62  
– automatic climate control 64  
Replacement fuses 106  
Replacement of tires  
– wheel changes 103  
Replacement tire 103  
Replacing bulbs, refer to  
– Lamps and bulbs 99  
Replacing light bulbs 99  
Reporting safety defects 7  
Reservoir, washer system 94

Restraint systems, refer to  
– Safety belts 30  
Reverse 39  
Reverse gear  
– automatic transmission with Steptronic 40  
– manual transmission 39  
Rims 90  
Roadside Assistance 107  
Roll-up cover, refer to  
– Cargo area cover 71  
RON, refer to Fuel quality 85  
Roof-mounted luggage rack 79  
Rope, refer to Tow-starting and towing 109  
Rotating coin holder, refer to Storage compartments 68

**S**  
Safe sitting position with safety belts 27  
Safety belts 30  
– sitting safely 27  
– warning lamp 30  
Safety belt tensioners, refer to Safety belts 27  
Safety belt warning  
– indicator lamp 30  
Safety defects, reporting 7  
Safety feature  
– power windows 22  
Safety systems, refer to  
– ABS Antilock Brake System 50  
Safety systems, refer to  
– DSC Dynamic Stability Control 50  
Screwdriver, refer to  
– Onboard tool kit 99  
Seat, electric power 29  
Seat heating 30  
Seat memory, refer to Seat and mirror memory 29  
Securing cargo 79  
Selector lever, automatic transmission 40

Selector lever interlock, refer to Shiftlock 40  
Service and warranty notes 7  
Service Engine Soon 38, 98  
Service Interval Display 46, 97  
Setting the units 47  
Setting units 47  
Shiftlock, changing the selector-lever positions 40  
Side airbags 54  
Side lamps 57  
Side tilt 80  
Side turn signal indicators  
– bulb replacement 101  
Sitting safely 27  
– with airbag 27  
– with safety belts 27  
Ski bag 70  
Smokers' package, refer to  
– Ashtray 69  
Sockets 69, 73  
SOS, refer to Starting an emergency call 107  
Spare fuses 106  
Spare key 18  
Spare tire, refer to Wheel changes 103  
Special oils, refer to  
– Approved oils 95  
Special washing program 42  
Specified oils 95  
Speedometer 11  
Speedometer, refer to  
– Instrument cluster 11  
Sport program  
– automatic transmission with Steptronic 40  
Sports seat 28  
Stability control, refer to  
– DSC Dynamic Stability Control 50  
Standing lamps 58  
Starting, engine 37  
Starting, refer to Starting the engine 37

- Starting assistance, refer to
    - Jump-starting 108
  - Starting difficulties
    - temperature 38
  - Starting-off assistance, DSC 50
  - Starting the engine 38
  - Startup difficulties
    - jump-starting 108
  - Status of this Owner's Manual at time of printing 5
  - Steering lock 37
  - Steering wheel 10, 14
    - adjustment 31
    - lock 37
  - Steering wheel heater 31
  - Steering wheel with buttons 14
  - Steptronic 39
  - Storage compartments 68
  - Storage package 68
  - Storage package nets 68
  - Storage space, refer to Cargo area 71
  - Storing seat position, refer to Seat and mirror memory 29
  - Storing the seat adjustment 29
  - Straps, refer to Loading 78
  - Stroke, refer to Engine data 114
  - Supply reservoir cleaning systems 94
  - Switches, refer to Cockpit 10
  - Switching off the engine 38
  - Symbols 4
- T**
- Table of contents 3
  - Tachometer 45
  - Tailgate
    - closing 21
    - emergency operation 21
    - opening from the outside 21
    - remote control 19
  - Tailgate lamp
    - bulb replacement 103
  - Tail lamps
    - bulb replacement 102
    - indicator lamp 57
  - Tank capacity 117
  - Technical modifications 6
  - Telephone, refer to separate Owner's Manual
  - Temperature
    - air conditioner 61
    - automatic climate control 64
  - Temperature, tires 88
  - Temperature display
    - ice warning 47
    - outside temperature 47
    - setting the units 47
  - Temperature gauge 45
  - Thigh support adjustment 28, 29
  - Three-point belt 30
  - Tightening torque 105
  - Tilt alarm sensor 25
    - switching off 25
  - Tilt function, passenger-side mirror 32
  - Tire inflation pressures 86
  - Tire pressure monitoring, refer to Flat Tire Monitor 53
  - Tires
    - age 88
    - break-in procedure 76
    - changing 89
    - condition 89
    - DOT Quality Grades 88
    - flat 103
    - inflation pressure 86, 87
    - replacing 89
    - storage 90
    - temperature 88
    - traction 88
    - treadwear 88
    - Uniform Tire Quality Grading 89
    - wear indicators, refer to Tire tread/damage 89
    - wheel change 103
  - Tools, refer to Onboard tool kit 99
  - Torque of lug bolts 105
  - Tow bar 109
  - Tow fittings 109
  - Towing 109
  - Towing the vehicle 109
  - Tow rope 109
  - Tow sockets for tow fitting 109
  - Tow-starting 109
  - Track width, refer to Dimensions 115
  - Traction 88
  - Traction control
    - DSC 50
  - Trailer loads 116
  - Transmission 39
    - automatic transmission with Steptronic 39
    - manual transmission 39
  - Transmission lockout, refer to P Parking 40
  - Transmission malfunction 41
  - Transporting children 34
  - Transporting children safely 34
  - Tread depth, refer to Tire tread 89
  - Treadwear 88
  - Trip-distance counter, refer to Trip odometer 45
  - Trip odometer 45
  - Trunk, refer to Cargo area 71
  - Trunk lid, refer to Tailgate 21
  - Turning circle, refer to Dimensions 115
  - Turn signal indicators 41
    - bulb replacement 101
  - Turn signal indicators, side
    - bulb replacement 101
- U**
- Underbody protection, refer to Caring for your vehicle brochure
  - Uniform Tire Quality Grading 89



Units 47  
– outside temperature 47  
Universal garage-door  
opener, refer to  
Integrated universal  
remote control 66  
Universal remote  
control 66  
Unlocking  
– engine hood 92  
– from inside 21  
– from outside 19  
Upholstery care, refer to  
Caring for your vehicle  
brochure

## V

Vacuum cleaner  
connection 69  
Vehicle  
– battery 105  
– dimensions 115  
– loading 78  
Vehicle battery 105  
Vehicle jack 103  
Vehicle Memory 33  
Ventilation 61, 65  
– draft-free 61, 65  
Voice control, refer to  
separate Owner's Manual

## W

Warning and indicator  
lamps 12  
Warning triangle 108  
Warranty, refer to Service  
and Warranty Information  
Booklet for US models,  
Warranty and Service  
Guide Booklet for  
Canadian models 97  
Warranty and service  
notes 7  
Washer fluid 94  
Washer fluid reservoir, refer  
to Windshield/headlamp  
washer system 94  
Weights 116

Wheel/tire combination,  
refer to Replacing  
wheels/tires 89  
Wheelbase, refer to  
Dimensions 115  
Wheel bolts  
– wrench 103  
Wheel changes  
– compact wheel 103  
Wheels and tires 90  
Width, refer to  
Dimensions 115  
Windows 22  
– convenience operation 20  
Window wipers  
– replacing 99  
Windshield  
– cleaning 42  
Windshield washer  
– washer fluid 94  
Windshield washer system  
– washer/wiper system 41  
Windshield wiper blade  
replacement 99  
Windshield wipers, refer to  
Wiper/washer system 41  
Winter tires  
– changing 103  
– condition 89  
– storage 90  
Wiper/washer reservoir 94  
Wiper blade  
replacement 99  
Wiper system 94  
Working in the engine  
compartment 92  
Wrenches, refer to  
Onboard tool kit 99

## X

xDrive 51  
Xenon lamps 101  
– replacing the bulbs 101

# امداد خودرو فارما

تلفن شبانه روزی: ۰۲۱-۸۸۸۶۲۰۸۵

**FarmaSOS.com**

## Refueling

To ensure that you always have all the essential data at hand when refueling, we recommend that you fill in the following tables with the specifications and information that apply to your vehicle. Consult the index for individual specifications.

### Fuel

Designation

Please enter your preferred fuel here.

### Engine oil

Quality

The oil quantity between the two marks on the dipstick is approx. 1.1 US quarts/1 liter.

## Tire inflation pressures

	Summer tires Front	Rear	Winter tires Front	Rear
4 persons				
5 persons or 4 plus luggage				

تلفن شبانه روزی: ۰۲۱-۸۸۸۶۲۰۸۵

FarmaSOS.com

More about BMW



bmwusa.com

The Ultimate  
Driving Machine

# امداد خودرو فارما

تلفن شبانه روزی: ۰۸۵-۸۸۸۶۲-۰۲۱

**FarmaSOS.com**