

Contents

A-Z

Owner's Manual
for Vehicle



The Ultimate
Driving Machine®



FarmaSOS.com

THE BMW X6.

OWNER'S MANUAL.

BMW EfficientDynamics
Less emissions. More driving pleasure.

امداد خودرو فارما

تلفن شبانه روزی: ۰۲۱-۸۸۸۶۲۰۸۵

FarmaSOS.com

X6 **Owner's Manual for Vehicle**

Thank you for choosing a BMW.

The more familiar you are with your vehicle, the better control you will have on the road. We therefore strongly suggest:

Read this Owner's Manual before starting off in your new BMW. Also use the Integrated Owner's Manual in your vehicle. It contains important information on vehicle operation that will help you make full use of the technical features available in your BMW. The manual also contains information designed to enhance operating reliability and road safety, and to contribute to maintaining the value of your BMW.

Any updates made after the editorial deadline can be found in the appendix of the printed Owner's Handbook for Vehicle.

Supplementary information can be found in the additional brochures in the onboard literature.

We wish you a safe and enjoyable ride

BMW AG

امداد خودرو فارما

تلفن شبانه روزی: ۰۲۱-۸۸۸۶۲۰۸۵

FarmaSOS.com

The Owner's Manual is available in many countries as an app. Additional information on the Internet:

www.bmw.com/bmw_drivers_guide

امداد خودرو فارما

تلفن شبانه روزی: ۰۲۱-۸۸۸۶۲۰۸۵

FarmaSOS.com

© 2015 Bayerische Motoren Werke
Aktiengesellschaft

Munich, Germany

Reprinting, including excerpts, only with the written
consent of BMW AG, Munich.

US English VI/15, 07 15 490

Printed on environmentally friendly paper, bleached
without chlorine, suitable for recycling.

Contents

The fastest way to find information on a particular topic or item is by using the index, refer to page 254.

6 Information

At a glance

- 14 Cockpit
- 18 iDrive
- 26 Voice activation system
- 29 Integrated Owner's Manual in the vehicle

Controls

- 34 Opening and closing
- 52 Adjusting
- 62 Transporting children safely
- 67 Driving
- 82 Displays
- 101 Lights
- 106 Safety
- 134 Driving stability control systems
- 142 Driving comfort
- 164 Climate control
- 171 Interior equipment
- 180 Storage compartments

Driving tips

- 188 Things to remember when driving
- 192 Loading
- 195 Saving fuel

Mobility

- 204 Refueling
- 206 Fuel
- 208 Wheels and tires
- 219 Engine compartment
- 222 Engine oil
- 226 Coolant
- 228 Maintenance
- 230 Replacing components
- 238 Breakdown assistance
- 243 Care

Reference

- 250 Technical data
- 253 Appendix
- 254 Everything from A to Z

تلفن شبانه روزی: ۰۲۱-۸۸۸۶۲۰۸۵

FarmaSOS.com

Information

Using this Owner's Manual

Orientation

The fastest way to find information on a particular topic is by using the index.

An initial overview of the vehicle is provided in the first chapter.

Updates made after the editorial deadline

Any updates made after the editorial deadline can be found in the appendix of the printed Owner's Handbook for Vehicle.

User's manual for Navigation, Entertainment, Communication

The topics of Navigation, Entertainment, Communication and the short commands of the voice activation system are described in a separate user's manual, which is also included with the onboard literature.

Additional sources of information

A dealer's service center or another qualified service center or repair shop will be glad to answer additional questions at any time.

Information on BMW, e.g., on technology, is available on the Internet: www.bmwusa.com.

BMW Driver's Guide App

The Owner's Manual is available in many countries as an app. Additional information on the Internet:

www.bmw.com/bmw_drivers_guide

Symbols and displays

Symbols in the Owner's Manual

 Indicates precautions that must be followed precisely in order to avoid the possibility of personal injury and serious damage to the vehicle.

◀ Marks the end of a specific item of information.

 Refers to measures that can be taken to help protect the environment.

"..." Identifies display texts in vehicle used to select individual functions.

>...< Verbal instructions to use with the voice activation system.

>>...<< Identifies the answers generated by the voice activation system.

Action steps

Action steps to be carried out are presented as numbered list. The steps must be carried out in the defined order.

1. First action step.
2. Second action step.

Enumerations

Enumerations without mandatory order or alternative possibilities are presented as list with bullet points.

- ▷ First possibility.
- ▷ Second possibility.

Symbols on vehicle components

 Indicates that you should consult the relevant section of this Owner's Manual for information on a particular part or assembly.

Vehicle features and options

This Owner's Manual describes all models and all standard, country-specific and optional equipment that is offered in the model series. Therefore, in this Owner's Manual, we also describe and illustrate features that are not available in your vehicle, e.g., because of the selected optional features or the country-specific version.

This also applies to safety-related functions and systems.

The respectively applicable country provisions must be observed when using the respective features and systems.

For any options and equipment not described in this Owner's Handbook, refer to the Supplementary Owner's Handbooks.

On right-hand drive vehicles, some controls are arranged differently from what is shown in the illustrations.

Status of the Owner's Manual

Basic information

The manufacturer of your vehicle pursues a policy of constant development that is conceived to ensure that our vehicles continue to embody the highest quality and safety standards. In rare cases, therefore, the features described in this Owner's Manual may differ from those in your vehicle.

Updates made after the editorial deadline

Any updates made after the editorial deadline can be found in the appendix of the printed Owner's Handbook for Vehicle.

Own safety

Warranty

Your vehicle is technically configured for the operating conditions and registration requirements applying in the country of first delivery also known as homologation. If your vehicle is to be operated in a different country it might be necessary to adapt your vehicle to potentially differing operating conditions and permit requirements. If your vehicle does not comply with the homologation requirements in a certain country you may not be able to lodge warranty claims for your vehicle there. Further information on warranty is available from a dealer's service center.

Maintenance and repairs

Advanced technology, e.g., the use of modern materials and high-performance electronics, requires suitable maintenance and repair work.

The manufacturer of the vehicle recommends that you entrust corresponding procedures to a BMW dealer's service center. If you choose to use another service facility, BMW recommends use of a facility that performs work, e.g. maintenance and repair, according to BMW specifications with properly trained personnel, referred to in this Owner's Manual as "another qualified service center or repair shop".

If work is performed improperly, e.g. maintenance and repair, there is a risk of subsequent damage and related safety risks.

Parts and accessories

BMW recommends the use of parts and accessory products approved by BMW.

Approved parts and accessories, and advice on their use and installation are available from a BMW dealer's service center.

BMW parts and accessories were tested by BMW for their safety and suitability in BMW vehicles.

BMW warrants genuine BMW parts and accessories.

BMW does not evaluate whether each individual product from another manufacturer can be used with BMW vehicles without presenting a safety hazard, even if a country-specific official approval was issued. BMW does not evaluate whether these products are suitable for BMW vehicles under all usage conditions.

California Proposition 65 Warning

California laws require us to state the following warning:

Engine exhaust and a wide variety of automobile components and parts, including components found in the interior furnishings in a vehicle, contain or emit chemicals known to the State of California to cause cancer and birth defects and reproductive harm. In addition, certain fluids contained in vehicles and certain products of component wear contain or emit chemicals known to the State of California to cause cancer and birth defects or other reproductive harm. Battery posts, terminals and related accessories contain lead and lead compounds. Wash your hands after handling. Used engine oil contains chemicals that have caused cancer in laboratory animals. Always protect your skin by washing thoroughly with soap and water.

Service and warranty

We recommend that you read this publication thoroughly. Your vehicle is covered by the following warranties:

- ▷ New Vehicle Limited Warranty.
- ▷ Rust Perforation Limited Warranty.
- ▷ Federal Emissions System Defect Warranty.
- ▷ Federal Emissions Performance Warranty.
- ▷ California Emission Control System Limited Warranty.

Detailed information about these warranties is listed in the Service and Warranty Information

Booklet for US models or in the Warranty and Service Guide Booklet for Canadian models.

Your vehicle has been specifically adapted and designed to meet the particular operating conditions and homologation requirements in your country and continental region in order to deliver the full driving pleasure while the vehicle is operated under those conditions. If you wish to operate your vehicle in another country or region, you may be required to adapt your vehicle to meet different prevailing operating conditions and homologation requirements. You should also be aware of any applicable warranty limitations or exclusions for such country or region. In such case, please contact Customer Relations for further information.

Maintenance

Maintain the vehicle regularly to sustain the road safety, operational reliability and the New Vehicle Limited Warranty.

Specifications for required maintenance measures:

- ▷ BMW Maintenance system
- ▷ Service and Warranty Information Booklet for US models
- ▷ Warranty and Service Guide Booklet for Canadian models

If the vehicle is not maintained according to these specifications, this could result in serious damage to the vehicle. Such damage is not covered by the BMW New Vehicle Limited Warranty.

Data memory

Many electronic components on your vehicle are equipped with data memories that temporarily or permanently store technical information about the condition of the vehicle, events and faults. This technical information generally records the state of a component, a module, a system or the environment:

- ▷ Operating mode of system components, fill levels for instance.
- ▷ Status messages for the vehicle and from its individual components, e.g., wheel rotation speed/vehicle speed, deceleration, transverse acceleration.
- ▷ Malfunctions and faults in important system components, e.g., lights and brakes.
- ▷ Responses by the vehicle to special situations such as airbag deployment or engaging the stability control system.
- ▷ Ambient conditions, such as temperature.

This data is purely technical in nature and is used to detect and correct faults and to optimize vehicle functions. Motion profiles over routes traveled cannot be created from this data. When service offerings are used, e.g., repair services, service processes, warranty claims, quality assurance, this technical information can be read out from the event and fault memories by employees of the dealer's service center or another qualified service center or repair shop, including the manufacturer, using special diagnostic tools. You can obtain further information there if you need it. After an error is corrected, the information in the fault memory is deleted or overwritten on a continuous basis.

With the vehicle in use there are situations where you can associate these technical data with individuals if combined with other information, e.g., an accident report, damage to the vehicle, eye witness accounts — possibly with the assistance of an expert.

Additional functions that are contractually agreed with the customer - such as vehicle emergency locating - you can transmit certain vehicle data from the vehicle.

tions, such as an air bag deployment or hitting a road obstacle, data that will assist in understanding how a vehicle's systems performed. The EDR is designed to record data related to vehicle dynamics and safety systems for a short period of time, typically 30 seconds or less.

The EDR in this vehicle is designed to record such data as:

- ▷ How various systems in your vehicle were operating.
- ▷ Whether or not the driver and passenger safety belts were fastened.
- ▷ How far, if at all, the driver was depressing the accelerator and/or brake pedal.
- ▷ How fast the vehicle was traveling.

These data can help provide a better understanding of the circumstances in which crashes and injuries occur.

EDR data are recorded by your vehicle only if a nontrivial crash situation occurs; no data are recorded by the EDR under normal driving conditions and no personal data, e.g., name, gender, age, and crash location, are recorded.

However, other parties, such as law enforcement, could combine the EDR data with the type of personally identifying data routinely acquired during a crash investigation.

To read data recorded by an EDR, special equipment is required, and access to the vehicle or the EDR is needed. In addition to the vehicle manufacturer, other parties, such as law enforcement, that have the special equipment, can read the information if they have access to the vehicle or the EDR.

Event Data Recorder EDR

This vehicle is equipped with an event data recorder EDR. The main purpose of an EDR is to record, in certain crash or near crash-like situa-

Vehicle identification number

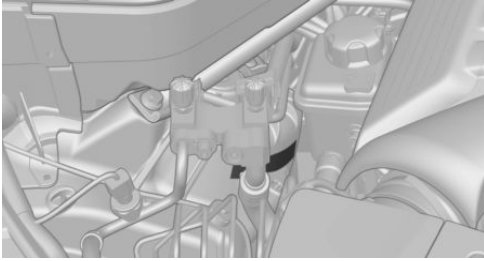

The vehicle identification number can be found in the engine compartment.

The vehicle identification number can also be found behind the windshield.

Reporting safety defects

For US customers

The following only applies to vehicles owned and operated in the US.

If you believe that your vehicle has a defect which could cause a crash or could cause injury or death, you should immediately inform the National Highway Traffic Safety Administration NHTSA, in addition to notifying BMW of North America, LLC, P.O. Box 1227, Westwood, New Jersey 07675-1227, Telephone 1-800-831-1117.

If NHTSA receives similar complaints, it may open an investigation, and if it finds that a safety defect exists in a group of vehicles, it may order a recall and remedy campaign.

However, NHTSA cannot become involved in individual problems between you, your dealer, or BMW of North America, LLC.

To contact NHTSA, you may call the Vehicle Safety Hotline toll-free at 1-888-327-4236 (TTY: 1-800-424-9153); go to <http://www.safercar.gov>; or write to: Administrator, NHTSA, 400 Seventh Street, SW., Washington, DC 20590. You can also obtain other in-

formation about motor vehicle safety from <http://www.safercar.gov>.

For Canadian customers

Canadian customers who wish to report a safety-related defect to Transport Canada, Defect Investigations and Recalls, may call the toll-free hotline 1-800-333-0510. You can also obtain other information about motor vehicle safety from <http://www.tc.gc.ca/roadsafety>.

امداد خودرو فاروس

تلفن شبانه روزی: ۰۲۱-۸۸۸۶۲۰۸۵

www.asos.com

امداد خودرو فارما

تلفن شبانه روزی: ۰۲۱-۸۸۸۶۲۰۸۵

FarmaSOS.com



امداد خودرو فارما

تلفن شماره اورژانس: ۰۲۱-۸۸۸۶۲۰۸۵

FarmaSOS.com

At a glance

These overviews of buttons, switches and displays are intended to familiarize you with your vehicle. You will also become quickly acquainted with the available control concepts and options.

امداد خودرو فارما

تلفن شبانه روزی: ۰۲۱-۸۸۸۶۲۰۸۵

FarmaSOS.com

Cockpit

Vehicle features and options

This chapter describes all standard, country-specific and optional features offered with the series. It also describes features that are not necessarily available in your car, e. g., due to

the selected options or country versions. This also applies to safety-related functions and systems. The respectively applicable country provisions must be observed when using the respective features and systems.

All around the steering wheel

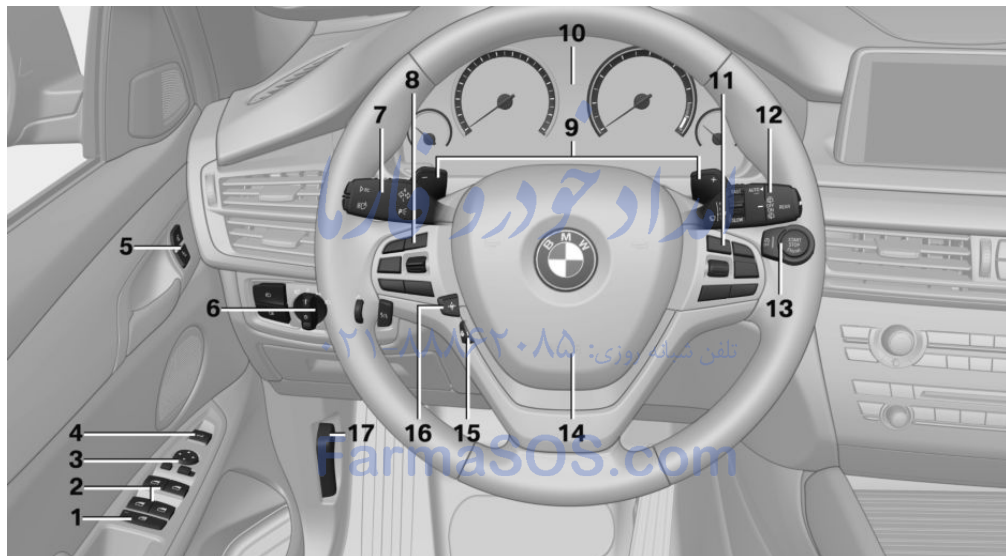

1 Rear window safety switch 49

2 Power windows 48

3 Exterior mirror operation 59

4  Opening and closing the tailgate 40

5  Unlocking central locking system 40

 Locking central locking system 40



























6 Lights

 Front fog lights 104

 Lights off
Daytime running lights 103









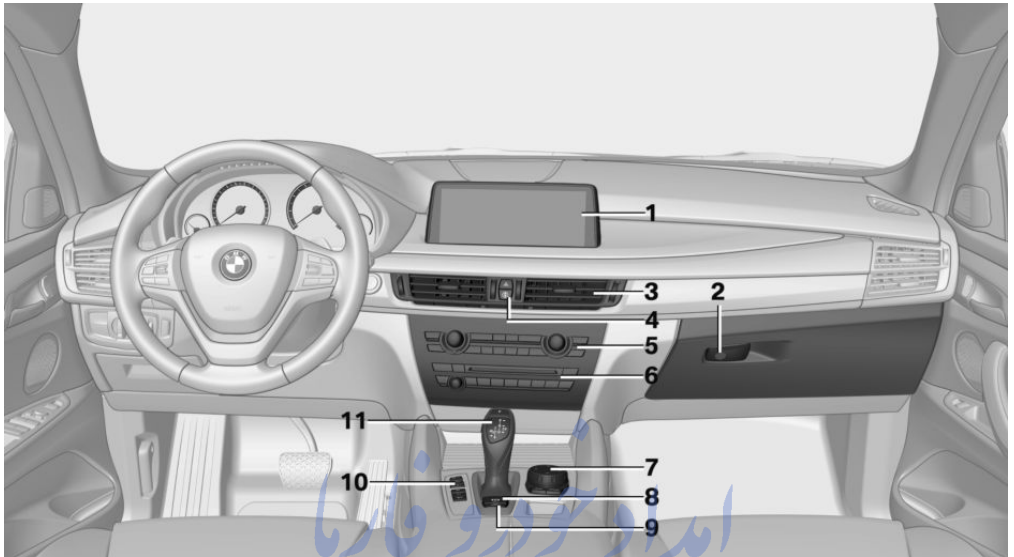

 Parking lights 101

 Low beams 101

-  Automatic headlight control [102](#)
Adaptive Light Control [103](#)
High-beam Assistant [103](#)
-  Instrument lighting [105](#)
-  Night Vision, switch on/switch off heat image [124](#)
- 7** Steering column stalk, left
-  Turn signal [74](#)
-  High beams, headlight flasher [74](#)
-  High-beam Assistant [103](#)
-  Roadside parking lights [102](#)
-  On-board computer [95](#)
- 8** Steering wheel buttons, left
-  Store speed [148](#), [142](#)
-  Resume speed [148](#), [142](#)
-  Cruise control on/off, interrupting [142](#)
-  Cruise control on/off, interrupt [148](#)
-  Cruise control, reduce distance [142](#)
-  Cruise control, increase distance [142](#)
- Cruise control rocker switch [148](#), [142](#)
- 9** Shift paddles [80](#)
- 10** Instrument cluster [82](#)
- 11** Steering wheel buttons, right
-  Entertainment source
-  Volume
-  Voice activation [26](#)
-  Telephone, see user's manual for Navigation, Entertainment and Communication
-  Thumbwheel for selection lists [94](#)
- 12** Steering column stalk, right
-  Wiper [75](#)
-  Rain sensor [76](#)
-  Clean the windshields and headlights [75](#)
- 13**  Start/stop the engine and switch the ignition on/off [68](#)
-  Auto Start/Stop function [69](#)
- 14** Horn, total area
- 15**  Steering wheel heating [61](#)
- 16**  Adjust steering wheel [61](#)
- 17** Unlock hood [220](#)





All around the center console

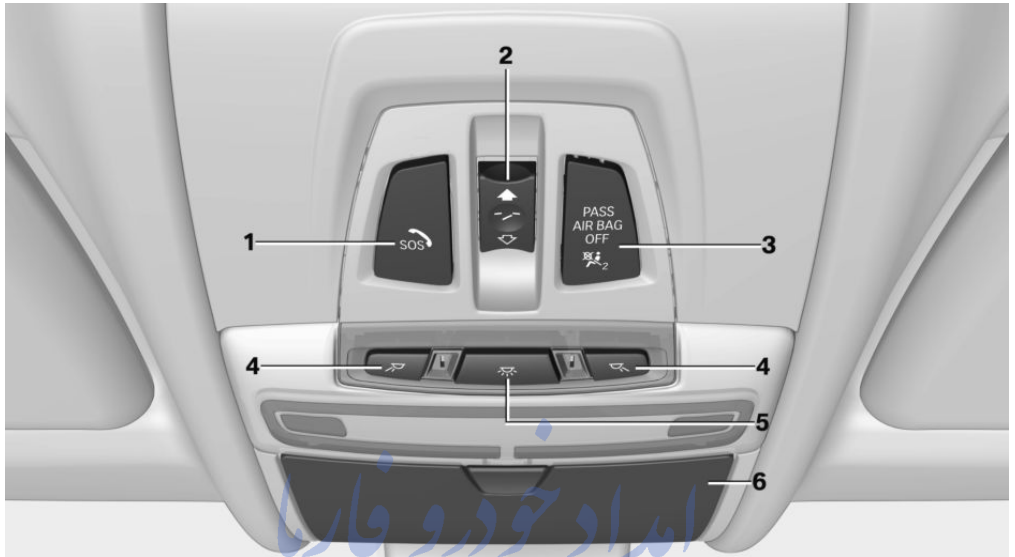

- | | | | | | | |
|---|--|-----|----|---|-------------------|-----|
| 1 | Control Display | 18 | | | | |
| 2 | Glove compartment | 180 | | | | |
| 3 | Ventilation | 167 | | | | |
| 4 |  Hazard warning system | 238 | | | | |
| |  Intelligent Safety button | 115 | | | | |
| 5 | Automatic climate control | 164 | | | | |
| 6 | Radio/CD/Multimedia, see user's manual for Navigation, Entertainment and Communication | | | | | |
| 7 | Controller with buttons | 19 | | | | |
| 8 |  Parking brake | 71 | | | | |
| 9 |  Automatic Hold | 72 | | | | |
| | | | 10 |  DSC Dynamic Stability Control | 135 | |
| | | | |  Driving Dynamics Control | 139 | |
| | | | |  PDC Park Distance Control | 151 | |
| | | | |  Rearview camera | 153 | |
| | | | | | Top View | 156 |
| | | | | | Parking assistant | 160 |
| | | | |  Side View | 158 | |
| | | | |  HDC Hill Descent Control | 137 | |
| | | | 11 | Transmission selector lever | 78 | |

All around the roofliner



- | | | | | | |
|---|---|---|---|---|---|
| 1 |  | Intelligent Emergency Request 238 | 4 |  | Reading lights 105 |
| 2 |  | Glass sunroof, powered 49 | 5 |  | Interior lights 105 |
| 3 |  | Indicator lamp, front-seat passenger airbag 108 | 6 | | Glasses compartment 182 |

iDrive

Vehicle features and options

This chapter describes all standard, country-specific and optional features offered with the series. It also describes features that are not necessarily available in your car, e. g., due to the selected options or country versions. This also applies to safety-related functions and systems. The respectively applicable country provisions must be observed when using the respective features and systems.

The concept

The iDrive combines the functions of many switches. Thus, these functions can be operated from a central location.



WARNING

Operating the integrated information system and communication devices while driving can distract from traffic. It is possible to lose control of the vehicle. There is risk of an accident. Only use the systems or devices when the traffic situation allows. If necessary stop and use the systems and devices while the vehicle is stationary. ◀

Control elements at a glance

Control elements

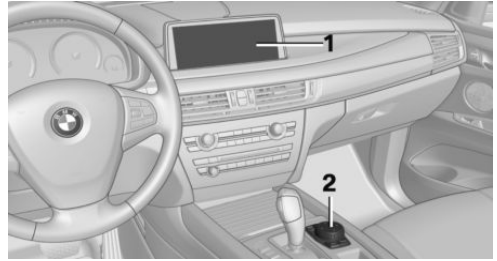

- 1 Control Display
- 2 Controller with buttons and, depending on the equipment version, with touchpad

Control Display

Information

- ▶ To clean the Control Display, follow the care instructions.
- ▶ Do not place objects close to the Control Display; otherwise, the Control Display can be damaged.
- ▶ In the case of very high temperatures on the Control Display, e.g. due to intense solar radiation, the brightness may be reduced down to complete deactivation. Once the temperature is reduced, e.g. through shadow or climate control system, the normal functions are re-established.

Switching on

1. Switch on the ignition.
2. Press the controller.

Switch off

1.  Press button.

2. "Turn off control display"

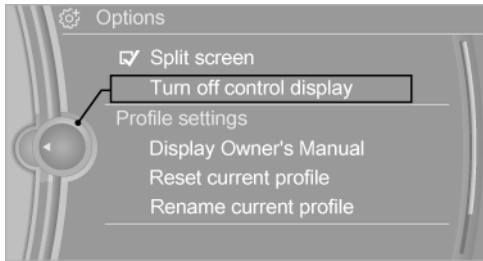

3. Move in four directions.

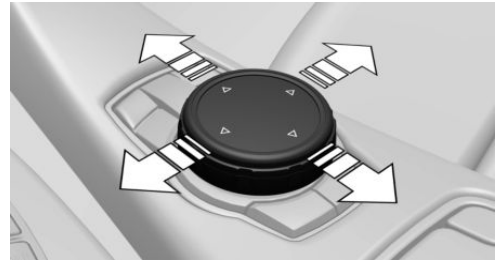

Controller with navigation system

The buttons can be used to open the menus directly. The controller can be used to select menu items and enter the settings.

Some iDrive functions can be operated using the touchpad on the controller.

1. Turn.

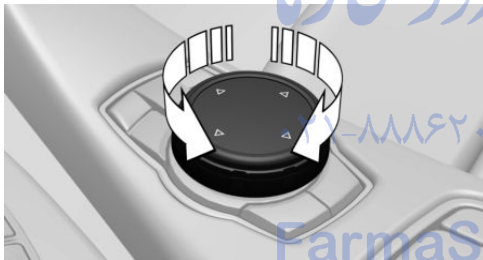

2. Press.



Buttons on controller

Press button	Function
MENU	Open the main menu.
RADIO	Opens the Radio menu.
MEDIA	Opens the Multimedia menu.
NAV	Opens the Navigation menu.
TEL	Opens the phone menu.
BACK	Displays the previous display.
OPTION	Opens the Options menu.

Controller without navigation system

The buttons can be used to open the menus directly. The controller can be used to select menu items and enter the settings.

1. Turn.

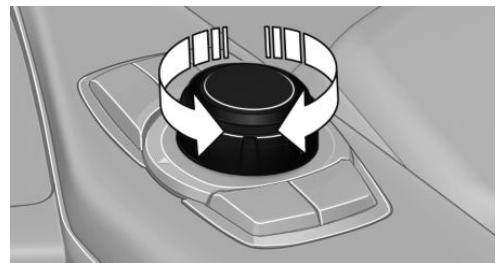

2. Press.

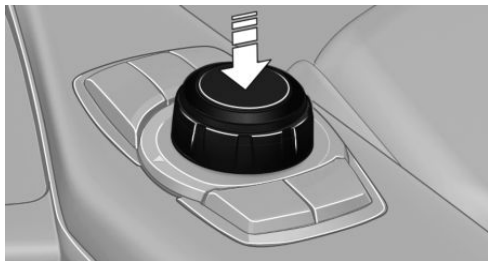

3. Move in two directions.

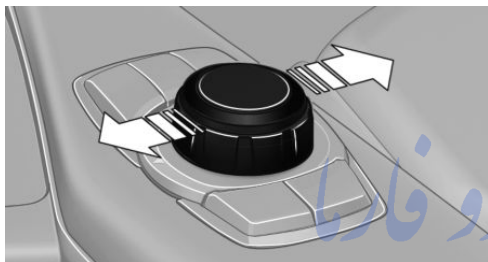

Buttons on controller

Press button	Function
MENU	Open the main menu.
Audio	Open audio menu last listened to, switch between audio menus.
TEL	Opens the phone menu.
BACK	Open previous panel.
OPTION	Opens the Options menu.

Operating concept

Opening the main menu

 Press button.

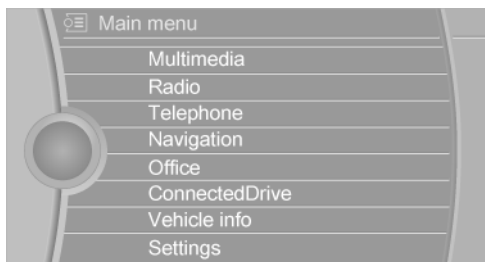

The main menu is displayed.

All iDrive functions can be called up via the main menu.

Selecting menu items

Highlighted menu items can be selected.

1. Turn the controller until the desired menu item is highlighted.

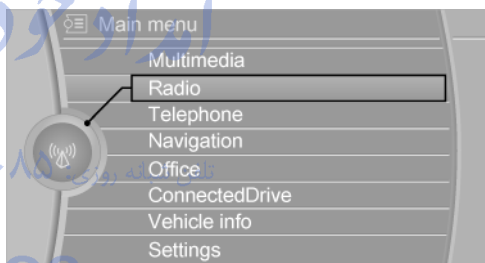

2. Press the controller.

Menu items in the Owner's Manual

In the Owner's Manual, menu items that can be selected are set in quotation marks, e.g., "Settings".

Changing between panels

After a menu item is selected, e.g., "Radio", a new panel is displayed. Panels can overlap.

- ▷ Move the controller to the left.
Closes current display and shows previous display.
Reopens previous display by pressing BACK button. In this case, the current panel is not closed.
- ▷ Move the controller to the right.

Opens new display on top of previous screen.

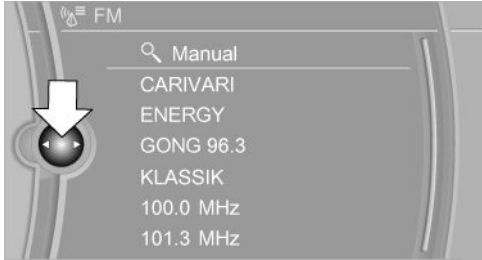

White arrows pointing to the left or right indicate that additional panels can be opened.

Opening the Options menu

 Press button.

The "Options" menu is displayed.

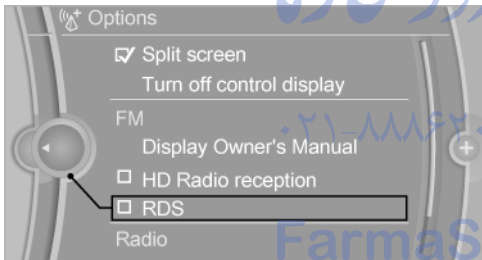

Additional options: move the controller to the right repeatedly until the "Options" menu is displayed.

Options menu

The "Options" menu consists of various areas:

- ▶ Screen settings, e.g., "Split screen".
- ▶ Control options for the selected main menu, e.g., for "Radio".
- ▶ If applicable, further operating options for the selected menu, e.g., "Store station".

Changing settings

1. Select a field.

2. Turn the controller until the desired setting is displayed.

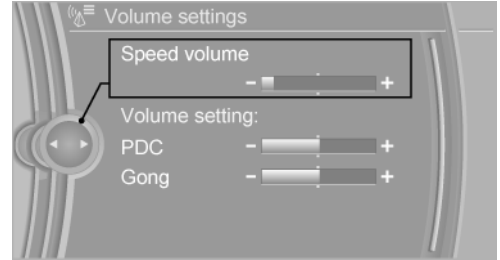

3. Press the controller.

Activating/deactivating the functions

Several menu items are preceded by a check-box. It indicates whether the function is activated or deactivated. Selecting the menu item activates or deactivates the function.

- Function is activated.
- Function is deactivated.

Touchpad

Some iDrive functions can be operated using the touchpad on the controller:

Selecting functions

1. "Settings"
2. "Touchpad"
3. Select the desired function.
 - ▶ "Speller": enter letters and numbers.
 - ▶ "Interactive map": viewing the interactive map.
 - ▶ "Browser": enter Internet addresses.
 - ▶ "Audio feedback": pronounces entered letters and numbers.

Entering letters and numbers

Entering letters requires some practice at the beginning. When entering, pay attention to the following:

- ▶ The system recognizes capital and lower case letters. For the input of upper/lower case letters and numbers, it may be necessary to switch to the corresponding input mode, e.g. when upper and lower case letters are written the same way. Switching between cases, numbers and letters, refer to page 25.
- ▶ Enter characters as they are displayed on the Control Display.
- ▶ Always enter associated characters, such as accents or periods so that the letter can be clearly recognized. Possible input depends on the set language. Where necessary, enter special characters via the controller.
- ▶ To delete a character, slide to the left on the touchpad.
- ▶ To enter a blank space, slide to the right in the center of the touchpad.
- ▶ To enter a hyphen, slide to the right in the upper area of the touchpad.
- ▶ To enter an underscore, swipe to the right in the lower area of the touchpad.

Using interactive map and Internet

Via touch-pad move the interactive map in the navigation system and Internet sites.

Function	Controls
Move interactive map or Internet sites.	Swipe into respective direction.
Enlarge/shrink interactive map or Internet sites.	Drag in or out on the touchpad with fingers.
Display the menu or open a link in the Internet.	Tap once.

Changing settings

You may change control display settings via touchpad. Swipe left or right accordingly.

Example: setting the clock

Setting the clock

On the Control Display:

1.  Press button. The main menu is displayed.
2. Turn the controller until "Settings" is highlighted, and then press the controller.

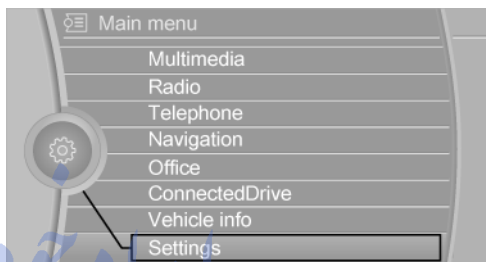

3. If necessary, move the controller to the left to display "Time/Date".
4. Turn the controller until "Time/Date" is highlighted, and then press the controller.



5. Turn the controller until "Time:" is highlighted, and then press the controller.



6. Turn the controller to set the hours and press the controller.
7. Turn the controller to set the minutes and press the controller.

Status information

Status field



The following information is displayed in the status field at the top right:

- ▷ Time.
- ▷ Current entertainment source.
- ▷ Sound output, on/off.
- ▷ Wireless network reception strength.
- ▷ Phone status.
- ▷ Traffic bulletin reception.







Status field symbols





The symbols are grouped as follows.

Radio symbols





Symbol	Meaning
	HD Radio station is being received.
	Satellite radio is switched on.

Telephone symbols

Symbol	Meaning
	Incoming or outgoing call.
	Missed call.
	Wireless network reception strength. Symbol flashes: network search.
	Wireless network is not available.
	Bluetooth is switched on.
	Roaming is active.

Symbol	Meaning
	Text message was received.
	Check the SIM card.
	SIM card is blocked.
	SIM card is missing.
	Enter PIN.

Entertainment symbols

Symbol	Meaning
	CD/DVD player.
	Music collection.
	Gracenote® database.
	AUX-IN port in the front or in the rear.
	USB audio interface.

Additional symbols

Symbol	Meaning
	Spoken instructions are turned off.

Split screen

General information

Additional information can be displayed on the right side of the split screen, e.g., information from the on-board computer.

In the divided screen view, the so-called split screen, this information remains visible even when you change to another menu.

Switching the split screen on and off

On the Control Display:

1.  Press button.

2. "Split screen"

Selecting the display

On the Control Display:

-  Press button.
- "Split screen"
- Move the controller until the split screen is selected.
- Press the controller or select "Split screen content".
- Select the desired menu item.

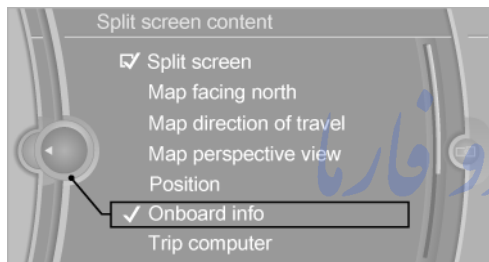

Programmable memory buttons

General information

The iDrive functions can be stored on the programmable memory buttons and called up directly, e.g., radio stations, navigation destinations, phone numbers and menu entries.

Settings are stored for the profile currently used.

Saving a function

- Highlight the function via the iDrive.
-  Press and hold the desired button, until a signal sounds.

Running a function

-  Press button.

The function will work immediately. This means, e.g., that the number is dialed when a phone number is selected.

Displaying the button assignment

Touch buttons with bare fingers. Do not wear gloves or use objects.

The key assignment is displayed at top edge of screen.

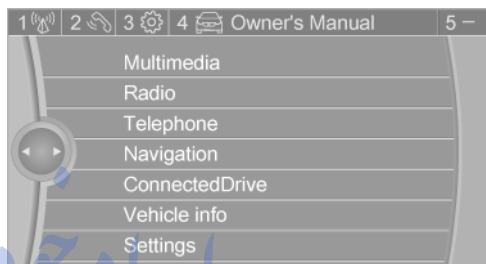

Deleting the button assignments

- Press buttons 1 and 8 simultaneously for approx. five seconds.
- تلفن شماره رو "OK"

Deleting personal in the vehicle

The concept

Depending on the usage, the vehicle saves personal data, such as stored radio stations. These personal data can be permanently deleted through iDrive.

General information

Depending on the equipment package, the following data can be deleted:

- ▷ Personal Profile settings.
- ▷ Stored radio stations.
- ▷ Stored Favorites buttons.
- ▷ Travel and on-board computer information.
- ▷ Music collection.

- ▷ Navigation, e.g. stored destinations.
- ▷ Phone book.
- ▷ Online data, e.g. Favorites, cookies.
- ▷ Voice notes
- ▷ Login accounts.
- ▷ RemoteApp smartphone tethering.

Altogether, the deletion of the data can take up to 30 minutes.

Functional requirement

Data can only be deleted while stationary.

Deleting data

Heed and follow the instructions on the Control Display.

1. Switch on the ignition.
2. "Settings"
3. Open "Options".
4. "Delete personal data"
5. "Continue"
6. "OK"

Entering letters and numbers

General information

On the Control Display:

1. Turn the controller: select letters or numbers.
2. Select additional letters or numbers if needed.
3. "OK": confirm the entry.

Symbol	Function
⬅	Press the controller: delete the letter or number.
⬅	Press the controller for an extended period: delete all letters or numbers.

Switching between cases, letters and numbers

Depending on the menu, you can switch between entering upper and lower case, letters and numbers:

Symbol	Function
A ^B C	Enter the letters.
1@+	Enter the numbers.
abc or ABC	Tip controller up.

Without navigation system

@^A A^a a[@] Select symbol.

Entry comparison

Entering names and addresses: choice is narrowed down with every letter entered and letters may be added automatically.

Entries are continuously compared with data stored in the vehicle.

- ▷ Only those letters are offered during input for which data is available.
- ▷ Target search: names of locations may be entered in languages available through Control Display.

Voice activation system

Vehicle features and options

This chapter describes all standard, country-specific and optional features offered with the series. It also describes features that are not necessarily available in your car, e. g., due to the selected options or country versions. This also applies to safety-related functions and systems. The respectively applicable country provisions must be observed when using the respective features and systems.

The concept

- ▷ Most functions displayed on the Control Display can be operated by voice commands via the voice activation system. The system supports you with announcements during input.
- ▷ Functions that can only be used when the vehicle is stationary cannot be used via the voice activation system.
- ▷ The system uses a special microphone on the driver's side.
- ▷ ›...‹ Verbal instructions in the Owner's Manual to use with the voice activation system.

Requirements

Via the Control Display, set a language that is also supported by the voice activation system so that the spoken commands can be identified.

Set the language, refer to page 98.

Using voice activation

Activating the voice activation system

1.  Press button on the steering wheel.
2. Wait for the signal.
3. Say the command.

A command that is recognized by the voice activation system is announced and displayed in the instrument cluster.

 This symbol in the instrument cluster indicates that the voice activation system is active.

If no other commands are available, use function via iDrive.

Terminating the voice activation system

 Briefly press the button on the steering wheel or ›Cancel‹.

Possible commands

Most menu items on the Control Display can be voiced as commands.

The available commands depend on the menu that is currently displayed on the Control Display.

There are short commands for many functions.

You may select lists such as phone lists via voice activation. Read these lists out loud exactly as they show in the respective list.

Having possible commands read aloud

You can have available commands read out loud for you: ›Voice commands‹.

E. g. if the "Settings" menu is displayed, the commands for the settings are read out loud.

Executing functions using short commands

Execute functions on the main menu via short commands. It almost doesn't matter which menu item is selected, e.g., ›Vehicle status‹.

List of short commands for the voice activation system, see Navigation, Entertainment, Communication Owner's Manual.

Help dialog for the voice activation system

Calling up help dialog: ›Help‹.

Additional commands for the help dialog:

- ▶ ›Help with examples‹: announces information about the current operating options and the most important commands for them.
- ▶ ›Help with voice activation‹: information about the principle of operation for the voice activation system is announced.

One example: open the tone settings

Via the main menu

The commands of the menu items are spoken just as they are selected via the controller.

1. Turn on the Entertainment sound output if needed.
2.  Press button on the steering wheel.
3. ›Radio‹
4. ›Tone‹

Via short command

The desired tone settings can also be started via a short command.

1. Turn on the Entertainment sound output if needed.

2.  Press button on the steering wheel.
3. ›Tone‹

Setting the voice dialog

Set system to standard dialog or use a short version.

The short version of the voice dialog plays back short messages in abbreviated form.

1. "Settings"
2. "Language/Units"
3. "Speech type:"
4. Select setting.



Adjusting the volume

Turn the volume button during the spoken instructions until the desired volume is set.

- ▶ The volume remains constant even if the volume of other audio sources is changed.
- ▶ The volume is stored for the profile currently used.

Information on Emergency Requests

Do not use the voice activation system to initiate an Emergency Request. In stressful situations, the voice and vocal pitch can change.

This can unnecessarily delay the establishment of a phone connection.

Instead, use the SOS button, refer to page 238, close to the interior mirror.

Environmental conditions

- ▷ Say the commands, numbers, and letters smoothly and with normal volume, emphasis, and speed.
- ▷ Always say commands in the language of the voice activation system.
- ▷ Keep the doors, windows, and glass sunroof closed to prevent noise interference.
- ▷ Avoid making other noise in the vehicle while speaking.

امداد خودرو فارما

تلفن شبانه روزی: ۰۲۱-۸۸۸۶۲۰۸۵

FarmaSOS.com

Integrated Owner's Manual in the vehicle

Vehicle features and options

This chapter describes all standard, country-specific and optional features offered with the series. It also describes features that are not necessarily available in your car, e. g., due to the selected options or country versions. This also applies to safety-related functions and systems. The respectively applicable country provisions must be observed when using the respective features and systems.

Integrated Owner's Manual in the vehicle

The Integrated Owner's Manual can be displayed on the Control Display. It specifically describes features and functions found in the vehicle.

Components of the Integrated Owner's Manual

The Integrated Owner's Manual consists of three parts, which offer various levels of information or possible access.

Quick Reference Guide

The Quick Reference Guide provides information how to operate the car, how to use basic vehicle functions or what to do in case of a breakdown. This information can also be displayed while driving.

Search by images

Image search provides information and descriptions. This is helpful when the terminology for a feature is not at hand.

Owner's Manual

Search for information and descriptions by entering terms selected from the index.

Select components

1.  Press button.
2. Turn the controller: open "Vehicle info".
3. Press the controller.
4. Selecting desired range:
 - ▷ "Quick reference"
 - ▷ "Search by pictures"
 - ▷ "Owner's Manual"

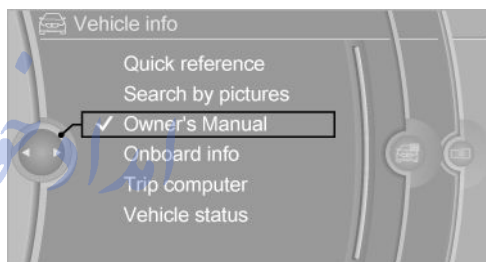

Leafing through the Owner's Manual

Page by page with link access

Turn the controller until the next or previous page is displayed.

Page by page without link access

Scroll through the pages directly while skipping the links.

Highlight the symbol once. Now simply press the controller to browse from page to page.



Scroll back.



Scroll forward.

Context help - Owner's Manual to the temporarily selected function

You may open the relevant information directly.

Opening via the iDrive

To move directly from the application on the Control Display to the Options menu:

1.  Press button or move the controller to the right repeatedly until the "Options" menu is displayed.
2. "Display Owner's Manual"



Opening when a Check Control message is displayed

Directly from the Check Control message on the Control Display:

"Display Owner's Manual"

Changing between a function and the Owner's Manual

To switch from a function, e. g., radio, to the Owner's Manual on the Control Display and to alternate between the two displays:

1.  Press button or move the controller to the right repeatedly until the "Options" menu is displayed.
2. "Display Owner's Manual"
3. Select the desired page in the Owner's Manual.
4.  Press button again to return to last displayed function.
5.  Press button to return to the page of the Owner's Manual displayed last.

To alternate permanently between the last displayed function and the Owner's Manual repeat steps 4 & 5. Opens a new display every time.

Programmable memory buttons

General information

The Owner's Manual can be stored on the Programmable memory buttons and called up directly.

Storing

1. "Owner's Manual" Select via the iDrive.
2.  Press selected button for more than 2 seconds.

Executing

1.  Press button. The Owner's Manual is displayed immediately.

امداد خودرو فارما

تلفن شبانه روزی: ۰۸۵ ۱۱۱۶۲۰۲۱

FarmaSOS.com

امداد خودرو فارما

تلفن شبانه روزی: ۰۲۱-۸۸۸۶۲۰۸۵

FarmaSOS.com



START
STOP
ENGINE

امداد خودرو فارما

تلفن شبانه روزی: ۰۲۱-۸۸۸۶۲۰۸۵

FarmaSOS.com

Controls

This chapter is intended to provide you with information that will give you complete control of your vehicle. All features and accessories that are useful for driving and your safety, comfort and convenience are described here.

تلفن شبانه روزی: ۰۲۱-۸۸۸۶۲۰۸۵

FarmaSOS.com

Opening and closing

Vehicle features and options

This chapter describes all standard, country-specific and optional features offered with the series. It also describes features that are not necessarily available in your car, e. g., due to the selected options or country versions. This also applies to safety-related functions and systems. The respectively applicable country provisions must be observed when using the respective features and systems.

Remote control/key

General information

The vehicle is supplied with two remote controls with integrated key.

Every remote control holds a replaceable battery.

You may set the key functions depending on the optional features and country-specific version. For Settings, refer to page 45.

The vehicle stores personal settings for every remote control. Personal Profile, refer to page 35.

The remote controls hold information on required maintenance. Service data in the remote control, refer to page 228

Overview

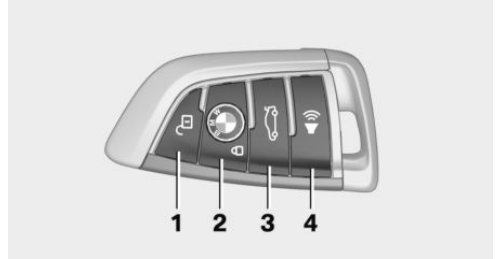

- 1 Unlocking
- 2 Locking
- 3 Opening the tailgate
- 4 Panic mode

Integrated key

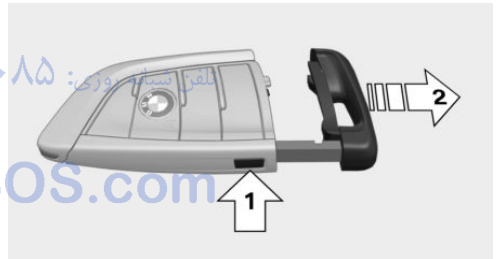

Press button, arrow 1, and remove the key, arrow 2.

The integrated key fits the following locks:

- ▷ Driver's door.
- ▷ Glove compartment on the front passenger side.

Replacing the battery

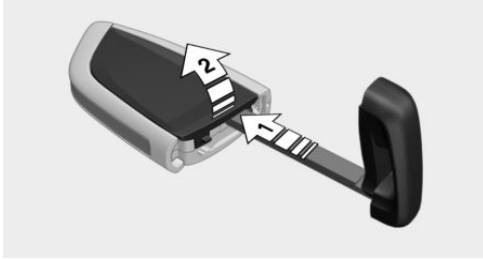

1. Remove integrated key from remote control.
2. Raise the cover of the battery compartment, arrow 1.
3. Remove the cover of the battery compartment, arrow 2.
4. Insert a battery of the same type with the positive side facing up.
5. Press the cover closed.



Have old battery disposed of by a dealer's service center or another qualified service center or repair shop or take it to a collection point.

New remote controls

New remote controls are available from a dealer's service center or another qualified service center or repair shop.

Loss of the remote controls

The lost remote control can be blocked by a dealer's service center or another qualified service center or repair shop.

Emergency detection of remote control

It is possible to switch on the ignition or start the engine in situations such as the following:

- ▶ Interference of radio transmission to remote control by external sources e.g., by radio masts.
- ▶ Empty battery in remote control.

- ▶ Interference from radio transmissions through mobile devices in close proximity to remote control.
- ▶ Interference of radio transmission by charger while charging items such as mobile devices in the vehicle.

A Check Control message is displayed if an attempt is made to switch on the ignition or start the engine.

Starting the engine with emergency detection of the remote control

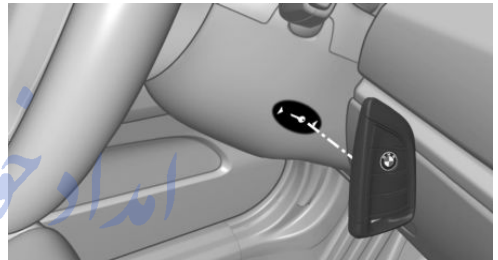

If a respective Check Control message appears, hold the remote control with its back against the marked area on the steering column. The tailgate button on the remote control should be at the same height as the marked area. Press the Start/Stop button within 10 seconds while pressing the brake pedal. If the remote control is not recognized: slightly change the height position of the remote control and repeat the procedure.

Personal Profile

The concept

Personal Profile provides three profiles, using which personal vehicle settings can be stored. Every remote control has one of these profiles assigned.

If the vehicle is unlocked using a remote control, the assigned personal profile will be activated. All settings stored in the profile are automatically applied.

If several drivers use their own remote control, the vehicle will adjust the personal settings during unlocking. These settings are also re-stored, if the vehicle has been used in the meantime by a person with a different remote control.

Changes to the settings are automatically saved in the personal profile.

Three personal profiles and a guest profile can be created.

Adjusting

The settings for the following systems and functions are saved in the active profile. The scope of storable settings is country- and equipment-dependable.

- ▷ Unlocking and locking.
- ▷ Lights.
- ▷ Climate control.
- ▷ Radio.
- ▷ Instrument cluster.
- ▷ Programmable memory buttons.
- ▷ Volumes, tone.
- ▷ Control Display.
- ▷ Navigation.
- ▷ Park Distance Control PDC.
- ▷ Rearview camera
- ▷ Side View.
- ▷ Head-up Display.
- ▷ Driving Dynamics Control.
- ▷ Driver's seat position, exterior mirror position, steering wheel position.
- ▷ Cruise control.
- ▷ Intelligent Safety.
- ▷ Active Blind Spot Detection.
- ▷ Night vision.

Profile management

Opening profiles

Regardless of the remote control in use a different profile may be activated.

About iDrive:

1. "Settings"
2. "Profiles"
3. Select a profile.
 - ▷ All settings stored in the called-up profile are automatically applied.
 - ▷ The called-up profile is assigned to the remote control being used at the time.
 - ▷ If the profile is already assigned to a different remote control, this profile will apply to both remote controls. It cannot be differentiated anymore between the settings for the two remote controls.

Renaming profiles

A personal name can be assigned to every profile to avoid confusion between the profiles.

On the Control Display:

1. "Settings"
2. "Profiles"
3. Open "Options".
4. "Rename current profile"

Resetting profiles

The settings of the active profile are reset to their default values.

On the Control Display:

1. "Settings"
2. "Profiles"
3. Open "Options".
4. "Reset current profile"

Exporting profiles

Most settings of the active profile can be exported.

This can be helpful for securing and retrieving personal settings, before delivering the vehicle to a workshop, e.g. Profiles can be taken to another vehicle equipped with the Personal Profile function.

The following export options are available:

- ▷ Via BMW Online.
- ▷ Via the USB port to a USB device.

Popular file systems for USB devices are supported. FAT32 and exFAT are the recommended formats for profile export.

Other formats may not support the export.

Export is made via the USB port to a USB device. Popular file systems for USB devices are supported. FAT32 and exFAT are the recommended formats for profile export. Other formats may not support the export.

On the Control Display:

1. "Settings"
2. "Profiles"
3. "Export profile"
4. BMW Online: "BMW Online" – ۸۸۸۶۲۰۸۵
USB interface: "USB device"

Importing profiles

Profiles exported via BMW Online can also be imported via BMW Online.

Profiles stored on a USB device can be imported via the USB interface.

Existing settings are overwritten with the imported profile.

On the Control Display:

1. "Settings"
2. "Profiles"
3. "Import profile"
4. BMW Online: "BMW Online"
USB interface: "USB device"

Using the guest profile

The guest profile is for individual settings that are saved in none of the three personal profiles.

This can be useful for drivers who are using the vehicle temporarily and do not have their own profile.

On the Control Display:

1. "Settings"
2. "Profiles"
3. "Guest"

The guest profile cannot be renamed. It is not assigned to the current remote control.

Display profile list during start

The profile list can be displayed during each start to select the desired profile.

On the Control Display:

1. "Settings"
2. "Profiles"
3. Open "Options".
4. "Display user list at startup"

Using the remote control

Information



WARNING

People or animals in the vehicle can lock the doors from the inside and lock themselves in. The vehicle can then not be opened from the outside. There is risk of injuries. Take the remote control along so that the vehicle can be opened from the outside. ◀

Unlocking



Press button on the remote control.

Depending on the settings, refer to page 45, the following access points are unlocked.

- ▷ Driver's door and fuel filler flap.
- ▷ All doors, tailgate, and fuel filler flap.

In addition, the following functions are executed:

- ▷ The interior lights are switched on, when it is dark outside, the courtesy lamps are also switched on. This function is not available, if the interior lamps were switched off manually.
- ▷ The welcome lamps are switched on, if this function was activated.
- ▷ The alarm system, refer to page 46, is disarmed.

Convenient opening



Press and hold this button on the remote control after unlocking.

The windows and the glass sunroof are opened, as long as the button on the remote control is pressed.

Locking



WARNING

Unlocking from the inside is only possible with special knowledge.

If people must spend a longer time in the vehicle while it is very hot or cold outside, there is risk of injuries or danger to life. Do not lock the vehicle from the outside when there are people in it. ◀

The driver's door must be closed.



Press button on the remote control.

All doors, the tailgate, and the fuel filler flap are being locked.

The alarm system, refer to page 46, is armed.

Switching on interior lights and courtesy lights



Press button on the remote control with the vehicle locked.

The courtesy lamps are only switched on when it is dark outside. This function is not available, if the interior lamps were switched off manually.

If the button is pressed again within 10 seconds after vehicle was locked, the interior motion sensor and tilt alarm sensor of the anti-theft warning system, refer to page 47, are turned off. After locking, wait 10 seconds before pressing the button again.

Panic mode

You can trigger the alarm system if you find yourself in a dangerous situation.



Press button on the remote control for at least 3 seconds.

To switch off the alarm: press any button.

Opening the tailgate



CAUTION

The tailgate swings back and up when it opens. There is risk of property damage. Make sure that the area of movement of the tailgate is clear during opening and closing. ◀

To avoid locking it into the vehicle, do not place the remote control in the cargo area.



Press button on the remote control for approx. 1 second.

The closed tailgate is automatically opened, whether or not the vehicle is locked or unlocked.

Depending on the features and the country version, it is also possible to have door unlocked. Create the settings, refer to page 45.

The tailgate cannot be opened with the remote control while a trailer is being towed.

If the doors were not unlocked, the tailgate is locked again as soon as it closes. Take the remote control with you and do not leave it in the cargo area; otherwise, the remote control is locked inside the vehicle when the tailgate is closed.



CAUTION

Sharp-edged or pointed objects can hit the rear window and heat conductors while driving. There is risk of property damage. Cover the edges and ensure that pointed objects do not hit the rear window. ◀

Malfunction

Remote control detection by the vehicle can among others be malfunctioning under the following circumstances:

- ▶ The battery of the remote control is discharged. Replace the battery, refer to page 35.
- ▶ Interference of the radio connection from transmission towers or other equipment with high transmit power.
- ▶ Shielding of the remote control due to metal objects.
- ▶ Interference of the radio connection from mobile phones or other electronic devices in direct proximity.

Do not transport the remote control together with metal objects or electronic devices.

In the case of interference, the vehicle can also be unlocked and locked from the outside without remote control, refer to page 39.

For US owners only

The transmitter and receiver units comply with part 15 of the FCC/Federal Communication Commission regulations. Operation is governed by the following:

FCC ID:

- ▶ LX8766S.
- ▶ LX8766E.

- ▶ LX8CAS.
- ▶ LX8CAS2.
- ▶ MYTCAS4.

Compliance statement:

This device complies with part 15 of the FCC Rules. Operation is subject to the following two conditions:

- ▶ This device may not cause harmful interference, and
- ▶ this device must accept any interference received, including interference that may cause undesired operation.

Any unauthorized modifications or changes to these devices could void the user's authority to operate this equipment.

Without remote control

From the outside



WARNING

Unlocking from the inside is only possible with special knowledge.

If people must spend a longer time in the vehicle while it is very hot or cold outside, there is risk of injuries or danger to life. Do not lock the vehicle from the outside when there are people in it. ◀



CAUTION

The door lock is permanently joined with the door. The door handle can be moved. When pulling the door handle with the integrated key inserted, paint or key can be damaged. There is risk of property damage. Remove the integrated key before pulling the outside door handle. ◀

Unlock or lock the driver's door via the door lock using the integrated key, refer to page 34. The other doors must be unlocked or locked from the inside.

1. Remove lid on the door lock.

To do this, slide the integrated key into the opening from below and remove the lid.

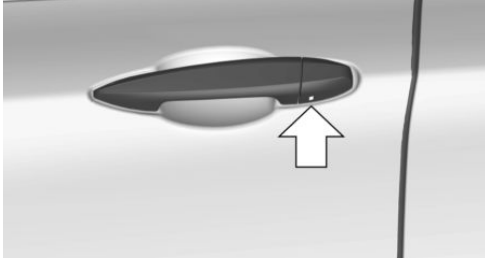

2. Unlock or lock door lock.

Alarm system

The alarm system is not armed if the vehicle is locked with the integrated key.

The alarm system is triggered when the door is opened, if the vehicle was unlocked via the door lock.



In order to terminate this alarm, unlock vehicle with the remote control or switch on the ignition, if needed, through emergency detection of the remote control, refer to page 35.

From the inside

Unlocking and locking



Via the buttons for the central locking system.

- ▷  By pressing the button, the vehicle is locked with the doors closed.
- ▷  Pressing the button unlocks the vehicle.

The vehicle is not secured against theft when locking.

The fuel filler flap remains unlocked.

In the event of a severe accident, the vehicle is automatically unlocked. The hazard warning system and interior lights come on.

Unlocking and opening

- ▷  Press the central locking system button to unlock the doors together, and then pull the door handle above the armrest.
- ▷ Front doors: pull the door handle on the door to open the door. The other doors remain locked.
- ▷ Back doors: pull twice on the door handle on the door to be opened; the first time unlocks the door, the second time opens it. The other doors remain locked.

Doors

Automatic Soft Closing

To close the doors, push lightly.

It is closed automatically.



WARNING

Thanks to Soft Close the closing goes into the lock automatically. Body parts can be jammed. There is risk of injuries. Make sure that the area of movement of the doors is clear during opening and closing. ◀

Tailgate

Information

To avoid locking it into the vehicle, do not place the remote control in the cargo area.

Automatic tailgate operation

Adjusting the opening height

You can set how far the tailgate should open.

CAUTION

The tailgate swings back and up when it opens. There is risk of property damage. Make sure that the area of movement of the tailgate is clear during opening and closing. ◀

When adjusting the opening height, ensure that there is a clearance of at least 4 in/10 cm above the tailgate.

1. "Settings"
2. "Tailgate"
3. Turn the controller until the desired opening height is selected.

Opening

CAUTION

The tailgate swings back and up when it opens. There is risk of property damage. Make sure that the area of movement of the tailgate is clear during opening and closing. ◀



- ▷ Press button on tailgate's exterior.
- ▷  Press button on the remote control for approx. 1 second.

As the case may be, the doors are also unlocked. Opening with the remote control, refer to page 38.

The tailgate cannot be opened with the remote control while a trailer is being towed.

- ▷  Press button in the driver's door.
The tailgate cannot be opened with the remote control while the driver's door is opened.

If the vehicle is stationary, the tailgate opens automatically to the adjusted opening height. The opening procedure is interrupted:

- ▷ By pressing a button again.
- ▷ When starting the engine.
- ▷ When the vehicle starts moving.
- ▷ By pressing the button on the inside of the tailgate.

Closing

WARNING

Body parts can be jammed when operating the tailgate. There is risk of injuries. Make sure that the area of movement of the tailgate is clear during opening and closing. ◀

CAUTION

Sharp-edged or pointed objects can hit the rear window and heat conductors while driving. There is risk of property damage. Cover the edges and ensure that pointed objects do not hit the rear window. ◀

The floor panel in the trunk must be closed, otherwise the tailgate cannot be closed.

Without Comfort Access:



- ▷ Press button on the inside of the tailgate.

With Comfort Access:

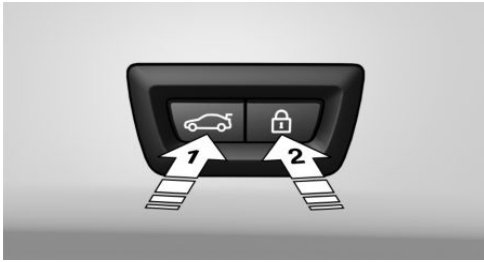

- ▷ Press button, arrow 1, on the inside of the tailgate.

Pressing the button again stops the motion.

- ▷ Press button, arrow 2.

The vehicle will be locked after closing the tailgate. The driver's door must be closed for this purpose and the remote control must be outside of the vehicle in the area of the tailgate.

To avoid locking it into the vehicle, do not place the remote control in the cargo area.

Pressing the button again stops the motion.



- ▷ Press button on tailgate's exterior. Pressing the button again stops the motion.

- ▷  Pull and hold the button in the driver door. Releasing the button stops window/roof movement.

The remote control must be located in the interior for this function.

An acoustic signal sounds and the tailgate closes.

The closing operation is interrupted:

- ▷ When starting the engine.
- ▷ The vehicle starts off with jerks.

Manual operation

WARNING

With manual operation of a blocked tailgate, it can loosen itself unexpectedly from the blockage. There is risk of injuries or risk of property damage. Do not operate the tailgate manually if it is blocked. Have checked by a dealer's service center or another qualified service center or repair shop. ◀

In the event of an electrical malfunction, operate the unlocked tailgate manually with a slow and smooth motion.

Comfort Access

The concept

The vehicle can be accessed without activating the remote control.

All you need to do is to have the remote control with you, such as in your pants pocket.

The vehicle automatically detects the remote control when it is in close proximity or in the car's interior.

Comfort Access supports the following functions:

- ▷ Unlocking/locking of the vehicle.
- ▷ Convenient closing.
- ▷ Opening the tailgate individually
- ▷ Open/close tailgate with no-touch activation.
- ▷ Start the engine.

Information

To avoid locking it into the vehicle, do not place the remote control in the cargo area.

Functional requirements

- ▶ There are no external sources of interference nearby.
- ▶ To lock the vehicle, the remote control must be located outside of the vehicle near the doors.
- ▶ The next unlocking and locking cycle is not possible until after approx. 2 seconds.
- ▶ The engine can only be started if the remote control is in the vehicle.

Unlocking

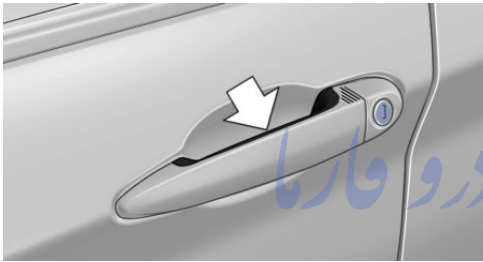

Grasp the handle of a vehicle door completely, arrow.

This corresponds with pressing the button on the remote control. .

Locking

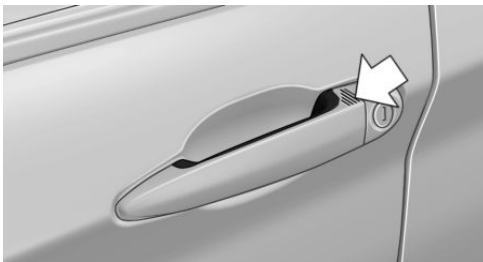

Touch the surface on the handle of a vehicle door, arrow, with your finger for approx. 1 second without grasping the door handle.

This corresponds with pressing the button on the remote control. .

To save battery power, ensure that the ignition and all electronic systems and/or power consumers are turned off before locking the vehicle.

Convenient closing



WARNING

With convenient closing, body parts can be jammed. There is risk of injuries. Make sure that the area of movement of the doors is clear during convenient closing. ◀

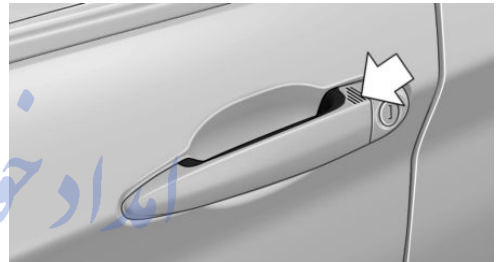

Touch the surface on the handle of a vehicle door, arrow, with your finger and hold it there without grasping the door handle.

This corresponds to pressing and holding  the remote control button.

In addition to locking, the windows and the glass sunroof close and the exterior mirrors fold in.

Unlocking the tailgate separately

Press button on tailgate's exterior.

This corresponds with pressing the button on the remote control. .

The situation of the doors does not change.

Take the remote control with you and do not leave it in the trunk; otherwise, the remote control is locked inside the vehicle when the tailgate is closed.

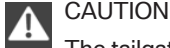
**CAUTION**

The tailgate swings back and up when it opens. There is risk of property damage. Make sure that the area of movement of the tailgate is clear during opening and closing. ◀

Opening and closing the tailgate with no-touch activation

General information

The tailgate can be opened and closed with no-touch activation using the remote control you are carrying. Two sensors detect a forward-directed foot motion in the center of the area at the rear of the car and the trunk lid opens and/or closes.

Foot movement to be carried out

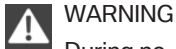
**WARNING**

During no-contact activation, vehicle parts may be touched, e.g. hot exhaust system. There is risk of injuries. With the foot motion, make sure there is steady stance and do not touch the vehicle. ◀

1. Place in the center behind the vehicle, about an arm's length from the vehicle rear.
2. Move a foot in the direction of travel as far under the vehicle as possible and immediately pull it back. With this movement, the leg must pass through the ranges of both sensors.

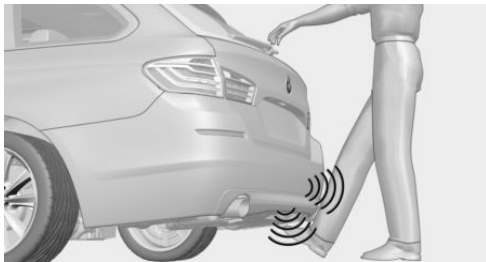

Opening

Perform the foot movement described earlier.

The tailgate opens, regardless of whether it was previously locked or unlocked.

Before the opening, the hazard warning system flashes.

If the remote control is in the sensor area, the tailgate can be closed inadvertently by an unconscious or alleged recognized foot movement.

The sensor range reaches approx. 5 ft/1.50 m behind the area at the rear of the car.

**WARNING**

Body parts can be jammed when operating the tailgate. There is risk of injuries. Make sure that the area of movement of the tailgate is clear during opening and closing. ◀

**CAUTION**

The tailgate swings back and up when it opens. There is risk of property damage. Make sure that the area of movement of the tailgate is clear during opening and closing. ◀

Closing تلفن شماره ۰۲۰۰۰۰۰۰۰۰

Perform the foot movement described earlier.

The hazard warning system flashes on and an acoustic signal sounds before the tailgate closes.

The closing of the tailgate has no effect on the locking of the vehicle.

To avoid locking it into the vehicle, do not place the remote control in the cargo area.

Another foot movement can interrupt the closing operation.

If the remote control is in the sensor area, the tailgate can be closed inadvertently by an unconscious or alleged recognized foot movement.

The sensor range reaches approx. 5 ft/1.50 m behind the area at the rear of the car.

**WARNING**

Body parts can be jammed when operating the tailgate. There is risk of injuries. Make sure that the area of movement of the tailgate is clear during opening and closing. ◀

**CAUTION**

The tailgate swings back and up when it opens. There is risk of property damage. Make sure that the area of movement of the tailgate is clear during opening and closing. ◀

Malfunction

Remote control detection by the vehicle can among others be malfunctioning under the following circumstances:

- ▶ The battery of the remote control is discharged. Replace the battery, refer to page 35.
- ▶ Interference of the radio connection from transmission towers or other equipment with high transmit power.
- ▶ Shielding of the remote control due to metal objects.
- ▶ Interference of the radio connection from mobile phones or other electronic devices in direct proximity.

Do not transport the remote control together with metal objects or electronic devices.

In the case of a malfunction, unlock and lock the vehicle using the buttons of the remote control or using the integrated key, refer to page 39.

Adjusting**Unlocking**

The settings are saved in the active profile, refer to page 35.

Doors

1. "Settings"
2. "Doors/key"
3.  Select the symbol.
4. Select the desired function:
 - ▶ "Driver's door only"

Only the driver's door and the fuel filler flap are unlocked. Pressing again unlocks the entire vehicle.
 - ▶ "All doors"

The entire vehicle is unlocked.

Tailgate

Depending on optional features and country version, this setting is not offered in some cases.

1. "Settings"
2. "Doors/key"
3.  Select the symbol.
4. Select the desired function:
 - ▶ "Tailgate"

The tailgate is opened.
 - ▶ "Tailgate + door(s)"

The tailgate is opened and the doors unlocked.

Confirmation signals from the vehicle

The settings are saved in the active profile, refer to page 35.

1. "Settings"
2. "Doors/key"
3. Deactivate or activate the desired confirmation signals.
 - ▶ "Acoustic sig. lock/unlock"
 - ▶ "Flash when lock/unlock"

Automatic locking

The settings are saved in the active profile, refer to page 35.

1. "Settings"
2. "Doors/key"
3. Select the desired function:
 - ▷ "Lock if no door is opened"

The vehicle locks automatically after a short period of time if no door is opened.
 - ▷ "Lock after start driving"

The vehicle locks automatically after you drive off.

Retrieving the seat, mirror, and steering wheel settings

The driver's seat, exterior mirror, and steering wheel position adjusted last will be stored for the active profile.

When the vehicle is unlocked, these positions are automatically retrieved if this function was activated.

WARNING

There is risk of jamming when moving the seats. There is risk of injuries or risk of property damage. Make sure that the area of movement of the seat is clear prior to any adjustment. ◀

The adjustment procedure is interrupted:

- ▷ When a seat position switch is pressed.
- ▷ When a button of the seat, mirror, and steering wheel memory is pressed briefly.

Activating the setting

1. "Settings"
2. "Doors/key"
3. "Last seat position autom."

Alarm system

The concept

When the vehicle is locked, the vehicle alarm system responds to:

- ▷ Opening a door, the hood or the tailgate.
 - ▷ Movements in the interior.
 - ▷ Changes in the vehicle tilt, e. g., during attempts at stealing a wheel or when towing the car.
 - ▷ Disconnected battery voltage.
- The alarm system briefly signals tampering:
- ▷ By sounding an acoustic alarm.
 - ▷ By switching on the hazard warning system.
 - ▷ By flashing the daytime running lights.

Arming and disarming the alarm system

When you unlock or lock the vehicle, either with the remote control or via the Comfort Access, the alarm system is disarmed or armed at the same time.

Door lock and armed alarm system

The alarm system is triggered when the door is opened, when the vehicle is unlocked via the door lock.

Tailgate and armed alarm system

The tailgate can be opened even when the alarm system is armed.

After the tailgate is closed, it is locked and monitored again when the doors are locked. The hazard warning system flashes once.

Panic mode

You can trigger the alarm system if you find yourself in a dangerous situation.



Press button on the remote control for at least 3 seconds.

To switch off the alarm: press any button.

Indicator lamp on the interior rearview mirror

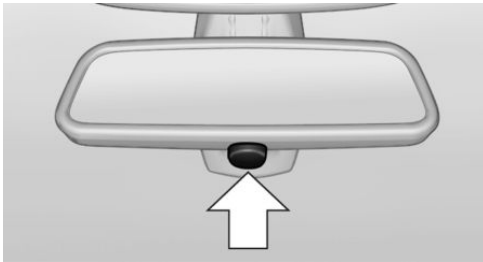

- ▶ The indicator lamp flashes briefly every 2 seconds:
The alarm system is armed.
- ▶ The indicator lamp flashes after locking:
Doors, hood or tailgate are not correctly closed. Correctly closed access points are secured.
After 10 seconds, the indicator lamp flashes continuously. Interior motion sensor and tilt alarm sensor are not active.
When the still open access is closed, interior motion sensor and tilt alarm sensor will be switched on.
- ▶ The indicator lamp goes out after unlocking:
The vehicle has not been tampered with.
- ▶ The indicator lamp flashes after unlocking until the engine ignition is switched on, but no longer than approx. 5 minutes:
An alarm has been triggered.

Tilt alarm sensor

The tilt of the vehicle is monitored.

The alarm system responds in situations such as attempts to steal a wheel or when the car is towed.

Interior motion sensor

The windows and glass sunroof must be closed for the system to function properly.

Avoiding unintentional alarms

The tilt alarm sensor and interior motion sensor can be switched off together, such as in the following situations:

- ▶ In automatic car washes.
- ▶ In duplex garages.
- ▶ During transport on trains carrying vehicles, at sea or on a trailer.
- ▶ With animals in the vehicle.

Switching off the tilt alarm sensor and interior motion sensor

- ▶  Press the remote control button again within 10 seconds as soon as the vehicle is locked.

The indicator lamp lights up for approx. 2 seconds and then continues to flash.

The tilt alarm sensor and interior motion sensor are turned off until the vehicle is locked again.

Switching off the alarm

- ▶ Unlock vehicle with the remote control or switch on the ignition, if needed through emergency detection of remote control, refer to page 35.
- ▶ With Comfort Access: if you are carrying the remote control on your person, grasp the driver side or front passenger side door handle completely.

Power windows

Information

WARNING

Unattended children or animals can move the vehicle and endanger themselves and traffic, e.g. with the following actions:



- ▷ Pressing the Start/Stop button.
- ▷ Releasing the parking brake.
- ▷ Opening and closing of doors or windows.
- ▷ Shifting the selector lever into neutral.
- ▷ Using vehicle equipment.

There is risk of accidents or injuries. Do not leave children or animals unattended in the vehicle. Carry remote control along when exiting and lock the vehicle. ◀

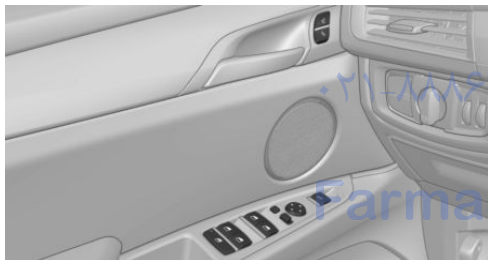
Overview



Opening



- ▷  Press the button to the resistance point.
The window opens while the switch is held.
- ▷  Press the switch beyond the resistance point.
The window opens automatically. Pressing the switch again stops the motion.

See also: Convenient opening, refer to page 38, via remote control.

Closing

WARNING

When operating the windows, body parts and objects can be jammed. There is risk of injuries or risk of property damage. Make sure that the area of movement of the windows is clear during opening and closing. ◀

- ▷  Pull the switch to the resistance point.
The window closes while the switch is held.
- ▷  Pull the switch beyond the resistance point.
The window closes automatically. Pulling again stops the motion.

See also: closing by means of Comfort Access, refer to page 42.

Pinch protection system

WARNING

When operating the windows, body parts and objects can be jammed. There is risk of injuries or risk of property damage. Make sure that the area of movement of the windows is clear during opening and closing. ◀

WARNING

Accessories on the windows such as antennas can impact jam protection. There is risk of injuries. Do not install accessories in the area of movement of the windows. ◀

If closing force exceeds a specific margin as a window closes, closing is interrupted.
The window reopens slightly.

Closing without the pinch protection system

WARNING

When operating the windows, body parts and objects can be jammed. There is risk of injuries or risk of property damage. Make sure that the area of movement of the windows is clear during opening and closing. ◀

In case of danger from the outside or if ice might prevent normal closing, proceed as follows:

1. Pull the switch past the resistance point and hold it there.
The pinch protection is limited and the window reopens slightly if the closing force exceeds a certain margin.
2. Pull the switch past the resistance point again within approx. 4 seconds and hold it there.
The window closes without jam protection.

Safety switch

General information

The safety switch in the driver's door can be used to prevent children, e.g., from opening and closing the rear windows using the switches in the rear.

Information

WARNING

When operating the windows, body parts and objects can be jammed. There is risk of injuries or risk of property damage. Make sure that the area of movement of the windows is clear during opening and closing. ◀

In order to prevent uncontrolled closing of the windows, press the safety switch, e.g. if children or animals are carried in the rear.

Switching on and off



Press button.

The LED lights up if the safety function is switched on.

Roller sunblinds

Roller sunblinds for the rear side windows

Pull out the roller sunblind at the loop and hook it onto the bracket.



WARNING

With closed roller sunblinds and open windows, the roller sunblinds can be loaded heavily while driving due to the wind. The roller sunblinds can be damaged and compromise the passengers. There is risk of injuries. Do not open the windows while driving if the roller sunblinds are closed. ◀

Glass sunroof, powered

General information

The glass sunroof and the sliding visor can be operated together or separately, using the same switch.

The glass sunroof is operational when the ignition is switched on.



Information



WARNING

Body parts can be jammed on operating the glass sunroof. There is risk of injuries. Make sure that the area of movement of the glass sunroof is clear during opening and closing. ◀



WARNING

Unattended children or animals can move the vehicle and endanger themselves and traffic, e.g. with the following actions:

- ▷ Pressing the Start/Stop button.
- ▷ Releasing the parking brake.
- ▷ Opening and closing of doors or windows.
- ▷ Shifting the selector lever into neutral.
- ▷ Using vehicle equipment.

There is risk of accidents or injuries. Do not leave children or animals unattended in the vehicle. Carry remote control along when exiting and lock the vehicle. ◀

The sliding visor opens, as long as the switch is held down. If the sliding visor is already fully open, the glass sunroof opens.

The glass sunroof closes as long as the switch is held down. If the glass sunroof is already closed or in the tilted position, the sliding visor closes.

- ▷ Press the switch in the desired direction past the resistance point.
The sliding visor opens automatically. If the sliding visor is already fully open, the glass sunroof opens automatically.
The glass sunroof closes automatically. If the glass sunroof is already closed or in the tilted position, the sliding visor closes automatically.
Pressing the switch upward stops the motion.

Tilting up and closing tilted glass sunroof



Push switch briefly upward.

- ▷ The closed glass sunroof is tilted and the sliding visor opens slightly.
- ▷ The opened glass sunroof closes until it is in its tilted position. The sliding visor does not move.
- ▷ The tilted glass sunroof is being closed. The sliding visor does not move.

Opening/closing the glass sunroof and sliding visor together

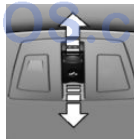

Briefly press the switch twice in succession in the desired direction past the resistance point.

The glass sunroof and sliding visor move together. Pressing the switch upward stops the motion.

- ▷ See also: Convenient opening, refer to page 38, via remote control.
- ▷ See also: closing by means of Comfort Access, refer to page 42.

Opening/closing the glass sunroof and sliding visor separately

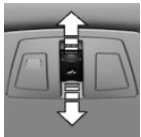

- ▷ Press the switch in the desired direction to the resistance point and hold it there.

Comfort position

If the glass sunroof is not automatically completely opened, the comfort position has been attained. In this position the wind noises in the interior are the least.

If desired, continue the movement by Pressing the switch.

Pinch protection system

If the closing force when closing the glass sunroof exceeds a certain value, the closing movement is stopped, beginning at approximately the middle of the opening in the roof, or from the tilted position during closing.

The glass sunroof reopens slightly.

WARNING

Body parts can be jammed on operating the glass sunroof. There is risk of injuries. Make sure that the area of movement of the glass sunroof is clear during opening and closing. ◀

Closing from the open position without pinch protection

If there is an external danger, proceed as follows:

1. Press the switch forward beyond the resistance point and hold.

The pinch protection is limited and the glass sunroof reopens slightly if the closing force exceeds a certain margin.

2. Press the switch forward again beyond the resistance point and hold until the glass sunroof closes without jam protection. Make sure that the closing area is clear.

Closing from the raised position without pinch protection

If there is an external danger, push the switch forward past the resistance point and hold it.

The glass sunroof closes without jam protection.

Initializing after a power failure

After a power failure during the opening or closing process, the glass sunroof can only be operated to a limited extent.

Initializing the system

The system can be initialized when the vehicle is stationary and the engine is running.

During the initialization, the glass sunroof closes without jam protection.

WARNING

Body parts can be jammed on operating the glass sunroof. There is risk of injuries. Make sure that the area of movement of the glass sunroof is clear during opening and closing. ◀

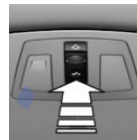

Press the switch up and hold it until the initialization is complete:

- ▶ Initialization begins within 15 seconds and is completed when the glass sunroof and sliding visor are completely closed.

- ▶ The glass sunroof closes without jam protection.

Adjusting

Vehicle features and options

This chapter describes all standard, country-specific and optional features offered with the series. It also describes features that are not necessarily available in your car, e. g., due to the selected options or country versions. This also applies to safety-related functions and systems. The respectively applicable country provisions must be observed when using the respective features and systems.

Sitting safely

The ideal seating position can make a vital contribution to relaxed, fatigue-free driving.

The seating position plays an important role in an accident in combination with:

- ▷ Safety belts, refer to page 55.
- ▷ Head restraints, refer to page 57.
- ▷ Airbags, refer to page 106.

Front seats

Information

WARNING
Seat adjustments while driving can lead to unexpected movements of the seat. Vehicle control could be lost. There is risk of an accident. Only adjust the side on the driver's side when the vehicle is stationary. ◀

WARNING
With a backrest inclined too far to the rear, the protective effect of the safety belt cannot be ensured anymore. There is a danger of sliding under the safety belt in an accident. There is risk of injuries or danger to life. Adjust the seat prior to starting the trip. Adjust the

backrest in an as upright position as possible and do not adjust again while driving. ◀

WARNING

There is risk of jamming when moving the seats. There is risk of injuries or risk of property damage. Make sure that the area of movement of the seat is clear prior to any adjustment. ◀

Electrically adjustable seats

Overview

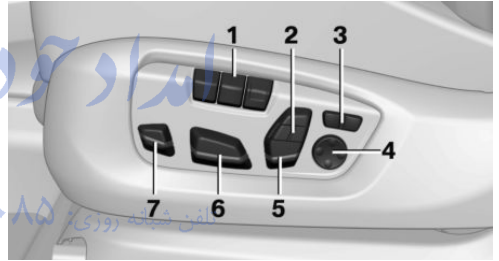

- 1 Seat, mirror, and steering wheel memory
- 2 Shoulder support
- 3 Backrest width
- 4 Lumbar support
- 5 Backrest, head restraint
- 6 Forward/back, height, tilt
- 7 Thigh support

General information

The seat setting for the driver's seat is stored for the profile currently used. When the vehicle is unlocked via the remote control, the position is automatically retrieved if the Function, refer to page 46, is activated for this purpose.

Adjustments in detail

1. Forward/backward

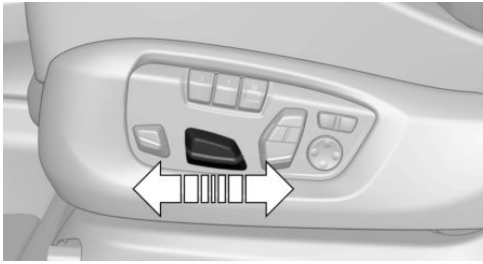

2. Height

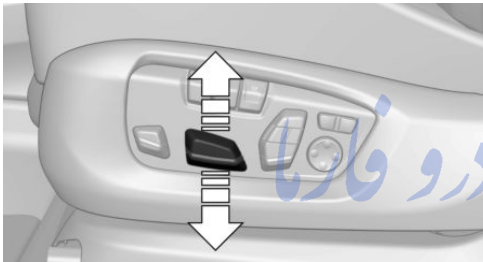

3. Seat tilt



4. Backrest tilt

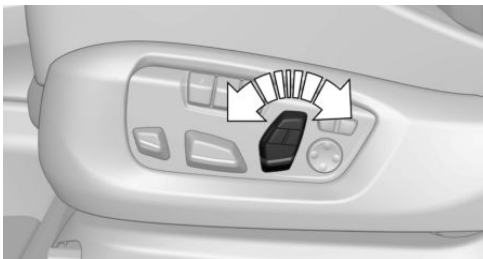

Thigh support

Multifunctional seat

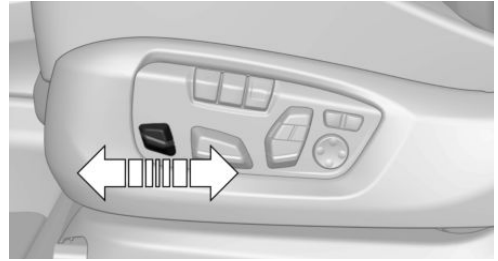

Adjust the position using the lever.

Sport seat

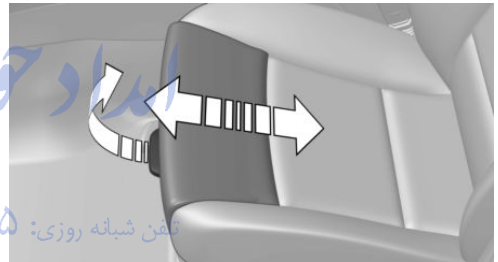

Pull the lever at the front of the seat and adjust the thigh support.

Lumbar support

The curvature of the seat backrest can be adjusted in a way that it supports the lumbar region of the spine. The lower back and the spine are supported for upright posture.



- ▶ Press the front/rear section of the switch:
The curvature is increased/decreased.
- ▶ Press the upper/lower section of the switch:
The curvature is shifted up/down.

Backrest width



Change the width of the backrest using the side wings to adjust the lateral support.

Shoulder support



Also supports the back in the shoulder area:

- ▷ Results in a relaxed seating position.
- ▷ Reduces strain on the shoulder muscles.

Front seat heating



Switching on



Press button once for each temperature level.

The maximum temperature is reached when three LEDs are lit.

If the journey is continued within approx. 15 minutes, the seat heating is activated automatically with the temperature selected last.

When ECO PRO, refer to page 196, is activated, the heater output is reduced.

Switch off



Press button longer.
The LEDs go out.

Temperature distribution

The heating action in the seat cushion and backrest can be distributed in different ways.

On the Control Display:

1. "Climate"
2. "Front seat heating"
3. Select the required seat.
4. Turn the controller to set the temperature distribution.

Active seat ventilation, front

The concept

The seat cushion and backrest surfaces are cooled by means of integrated fans.

The ventilation cools the seat, e. g., if the vehicle interior is overheated or for continuous cooling at high temperatures.

Overview



Active seat ventilation button

Switching on



Press button once for each ventilation level.

The highest level is active when three LEDs are lit.

After a short time, the system automatically moves down one level in order to prevent excessive cooling.

Switch off



Press button longer.
The LEDs go out.

Rear seats

Second row of seats

Information



WARNING

There is a risk of jamming when folding down the center armrest in the rear. There is risk of injuries. Make sure that the area of movement of the center armrest is clear during folding down. ◀

Rear seat heating



Switching on



Press button once for each temperature level.

The maximum temperature is reached when three LEDs are lit.

If the journey is continued within approx. 15 minutes, the seat heating is activated automatically with the temperature selected last.

When ECO PRO, refer to page 196, is activated, the heater output is reduced.

Switch off



Press button longer.
The LEDs go out.

Safety belts

Seats with safety belt

The vehicle has five seats, each of which is equipped with a safety belt.

General information

Always make sure that safety belts are being worn by all occupants before driving off.

For the occupants' safety the belt locking mechanism triggers early. Slowly guide the belt out of the holder when applying it.

Although airbags enhance safety by providing added protection, they are not a substitute for safety belts.

The upper shoulder strap's anchorage point will be correct for adult seat occupants of every build if the seat is correctly adjusted.

- ▷ The two outer safety belt buckles, integrated into the rear seat, are for passengers sitting on the left and right.
- ▷ The center rear safety belt buckle is solely intended for the center passenger.

Information



WARNING

If the safety belt is used by more than one person, the protective effect of the safety belt cannot be ensured anymore. There is risk of injuries or danger to life. Do not allow more than one person to wear a single safety belt. Infants and children are not allowed in an occupant's lap, but must be transported and respectively secured in designated child restraint systems. ◀

**WARNING**

The protective effect of the safety belts can be limited or lost when safety belts are fastened incorrectly. An incorrectly fastened safety belt can cause additional injuries, e.g. in the event of an accident or during braking and evasive maneuvers. There is risk of injuries or danger to life. Make sure that all occupants are wearing safety belts correctly. ◀

**WARNING**

With a rear backrest that is not locked, the protective function of the middle safety belt is not guaranteed. There is risk of injuries or danger to life. If you are using the middle safety belt, lock the wider rear backrest. ◀

Correct use of safety belts

- ▷ Wear the belt twist-free and as tight to your body as possible over your lap and shoulders.
- ▷ Wear the belt deep on your hips over your lap. The belt may not press on your stomach.
- ▷ Do not wear the belt on your throat, rub it on sharp edges, guide it or jam it in across hard or fragile objects.
- ▷ Avoid thick clothing.
- ▷ Re-tighten the belt frequently upward around your upper body.

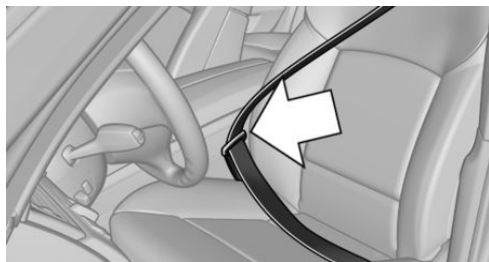
Buckling the belt

Make sure you hear the latch plate engage in the belt buckle.

To ease accessibility to the seat belt buckle, an adjustable slider is available on the belt to help position the buckle when not in use.

Tensioning the safety belt automatically

When the belt is closed, it is automatically tightened once after the release.

Unbuckling the belt

1. Hold the belt firmly.
2. Press the red button in the belt buckle.
3. Guide the belt back into its roll-up mechanism.

Safety belt reminder for driver's and passenger's seat

The indicator lamp lights up and a signal sounds. Make sure that the safety belts are positioned correctly. The safety belt reminder is active at speeds above approx. 6 mph/10 km/h. It can also be activated if objects are placed on the front passenger seat.

Safety mode

In critical situations, e.g., during full brake application, the front safety belts tighten automatically.

If the situation passes without an accident occurring, the belt tension relaxes.

If the belt tension does not loosen automatically, stop the vehicle and unbuckle the belt using the red button in the buckle. Fasten the belt before continuing on your trip.

Damage to safety belts**WARNING**

The protective effect of the safety belts may not be fully functional or fail in the following situations:

- ▶ Safety belts are damaged, soiled or changed in any other way.
- ▶ Safety belt buckle is damaged or heavily soiled.
- ▶ Belt tensioners or belt retractors were modified.

Safety belts can be imperceptibly damaged in the event of an accident. There is risk of injuries or danger to life. Do not modify safety belts, safety belt buckles, belt tensioners, belt retractors or belt anchors and keep them clean. Have the safety belts checked after an accident at the dealer's service center or another qualified service center or repair shop. ◀

Wear and tear after accidents or when damaged otherwise:

Have the safety belts, including the safety belt tensioners, replaced and have the belt anchors checked.

Head restraints

Information



WARNING

A missing protective effect due to removed or not correctly adjusted head restraints can cause injuries in the head and neck area. There is risk of injuries. Install head restraints on occupied seats prior to driving and make sure that the center of the head restraint supports the back of the head at eye level. ◀



WARNING

Objects on the head restraint reduce the protective effect in the head and neck area. There is risk of injuries.

- ▶ Do not use seat or head restraint covers.
- ▶ Do not hang objects, e.g., clothes hangers, directly on the head restraint.

- ▶ Only use accessories that have been determined to be safe for attachment to a head restraint.
- ▶ Do not use any accessories, e.g. pillows, while driving. ◀

Correctly adjusted head restraint

General information

A correctly adjusted head restraint reduces the risk of injury to cervical vertebrae in the event of an accident.

Height

Adjust the head restraint so that its center is approximately at ear level.

Distance

Adjust the distance so that the head restraint is as close as possible to the back of the head.

Active head restraint

In the event of a rear-end collision with a certain severity, the active head restraint automatically reduces the distance from the head.

Wear and tear after accidents or when damaged otherwise:

Have the active headrest checked and if needed replaced.

Adjusting the height: electrical head restraints

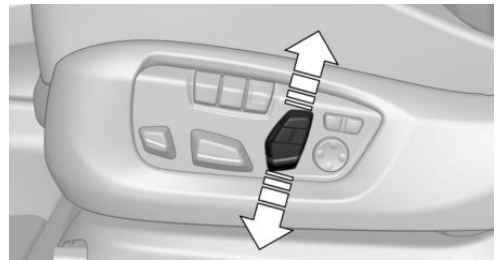

Adjusting electrically.

Distance to the back of the head: electrical head restraints

The head restraint is automatically repositioned when the shoulder support is adjusted.

Adjusting the side extensions

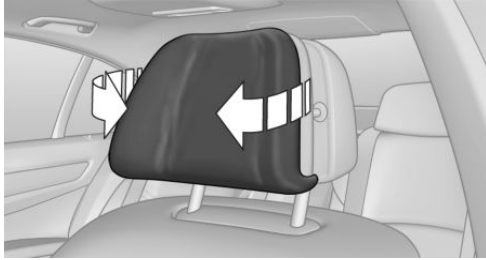

Fold forward for increased lateral support in the resting position.

Removing

The head restraints cannot be removed.

Seat, mirror, and steering wheel memory

The concept

Two driver's seat and exterior mirror positions can be stored per profile, refer to page 35, and called up. Settings for the backrest width and lumbar support are not stored in memory.

Information

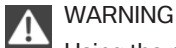

WARNING

Using the memory function while driving can lead to unexpected seat or steering wheel movements. Vehicle control could be lost. There is risk of an accident. Only retrieve the memory function when the vehicle is stationary. ◀



WARNING

There is risk of jamming when moving the seats. There is risk of injuries or risk of property damage. Make sure that the area of movement of the seat is clear prior to any adjustment. ◀

Overview



Storing

1. Switch on the ignition.
2. Set the desired position.

3.  Press button briefly. The LED in the button lights up.
4. Press selected button 1 or 2 while the LED is lit. The LED goes out.

If the SET button is pressed accidentally:

-  Press button again.
The LED goes out.

Calling up settings

Comfort function

1. Open the driver's door.
2. If necessary, switch off the ignition.
3. Briefly press the desired button 1 or 2.

The corresponding seat position is performed automatically.

The procedure stops when a switch for adjusting the seat or one of the buttons is pressed.

Safety mode

1. Close the driver's door or switch on the ignition.
2. Press and hold the desired button 1 or 2 until the adjustment procedure is completed.

Calling up of a seat position deactivated

After a brief period, calling up stored seat positions is deactivated to save battery power.

To reactivate calling up of a seat position:

- ▷ Open or close the door or tailgate.
- ▷ Press a button on the remote control.
- ▷ Press the Start/Stop button.

Mirrors

Exterior mirrors

General information

The mirror on the passenger side is more curved than the driver's side mirror.

Depending on the vehicle equipment, the mirror setting is stored for the profile currently used. When the vehicle is unlocked via the remote control, the position is automatically retrieved if this function is active.

Information



WARNING

Objects reflected in the mirror are closer than they appear. The distance to the traffic behind could be incorrectly estimated, e.g. while changing lanes. There is risk of an accident. Estimate the distance to the traffic behind by looking over your shoulder. ◀

Overview



- 1 Adjusting 59
- 2 Left/right, Automatic Curb Monitor
- 3 Fold in and out 60

Selecting a mirror



To change over to the other mirror:
Slide the switch.

Adjusting electrically



The setting corresponds to the direction in which the button is pressed.

Saving positions

Seat, mirror, and steering wheel memory, refer to page 58.

Adjusting manually

In case of electrical malfunction press edges of mirror.

Automatic Curb Monitor

The concept

If reverse gear is engaged, the mirror glass on the front passenger side is tilted downward. This improves your view of the curb and other low-lying obstacles when parking, e.g.

Activating

1.  Slide the switch to the driver's side mirror position.
2. Engage selector lever position R.

Deactivating

Slide the switch to the passenger side mirror position.

Fold in and out

CAUTION

Depending on the vehicle width, the vehicle can be damaged in car washes. There is risk of property damage. Before washing, fold in the mirrors by hand or with the button. ◀

 Press button.

Possible at speeds up to approx. 15 mph/20 km/h.

Beneficial in the following situations:

- ▷ In car washes.
- ▷ On narrow roads.
- ▷ For folding mirrors back out that were folded away manually.

Mirrors that were folded in are folded out automatically at a speed of approx. 25 mph/40 km/h.

Automatic heating

Both exterior mirrors are automatically heated whenever the engine is running.

Automatic dimming feature

Both exterior mirrors are automatically dimmed. Photocells are used to control the Interior rearview mirror, refer to page 60.

Interior rearview mirror, automatic dimming feature

The concept

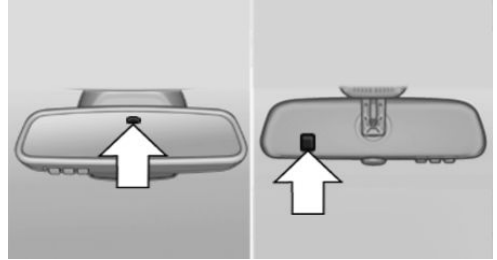

Photocells are used for control:

- ▷ In the mirror glass.
- ▷ On the back of the mirror.

Functional requirement

For proper operation:

- ▷ Keep the photocells clean.
- ▷ Do not cover the area between the inside rearview mirror and the windshield.

Steering wheel

Information

WARNING

Steering wheel adjustments while driving can lead to unexpected steering wheel movements. Vehicle control could be lost. There is risk of an accident. Adjust the steering wheel while the vehicle is stationary only. ◀

Power steering wheel adjustment

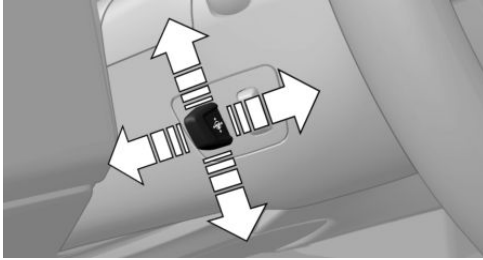

The steering wheel can be adjusted in four directions.

Storing the position

Seat, mirror, and steering wheel memory, refer to page 58.

Heated steering wheel



Press button.

- ▷ On: the LED lights up.
- ▷ Off: the LED goes out.

Transporting children safely

Vehicle features and options

This chapter describes all standard, country-specific and optional features offered with the series. It also describes features that are not necessarily available in your car, e. g., due to

the selected options or country versions. This also applies to safety-related functions and systems. The respectively applicable country provisions must be observed when using the respective features and systems.

The right place for children

Information

WARNING

Unattended children or animals can move the vehicle and endanger themselves and traffic, e.g. with the following actions:

- ▷ Pressing the Start/Stop button.
- ▷ Releasing the parking brake.
- ▷ Opening and closing of doors or windows.
- ▷ Shifting the selector lever into neutral.
- ▷ Using vehicle equipment.

There is risk of accidents or injuries. Do not leave children or animals unattended in the vehicle. Carry remote control along when exiting and lock the vehicle. ◀

Children should always be in the rear

WARNING

Persons shorter than 5 ft, 150 cm cannot correctly fasten the safety belt without suitable additional restraint systems. The protective effect of the safety belts can be limited or lost when safety belts are fastened incorrectly. An incorrectly fastened safety belt can cause additional injuries, e.g. in the event of an accident or during braking and evasive maneuvers. There is risk of injuries or danger to life. Secure persons shorter than 5 ft, 150 cm using suitable restraint systems. ◀

Accident research shows that the safest place for children is in the back seat.

Only transport children younger than 13 years of age or shorter than 5 ft, 150 cm in the rear in child restraint systems provided in accordance with the age, weight and size of the child.

Children 13 years of age or older must wear a safety belt as soon as a suitable child restraint system can no longer be used due to their age, weight and size.

Children on the front passenger seat

Should it ever be necessary to use a child restraint system in the front passenger seat, make sure that the front, knee and side airbags on the front passenger side are deactivated.

Automatic deactivation of front-seat passenger airbags, refer to page 108.

Information

WARNING

Active front-seat passenger airbags can injure a child in a child restraint system when the airbags are activated. There is risk of injuries. Make sure that the front-seat passenger airbags are deactivated and that the PASSENGER AIRBAG OFF indicator lamp lights up. ◀

WARNING

The stability of the child restraint system is limited or compromised with incorrect seat adjustment or improper installation of the child seat. There is risk of injuries or danger to life. Make sure that the child restraint system fits

securely against the backrest. If possible, adjust the backrest tilt for all affected backrests and correctly adjust the seats. Make sure that seats and backrests are securely engaged. If possible, adjust the height of the head restraints or remove them. ◀

Installing child restraint systems

Information

Pay attention to the specifications of the child restraint system manufacturer when selecting, installing, and using child restraint systems.

WARNING

The stability of the child restraint system is limited or compromised with incorrect seat adjustment or improper installation of the child seat. There is risk of injuries or danger to life. Make sure that the child restraint system fits securely against the backrest. If possible, adjust the backrest tilt for all affected backrests and correctly adjust the seats. Make sure that seats and backrests are securely engaged. If possible, adjust the height of the head restraints or remove them. ◀

On the front passenger seat

Deactivating airbags

WARNING

Active front-seat passenger airbags can injure a child in a child restraint system when the airbags are activated. There is risk of injuries. Make sure that the front-seat passenger airbags are deactivated and that the PASSENGER AIRBAG OFF indicator lamp lights up. ◀

After installing a child restraint system in the front passenger seat, make sure that the front, knee and side airbags on the front passenger side are deactivated.

Deactivate the front-seat passenger airbags automatically, refer to page 108.

Seat position and height

Before installing a child restraint system, move the front passenger seat as far back as possible and adjust its height to the highest and thus best possible position for the belt and to offer optimal protection in the event of an accident.

If the upper anchorage of the safety belt is located in front of the belt guide of the child seat, move the passenger seat carefully forward until the best possible belt guide position is reached.

Backrest width

Adjustable backrest width: before installing a child restraint system in the front passenger seat, open the backrest width completely. Do not change the backrest width again and do not call up a memory position.

Child seat security



The rear safety belts and the front passenger safety belt can be permanently locked to fasten child restraint systems.

The front passenger safety belt can be permanently locked to fasten child restraint systems.

Locking the safety belt

1. Pull out the strap completely.
2. Secure the child restraint system with the belt.

3. Allow the strap to be pulled in and pull it tight against the child restraint system. The safety belt is locked.

Unlocking the safety belt

1. Unbuckle the belt buckle.

LATCH child restraint system

LATCH: Lower Anchors and Tether for Children.

Information

LATCH: Lower Anchors and Tether for Children.

Pay attention to the operating and safety information of the child restraint system manufacturer when installing and using LATCH child restraint fixing system.

Mounts for the lower LATCH anchors

The lower anchors may be used to attach the CRS to the vehicle seat up to a combined child and CRS weight of 65 lb/30 kg when the child is restrained by the internal harnesses.

Information

WARNING

If the LATCH child restraint fixing systems are not correctly engaged, the protective effect of the LATCH child restraint fixing system can be limited. There is risk of injuries or danger to life. Make sure that the lower anchors are securely engaged and that the LATCH child restraint fixing system fits securely against the backrest. ◀

Position



The corresponding symbol shows the mounts for the lower LATCH anchors.



Seats equipped with lower anchors are marked with a pair, 2, of LATCH symbols. It is not recommended to use the

2. Remove the child restraint system.
3. Allow the strap to be pulled in completely.

inner lower anchors of standard outer LATCH positions to fasten a child restraint system on the middle seat. Use the vehicle seat belt instead for the middle seat.

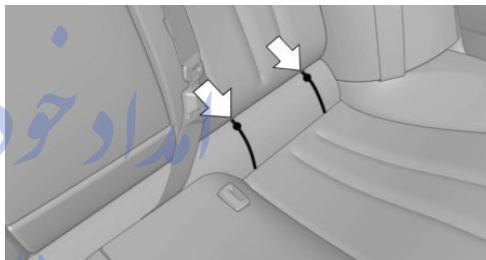

Mounts for the lower LATCH anchors are located behind the seat cover between the backrest and the seat cushion.

Open the zipper to access the anchors.

Before installing LATCH child restraint systems

Pull the belt away from the area of the child restraint system.

Assembly of LATCH child restraint systems

1. Install child restraint system, see manufacturer's information.
2. Ensure that both LATCH anchors are properly connected.

Child restraint fixing system with a tether strap

Mounting points



The respective symbol shows the anchor for the upper retaining strap.

Seats with an upper Top Tether are marked with this symbol. It can be found on the rear seat backrest or the rear window shelf.

Information



CAUTION

The mounting points for the upper retaining straps of child restraint systems are only provided for these retaining straps. When other objects are mounted, the anchors can be damaged. There is risk of property damage. Only mount child restraint systems to the upper retaining straps. ◀

Retaining strap guide



WARNING

If the upper retaining strap is incorrectly used for the child restraint system, the protective effect can be reduced. There is risk of injuries. Make sure that the upper retaining strap is not guided across sharp edges and without twisting to the upper retaining strap. ◀

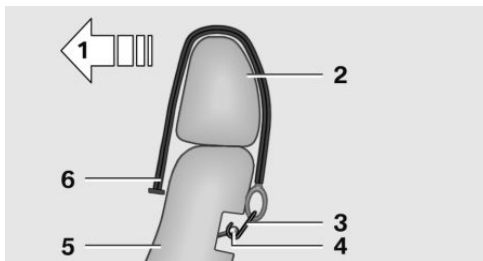

- 1 Direction of travel
- 2 Head restraint
- 3 Hook for upper retaining strap
- 4 Mounting point/eye

- 5 Seat backrest
- 6 Upper retaining strap

Attaching the upper retaining strap to the mounting point

1. Middle seat: raise the head restraint if needed.
2. Outer seats: guide the upper retaining strap over the head restraint.

Middle seat: guide the upper retaining strap between the supports of the head restraint.

3. If there is a retaining strap, run it between the backrest and the cargo cover.
4. Attach the hook of the retaining strap to the mounting eye.
5. Tighten the retaining strap by pulling it down.
6. Middle seat: lower and lock head restraints as needed.

Securing of doors and windows in the rear

Rear doors

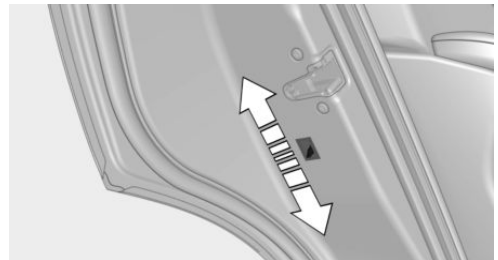

Push the locking lever on the rear doors up.

The door can now be opened from the outside only.

Safety switch for the rear



Press button on the driver's door if children are being transported in the rear.

This locks various functions so that they cannot be operated from the rear: safety switch, refer to page 49.

امداد خودرو فارما

تلفن شبانه روزی: ۰۲۱-۸۸۸۶۲۰۸۵

FarmaSOS.com

Driving

Vehicle features and options

This chapter describes all standard, country-specific and optional features offered with the series. It also describes features that are not necessarily available in your car, e. g., due to the selected options or country versions. This also applies to safety-related functions and systems. The respectively applicable country provisions must be observed when using the respective features and systems.

Start/Stop button

The concept



Pressing the Start/Stop button switches the ignition on or off and starts the engine.

The engine starts with the brake pedal pressed when you press the Start/Stop button.

Ignition on

Press the Start/Stop button, and do not press on the brake pedal at the same time.

All vehicle systems are ready for operation.

Most of the indicator and warning lights in the instrument cluster light up for a varied length of time.

To save battery power when the engine is off, switch off the ignition and any unnecessary electronic systems/power consumers.

Ignition off

Press the Start/Stop button again without stepping on the brake.

All indicator lights in the instrument cluster go out.

To save battery power when the engine is off, switch off the ignition and any unnecessary electronic systems/power consumers.

Information

When switching off the ignition, the selector lever position P is selected automatically if the selector lever position D or R is selected.

The ignition is switched off automatically in the following situations while the vehicle is stationary and the engine is off:

- ▷ When locking the vehicle, and when the low beams are activated.
- ▷ Shortly before the battery is discharged completely, so that the engine can still be started.
- ▷ When opening or closing the driver door, if the driver's safety belt is unbuckled and the low beams are turned off.
- ▷ While the driver's safety belt is unbuckled with driver's door open and low beams off.

The low beams switch to parking lights after approx. 15 minutes of no use.

Radio ready state

Activate radio-ready state: when the engine is running: press the Start/Stop button.

Some electronic systems/power consumers remain ready for operation.

The radio-ready state is switched off automatically in the following situations:

- ▷ After approx. 8 minutes.
- ▷ When the vehicle is locked using the central locking system.
- ▷ Shortly before the battery is discharged completely, so that the engine can still be started.

The radio-ready state remains active if, e.g., the ignition is automatically switched off for the following reasons:

- ▷ Opening or closing the driver's door.
- ▷ Unfastening of the driver's safety belt.
- ▷ When automatically switching from low beams to parking lights.

If the engine is switched off and the ignition is switched on, the system automatically switches to the radio-ready state if the lights are turned off or, if correspondingly equipped, the daytime running lights are activated.

Starting the engine

Information



DANGER

If the exhaust pipe is blocked or ventilation is insufficient, harmful exhaust gases can enter into the vehicle. The exhaust gases contain carbon monoxide, an odorless and colorless but highly toxic gas. In enclosed areas, exhaust gases can also accumulate outside of the vehicle. There is danger to life. Keep the exhaust pipe free and ensure sufficient ventilation. ◀

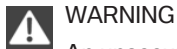

WARNING

An unsecured vehicle can put itself into motion and roll away. There is risk of an accident. Before exiting, secure the vehicle against rolling.

In order to ensure that the vehicle is secured against rolling away, observe the following:

- ▷ Set the parking brake.
- ▷ On uphill grades or on a slope, turn the front wheels in the direction of the curb.
- ▷ On uphill grades or on a slope, also secure the vehicle, e.g. with a wheel chock. ◀



CAUTION

In the case of repeated starting attempts or repeated starting in quick succession, the fuel is not burned or is inadequately burned. The catalytic converter can overheat. There is risk of property damage. Avoid repeated starting in quick succession. ◀

Steptronic transmission

Starting the engine

1. Depress the brake pedal.
2. Press the Start/Stop button.

The ignition is activated automatically for a certain time and is stopped as soon as the engine starts.

Engine stop

Information



WARNING

Unattended children or animals can move the vehicle and endanger themselves and traffic, e.g. with the following actions:

- ▷ Pressing the Start/Stop button.
- ▷ Releasing the parking brake.
- ▷ Opening and closing of doors or windows.
- ▷ Shifting the selector lever into neutral.
- ▷ Using vehicle equipment.

There is risk of accidents or injuries. Do not leave children or animals unattended in the vehicle. Carry remote control along when exiting and lock the vehicle. ◀



WARNING

An unsecured vehicle can put itself into motion and roll away. There is risk of an accident. Before exiting, secure the vehicle against rolling.

In order to ensure that the vehicle is secured against rolling away, observe the following:

- ▷ Set the parking brake.
- ▷ On uphill grades or on a slope, turn the front wheels in the direction of the curb.
- ▷ On uphill grades or on a slope, also secure the vehicle, e.g. with a wheel chock. ◀

Before driving into a car wash

So that the vehicle can roll into a car wash observe instructions for going into an automatic car wash, refer to page 243.

Steptronic transmission

Switching off the engine

1. Engage selector lever position P with the vehicle stopped.
2. Press the Start/Stop button.
The engine is switched off.
The radio-ready state is switched on.
3. Set the parking brake.

Auto Start/Stop function

The concept

The Auto Start/Stop function helps save fuel. The system switches off the engine during a stop, e.g., in traffic congestion or at traffic lights. The ignition remains switched on. The engine starts again automatically for driving off.

Automatic mode

After every start of the engine using the Start/Stop button, the Auto Start/Stop function is in the last selected state, refer to page 70.

When the Auto Start/Stop function is active, it is available when the vehicle is traveling faster than about 3 mph, approx. 5 km/h.

Engine stop

The engine is switched off automatically during a stop under the following conditions:

Steptronic transmission:

- ▷ The selector lever is in selector lever position D.
- ▷ The brake pedal remains pressed while the vehicle is stationary or the vehicle is held by Automatic Hold.
- ▷ The driver's safety belt is buckled or the driver's door is closed.

The air flow from the air conditioner is reduced when the engine is switched off.

Displays in the instrument cluster



The display indicates that the Auto Start/Stop function is ready for an Automatic engine start.



The display indicates that the conditions for an automatic engine stop have not been met.

Functional limitations

The engine is not switched off automatically in the following situations:

- ▷ External temperature too low.
- ▷ The external temperature is high and automatic climate control is running.
- ▷ The car's interior has not yet been heated or cooled to the required level.
- ▷ The engine is not yet at operating temperature.
- ▷ The wheels are at a sharp angle or the steering wheel is being turned.
- ▷ After driving in reverse.
- ▷ Fogging of the windows when the automatic climate control is switched on.
- ▷ Vehicle battery is heavily discharged.
- ▷ At higher elevations.
- ▷ The engine compartment lid is unlocked.

- ▷ HDC Hill Descent Control is activated.
- ▷ The parking assistant is activated.
- ▷ Stop-and-go traffic.
- ▷ Selector lever in selector lever position N, M/S or R.
- ▷ Use of fuel with high ethanol content.

Starting the engine

The engine starts automatically under the following conditions:

- ▷ Steptronic transmission:
By releasing the brake pedal.
When Automatic Hold is activated: press the accelerator pedal.

After the engine starts, accelerate as usual.

Safety mode

After the engine switches off automatically, it will not start again automatically if any one of the following conditions are met:

- ▷ The driver's safety belt is unbuckled and the driver's door is open.
- ▷ The hood was unlocked.

Some indicator lights light up for a varied length of time.

The engine can only be started via the Start/Stop button.

Functional limitations

Even if driving off was not intended, the deactivated engine starts up automatically in the following situations:

- ▷ Excessive warming of the car's interior when the cooling function is switched on.
- ▷ The steering wheel is turned.
- ▷ Steptronic transmission: change from selector lever position D to R, N or M/S.
- ▷ Steptronic transmission: change from selector lever position P to N, D, R or M/S.
- ▷ Fogging of the windows when the automatic climate control is switched on.

- ▷ Vehicle battery is heavily discharged.
- ▷ Excessive cooling of the car's interior when the heating is switched on.

Activating/deactivating the system manually

Using the button



Press button.

- ▷ LED comes on: Auto Start/Stop function is deactivated.
The engine is started during an automatic engine stop.
The engine can only be stopped or started via the Start/Stop button.
- ▷ LED goes out: Auto Start/Stop function is activated.

Switching off the vehicle during an automatic engine stop

During an automatic engine stop, the vehicle can be switched off permanently, e. g., when leaving it.

1. Press the Start/Stop button. The ignition is switched off. The Auto Start/Stop function is deactivated.
Selector lever position P is engaged automatically.
2. Set the parking brake.

Engine start as usual via Start/Stop button.

Automatic deactivation

In certain situations, Auto Start/Stop function is deactivated automatically for safety reasons as if the driver were absent.

Malfunction

The Auto Start/Stop function no longer switches off the engine automatically. A Check Control message is displayed. It is possible to continue driving. Have the system checked.

Parking brake

The concept

The parking brake is used to prevent the vehicle from rolling when it is parked.

Overview



 Parking brake

Setting

 **WARNING**

An unsecured vehicle can put itself into motion and roll away. There is risk of an accident. Before exiting, secure the vehicle against rolling.

In order to ensure that the vehicle is secured against rolling away, observe the following:

- ▷ Set the parking brake.
- ▷ On uphill grades or on a slope, turn the front wheels in the direction of the curb.

- ▷ On uphill grades or on a slope, also secure the vehicle, e.g. with a wheel chock. ◀

 **WARNING**

Unattended children or animals can move the vehicle and endanger themselves and traffic, e.g. with the following actions:

- ▷ Pressing the Start/Stop button.
- ▷ Releasing the parking brake.
- ▷ Opening and closing of doors or windows.
- ▷ Shifting the selector lever into neutral.
- ▷ Using vehicle equipment.

There is risk of accidents or injuries. Do not leave children or animals unattended in the vehicle. Carry remote control along when exiting and lock the vehicle. ◀

 Pull the switch.
The LED lights up.

 The indicator lamp lights up red. The parking brake is set.

تلفن شماره روزی: ۰۲۰۸۸۶۲۰۸۵
While driving

Use as emergency brake while driving:

Pull the switch and hold it. The vehicle brakes hard while the switch is being pulled.

 The indicator lamp lights up red, a signal sounds and the brake lights light up.

A Check Control message is displayed.

If the vehicle is slowed down to a speed of approx. 2 mph/3 km/h the parking brake is set.

Releasing

With the ignition switched on:

 **Steptronic transmission:** Press the switch while the brake is pressed or selector lever position P is set.

The LED and indicator lamp go out.

The parking brake is released.

Automatic release in cars with Steptronic transmission

For automatic release, step on the accelerator pedal.

The LED and indicator lamp go out.

The parking brake is automatically released when you step on the accelerator:

- ▷ Engine on.
- ▷ Drive mode engaged.
- ▷ Driver buckled in and doors closed.

Automatic Hold

The concept

This system assists the driver by automatically setting and releasing the brake, such as when moving in stop-and-go traffic.

The vehicle is automatically held in place when it is stationary.

On inclines, the system prevents the vehicle from rolling backward when driving off.

Overview



 Automatic Hold

Safety information

 **WARNING**

An unsecured vehicle can put itself into motion and roll away. There is risk of an accident. Before exiting, secure the vehicle against rolling.

In order to ensure that the vehicle is secured against rolling away, observe the following:

- ▷ Set the parking brake.
- ▷ On uphill grades or on a slope, turn the front wheels in the direction of the curb.
- ▷ On uphill grades or on a slope, also secure the vehicle, e.g. with a wheel chock. ◀

Under the following conditions, Automatic Hold is automatically deactivated and the parking brake is set:

- ▷ The engine is switched off.
- ▷ A door is opened and driver's safety belt is unbuckled while the vehicle is stationary.
- ▷ The moving vehicle is brought to a standstill using the parking brake.



The indicator lamp switches from green to red and the letters AUTO H go out.

Activating

This function can be activated when the driver's door is closed, the safety belt is fastened and the engine is running.



Press button.

The LED and the letters AUTO H light up.



The indicator lamp lights up.
Automatic Hold is activated.

Deactivating



Press button again.

The LED and the letters AUTO H go out.

Automatic Hold is deactivated.

If the vehicle is being held by Automatic Hold, press on the brake pedal to deactivate it.

When the parking brake is set manually, Automatic Hold is deactivated automatically.

Driving

Automatic Hold is activated: the vehicle is automatically secured against rolling after braking to a standstill.



The indicator lamp lights up green.

Step on the accelerator pedal to drive off.

The brake is released automatically.

The indicator lamp goes out.



CAUTION

If the vehicle is stationary, Automatic Hold engages the parking brake. It prevents the vehicle from rolling in a car wash. There is risk of property damage. Deactivate Automatic Hold prior to entering the car wash. ◀

Parking

The parking brake is automatically set if the engine is switched off while the vehicle is being held by Automatic Hold.



The indicator lamp changes from green to red.

The parking brake is not set if the engine is switched off while the vehicle is coasting to a halt. Automatic Hold is deactivated.

Automatic Hold remains activated during the engine stop brought about by the Auto Start/Stop function.



WARNING

Unattended children or animals can move the vehicle and endanger themselves and traffic, e.g. with the following actions:

- ▶ Pressing the Start/Stop button.
- ▶ Releasing the parking brake.
- ▶ Opening and closing of doors or windows.
- ▶ Shifting the selector lever into neutral.
- ▶ Using vehicle equipment.

There is risk of accidents or injuries. Do not leave children or animals unattended in the vehicle. Carry remote control along when exiting and lock the vehicle. ◀

Malfunction

In the event of a failure or malfunction of the parking brake, secure the vehicle against rolling using a wheel chock, e.g., when leaving it.

Manual release



WARNING

An unsecured vehicle can put itself into motion and roll away. There is risk of an accident. Before exiting, secure the vehicle against rolling.

In order to ensure that the vehicle is secured against rolling away, observe the following:

- ▶ Set the parking brake.
- ▶ On uphill grades or on a slope, turn the front wheels in the direction of the curb.
- ▶ On uphill grades or on a slope, also secure the vehicle, e.g. with a wheel chock. ◀

The parking brake can be released manually in the event of a power failure or electrical fault.

Unlocking

If the parking brake has been released manually in response to a malfunction, only qualified technicians should return it to operation.

1. Open the left side trim in the trunk.
2. Remove the first-aid kit and warning triangle.
3. Insert the screwdriver from the onboard vehicle tool kit under the cargo floor panel into the strap of the release point, see arrow.
4. Forcefully pull the screwdriver up against the mechanical resistance until you notice

a marked increase in the resistance and the parking brake releases audibly.

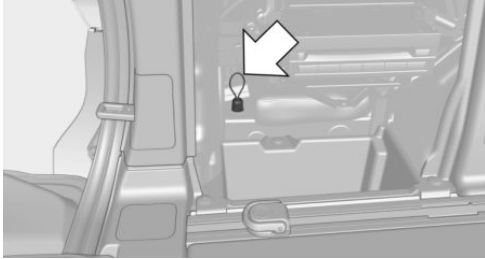

5. Stow the screwdriver, warning triangle and first-aid kit, and close the left side trim in the trunk.

After a power failure



WARNING

The function of the parking brake is not ensured if it was unlocked manually without power loss. There is risk of an accident. Only operate the parking brake if it was unlocked manually due to a power loss. ◀

Putting the parking brake into operation

1. Switch on the ignition.
2.  Press the switch while stepping on the brake pedal or selector lever position P is set.

It may take several seconds for the brake to be put into operation. Any sounds associated with this are normal.



The indicator lamp in the instrument cluster goes out as soon as the parking brake is ready for operation.

Turn signal, high beams, headlight flasher

Turn signal

Turn signal in exterior mirror

When driving and during operation of the turn signals or hazard warning system, do not fold in the exterior mirrors, so that the signal lights on the exterior mirror are easy to see.

Using turn signals

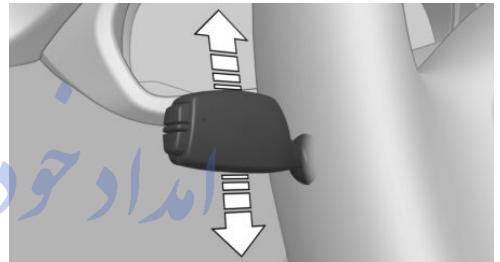

Press the lever beyond the resistance point.

The turn signal lever returns into its starting position after actuation.

To switch off manually, slightly tap the lever to the resistance point.

Triple turn signal activation

Slightly tap lever.

The turn signal flashes three times.

The function can be activated or deactivated.

On the Control Display:

1. "Settings"
2. "Lighting"
3. "Triple turn signal"

Settings are stored for the profile currently used.

Signaling briefly

Press the lever to the resistance point and hold it there for as long as you want the turn signal to flash.

Malfunction

Unusually rapid flashing of the indicator lamp indicates that a turn signal bulb has failed.

High beams, headlight flasher

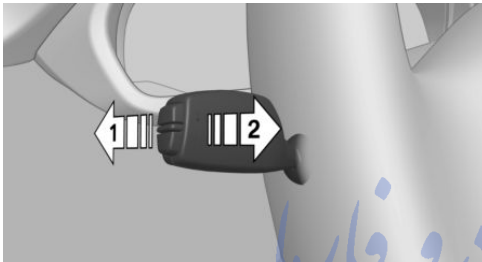

- ▷ High beams, arrow 1.
- ▷ High beams off/headlight flasher, arrow 2.

Washer/wiper system

Switching the wipers on/off and brief wipe

General information

Do not use the wipers if the windshield is dry, as this may damage the wiper blades or cause them to become worn more quickly.

Information

CAUTION

If the wipers are frozen to the windshield, the wiper blades can be torn off and the wiper motor overheat on switching on. There is risk of property damage. Defrost the windshield prior to switching the wipers on. ◀

WARNING

If the wipers start moving in the folded away state, damage may occur to parts of the vehicle or body parts can be jammed. There is risk of injuries or risk of property damage. Make sure that the vehicle is switched off when the wipers are in the folded away state and the wipers are folded in when switching on. ◀

Switching on

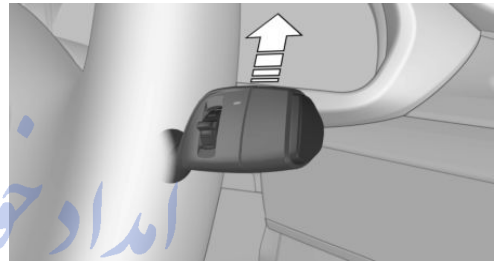

The lever automatically returns to its initial position when released.

- ▷ Normal wiper speed: tap up once.

The wipers switch to intermittent operation when the vehicle is stationary.

- ▷ Fast wiper speed: tap up twice or tap once beyond the resistance point.

Wipers change to normal speed when vehicle comes to standstill.

Switch off and brief wipe

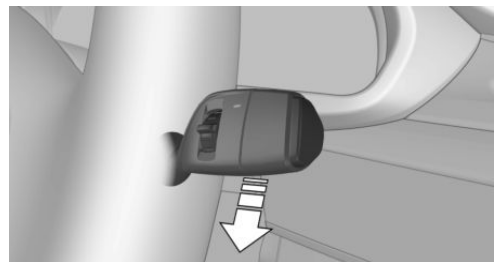

The lever automatically returns to its initial position when released.

- ▷ Single wipe: press down once.

- ▷ To switch off from normal wiper speed: press down once.
- ▷ To switch off from fast wiper speed: press down twice.

Interval mode or rain sensor

The concept

Without the rain sensor, the frequency of the wiper operation is preset.

The rain sensor automatically controls the time between wipes depending on the intensity of the rainfall. The sensor is located on the windshield, directly behind the interior rearview mirror.

Activating/deactivating

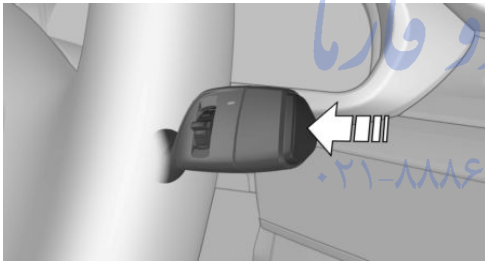

Press button on the wiper lever.

Wiping is started. If the vehicle is equipped with a rain sensor: LED in wiper lever lights up.

When wipers are frozen to windshield, wiper operation is deactivated.

During trip interruption with the rain sensor switched on: if the trip is resumed within approx. 15 minutes, the rain sensor is automatically activated again.



CAUTION

If the rain sensor is activated, the wipers can accidentally start moving in car washes. There is risk of property damage. Deactivate the rain sensor in car washes. ◀

Setting the frequency or sensitivity of the rain sensor

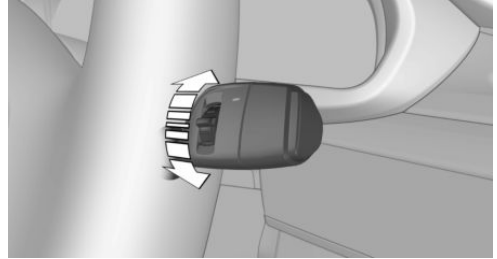

Turn the thumbwheel to adjust the frequency or sensitivity of the rain sensor.

Up: short interval or high sensitivity of the rain sensor.

Down: long interval or low sensitivity of the rain sensor.

Clean the windshield, headlights



Pull the wiper lever towards you.

The system sprays washer fluid on the windshield and activates the wipers briefly.

In addition, the headlights are cleaned at regular intervals when the vehicle's lights are activated.



WARNING

The washer fluid can freeze onto the window at low temperatures and obstruct the view. There is risk of an accident. Only use the washer systems, if the washer fluid cannot freeze. Use antifreeze if needed. ◀

**CAUTION**

When the wiper water container is empty, the wash pump cannot work as intended. There is risk of property damage. Do not use the washer system when the wash water container is empty. ◀

Windshield washer nozzles

The windshield washer nozzles are automatically heated while the ignition is switched on.

Fold-out position of the wipers

Fold wipers back when you want to change the blades or with pending low temperatures.

**WARNING**

If the wipers start moving in the folded away state, damage may occur to parts of the vehicle or body parts can be jammed. There is risk of injuries or risk of property damage. Make sure that the vehicle is switched off when the wipers are in the folded away state and the wipers are folded in when switching on. ◀

1. Switch the ignition on and off again.
2. With icy conditions make sure that blades are not frozen to the windshield.
3. Press the wiper lever up beyond the point of resistance and hold it for approx. 3 seconds, until the wiper remains in a nearly vertical position.

After the wipers are folded back down, the wiper system must be reactivated.

1. Switch on the ignition.
2. Push wiper lever down. Wipers move to their resting position and are ready again for operation.

Washer fluid**Information****WARNING**

Some antifreeze agents can contain harmful substances and are flammable. There is risk of fire and risk of injuries. Observe the instructions on the containers. Keep antifreeze away from ignition sources. Do not refill operating materials into different bottles. Store operating materials out of reach of children.

United States: The washer fluid mixture ratio is regulated by the U.S. EPA and many individual states; do not exceed the allowable washer fluid dilution ratio limits that apply. Follow the usage instructions on the washer fluid container.

Use of BMW's Windshield Washer Concentrate or the equivalent is recommended. ◀

**WARNING**

Improperly executed work under the hood can damage components and lead to a safety risk. There is risk of accidents or risk of property damage. Have work under the hood be executed by a dealer's service center or another qualified service center or repair shop. ◀

Washer fluid reservoir

All washer nozzles are supplied from one reservoir in the engine compartment.

Fill with a mixture of windshield washer concentrate and tap water and – if required – with a washer antifreeze, according to the manufacturer's recommendations.

Mix the washer fluid before adding to find the right mixture.

Do not add windshield washer concentrate and antifreeze undiluted and do not fill with pure water; this could damage the wiper system.

Do not mix window washer concentrates of different manufacturers because they can clog the windshield washer nozzles.

Recommended minimum fill quantity:
0.2 US gal/1 liter.

Steptronic transmission

Selector lever positions

D Drive

Selector lever position for normal vehicle operation. All gears for forward travel are activated automatically.

R is Reverse

Select only when the vehicle is stationary.

N Neutral:

The vehicle may roll. Use in automatic car washes, e.g.

When the ignition is switched off, refer to page 67, selector lever position P is engaged automatically.

P Park

Select only when the vehicle is stationary. The drive wheels are blocked.

P is engaged automatically:

- ▷ After the engine is switched off when the vehicle is in radio-ready state, refer to page 67, or when the ignition is switched off, refer to page 67, and when selector lever position R or D is set.
- ▷ With the ignition off, if selector lever position N is set.

- ▷ If the driver's safety belt is released, the driver's door is opened, and the brake pedal is not pressed while the vehicle is stationary and selector lever position D or R is set.

Before exiting the vehicle, make sure that selector lever position P is set. Otherwise, the vehicle may begin to move.

Kickdown

Kickdown is used to achieve maximum driving performance. Step on the accelerator pedal beyond the resistance point at the full throttle position.

Engaging selector lever positions

General information

To prevent the vehicle from creeping after you select a gear, maintain pressure on the brake pedal until you are ready to start.

- ▷ It is not possible to shift out of selector lever position P until the engine is running and the brake is applied.
- ▷ With the vehicle is stationary, press on the brake pedal before shifting out of selector lever position P or N; otherwise, the shift command will not be executed: shift lock.

A block prevents the inadvertent switching to selector lever position P or R or the inadvertent change from selector lever position P.

Engaging selector lever position D, N, R



Briefly push the selector lever in the desired direction, beyond a resistance point if needed. After releasing the selector lever, it returns to its center position.

Canceling the lock

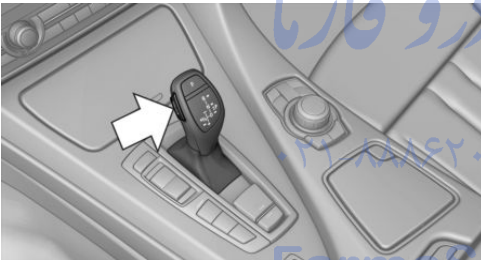

Press unlock button, arrow.

Engage selector lever position P



Press P button, arrow.

Sport program and manual mode

Activating the sport program



Press the selector lever to the left out of selector lever position D.

The engaged gear is displayed in the instrument cluster, e.g., S1.

The sport program of the transmission is activated.

Activating the M/S manual mode

1. Press the selector lever to the left out of selector lever position D.
2. Push the selector lever forward or pull it backward.

Manual mode becomes active and the gear is changed.

The engaged gear is displayed in the instrument cluster, e.g., M1.

If the situation requires, the Steptronic transmission continues to shift automatically.

Example: once maximum engine speed is attained, M/S manual mode is automatically upshifted as needed.

Switching to manual mode

- ▶ To shift down: press the selector lever forward.
- ▶ To shift up: pull the selector lever rearwards.

Gears will only be shifted at appropriate engine and road speeds, for example downshifting is not possible if the engine speed is too high.

The selected gear is briefly displayed in the instrument cluster, followed by the currently selected gear.

Steptronic Sport transmission: prevent automatic upshifting in M/S manual mode

The Steptronic Sport transmission does not automatically upshift in M/S manual mode once the maximum speed is reached, if one of the following conditions is met:

- ▷ DSC deactivated.
- ▷ TRACTION activated.
- ▷ SPORT+ activated.

In addition, there is no downshift for kickdown.

With the respective transmission version, the lowest possible gear can be selected by simultaneously operating the kickdown and the left shift paddle. However, this effect is not produced via the shift paddles when switching briefly from selector lever position D to manual mode.

Ending the sport program/manual mode

Push the selector lever to the right.

D is displayed in the instrument cluster.

Shift paddles



The shift paddles on the steering wheel allow you to shift gears quickly while keeping both hands on the steering wheel.

- ▷ Shift up: briefly pull right shift paddle.
- ▷ Shift down: briefly pull left shift paddle.

- ▷ With the respective transmission version, the lowest possible gear can be selected by pulling and holding the left shift paddle.

Gears will only be shifted at appropriate engine and road speeds, for example downshifting is not possible if the engine speed is too high.

The selected gear is briefly displayed in the instrument cluster, followed by the current gear.

If the shift paddles on the steering wheel are used to shift gears in automatic mode, the transmission temporarily switches to manual mode.

If the selector lever is still in selector lever position D with the respective transmission version, it is possible to switch back into the automatic mode:

- ▷ Pull and hold right shift paddle.
or
- ▷ In addition to the briefly pulled right shift paddle, briefly pull the left shift paddle.

In the manual mode, after conservative driving for a certain amount of time or if there has been no acceleration or shifting of the shift paddles within a certain amount of time, the transmission switches back to automatic mode.

Displays in the instrument cluster

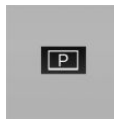

The selector lever position is displayed, e.g.: P.

Electronic unlocking of the transmission lock

General information

Electronically unlock the transmission lock to maneuver vehicle from the danger area.

Unlocking is possible, if the started can spin the engine.

Engaging selector lever position N

1. Depress the brake pedal.
2. Press the Start/Stop button. The starter must audibly start.
3. Press and hold the selector lever into position N.
A corresponding Check Control message is displayed.
4. Press the selector lever again into position N within approx. 6 seconds.
Selector lever position N is displayed in the instrument cluster.
5. Release brake, as soon as the starter stops.
6. Maneuver the vehicle from the danger area and secure it against moving on its own.

Steptronic Sport transmission: Launch Control

The concept

Launch Control enables optimum acceleration on surfaces with good traction.

General information

The use of Launch Control causes premature component wear since this function represents a very heavy load for the vehicle.

Do not use Launch Control during the break-in, refer to page 188, period.

To increase vehicle stability, activate DSC again as soon as possible.

An experienced driver may be able to achieve better acceleration values in DSC OFF mode.

Requirements

Launch Control is available when the engine is warmed up, that is, after uninterrupted driving of at least 6 miles/10 km.

To start with Launch Control do not steer the steering wheel.

Start with launch control

While the engine is running:

1.  Press button or select Sport+ with the Driving Dynamics Control.
TRACTION is displayed in the instrument cluster and the indicator lamp for DSC OFF lights up.
2. Engage selector lever position S.
3. With the left foot, forcefully press down on the brake.
4. Press and hold down the accelerator pedal beyond the resistance point at the full throttle position, kickdown.
♦ A flag symbol is displayed in the instrument cluster.
5. The starting engine speed adjusts. Within 3 seconds, release the brake.

Before using Launch Control, allow the transmission to cool down for approx. 5 minutes.

Launch Control adjusts to the surrounding conditions, e.g., wet pavement, when used again.

Displays

Vehicle features and options

This chapter describes all standard, country-specific and optional features offered with the series. It also describes features that are not necessarily available in your car, e. g., due to

the selected options or country versions. This also applies to safety-related functions and systems. The respectively applicable country provisions must be observed when using the respective features and systems.

Overview, instrument cluster

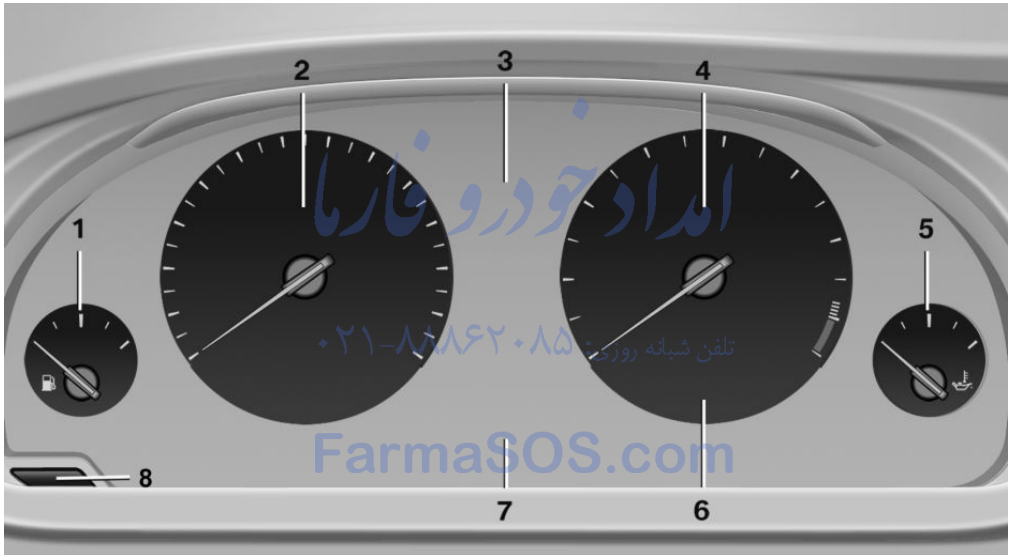

- | | |
|---------------------------------|---|
| 1 Fuel gauge 90 | 5 Engine oil temperature 90 |
| 2 Speedometer | 6 Current fuel consumption |
| 3 Messages, e.g. Check Control | 7 Electronic displays 82 |
| 4 Tachometer 90 | 8 Reset miles 90 |

Electronic displays

- ▷ Selection lists, refer to page [94](#).
- ▷ External temperature, refer to page [90](#).
- ▷ Auto Start/Stop function, refer to page [69](#).
- ▷ On-board computer, refer to page [95](#).
- ▷ Date, refer to page [91](#).
- ▷ Energy recovery, refer to page [92](#).
- ▷ Transmission display, refer to page [80](#).
- ▷ Miles/trip miles, refer to page [90](#).

- ▷ Messages, e.g. Check Control, refer to page 86.
- ▷ Current fuel consumption, refer to page 91.
- ▷ Navigation display, see User's manual for Navigation, Entertainment and Communication.
- ▷ Range, refer to page 91.
- ▷ Status, Driving Dynamics Control, refer to page 139.
- ▷ Service requirements, refer to page 92.
- ▷ Speed limit detection, refer to page 93.
- ▷ Time, refer to page 91.

Multifunctional instrument display

The concept

The instrument display is a variable display. In the event of a program change, the display rendition adapts to the respective program through the Driving Dynamics Control. The change of the display type can be deactivated via iDrive.

Some of the displays in the instrument display may differ from the way they are shown in this Owner's Manual.

Overview

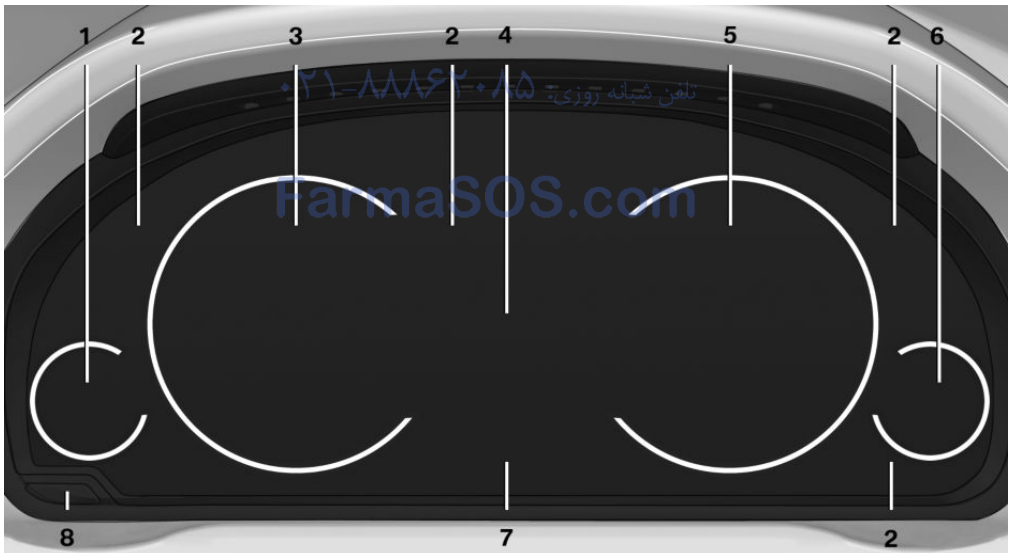

- | | |
|-------------------------------|-----------------------------|
| 1 Fuel gauge 90 | 5 Tachometer 90 |
| 2 Indicator/warning lights 86 | Selection lists 94 |
| 3 Speedometer | ECO PRO displays 196 |
| 4 Variable displays | 6 Engine oil temperature 90 |

7 On-board computer 95

Switching the change of display on and off

You can set whether the instrument display automatically changes to the ECO PRO or SPORT in the display when you switch driving modes.

On the Control Display:

1. "Settings"
2. "Instrument cluster"
3. "ECO PRO Info"

ECO PRO displays



- 1 Speedometer
- 2 Variable displays: ECO PRO Tips, Deceleration assistant instructions, Driver assist system displays
- 3 Efficiency display 196
- 4 Transmission display
- 5
 - ▶ Blue: bonus range
 - ▶ Gray: range

8 Reset miles 90

Or "Driving mode view"

With Professional Navigation System: switching zoom function on/off

You can program whether the current speed is to appear enlarged in the speedometer.

On the Control Display:

1. "Settings"
2. "Instrument cluster"
3. "Magnifier function"

In the ECO PRO program the instrument displays switch to the ECO PRO displays. These

displays support a driving style that saves on fuel consumption with more prominent repre-

sensation of the efficiency display and various ECO PRO tips.

Sport displays

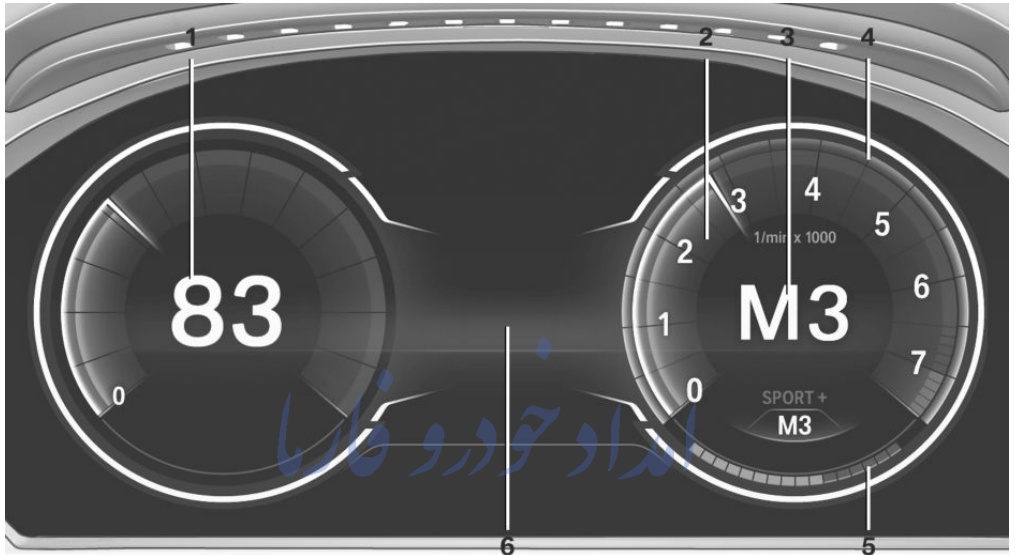

- | | |
|--|--|
| <ul style="list-style-type: none"> 1 Speedometer 2 Tachometer 90 3 Transmission display | <ul style="list-style-type: none"> 4 Shift lights, when respectively equipped 5 Performance display 6 Variable displays |
|--|--|

In the Sport and Sport+ programs the instrument display switches to the sport displays. These displays support a sporty driving style with more prominent representation of the tachometer, the transmission displays, and the vehicle speed.

Shift lights in the instrument display

The concept

The shift point indicator indicates the optimum shift moment in the tachometer. Thus, with a sporty driving style, the best possible vehicle acceleration is achieved.

General information

Steptronic Sport transmission: shift lights are shown, when the SPORT+ driving program is activated.

Switching on shift lights

Steptronic Sport transmission:

1. Select SPORT+ using the Driving Dynamics Control.
2. Activate the M/S manual mode of the transmission.

Display in the instrument display



- ▷ Current engine speed is displayed in the tachometer.
- ▷ Arrow 1: successive yellow illuminated fields indicate an increase in the speed.
- ▷ Arrow 2: successive orange illuminated fields indicate the upcoming shift moment.
- ▷ Arrow 3: fields are illuminated in red. Do not wait any further to shift.

When the maximum possible speed is reached, the entire display flashes. When the maximum speed is exceeded, the supply of fuel is interrupted in order to protect the engine.

Check Control

The concept

The Check Control system monitors functions in the vehicle and notifies you of malfunctions in the monitored systems.

A Check Control message is displayed as a combination of indicator or warning lights and text messages in the instrument cluster and in the Head-up Display.

In addition, an acoustic signal may sound and a text message may appear on the Control Display.

Indicator/warning lights

General information

The indicator and warning lights in the instrument cluster can light up in a variety of combinations and colors.

Several of the lights are checked for proper functioning and light up temporarily when the engine is started or the ignition is switched on.

Red lights

Safety belt reminder



Safety belt on the driver's side is not buckled. For some country-specific models: passenger belt is not worn or objects are detected on the front passenger seat.

Flashing or illuminated: safety belt on the driver or passenger side is not buckled. The safety belt reminder can also be activated if objects are placed on the front passenger seat.

Make sure that the safety belts are positioned correctly.

Airbag system



Airbag system and belt tensioner are not working.

Have the vehicle checked immediately by a dealer's service center or another qualified service center or repair shop.

Parking brake



The parking brake is set.

For additional information, refer to Release parking brake, refer to page 71.

Brake system





Braking system disrupted. Continue to drive moderately.

Have the vehicle checked immediately by a dealer's service center or another qualified service center or repair shop.

Front-end collision warning



Illuminated: advance warning is issued, e.g., when there is the impending danger of a collision or the distance to the vehicle ahead is too small.

Increase distance.

Flashing: acute warning of the imminent danger of a collision when the vehicle approaches another vehicle at a relatively high differential speed.

Intervention by braking or make an evasive maneuver.

Pedestrian warning



Symbol in the instrument cluster.

If a collision with a person detected in this way is imminent, the symbol lights up and a signal sounds.



Symbol in the instrument display.

If a collision with a person detected in this way is imminent, the symbol lights up and a signal sounds.

Orange lights

Active Cruise Control



The number bars shows the selected distance from the vehicle driving ahead.

For additional information, refer to Active Cruise Control with Stop & Go function, ACC, refer to page 142.

Vehicle detection, Active Cruise Control



Illuminated: vehicle driving ahead detected.

Flashing: the conditions are not adequate for operating the system.

The system was deactivated but applies the brakes until you actively resume control by pressing on the brake pedal or accelerator pedal.

Yellow lights

Anti-lock Braking System ABS



Avoid sudden braking as much as possible. Braking force boost may not be working. Stop cautiously. Take into account the longer brake distance. Have checked immediately by a dealer's service center or another qualified



service center or repair shop.

DSC Dynamic Stability Control



Flashing: DSC controls the drive and braking forces. The vehicle is stabilized. Reduce speed and adapt driving style to the driving circumstances.

Illuminated: DSC failed. Have system checked immediately by a dealer's service center or another qualified service center or repair shop.

For additional information, refer to Dynamic Stability Control DSC, refer to page 135.

DSC Dynamic Stability Control is deactivated or DTC Dynamic Traction Control is activated



Dynamic Stability Control DSC is switched off or Dynamic Traction Control DTC is switched on.

For additional information, refer to Dynamic Stability Control DSC, refer to page 135, and

Dynamic Traction Control DTC, refer to page 136.

Flat Tire Monitor FTM



The Flat Tire Monitor signals a loss of tire inflation pressure in a tire.

Reduce your speed and stop cautiously. Avoid sudden braking and steering maneuvers.

For more information, see Flat Tire Monitor, refer to page 113.

Tire Pressure Monitor TPM



Illuminated: the Tire Pressure Monitor signals a loss of tire inflation pressure in a tire.

Reduce your speed and stop cautiously. Avoid sudden braking and steering maneuvers.

Flashing and then continuously illuminated: no flat tire or loss of tire inflation pressure can be detected.

- ▶ Interference through systems or devices with the same radio frequency: After leaving the area of the interference, the system automatically becomes active again.
- ▶ TPM could not conclude the reset: perform the reset of the system again.
- ▶ A wheel without TPM electronics is mounted: Have it checked by a dealer's service center or another qualified service center or repair shop as needed.
- ▶ Malfunction: Have system checked immediately by a dealer's service center or another qualified service center or repair shop.

For more information, see Tire Pressure Monitor, refer to page 109.

Steering system



Steering system in some cases not working.

Have steering system checked immediately by a dealer's service center or another qualified service center or repair shop.

Engine functions



Have vehicle checked immediately by a dealer's service center or another qualified service center or repair shop.

For additional information, refer to On-board Diagnostics socket, refer to page 229.

Lane departure warning



System is switched on and under certain circumstances warns if a detected lane is left without flashing beforehand.

For additional information, refer to Lane departure warning, refer to page 128.

Green lights

Turn signal



Turn signal switched on.

Unusually rapid flashing of the indicator lamp indicates that a turn signal bulb has failed.

For additional information, refer to Turn signal, refer to page 74.

Parking lights, headlight control



Parking lights or headlights are activated.

For additional information, refer to Parking lights/low beams, headlight control, refer to page 101.

Front fog lights



Front fog lights are activated.

For additional information, refer to Front fog lights, refer to page 104.

High-beam Assistant



High-beam Assistant is switched on. High beams are activated and off automatically as a function of the traffic situation.

For additional information, refer to High-beam Assistant, refer to page 103.

Cruise control



The system is switched on. It maintains the speed that was set using the control elements on the steering wheel.

Automatic Hold



Function is activated. The vehicle is automatically held in place when it is stationary.

For more information, see Automatic Hold, refer to page 72.

Blue lights

High beams



High beams are activated. For additional information, refer to High beams, refer to page 75.

General lamps

Check Control



At least one Check Control message is displayed or is stored.

Text messages

Text messages in combination with a symbol in the instrument cluster explain a Check Control message and the meaning of the indicator and warning lights.

Supplementary text messages

Additional information, such as on the cause of an error or the required action, can be called up via Check Control.

With urgent messages the added text will be automatically displayed on the Control Display.

Symbols

Depending on the Check Control message, the following functions can be selected.

- ▷ "Owner's Manual"
Display additional information about the Check Control message in the Integrated Owner's Manual.
- ▷ "Service request"
Contact a dealer's service center or another qualified service center or repair shop.
- ▷ "Roadside Assistance"
Contact Roadside Assistance.

Hiding Check Control messages

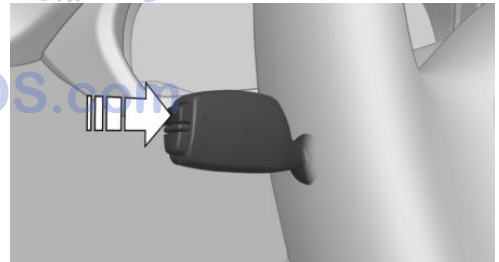

Press and hold PC button on blinker lever.

- ▷ Some Check Control messages are displayed continuously and are not cleared until the malfunction is eliminated. If several malfunctions occur at once, the messages are displayed consecutively.
These messages can be faded for approx. 8 seconds. After this time, they are displayed again automatically.

- ▶ Other Check Control messages are faded automatically after approx. 20 seconds. They are stored and can be displayed again later.

Displaying stored Check Control messages

On the Control Display:

1. "Vehicle info"
2. "Vehicle status"
3.  "Check Control"
4. Select the text message.

Messages after trip completion

Special messages displayed while driving are displayed again after the ignition is switched off.

Fuel gauge



Vehicle tilt position may cause the display to vary.

Depending on the equipment version, the arrow beside the fuel pump symbol shows which side of the vehicle the fuel filler flap is on.

Hints on refueling, refer to page 204.

Tachometer

Always avoid engine speeds in the red warning field. In this range, the fuel supply is interrupted to protect the engine.

Engine oil temperature



- ▶ Cold engine: the pointer is at the low temperature end. Drive at moderate engine and vehicle speeds.

- ▶ Normal operating temperature: the pointer is in the middle or in the left half of the temperature display.
- ▶ Hot engine: the pointer is at the high end of the temperature range. A Check Control message is also displayed.

Coolant temperature

If the coolant along with the engine becomes too hot, a Check Control message is displayed.

Check the coolant level, refer to page 226.

Odometer and trip odometer

Display

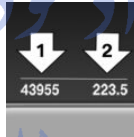

- ▶ Odometer, arrow 1.
- ▶ Trip odometer, arrow 2.

Show/reset kilometers



Press the knob.

- ▶ When the ignition is switched off, the time, the external temperature and the odometer are displayed.
- ▶ When the ignition is switched on, the trip odometer is reset.

External temperature

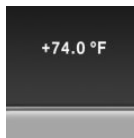

If the indicator drops to +37 °F/+3 °C or lower, a signal sounds.

A Check Control message is displayed.

There is an increased risk of ice on roads.

**WARNING**

Even at temperatures above +37 °F/+3 °C there can be a danger of icy roads, e.g. on bridges or shady sections of road. There is risk of an accident. Adjust your driving style to the weather conditions at low temperatures. ◀

Time

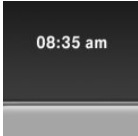

The time is displayed at the bottom of the instrument cluster.

Setting the time and time format, refer to page 97.

Date

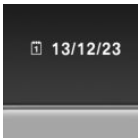

The date is displayed in the onboard computer.

Setting the date and date format, refer to page 98.

Range

Display

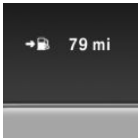

With a low remaining range:

- ▶ A Check Control message is displayed briefly.
 - ▶ The remaining range is shown on the onboard computer.
- ▶ With a dynamic driving style, e.g. taking curves aggressively, the engine function is not always ensured.

The Check Control message appears continuously below a range of approx. 30 miles/50 km.

**CAUTION**

With a range of less than 30 miles/50 km it is possible that the engine will no longer have sufficient fuel. Engine functions are no longer

ensured. There is risk of property damage. Refuel promptly. ◀

Displaying the cruising range

Depending on your vehicle's optional features, the range can also be displayed as bar in the instrument cluster.

1. "Settings"
2. "Instrument cluster"
3. "Additional indicators"

With navigation system: range with destination guidance active

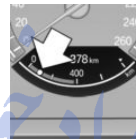

If respective equipment is fitted and destination guidance is active, the remaining range is displayed when the destination is reached.

Current fuel consumption

Display



Depending on your vehicle's optional features, the current fuel consumption can be displayed in the instrument cluster. Check whether you are currently driving in an efficient and environmentally-friendly manner.

Displaying the current fuel consumption

1. "Settings"
2. "Instrument cluster"
3. "Additional indicators"

The bar display for the current fuel consumption is displayed in the instrument cluster.

Energy recovery

Display

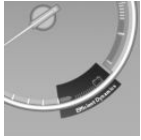

The kinetic energy of the vehicle is converted to electrical energy while coasting. The vehicle battery is partially charged and fuel consumption can be reduced.

Service requirements

The concept

After the ignition is turned on the instrument cluster briefly displays available driving distance or time to the next scheduled maintenance.

A service advisor can read out the current service requirements from your remote control.



Display

Detailed information on service requirements

More information on the scope of service required can be displayed on the Control Display.

1. "Vehicle info"
2. "Vehicle status"
3.  "Service required"
Required maintenance procedures and legally mandated inspections are displayed.
4. Select an entry to call up detailed information.

Symbols

Symbols	Description
	No service is currently required.
	The deadline for scheduled maintenance or a legally mandated inspection is approaching.
	The service deadline has already passed.

Entering appointment dates

Enter the dates for the required inspections.

Make sure that the vehicle's date and time are set correctly.

On the Control Display:

1. "Vehicle info"
2. "Vehicle status"
3.  "Service required"
4. "§ Vehicle inspection"
5. "Date:"
6. Adjust the settings.
7. Confirm.

The entered date is stored.

Automatic Service Request

Data regarding the service status or legally mandated vehicle inspections are automatically transmitted to your dealer's service center before a service due date.

You can check when your dealer's service center was notified.

On the Control Display:

1. "Vehicle info"
2. "Vehicle status"
3. Open "Options".
4. "Last Service Request"

Gear shift indicator

The concept

The system recommends the most fuel efficient gear for the current driving situation.



General information

Depending on the vehicle's features and country version of the vehicle, the gear shift indicator is active in the manual mode of the Step-tronic transmission.

Suggestions to shift gear up or down are displayed in the instrument cluster.

On vehicles without a gear shift indicator, the engaged gear is displayed.

Displays

Example	Description
	Fuel efficient gear is set.
	Shift into fuel efficient gear.

Speed limit detection

The concept

Speed limit detection

Speed limit detection shows the current maximum permitted speed in the instrument cluster. The camera in the area of the interior rearview mirror detects traffic signs at the edge of the road as well as variable overhead sign posts. Traffic signs with extra symbols for wet road conditions, etc. are also detected and compared with the vehicle's onboard data, such as for the rain sensor, and will be displayed depending on the situation. The system takes into account the information stored in

the navigation system and also displays speed limits present on routes without signs.

Information



WARNING

The system does not relieve from the personal responsibility to correctly assess visibility and traffic situation. There is risk of an accident. Adjust the driving style to the traffic conditions. Watch traffic closely and actively interfere in the respective situations. ◀

Overview

Camera

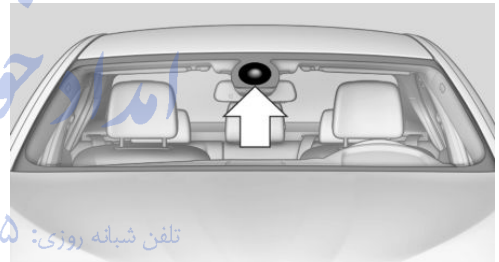

The camera is installed near the interior rearview mirror.

Keep the windshield in the area behind the interior rearview mirror clean and clear.

Switching on/off

On the Control Display:

1. "Settings"
2. "Instrument cluster"
3. "Speed limit information"

If speed limit detection is switched on, it can be displayed on the info display in the instrument cluster via the on-board computer.

Display

The following is displayed in the instrument cluster:

Speed limit detection

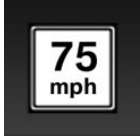

Current speed limit.



Speed limit detection is not available.

Speed limit detection can also be displayed in the Head-up Display.

System limits

The system may not be fully functional and may provide incorrect information in the following situations:

- ▷ In heavy fog, rain or snowfall.
- ▷ When signs are concealed by objects.
- ▷ When driving very close to the vehicle in front of you.
- ▷ When driving toward bright lights.
- ▷ When the windshield behind the interior rearview mirror is fogged over, dirty or covered by a sticker, etc.
- ▷ In the event of incorrect detection by the camera.
- ▷ If the speed limits stored in the navigation system are incorrect.
- ▷ In areas not covered by the navigation system.
- ▷ When roads differ from the navigation, such as due to changes in road routing.
- ▷ When passing buses or trucks with a speed sticker.
- ▷ If the traffic signs are non-conforming.
- ▷ During calibration of the camera immediately after vehicle delivery.

Selection lists in the instrument cluster

The concept

Depending on your vehicle's optional features, the following can be displayed or operated using the buttons and the thumbwheel on the steering wheel as well as the displays in the instrument cluster and the Head-up Display:

- ▷ Current audio source.
- ▷ Redial phone feature.
- ▷ Turn on voice activation system.

Display

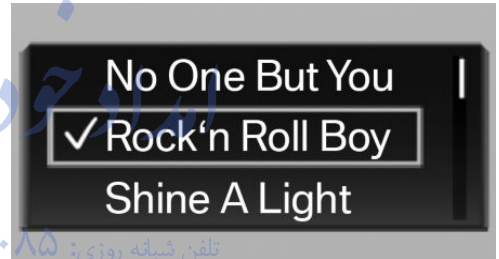

Depending on your vehicle's optional features, the list in the instrument cluster can differ from the illustration shown.

Activating a list and adjusting the setting

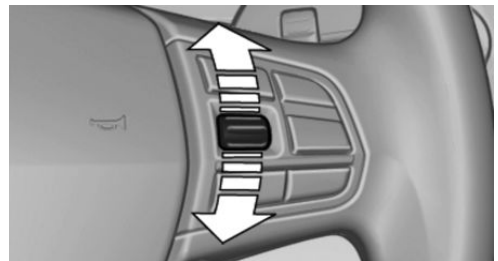

On the right side of the steering wheel, turn the thumbwheel to activate the corresponding list.

Using the thumbwheel, select the desired setting and confirm it by pushing the thumbwheel.

On-board computer

Indication in the info display

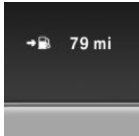

The information from the on-board computer is shown in the info display in the instrument cluster.

Calling up information on the info display

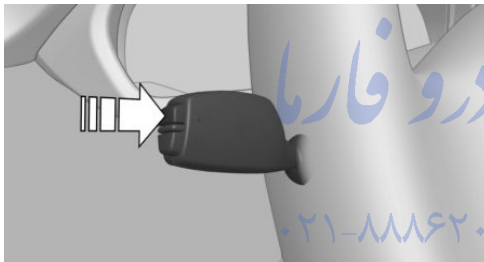

Press and hold PC button on blinker lever.

Information is displayed in the info display of the instrument cluster.

Information at a glance

Repeatedly pressing the button on the turn signal lever calls up the following information in the info display:

- ▷ Range.
- ▷ Average consumption, fuel.
- ▷ Average consumption, fuel.
- ▷ Average speed.
- ▷ Date.
- ▷ Speed limit detection.
- ▷ Time of arrival.

When destination guidance is activated in the navigation system.

- ▷ Distance to destination.

When destination guidance is activated in the navigation system.

- ▷ Compass display in the navigation system.

Adjusting the info display

Depending on the vehicle equipment version, you can select what information from the on-board computer is to be displayed on the info display of the instrument cluster.

On the Control Display:

1. "Settings"
2. "Instrument cluster"
3. Select the desired displays.

Information in detail

Range

Displays the estimated cruising range available with the remaining fuel.

It is calculated based on your driving style over the last 20 miles/30 km.

Average fuel consumption

The average fuel consumption is calculated for the period while the engine is running.

The average fuel consumption is calculated for the distance traveled since the last reset by the on-board computer.

Average speed

Periods in which the vehicle is parked with the engine manually stopped are not included in the calculation of the average speed.

Resetting average values

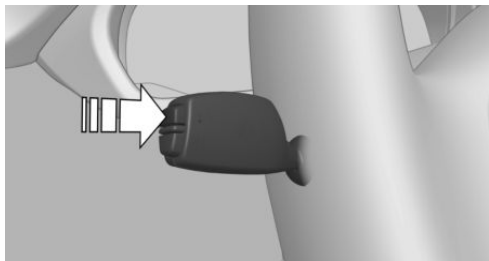

Press and hold PC button on blinker lever.

Distance to destination

The distance remaining to the destination is displayed if a destination is entered in the navigation system before the trip is started.

The distance to the destination is adopted automatically.

Time of arrival

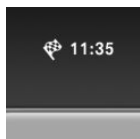

The estimated time of arrival is displayed if a destination is entered in the navigation system before the trip is started.

The time must be correctly set.

Speed limit detection

Description of the speed limit detection, refer to page 93, function.

Compass

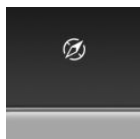

With a navigation system: compass display for the driving direction.

Trip on-board computer

The vehicle features two types of on-board computers.

- ▷ "Onboard info": the values can be reset as often as necessary.

- ▷ "Trip computer": the values provide an overview of the current trip.

Resetting the trip on-board computer

On the Control Display:

1. "Vehicle info"
2. "Trip computer"
3. "Reset": all values are reset.

"Automatically reset": all values are reset approx. 4 hours after the vehicle came to a standstill.

Display on the Control Display

Display the on-board computer or trip on-board computer on the Control Display.

1. "Vehicle info"
2. "Onboard info" or "Trip computer"

Resetting the fuel consumption or speed

On the Control Display:

1. "Vehicle info"
2. "Onboard info"
3. "Consumpt." or "Speed"
4. "Yes"

Sport displays

The concept

On the Control Display, the current values for performance and torque can be displayed if the vehicle is appropriately equipped.

Displaying sport displays on the Control Display

1. "Vehicle info"
2. "Sport displays"

Speed warning

The concept

Displays a speed, when reached, should cause a warning to be issued.

The warning is repeated if the vehicle speed drops below the set speed once by at least 3 mph/5 km/h.

Displaying, setting or changing the speed warning

On the Control Display:

1. "Settings"
2. "Speed"
3. "Warning at:"
4. Turn the controller until the desired speed is displayed.
5. Press the controller.

Speed warning is stored.

Activating/deactivating the speed warning

On the Control Display:

1. "Settings"
2. "Speed"
3. "Warning"
4. Press the controller.

Setting your current speed as the speed warning

On the Control Display:

1. "Settings"
2. "Speed"
3. "Select current speed"
4. Press the controller.

The current vehicle speed is stored as the speed warning.

Settings on the Control Display

Time

Setting the time zone

1. "Settings"
2. "Time/Date"
3. "Time zone:"
4. Select the desired time zone.

The time zone is stored.

Setting the time

1. "Settings"
2. "Time/Date"
3. "Time:"
4. Turn the controller until the desired hours are displayed.
5. Press the controller.
6. Turn the controller until the desired minutes are displayed.
7. Press the controller.

The time is stored.

Setting the time format

1. "Settings"
2. "Time/Date"
3. "Format:"
4. Select the desired format.

The time format is stored.

Automatic time setting

Depending on your vehicle's optional features, the time, date and, if needed, the time zone are updated automatically.

1. "Settings"
2. "Time/Date"
3. "Auto time set"

Date

Setting the date

1. "Settings"
2. "Time/Date"
3. "Date:"
4. Turn the controller until the desired day is displayed.
5. Press the controller.
6. Make the necessary settings for the month and year.

The date is stored.

Setting the date format

1. "Settings"
2. "Time/Date"
3. "Format:"
4. Select the desired format.

The date format is stored.

Language

Setting the language

To set the language on the Control Display:

1. "Settings"
2. "Language/Units"
3. "Language:"
4. Select the desired language.

Settings are stored for the profile currently used.

Setting the voice dialog

Voice dialog for the voice activation system, refer to page 27.

Units of measurement

Setting the units of measurement

To set the units for fuel consumption, route/distance and temperature:

1. "Settings"
2. "Language/Units"
3. Select the desired menu item.
4. Select the desired unit.

Settings are stored for the profile currently used.

Brightness

Setting the brightness

To set the brightness of the Control Display:

1. "Settings"
2. "Control display"
3. "Brightness"
4. Turn the controller until the desired brightness is set.
5. Press the controller.

Settings are stored for the profile currently used.

Depending on the light conditions, the brightness settings may not be clearly visible.

Head-up Display

Overview

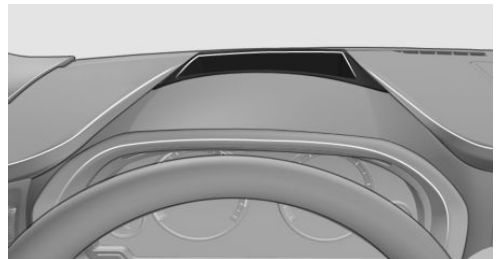

The concept

This system projects important information into the driver's field of vision, e. g., the speed.

The driver can get information without averting his or her eyes from the road.

Information

Follow the instructions for cleaning the Head-up Display, refer to page 246.

Display visibility

The visibility of the displays in the Head-up Display is influenced by the following factors:

- ▷ Certain sitting positions.
- ▷ Objects on the cover of the Head-up Display.
- ▷ Sunglasses with certain polarization filters.
- ▷ Wet roads.
- ▷ Unfavorable light conditions.

If the image is distorted, have the basic settings checked by a dealer's service center or another qualified service center or repair shop.

Switching on/off

1. "Settings"
2. "Head-Up Display"
3. "Head-Up Display"

Display

Overview

The following information is displayed on the Head-up Display:

- ▷ Speed.
- ▷ Navigation system.
- ▷ Check Control messages.
- ▷ Selection list from the instrument cluster.
- ▷ Driver assistance systems.

Some of this information is only displayed briefly as needed.

Selecting displays in the Head-up Display

On the Control Display:

1. "Settings"
2. "Head-Up Display"
3. "Displayed information"
4. Select the desired displays in the Head-up Display.

Settings are stored for the profile currently used.

Setting the brightness

The brightness is automatically adjusted to the ambient brightness.

The basic setting can be adjusted manually.

On the Control Display:

1. "Settings"
2. "Head-Up Display"
3. "Brightness"
4. Turn the controller until the desired brightness is set.
5. Press the controller.

When the low beams are activated, the brightness of the Head-up Display can be additionally influenced using the instrument lighting.

Settings are stored for the profile currently used.

Adjusting the height

On the Control Display:

1. "Settings"
2. "Head-Up Display"
3. "Height"
4. Turn the controller until the desired height is reached.
5. Press the controller.

Settings are stored for the profile currently used.

Setting the rotation

The screen of the Head-up Display can be rotated around its own axis.

On the Control Display:

1. "Settings"
2. "Head-Up Display"
3. "Rotation"
4. Turn the controller until the desired setting is selected.
5. Press the controller.

Settings are stored for the profile currently used.

Special windshield

The windshield is part of the system.

The shape of the windshield makes it possible to display a precise image.

A film in the windshield prevents double images from being displayed.

For this reason, it is strongly suggested to have the special windshield replaced by a dealer's service center or another qualified service center or repair shop.

امداد خودرو فارما
تلفن شبانه روزی: ۰۸۵ ۲۰۸۶۲ ۰۸۵
FarmaSOS.com

Lights

Vehicle features and options

This chapter describes all standard, country-specific and optional features offered with the series. It also describes features that are not necessarily available in your car, e. g., due to the selected options or country versions. This also applies to safety-related functions and systems. The respectively applicable country provisions must be observed when using the respective features and systems.



Overview



Switches in the vehicle



The light switch elements is located next to the steering wheel.

Light functions

Symbol	Function
	Front fog lights
	Automatic headlight control Adaptive Light Control
	Lights off Daytime running lights

Symbol	Function
	Parking lights
	Low beams
	Instrument lighting

Parking lights, cornering lights and roadside parking lights

General information

Position of switch: 0, , , 

If the driver door is opened with the ignition switched off, the exterior lighting is automatically switched off at these switch settings.

Parking lights

Position of switch: 

The vehicle is illuminated on all sides.

Do not use the parking lights for extended periods; otherwise, they might drain the battery and it would then be impossible to start the engine.

When parking, switch on the one-sided roadside parking lamp, refer to page 102.

Low beams

Position of switch: 

The low beams light up when the ignition is switched on.

Roadside parking lights

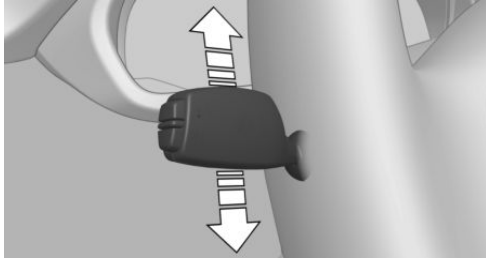

The vehicle can be illuminated on one side.

Switching on



With the ignition switched off, press the lever either up or down past the resistance point for approx. 2 seconds.

Switch off

Briefly press the lever to the resistance point in the opposite direction.

Welcome lights and headlight courtesy delay feature

Welcome lights

Depending on the equipment, when switching off the vehicle, switch position  or  .

The parking and interior lights light up briefly when the vehicle is unlocked and depending on the ambient brightness.

Activating/deactivating

On the Control Display:

1. "Settings"
2. "Lighting"
3. "Welcome lights"

Settings are stored for the profile currently used.

Headlight courtesy delay feature

The low beams stay lit for a short while if the headlight flasher is switched on after the radio-ready state is switched off.

Setting the duration

On the Control Display:

1. "Settings"
2. "Lighting"
3. "Pathway lighting:"
4. Set length of time.

Settings are stored for the profile currently used.

Automatic headlight control

The concept

The low beams are switched on and off automatically depending on the ambient brightness, e.g. in tunnels, in twilight or if there is precipitation.

General information

A blue sky with the sun low on the horizon can cause the lights to be switched on.

When emerging from a tunnel during the day, the low beams are not switched off immediately but instead only after approx. 2 minutes.

The low beams always stay on when the fog lights are activated.

Activating

Position of switch: 

The indicator lamp in the instrument cluster lights up when the low beams are switched on.

System limits

The automatic headlamp control cannot serve as a substitute for your personal judgment of lighting conditions.

E. g. the sensors are unable to detect fog or hazy weather. To avoid safety risks under these conditions, you should always switch on the lights manually.

Daytime running lights

Position of switch: 0, , 

The daytime running lights light up when the ignition is switched on. After the ignition is switched off, the parking lights light up in position .

Activating/deactivating

In some countries, daytime running lights are mandatory, so it may not be possible to deactivate the daytime running lights.

On the Control Display:

1. "Settings"
2. "Lighting"
3. "Daytime running lamps"

Settings are stored for the profile currently used.

Activating

Position of switch  with the ignition switched on.

To avoid blinding oncoming traffic, the Adaptive Light Control does not swivel to the driver's side when the vehicle is at a standstill.

The turning lights are automatically switched on depending on the steering angle or the use of turn signals.

When driving in reverse, the turning lights may be automatically switched on regardless of the steering angle.

Self-leveling headlights

The self-leveling headlights compensate for acceleration and braking operations in order not to blind the oncoming traffic and to achieve optimum illumination of the roadway.

Malfunction

A Check Control message is displayed.

Adaptive Light Control is malfunctioning or has failed. Have the system checked as soon as possible.

Adaptive Light Control High-beam Assistant

The concept

Adaptive Light Control is a variable headlight control system that enables dynamic illumination of the road surface.

Depending on the steering angle and other parameters, the light from the headlight follows the course of the road.



In tight curves, e.g., on mountainous roads or when turning, an additional, corner-illuminating lamp is switched on that lights up the inside of the curve when the vehicle is moving below a certain speed.

The concept

When the low beams are activated, this system automatically switches the high beams on and off or suppresses the light in the areas that blind oncoming traffic. The procedure is controlled by a camera on the front of the interior rearview mirror. The assistant ensures that the high beams are activated whenever the traffic situation allows. The driver can intervene at any time and switch the high beams on and off as usual. In the low speed range, the high beams are not switched on by the system.

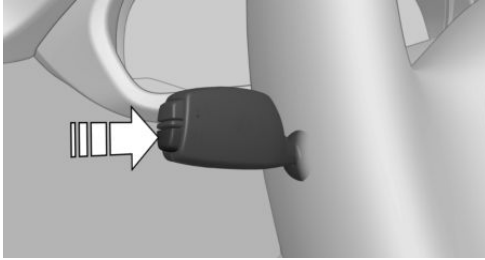
Activating



1. Depending on the equipment, turn the light switch into position  or  .
2. Press button on the turn signal lever, arrow.



The indicator lamp in the instrument cluster lights up.

When the low beams are on, the lights are automatically brightened or dimmed.

The system responds to light from oncoming traffic and traffic driving ahead of you, and to adequate illumination, e.g., in towns and cities.



The blue indicator lamp in the instrument cluster lights up when the system switches on the high beams. Depending on the version of the system in the vehicle, the high beams may not switch off for oncoming vehicles, but may only be dimmed in the areas that blind oncoming traffic. In this case, the blue indicator light will stay on.

Switching the high beams on and off manually

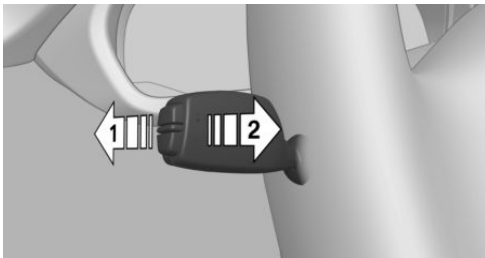

- ▷ High beams on, arrow 1.

- ▷ High beams off/headlight flasher, arrow 2.

The High-beam Assistant can be switched off when manually adjusting the light.

To reactivate the high-beam Assistant, press the button on the turn signal lever, refer to page 104.

System limits

The High-beam Assistant cannot serve as a substitute for the driver's personal judgment of when to use the high beams. In situations that require this, therefore switch off manually.

The system is not fully functional in situations such as the following, and driver intervention may be necessary:

- ▷ In very unfavorable weather conditions, such as fog or heavy precipitation.
- ▷ When detecting poorly-lit road users such as pedestrians, cyclists, horseback riders and wagons; when driving close to train or ship traffic; and at animal crossings.
- ▷ In tight curves, on hilltops or in depressions, in cross traffic or half-observed oncoming traffic on freeways.
- ▷ In poorly-lit towns and cities and in the presence of highly reflective signs.
- ▷ When the windshield behind the interior rearview mirror is fogged over, dirty or covered with stickers, etc.

Fog lights

Front fog lights

The low beams must be switched on.



Press button. The green indicator lamp lights up.

If the automatic headlight control, refer to page 102, is activated, the low beams will come on automatically when you switch on the front fog lights.

When the high beams or headlight flasher are activated, the front fog lights are not switched on.

Instrument lighting

Adjusting



The parking lights or low beams must be switched on to adjust the brightness.

Adjust the brightness with the thumbwheel.

Interior lights

General information

The interior lights, footwell lights, access lights and courtesy lights are controlled automatically.

Thumb wheel for the instrument lighting controls brightness of some of these features.

Overview



- 1 Interior lights
- 2 Reading lamp

Switching the interior lights on and off



Press button.

To switch off permanently: press the button for approx. 3 seconds.

Switch back on: press button.

Reading lights



Press button.

Reading lights are located at the front and rear next to the interior lights.

Ambient light

Depending on your optional features lighting can be adjusted for some lights in the interior.

Selecting color scheme

On the Control Display:

1. "Settings"
2. "Lighting"
3. "Lighting design"
4. Select desired setting.

To deactivate the ambient light: "Off".

Setting the brightness

On the Control Display:

1. "Settings"
2. "Lighting"
3. "Brightness:"
4. Adjust the brightness.

Safety

Vehicle features and options

This chapter describes all standard, country-specific and optional features offered with the series. It also describes features that are not necessarily available in your car, e. g., due to

the selected options or country versions. This also applies to safety-related functions and systems. The respectively applicable country provisions must be observed when using the respective features and systems.

Airbags

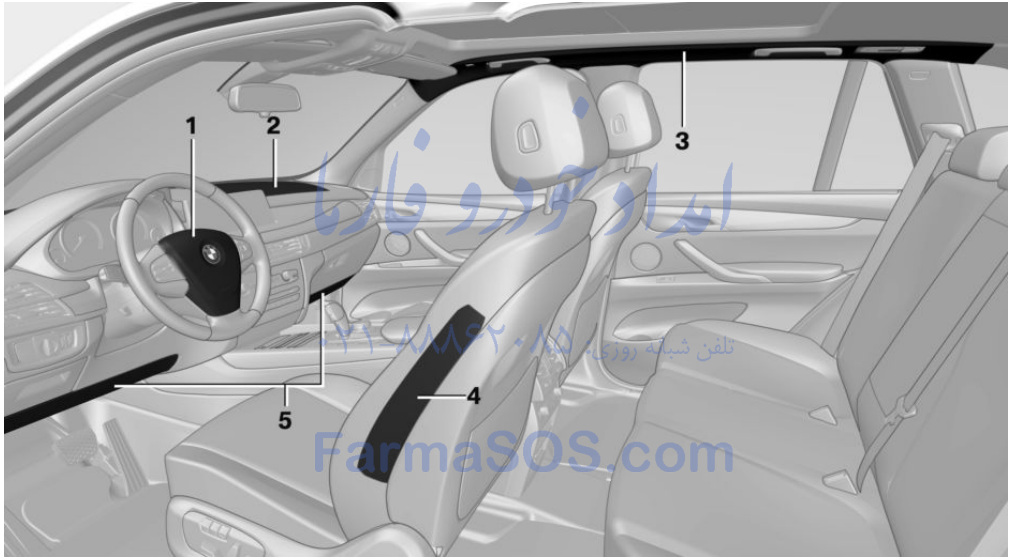

- | | |
|---------------------------------|---------------|
| 1 Front airbag, driver | 4 Side airbag |
| 2 Front airbag, front passenger | 5 Knee airbag |
| 3 Head airbag | |

Front airbags

Front airbags help protect the driver and front passenger by responding to frontal impacts in which safety belts alone would not provide adequate restraint.

Side airbag

In a lateral impact, the side airbag supports the side of the body in the chest and lap area.

Head airbag

In a lateral impact, the head airbag supports the head.

Ejection Mitigation

The head airbag system is designed as an ejection mitigation countermeasure to reduce the likelihood of ejections of vehicle occupants through side windows during rollovers or side impact events.

Knee airbag

The knee airbag supports the legs in a frontal impact.

Protective action

Airbags are not triggered in every impact situation, e.g., in less severe accidents or rear-end collisions.

Information for optimum effect of the airbags

WARNING

If the seat position is incorrect or the deployment area of the airbags is impacted, the airbag system cannot protect as intended or cause additional injuries due to triggering. There is risk of injuries or danger to life. Observe the Information for optimum protective effect of the airbag system. ◀

- ▷ Keep at a distance from the airbags.
- ▷ Make sure that occupants keep their heads away from the side airbag.
- ▷ Always grasp the steering wheel on the steering wheel rim. Hold your hands at the 3 o'clock and 9 o'clock positions, to keep the risk of injury to your hands or arms as low as possible when the airbag is triggered.
- ▷ Make sure that the front passenger is sitting correctly, i.e., keeps his or her feet and legs in the floor area.
- ▷ There should be no persons, animals or objects between an airbag and a person.
- ▷ Do not apply adhesive materials to the airbag cover panels, do not cover them or modify them in any way.

- ▷ Dashboard and windshield on the front passenger side must stay clear - do not attach adhesive labels or coverings and do not attach brackets or cables, e. g., for GPS devices or mobile phones.
- ▷ Do not use the cover of the front airbag on the front passenger side as a storage area.
- ▷ Do not place slip covers, seat cushions or other objects on the front passenger seat that are not specifically suited for seats with integrated side airbags.
- ▷ Do not hang pieces of clothing, such as jackets, over the backrests.
- ▷ Never modify either the individual components or the wiring in the airbag system. This also applies to steering wheel covers, the dashboard, and the seats.
- ▷ Do not remove the airbag system.

Even when you follow all instructions very closely, injury from contact with the airbags cannot be ruled out in certain situations.

The ignition and inflation noise may lead to short-term and, in most cases, temporary hearing impairment in sensitive individuals.

Warnings and information on the airbags are also found on the sun visors.

Functional readiness of the airbag system

Information

WARNING

Individual components can be hot after triggering of the airbag system. There is risk of injuries. Do not touch individual components. ◀

WARNING

Improperly executed work can lead to failure, malfunction or unintentional triggering of the airbag system. In the case of a malfunction, the airbag system could not trigger as intended in the event of an accident despite respective accident severity. There is risk of

injuries or danger to life. Have the airbag system checked, repaired, dismantled and scrapped by a dealer's service center or another qualified service center or repair shop. ◀

Correct function



When the ignition is switched on, the warning lamp in the instrument cluster lights up briefly and thereby indicates the operational readiness of the entire airbag system and the belt tensioner.

Airbag system malfunctioning

- ▷ Warning lamp does not come on when the ignition is turned on.
- ▷ The warning lamp lights up continuously.

Automatic deactivation of the front-seat passenger airbags

The concept

The system reads if the front passenger seat is occupied by measuring the human body's resistance.

Front, knee and side airbag on the front passenger's side are either activated or deactivated.

Information

Before transporting a child on the front passenger seat, refer to the safety notes and instructions for children on the front passenger seat, see Children.



WARNING

To ensure the front-seat passenger airbag function, it must be detected, whether a person occupies the front passenger seat. The entire seat cushion area must be used for this purpose. There is risk of injuries or danger to life. Make sure that the front passenger keeps his or her feet in the floor area. ◀

Malfunction of the automatic deactivation system

When transporting older children and adults, the front-seat passenger airbags may be deactivated in certain sitting positions. In this case, the indicator lamp for the front-seat passenger airbags lights up.

In this case, change the sitting position so that the front-seat passenger airbags are activated and the indicator lamp goes out.

If it is not possible to activate the airbags, have the person sit in the rear.

To enable correct recognition of the occupied seat cushion

- ▷ Do not attach covers, cushions, ball mats or other items to the front passenger seat unless they are specifically determined to be safe for use on the front passenger seat.
- ▷ Do not place any electronic devices on the passenger seat if a child restraint system is to be installed on it.
- ▷ Do not place objects under the seat that could press against the seat from below.
- ▷ No moisture in or on the seat.

Indicator lamp for the front-seat passenger airbags



The indicator lamp for the front-seat passenger airbags indicates the operating state of the front-seat passenger airbags.

The lamp indicates whether the airbags are either activated or deactivated.



- ▶ The indicator lamp lights up when a child is properly seated in a child restraint fixing system or when the seat is empty. The airbags on the front passenger side are not activated.
- ▶ The indicator lamp does not light up when, e.g., a correctly seated person of sufficient size is detected on the seat. The airbags on the front passenger side are activated.

Detected child seats

The system generally detects children seated in a child seat, particularly in child seats required by NHTSA when the vehicle was manufactured. After installing a child seat, make sure that the indicator lamp for the front-seat passenger airbags lights up. This indicates that the child seat has been detected and the front-seat passenger airbags are not activated.

Strength of the driver's and front-seat passenger airbag

The explosive power that activates driver's/ front passenger's airbags very much depends on the positions of the driver's/front passenger's seat.

With a respective message appearing on Control Display calibrate the front seats to keep the accuracy of this function over the long-term.

Calibrating the front seats



WARNING

There is risk of jamming when moving the seats. There is risk of injuries or risk of property damage. Make sure that the area of movement of the seat is clear prior to any adjustment. ◀

A corresponding message appears on the Control Display.

1. Press the switch and move the respective seat all the way forward.
2. Press the switch forward again. The seat still moves forward slightly.
3. Readjust the seat to the desired position.

The calibration procedure is completed when the message on the Control Display disappears.

If the message continues to be displayed, repeat the calibration.

If the message does not disappear after a repeat calibration, have the system checked as soon as possible.

Tire Pressure Monitor TPM

The concept

The system monitors tire inflation pressure in the four mounted tires. The system warns you if there is a significant loss of pressure in one or more tires. For this purpose, sensors in the tire valves measure the tire inflation pressure and tire temperature.

Information

With use of the system observe further information found under Tire inflation pressure, refer to page 208.

Functional requirements

The system must have been reset with the correct tire inflation pressure; otherwise, reliable signaling of tire inflation pressure loss is not assured.

Reset the system after each adjustment of the tire inflation pressure and after every tire or wheel change.

Always use wheels with TPM electronics to ensure that the system will operate properly.

Status display

The current status of the Tire Pressure Monitor TPM can be displayed on the Control Display, e.g., whether or not the TPM is active.

On the Control Display:

1. "Vehicle info"
2. "Vehicle status"
3.  "Tire Pressure Monitor (TPM)"

The status is displayed.

Status control display

Tire and system status are indicated by the color of the wheels and a text message on the Control Display.

All wheels green

System is active and will issue a warning relative to the tire inflation pressures stored during the last reset.

One wheel is yellow

A flat tire or major drop in inflation pressure in the indicated tire.

All wheels are yellow

A flat tire or major drop in inflation pressure in several tires.

Wheels, gray

The system cannot detect a flat tire. Reasons for this may be:

- ▷ The system is being reset.
- ▷ Malfunction.

Status information

The status control display additionally shows the current tire inflation pressures and, depending on the model, tire temperatures. It shows the actual values read; they may vary depending on driving style or weather conditions.

Carry out reset

Reset the system after each adjustment of the tire inflation pressure and after every tire or wheel change.

On the Control Display and on the vehicle:

1. "Vehicle info"
2. "Vehicle status"
3.  "Perform reset"
4. Start the engine - do not drive off.
5. Reset tire inflation pressure: "Perform reset".
6. Drive away.

The wheels are displayed in gray and the status is displayed.

After driving faster than 19 mph/30 km/h for a short period, the set tire inflation pressures are accepted as reference values. The reset is completed automatically while driving.

The progress of the reset is displayed.

After a successfully completed Reset, the wheels on the Control Display are shown in green and "Tire Pressure Monitor (TPM) active" is displayed.

You may interrupt this trip at any time. When you continue the reset resumes automatically.

Low tire pressure message



The yellow warning lamp lights up. A Check Control message is displayed.

- ▷ There is a flat tire or a major loss in tire inflation pressure.
 - ▷ No reset was performed for the system. The system therefore issues a warning based on the tire inflation pressures before the last reset.
1. Reduce your speed and stop cautiously. Avoid sudden braking and steering maneuvers.
 2. Check whether the vehicle is fitted with normal tires or run-flat tires.

Run-flat tires, refer to page 214, are labeled with a circular symbol containing the letters RSC marked on the tire's sidewall.



WARNING

A damaged regular tire with low or missing tire inflation pressure impacts handling, such as steering and braking response. Run-flat tires can maintain limited stability. There is risk of an accident. Do not continue driving if the vehicle is not equipped with run-flat tires. Observe the information on run-flat tires and continued driving with these tires. ◀

A low tire inflation pressure might turn on DSC Dynamic Stability Control.

Actions in the event of a flat tire

Normal tires

1. Identify the damaged tire.

Do this by checking the air pressure in all four tires.

The tire pressure gage of the Mobility System, refer to page 215, can possibly be used for this purpose.

If the tire inflation pressure in all four tires is shown to be correct, it is possible that the Tire Pressure Monitor did not perform a reset. Then perform the reset.

If identification of flat tire damage is not possible, please contact a dealer's service center or another qualified service center or repair shop.

2. Replace the damaged tire with the emergency wheel as needed or fix it where applicable with the Mobility System.

Use of tire sealant, e.g., the Mobility System, may damage the TPM wheel electronics. In this case, have the electronics checked at the next opportunity and have them replaced if needed.

Run-flat tires

Maximum speed

You may continue driving with a damaged tire at speeds up to 50 mph/80 km/h.

Continued driving with a flat tire

If continuing to drive with a damaged tire:

1. Avoid sudden braking and steering maneuvers.
2. Do not exceed a speed of 50 mph/80 km/h.
3. Check the air pressure in all four tires at the next opportunity.

If the tire inflation pressure in all four tires is shown to be correct, it is possible that the Tire Pressure Monitor did not perform a reset. In that case, carry out a reset.

Possible driving distance with complete loss of tire inflation pressure:

The possible driving distance after a loss of tire inflation pressure depends on cargo load, driving style and road conditions.

A vehicle with an average load has a possible driving range of approx. 50 miles/80 km.

A vehicle with a damaged tire reacts differently, e.g., it has reduced lane stability during braking, a longer braking distance and different self-steering properties. Adjust your driving style accordingly. Avoid abrupt steering maneuvers or driving over obstacles, e.g., curbs, potholes, etc.

Because the possible driving distance depends on how the vehicle is used during the trip, the actual distance may be shorter or longer depending on the driving speed, road conditions, external temperature, cargo load, etc.



WARNING

Your vehicle handles differently when a run-flat tire is damaged and has low or missing tire inflation pressure, e.g., your lane stability is reduced when braking, braking distances are

longer and the self-steering properties will change. There is risk of an accident.

Drive moderately and do not exceed a speed of 50 mph/80 km/h. ◀

Final tire failure

Vibrations or loud noises while driving can indicate the final failure of a tire.

Reduce speed and stop; otherwise, pieces of the tire could come loose and cause an accident.

Do not continue driving. Contact a dealer's service center or another qualified service center or repair shop.

Required tire inflation pressure check message

A Check Control message is displayed in the following situations

- ▶ The system has detected a wheel change, but no reset was done.
- ▶ Inflation was not carried out according to specifications.
- ▶ The tire inflation pressure has fallen below the level of the last confirmation.

In this case:

- ▶ Check the tire pressure and correct as needed.
- ▶ Carry out a reset of the system after a tire change.

System limits

The system does not function properly if a reset has not been carried out, e.g., a flat tire is reported though tire inflation pressures are correct.

The tire inflation pressure depends on the tire's temperature. Driving or exposure to the sun will increase the tire's temperature, thus increasing the tire inflation pressure. The tire inflation pressure is reduced when the tire temperature falls again. These circumstances

may cause a warning when temperatures fall very sharply.

The system cannot indicate sudden serious tire damage caused by external circumstances.

Malfunction



The yellow warning lamp flashes and then lights up continuously. A Check Control message is displayed. No flat tire or loss of tire inflation pressure can be detected.

Examples and recommendations in the following situations:

- ▶ A wheel without TPM electronics is mounted: Have it checked by a dealer's service center or another qualified service center or repair shop as needed.
- ▶ Malfunction: Have system checked by a dealer's service center or another qualified service center or repair shop.
- ▶ TPM was unable to complete the reset. Reset the system again.
- ▶ Interference through systems or devices with the same radio frequency: After leaving the area of the interference, the system automatically becomes active again.

Declaration according to NHTSA/ FMVSS 138 Tire Pressure Monitoring System

Each tire, including the spare (if provided) should be checked monthly when cold and inflated to the inflation pressure recommended by the vehicle manufacturer on the vehicle placard or tire inflation pressure label. (If your vehicle has tires of a different size than the size indicated on the vehicle placard or tire inflation pressure label, you should determine the proper tire inflation pressure for those tires.) As an added safety feature, your vehicle has been equipped with a tire pressure monitoring system (TPMS) that illuminates a low tire pressure telltale when one or more of your tires is significantly under-inflated. Accordingly, when

the low tire pressure telltale illuminates, you should stop and check your tires as soon as possible, and inflate them to the proper pressure. Driving on a significantly under-inflated tire causes the tire to overheat and can lead to tire failure. Under-inflation also reduces fuel efficiency and tire tread life, and may affect the vehicle's handling and stopping ability. Please note that the TPMS is not a substitute for proper tire maintenance, and it is the driver's responsibility to maintain correct tire pressure, even if under-inflation has not reached the level to trigger illumination of the TPMS low tire pressure telltale. Your vehicle has also been equipped with a TPMS malfunction indicator to indicate when the system is not operating properly. The TPMS malfunction indicator is combined with the low tire pressure telltale. When the system detects a malfunction, the telltale will flash for approximately one minute and then remain continuously illuminated. This sequence will continue upon subsequent vehicle start-ups as long as the malfunction exists. When the malfunction indicator is illuminated, the system may not be able to detect or signal low tire pressure as intended. TPMS malfunctions may occur for a variety of reasons, including the installation of replacement or alternate tires or wheels on the vehicle that prevent the TPMS from functioning properly. Always check the TPMS malfunction telltale after replacing one or more tires or wheels on your vehicle to ensure that the replacement or alternate tires and wheels allow the TPMS to continue to function properly.

FTM Flat Tire Monitor

The concept

The system detects tire inflation pressure loss on the basis of rotation speed differences between the individual wheels while driving.

In the event of a tire inflation pressure loss, the diameter and therefore the rotational speed of

the corresponding wheel changes. This will be detected and reported as a flat tire.

The system does not measure the actual inflation pressure in the tires.

Functional requirements

The system must have been initialized when the tire inflation pressure was correct; otherwise, reliable flagging of a flat tire is not assured. Initialize the system after each correction of the tire inflation pressure and after every tire or wheel change.

Status display

The current status of the Flat Tire Monitor can be displayed on the Control Display, e.g., whether or not the FTM is active.

On the Control Display:

1. "Vehicle info"
2. "Vehicle status"
3. (!) "Flat Tire Monitor (FTM)"

The status is displayed.

Initialization

When initializing the once set inflation tire pressures serve as reference values in order to detect a flat tire. Initialization is started by confirming the tire inflation pressures.

Do not initialize the system when driving with snow chains.

On the Control Display:

1. "Vehicle info"
2. "Vehicle status"
3. (!) RESET "Perform reset"
4. Start the engine - do not drive off.
5. Start the initialization with "Perform reset".
6. Drive away.

The initialization is completed while driving, which can be interrupted at any time.

The initialization automatically continues when driving resumes.

Indication of a flat tire



The yellow warning lamp lights up. A Check Control message is displayed.

There is a flat tire or a major loss in tire inflation pressure.

1. Reduce your speed and stop cautiously. Avoid sudden braking and steering maneuvers.
2. Check whether the vehicle is fitted with normal tires or run-flat tires.
Run-flat tires, refer to page 214, are labeled with a circular symbol containing the letters RSC marked on the tire's sidewall.



WARNING

A damaged regular tire with low or missing tire inflation pressure impacts handling, such as steering and braking response. Run-flat tires can maintain limited stability. There is risk of an accident. Do not continue driving if the vehicle is not equipped with run-flat tires. Observe the information on run-flat tires and continued driving with these tires. ← ۸۸۶۲۰۸۵ - تلفن شماره ریزی

When a flat tire is indicated, DSC Dynamic Stability Control is switched on if needed.

System limits

A natural, even tire inflation pressure loss in all four tires will not be recognized. Therefore, check the tire inflation pressure regularly.

Sudden serious tire damage caused by external circumstances cannot be recognized in advance.

The system could be delayed or malfunction in the following situations:

- ▷ When the system has not been initialized.
- ▷ When driving on a snowy or slippery road surface.
- ▷ Sporty driving style: spinning traction wheels, high lateral acceleration (drifting).
- ▷ When driving with snow chains.

Actions in the event of a flat tire

Normal tires

1. Identify the damaged tire.

Do this by checking the air pressure in all four tires.

The tire pressure gage of the Mobility System, refer to page 215, can possibly be used for this purpose.

If the tire inflation pressure in all four tires is correct, the Flat Tire Monitor may not have been initialized. In this case, initialize the system.

If identification of flat tire damage is not possible, please contact a dealer's service center or another qualified service center or repair shop.

2. Replace the damaged tire with the emergency wheel as needed or fix it where applicable with the Mobility System.

Run-flat tires

Maximum speed

You may continue driving with a damaged tire at speeds up to 50 mph/80 km/h.

Continued driving with a flat tire

If continuing to drive with a damaged tire:

1. Avoid sudden braking and steering maneuvers.
2. Do not exceed a speed of 50 mph/80 km/h.
3. Check the air pressure in all four tires at the next opportunity.

If the tire inflation pressure in all four tires is correct, the Flat Tire Monitor may not have been initialized. In this case, initialize the system.

Possible driving distance with complete loss of tire inflation pressure:

The possible driving distance after a loss of tire inflation pressure depends on cargo load, driving style and road conditions.

A vehicle with an average load has a possible driving range of approx. 50 miles/80 km.

A vehicle with a damaged tire reacts differently, e.g., it has reduced lane stability during braking, a longer braking distance and different self-steering properties. Adjust your driving style accordingly. Avoid abrupt steering maneuvers or driving over obstacles, e.g., curbs, potholes, etc.

Because the possible driving distance depends on how the vehicle is used during the trip, the actual distance may be shorter or longer depending on the driving speed, road conditions, external temperature, cargo load, etc.

WARNING

Your vehicle handles differently when a run-flat tire is damaged and has low or missing tire inflation pressure, e.g., your lane stability is reduced when braking, braking distances are longer and the self-steering properties will change. There is risk of an accident.

Drive moderately and do not exceed a speed of 50 mph/80 km/h. ◀

Final tire failure

Vibrations or loud noises while driving can indicate the final failure of a tire.

Reduce speed and stop; otherwise, pieces of the tire could come loose and cause an accident.

Do not continue driving. Contact a dealer's service center or another qualified service center or repair shop.

Intelligent Safety

The concept

Intelligent Safety enables central operation of the driver assistance system. Depending on

how the vehicle is equipped, Intelligent Safety consists of one or more systems that can help prevent a imminent collision.

- ▷ Front-end collision warning, refer to page 116.
- ▷ Pedestrian warning, refer to page 122.
- ▷ Lane departure warning, refer to page 128.
- ▷ Active Blind Spot Detection, refer to page 130.

Information

WARNING

Indicators and warnings do not relieve from the personal responsibility. Due to system limits, warnings or reactions of the system may not be output or they may be output too late or incorrectly. There is risk of an accident. Adjust the driving style to the traffic conditions. Watch traffic closely and actively interfere in the respective situations. ◀

WARNING

Due to system limits, individual functions can malfunction during tow-starting/towing with the Intelligent Safety systems activated, e.g. approach control warning with light braking function. There is risk of an accident. Switch all Intelligent Safety systems off prior to tow-starting/towing. ◀

Overview

Button in the vehicle





Intelligent Safety button

Switching on/off

Some Intelligent Safety systems are automatically active after every departure. Some Intelligent Safety systems activate according to the last setting.



Press button briefly:

- ▶ The menu for the intelligent safety system is displayed. The systems are individually switched off according to their respective settings.
- ▶ LED lights up orange or goes out respective to their individual settings.

Adjust as needed. Individual settings are stored for the profile currently used.



Press button again:

- ▶ All Intelligent Safety systems are activated.
- ▶ The LED lights up green.



Hold down button:

- ▶ All Intelligent Safety systems are turned off.
- ▶ The LED goes out.

Front-end collision warning

Depending on the equipment, the collision warning system consists of one of the following functions:

- ▶ Front-end collision warning with City Braking function, refer to page 116.
- ▶ Front-end collision warning with braking function, refer to page 119

Front-end collision warning with City Braking function

The concept

The system can help prevent accidents. If an accident cannot be prevented, the system will help reduce the collision speed.

The system sounds a warning before an imminent collision and actuates brakes independently if needed.

The automatic braking intervention is done with limited force and duration.

A camera in the area of the rearview mirror controls the system.

The front-end collision warning is available even if cruise control has been deactivated.

With the vehicle approaching another vehicle intentionally, the collision warning and braking are delayed in order to avoid false system reactions.

General information

The system warns at two levels of an imminent danger of collision at speeds from approx.

3 mph/5 km/h. Time of warnings may vary with the current driving situation.

Appropriate braking kicks in at speeds of up to 35 mph/60 km/h.

Detection range

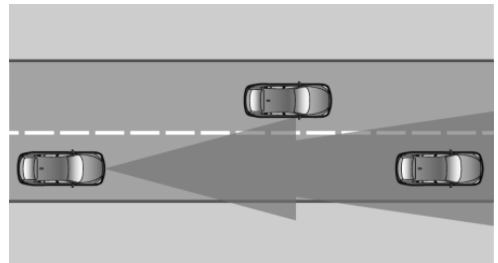

It responds to objects if they are detected by the system.

Information



WARNING

Indicators and warnings do not relieve from the personal responsibility. Due to system limits, warnings or reactions of the system may not be output or they may be output too late or incorrectly. There is risk of an accident. Adjust the driving style to the traffic conditions. Watch traffic closely and actively interfere in the respective situations. ◀



WARNING

Due to system limits, individual functions can malfunction during tow-starting/towing with the Intelligent Safety systems activated, e.g. approach control warning with light braking function. There is risk of an accident. Switch all Intelligent Safety systems off prior to tow-starting/towing. ◀

Overview

Button in the vehicle

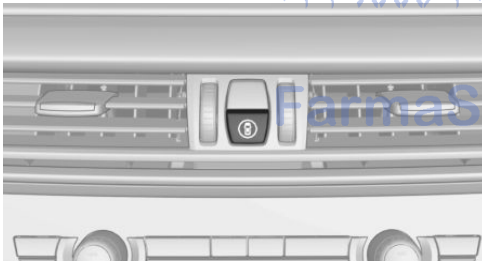

Intelligent Safety button

Camera

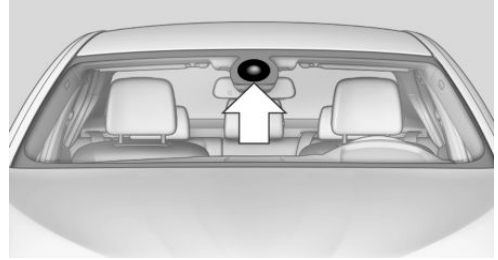

The camera is installed near the interior rearview mirror.

Keep the windshield in the area behind the interior rearview mirror clean and clear.

Switching on/off

Switching on automatically

The system is automatically active after every driving-off.

Switching on/off manually



Press button briefly:

- ▶ The menu for the intelligent safety system is displayed. The systems are individually switched off according to their respective settings.

- ▶ LED lights up orange or goes out respective to their individual settings.

Adjust as needed. Individual settings are stored for the profile currently used.



Press button again:

- ▶ All Intelligent Safety systems are activated.
- ▶ The LED lights up green.



Hold down button:

- ▶ All Intelligent Safety systems are turned off.
- ▶ The LED goes out.

Setting the warning time

The warning time can be set via iDrive.

1. "Settings"
2. "Frontal Coll. Warning"
3. Activate the desired time on the Control Display.

The selected time is stored for the profile currently used.

Warning with braking function

Display

If a collision with a recognized vehicle is imminent a warning symbol appears in the instrument cluster and in the Head-Up Display.

Symbol	Measure
	Symbol lights up red: prewarning. Brake and increase distance.
	Symbol flashes red and an acoustic signal sounds: acute warning. You are requested to intervene by braking or make an evasive maneuver.

Prewarning

This warning is issued, e.g., when there is the impending danger of a collision or the distance to the vehicle ahead is too small.

The driver must intervene actively when there is a prewarning.

Acute warning with braking function

Acute warning is displayed in case of the imminent danger of a collision when the vehicle approaches another object at a relatively high differential speed.

The driver must intervene actively when there is an acute warning. If necessary, the driver is assisted by a minor automatic braking intervention in a possible risk of collision.

Acute warnings can also be triggered without previous forewarning.

Braking intervention

The warning prompts the driver himself/herself to react. During a warning, the maximum braking force is used. Premise for the brake booster is sufficiently quick and hard stepping on the brake pedal. The system can assist with some braking intervention if there is risk of a collision. At low speeds vehicles may thus come to a complete stop.

The braking intervention is executed only if DSC Dynamic Stability Control is switched on and Dynamic Traction Control DTC is activated.

The braking intervention can be interrupted by stepping on the accelerator pedal or by actively moving the steering wheel.

Object detection can be restricted. Limitations of the detection range and functional restrictions are to be considered.

System limits تلفن

Detection range

The system's detection potential is limited. Thus a system reaction might not come or might come late.

E. g. the following situations may not be detected:

- ▷ Slow moving vehicles when you approach them at high speed.
- ▷ Vehicles that suddenly swerve in front of you, or sharply decelerating vehicles.
- ▷ Vehicles with an unusual rear appearance.
- ▷ Two-wheeled vehicles ahead of you.

Functional limitations

The system may not be fully functional in the following situations:

- ▷ In heavy fog, rain, sprayed water or snow-fall.

- In tight curves.
- If the driving stability control systems are limited or deactivated, e.g., DSC OFF.
- If, depending on the vehicle equipment version, the field of view of the camera in the mirror or the radar sensor is dirty or obscured.
- Up to 10 seconds after the start of the engine, via the Start/Stop button.
- During calibration of the camera immediately after vehicle delivery.
- If there are constant blinding effects because of oncoming light, e. g., from the sun low in the sky.

Warning sensitivity

The more sensitive the warning settings are, e.g. the warning time, the more warnings are displayed. However, there may also be an excess of false warnings.

Collision warning with braking function

The concept

The system can help prevent accidents. If an accident cannot be prevented, the system will help reduce the collision speed.

The system sounds a warning before an imminent collision and actuates brakes independently if needed.

The automatic braking intervention may be executed with maximum braking force and for a brief period only as necessary.

If the vehicle is equipped with Active Cruise Control with Stop & Go, the front-end collision warning is controlled via the cruise control radar sensor in conjunction with a camera.

The front-end collision warning is available even if cruise control has been deactivated.

With the vehicle approaching another vehicle intentionally, the collision warning and braking

are delayed in order to avoid false system reactions.

General information

The system issues a two-phase warning of a possible danger of collision with vehicles at speeds above approx. 3 mph/5 km/h. Time of warnings may vary with the current driving situation.

Detection range

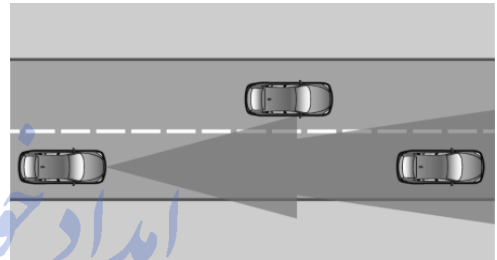

It responds to objects if they are detected by the system.

Information



WARNING

Indicators and warnings do not relieve from the personal responsibility. Due to system limits, warnings or reactions of the system may not be output or they may be output too late or incorrectly. There is risk of an accident. Adjust the driving style to the traffic conditions. Watch traffic closely and actively interfere in the respective situations. ◀



WARNING

Due to system limits, individual functions can malfunction during tow-starting/towing with the Intelligent Safety systems activated, e.g. approach control warning with light braking function. There is risk of an accident. Switch all Intelligent Safety systems off prior to tow-starting/towing. ◀

Overview

Button in the vehicle



 Intelligent Safety button

Radar sensor

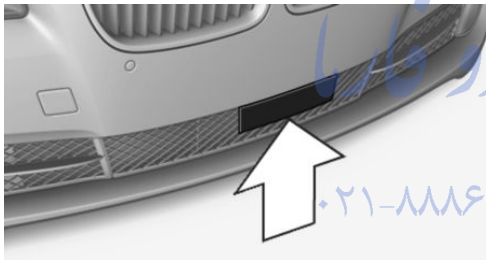

The radar sensor is located in the lower area of the front bumper.

Always keep radar sensor clean and unobstructed.

Camera

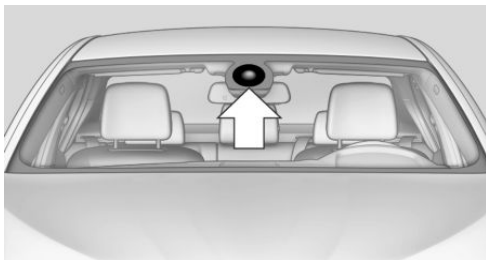

The camera is installed near the interior rearview mirror.

Keep the windshield in the area behind the interior rearview mirror clean and clear.

Switching on/off

Switching on automatically

The system is automatically active after every driving-off.

Switching on/off manually



Press button briefly:

- ▶ The menu for the intelligent safety system is displayed. The systems are individually switched off according to their respective settings.
- ▶ LED lights up orange or goes out respective to their individual settings. Adjust as needed. Individual settings are stored for the profile currently used.



Press button again:

- ▶ All Intelligent Safety systems are activated.
- ▶ The LED lights up green.



Hold down button:

- ▶ All Intelligent Safety systems are turned off.
- ▶ The LED goes out.

Setting the warning time

The warning time can be set via iDrive.



1. "Settings"
2. "Frontal Coll. Warning"
3. Activate the desired time on the Control Display.

The selected time is stored for the profile currently used.

Warning with braking function

Display

If a collision with a recognized vehicle is imminent a warning symbol appears in the instrument cluster and in the Head-Up Display.

Symbol	Measure
	Symbol lights up red: prewarning. Brake and increase distance.
	Symbol flashes red and an acoustic signal sounds: acute warning. You are requested to intervene by braking or make an evasive maneuver.

Prewarning

This warning is issued, e.g., when there is the impending danger of a collision or the distance to the vehicle ahead is too small.

The driver must intervene actively when there is a prewarning.

Acute warning with braking function

Acute warning is displayed in case of the imminent danger of a collision when the vehicle approaches another object at a relatively high differential speed.

The driver must intervene actively when there is an acute warning. If necessary, the driver is assisted by an automatic braking intervention in a possible risk of collision.

Acute warnings can also be triggered without previous forewarning.

Braking intervention

The warning prompts the driver himself/herself to react. During a warning, the maximum braking force is used. Premise for the brake booster is sufficiently quick and hard stepping on the brake pedal. The system can assist with automatic braking intervention if there is risk of

a collision. The intervention can bring the vehicle to a complete stop.

The braking intervention is executed only if DSC Dynamic Stability Control is switched on and Dynamic Traction Control DTC is activated.

Above approx. 130 mph/210 km/h the braking intervention occurs as a brief braking pressure. No automatic delay occurs.

The braking intervention can be interrupted by stepping on the accelerator pedal or by actively moving the steering wheel.

Object detection can be restricted. Limitations of the detection range and functional restrictions are to be considered.

System limits

Detection range

The system's detection potential is limited.

Thus a system reaction might not come or might come late.

E. g. the following situations may not be detected:

- ▷ Slow moving vehicles when you approach them at high speed.
- ▷ Vehicles that suddenly swerve in front of you, or sharply decelerating vehicles.
- ▷ Vehicles with an unusual rear appearance.
- ▷ Two-wheeled vehicles ahead of you.

Functional limitations

The system may not be fully functional in the following situations:

- ▷ In heavy fog, rain, sprayed water or snowfall.
- ▷ In tight curves.
- ▷ If the driving stability control systems are limited or deactivated, e.g., DSC OFF.
- ▷ If, depending on the vehicle equipment version, the field of view of the camera in

the mirror or the radar sensor is dirty or obscured.

- ▷ Up to 10 seconds after the start of the engine, via the Start/Stop button.
- ▷ During calibration of the camera immediately after vehicle delivery.
- ▷ If there are constant blinding effects because of oncoming light, e. g., from the sun low in the sky.

Warning sensitivity

The more sensitive the warning settings are, e.g. the warning time, the more warnings are displayed. However, there may also be an excess of false warnings.

Pedestrian warning

Depending on how the vehicle is equipped, the function warns of an imminent collision with pedestrians during daytime or nighttime.

The function is subdivided into the following systems:

- ▷ During daytime: Pedestrian warning with city braking function, refer to page 122
- ▷ At night: Night vision, refer to page 124

Pedestrian warning with city braking function

The concept

The system can help prevent accidents with pedestrians.

The system issues a warning in the city driving speed area if there is imminent danger of a collision with pedestrians and includes a braking function.

The camera in the area of the rearview mirror controls the system.

General information

With sufficient brightness, the system warns about possible collision danger with pedestrians starting at approx. 6 mph/10 km/h to approx. 35 mph/60 km/h and assists with braking before a collision.

Under those circumstances it reacts to people who are within the detection range of the system.

Detection range

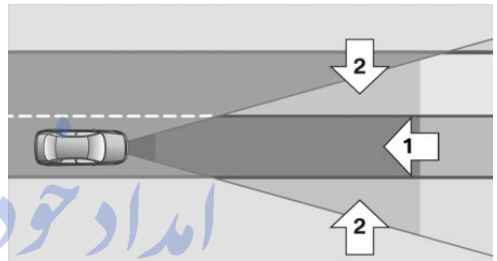

The detection area in front of the vehicle is divided into two areas

- ▷ Central area, arrow 1, directly in front of the vehicle.
- ▷ Expanded area, arrow 2, to the right and left.

A collision is imminent if pedestrians are located within the central area. A warning is issued about pedestrians who are located within the extended area only if they are moving in the direction of the central area.

Information



WARNING

Indicators and warnings do not relieve from the personal responsibility. Due to system limits, warnings or reactions of the system may not be output or they may be output too late or incorrectly. There is risk of an accident. Adjust the driving style to the traffic conditions. Watch traffic closely and actively interfere in the respective situations. ◀

**WARNING**

Due to system limits, individual functions can malfunction during tow-starting/towing with the Intelligent Safety systems activated, e.g. approach control warning with light braking function. There is risk of an accident. Switch all Intelligent Safety systems off prior to tow-starting/towing. ◀

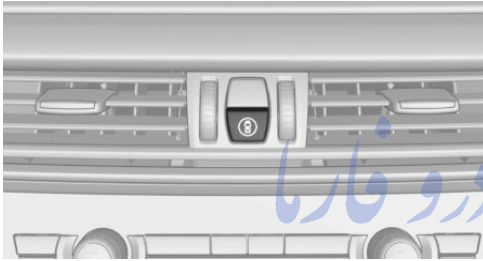
Overview**Button in the vehicle**

Intelligent Safety button

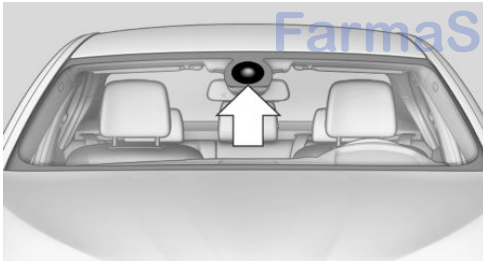
Camera

The camera is installed near the interior rearview mirror.

Keep the windshield in the area behind the interior rearview mirror clean and clear.

Switching on/off**Switching on automatically**

The system is automatically active after every driving-off.

Switching on/off manually

Press button briefly:

- ▶ The menu for the intelligent safety system is displayed. The systems are individually switched off according to their respective settings.



- ▶ LED lights up orange or goes out respective to their individual settings.

Adjust as needed. Individual settings are stored for the profile currently used.



Press button again:

- ▶ All Intelligent Safety systems are activated.
- ▶ The LED lights up green.



Hold down button:

- ▶ All Intelligent Safety systems are turned off.
- ▶ The LED goes out.

Warning with braking function**Display**

If a collision with a person detected in this way is imminent, a warning symbol appears on the instrument cluster and in the Head-up Display.



The red symbol is displayed and a signal sounds.



With instrument display: The red symbol is displayed and a signal sounds.

Intervene immediately by braking or make an evasive maneuver.

Braking intervention

The warning prompts the driver himself/herself to react. During a warning, the maximum braking force is used. Premise for the brake booster is sufficiently quick and hard stepping on the brake pedal. The system can assist with some braking intervention if there is risk of a collision. At low speeds vehicles may thus come to a complete stop.

The braking intervention is executed only if DSC Dynamic Stability Control is switched on and Dynamic Traction Control DTC is activated.

The braking intervention can be interrupted by stepping on the accelerator pedal or by actively moving the steering wheel.

Object detection can be restricted. Limitations of the detection range and functional restrictions are to be considered.

System limits

Detection range

The detection potential of the camera is limited.

Thus a warning might not be issued or be issued late.

E. g. the following situations may not be detected:

- ▷ Partially covered pedestrians.
- ▷ Pedestrians that are not detected as such because of the viewing angle or contour.
- ▷ Pedestrians outside of the detection range.
- ▷ Pedestrians having a body size less than 32 in/80 cm.

Functional limitations

The system may not be fully functional or may not be available in the following situations:

The system may not be fully functional in the following situations:

- ▷ In heavy fog, rain, sprayed water or snow-fall.
- ▷ In tight curves.
- ▷ If the driving stability control systems are deactivated, e.g. DSC OFF.
- ▷ If the field of view of the camera or the front windshield are dirty or covered.
- ▷ Up to 10 seconds after the start of the engine, via the Start/Stop button.
- ▷ During calibration of the camera immediately after vehicle delivery.
- ▷ If there are constant blinding effects because of oncoming light, e. g., from the sun low in the sky.
- ▷ When it is dark outside.

Night Vision with Pedestrian and Animal Detection

The concept

Night Vision with pedestrian and animal detection is a night vision system.

An infrared camera scans the area in front of the vehicle and issues a warning if it detects pedestrians and animals on the street. Warm objects that are similar in shape to human beings or animals are detected by the system. If necessary, the heat image can be displayed on the Control Display.

Heat image



The image shows the heat radiated by objects in the field of view of the camera.

Warm objects have a light appearance and cold objects a dark appearance.

The ability to detect an object depends on the temperature difference between the object and the background and on the level of heat radiation emitted by the object. Objects that are similar in temperature to the environment or that radiate very little heat are difficult to detect.

For safety reasons, when driving at speeds above approx. 3 mph/5 km/h and in low ambient light, the image is only displayed when the low beams are activated.

A still image is displayed at regular intervals for a fraction of a second.

Pedestrian and animal detection

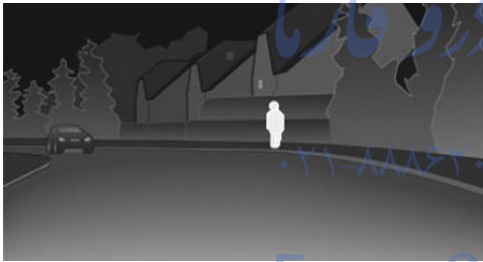

Object detection and warning only functions in darkness.

Objects whose form is similar to people with sufficient heat radiation are detected.

In addition, the system also detects animals above a certain minimum size, e.g., deer.

Display on the Control Display with heat image activated:

- ▶ People detected by the system: in light yellow.
- ▶ Animals detected by the system: in dark yellow.

Range of object detection, with good ambient conditions:

- ▶ Pedestrian detection: up to approx. 330 ft/100 m

- ▶ Detection of large animals: up to approx. 490 ft/150 m
- ▶ Detection of medium animals: up to approx. 230 ft/70 m

Environmental influences can limit the availability of object detection.

If the vehicle systems detect that the vehicle is located in a residential area, the animal detection is temporarily switched off.

Information



WARNING

The system does not relieve from the personal responsibility to correctly assess visibility and traffic situation. There is risk of an accident. Adjust the driving style to the traffic conditions. Watch traffic closely and actively interfere in the respective situations. ◀

Overview

Buttons in the vehicle



Intelligent Safety button





Switch on/switch off heat image

Camera

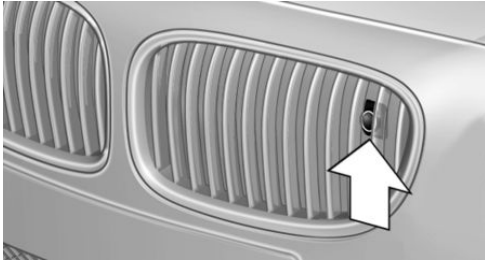

The camera is automatically heated when the external temperatures are low.

The camera lens is automatically cleaned together with the headlights.

Switching on/off

Switching on automatically

When it is dark outside, the system is automatically active after every driving-off.

Switching on/off manually



Press button briefly:

- ▶ The menu for the intelligent safety system is displayed. The systems are individually switched off according to their respective settings.
- ▶ LED lights up orange or goes out respective to their individual settings.

Adjust as needed. Individual settings are stored for the profile currently used.



Press button again:

- ▶ All Intelligent Safety systems are activated.
- ▶ The LED lights up green.



Hold down button:

- ▶ All Intelligent Safety systems are turned off.
- ▶ The LED goes out.

Switching on heat image additionally

The heat image from the Night Vision camera can also be displayed on the Control Display. This function has no effect on object detection.



Press button.

The image from the camera is displayed on the Control Display.

Adjustments via the iDrive

With heat image switched on:

1. Press the controller.
2. Select brightness or contrast.
 - ▶ ☀ Select the symbol.
 - ▶ ● Select the symbol.
3. Turn the controller until the desired setting is selected.
4. Press the controller.

Display

Warning of people or animals in danger

If a collision with a person or an animal detected in this way is imminent, a warning symbol appears on the instrument cluster and in the Head-up Display.

Although both the shape and the heat radiation are analyzed, false warnings cannot be ruled out.

Warning area in front of the vehicle

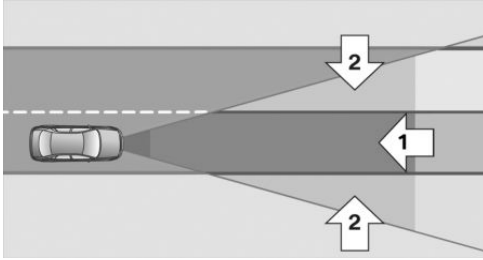

The warning area for the pedestrian warning consists of two parts:

- ▶ Central area, arrow 1, directly in front of the vehicle.
- ▶ Expanded area, arrow 2, to the right and left.

With animal warnings, no distinction is made between the central or expanded area.

The entire area moves along with the vehicle in the direction of the steering angle and changes with the vehicle speed. As the vehicle speed increases, the area becomes longer and wider, e.g.

Prewarning



The yellow symbol is displayed when a person is detected in the central area immediately in front of the vehicle.

The yellow symbol is displayed when a person in the extended area is moving from the right or left towards the central area.

The displayed symbol can vary with the people detected.

Intervene actively by braking or make an evasive maneuver.



When animals are detected, an animal symbol is displayed. The symbol also shows the side of the road on which the animal was detected. Intervene actively by braking or make an evasive maneuver.

Acute warning



The red symbol is displayed and a signal sounds.



With instrument display: The red symbol is displayed and a signal sounds.



When animals are detected, a red animal symbol is displayed with the signal tone.



Red symbol in the instrument cluster.



Red symbol in the instrument display.

Intervene immediately by braking or make an evasive maneuver.

Display in the Head-up Display



The warning is displayed simultaneously in the Head-up Display and on the instrument cluster. The displayed symbol can vary with the people detected.

When animals are detected, an animal symbol is displayed.

System limits

Basic limits

System operation is limited in situations such as the following:

- ▶ On steep hills, in steep depressions or in tight curves.
- ▶ When the camera is dirty or the protective glass is damaged.
- ▶ In heavy fog, rain or snowfall.
- ▶ At very high external temperatures.

Limits of pedestrian and animal detection

In some situations, it may occur that pedestrians are detected as animals or animals as pedestrians.

Small animals are not detected by the object detection function, even if they are clearly visible in the image.

Limited detection, e.g. in the following circumstances:

- ▷ People or animals who are fully or partially covered, especially when their heads are covered.
- ▷ People who are not in an upright position, e.g., lying down.
- ▷ Cyclists on unconventional bicycles (e.g., recumbent bicycles).
- ▷ After physical damage to the system, e.g., after an accident.

No display on the rear screen

The image from Night Vision cannot be displayed on the rear screen.

Lane departure warning

The concept

Starting at a specific speed, this system alerts you when the vehicle on streets with lane markings is about to leave the lane. This speed, depending on the country version, is between 35 mph/55 km/h and 45 mph/70 km/h.

The steering wheel begins vibrating gently in the event of warnings. The time of the warning may vary depending on the current driving situation.

The system does not provide a warning if the turn signal is set before leaving the lane.

Information

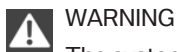

WARNING

The system does not relieve from the personal responsibility to correctly assess route and traffic situation. There is risk of an accident. Adjust the driving style to the traffic conditions. Watch traffic closely and actively

interfere in the respective situations. In the event of a warning, do not unnecessarily jerk the steering wheel. ◀

Overview

Button in the vehicle



Intelligent Safety button

Camera

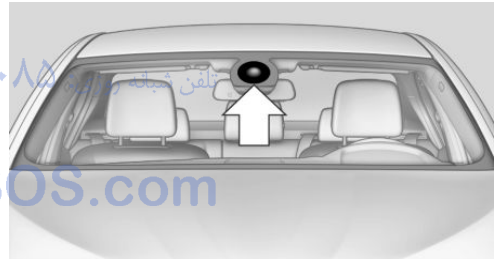

The camera is installed near the interior rearview mirror.

Keep the windshield in the area behind the interior rearview mirror clean and clear.

Switching on/off

Switching on automatically

The lane departure warning is automatically activated after departure, if the function was switched on the last time the engine was stopped.

Switching on/off manually



Press button briefly:

- ▷ The menu for the intelligent safety system is displayed. The systems are individually switched off according to their respective settings.
- ▷ LED lights up orange or goes out respective to their individual settings.

Adjust as needed. Individual settings are stored for the profile currently used.



Press button again:

- ▷ All Intelligent Safety systems are activated.
- ▷ The LED lights up green.



Hold down button:

- ▷ All Intelligent Safety systems are turned off.
- ▷ The LED goes out.

Display in the instrument cluster



- ▷ Lines: system is activated.
- ▷ Arrows: at least one lane marking was detected and warnings can be issued.

Display in the instrument display



- ▷ Symbol orange: system is activated.
- ▷ Green symbol: at least one lane marking was detected and warnings can be issued.

Issued warning

If you leave the lane and if a lane marking has been detected, the steering wheel begins vibrating.

If the turn signal is set before changing the lane, a warning is not issued.

End of warning

The warning is canceled in the following situations:

- ▷ Automatically after approx. 3 seconds.
- ▷ When returning to your own lane.
- ▷ When braking hard.
- ▷ When using the turn signal.

System limits

The system may not be fully functional in the following situations:

- ▷ In heavy fog, rain or snowfall.
- ▷ In the event of missing, worn, poorly visible, merging, diverging, or multiple lane markings such as in construction areas.
- ▷ When lane markings are covered in snow, ice, dirt or water.
- ▷ In tight curves or on narrow lanes.
- ▷ When the lane markings are covered by objects.
- ▷ When driving very close to the vehicle in front of you.
- ▷ When driving toward bright lights.
- ▷ When the windshield in front of the interior rearview mirror is fogged over, dirty or covered with stickers, etc.
- ▷ During calibration of the camera immediately after vehicle delivery.

Active Blind Spot Detection

The concept

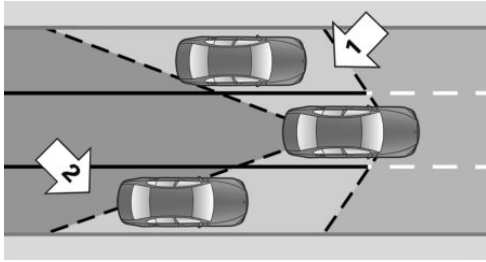

Two radar sensors in the rear bumper monitor the area behind and next to the vehicle at speeds above approx. 30 mph/50 km/h.

The system indicates whether there are vehicles in the blind spot, arrow 1, or approaching from behind on the adjacent lane, arrow 2.

The lamp in the exterior mirror housing is dimmed.

Before you change lanes after setting the turn signal, the system issues a warning in the situations described above.

The lamp in the exterior mirror housing flashes and the steering wheel vibrates.

Information



WARNING

The system does not relieve from the personal responsibility to correctly assess visibility and traffic situation. There is risk of an accident. Adjust the driving style to the traffic conditions. Watch traffic closely and actively interfere in the respective situations. ◀

Overview

Button in the vehicle



Intelligent Safety button

Radar sensors



The radar sensors are located in the rear bumper.

Switching on/off

Switching on automatically

The Active Blind Spot Detection is automatically activated after departure, if the function was switched on the last time the engine was stopped.

Switching on/off manually



Press button briefly:

- ▶ The menu for the intelligent safety system is displayed. The systems are individually switched off according to their respective settings.

- ▶ LED lights up orange or goes out respective to their individual settings.

Adjust as needed. Individual settings are stored for the profile currently used.



Press button again:

- ▶ All Intelligent Safety systems are activated.
- ▶ The LED lights up green.



Hold down button:

- ▶ All Intelligent Safety systems are turned off.
- ▶ The LED goes out.

Display

Lamp in the exterior mirror housing

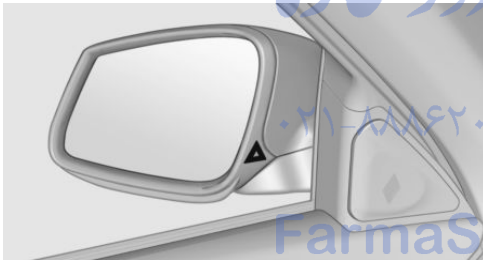

Information stage

The dimmed lamp in the exterior mirror housing indicates when there are vehicles in the blind spot or approaching from behind.

WARNING

If the turn signal is set while a vehicle is in the critical zone, the steering wheel vibrates briefly and the lamp in the exterior mirror housing flashes brightly.

The warning stops when the turn signal is switched off, or the other vehicle leaves the critical zone.

Brief flashing

A brief flashing of the lamp during vehicle unlocking serves as system self-test.

System limits

The system may not be fully functional in the following situations:

- ▶ When a vehicle is approaching at a speed much faster than your own.
- ▶ In heavy fog, rain or snowfall.
- ▶ In tight curves or on narrow lanes.
- ▶ If the bumper is dirty or iced up, or covered with stickers.

A Check Control message is displayed when the system is not fully functional.

For US owners only

The transmitter and receiver units comply with part 15 of the FCC/Federal Communication Commission regulations. Operation is governed by the following:

FCC ID:

- ▶ NBG009014A.

Compliance statement:

This device complies with part 15 of the FCC Rules. Operation is subject to the following two conditions:

- ▶ This device may not cause harmful interference, and
- ▶ this device must accept any interference received, including interference that may cause undesired operation.

Any unauthorized modifications or changes to these devices could void the user's authority to operate this equipment.

Brake force display

The concept



- ▷ During normal brake application, the bottom brake lights light up.
- ▷ During heavy brake application, the top brake lights light up in addition.

Active Protection

General information

The Active Protection safety package consists of systems that are independent of each other:

- ▷ Attentiveness assistant.
- ▷ PreCrash.
- ▷ PostCrash

Attentiveness assistant

The concept

The system can detect increasing lack of alertness or fatigue of the driver during long, monotonous journeys, e.g., on highways. In this situation, it is recommended that the driver takes a break.

Information



WARNING

The system does not relieve from the personal responsibility to correctly assess one's physical state. An increasing lack of alertness or fatigue may not be detected or not

be detected in time. There is risk of an accident. Make sure that the driver is rested and alert. Adjust the driving style to the traffic conditions. ◀

Function

The system is activated each time the engine is started and cannot be switched off.

After travel has begun, the system is trained about the driver, so that increasing lack of alertness or fatigue can be detected.

This procedure takes the following criteria into account:

- ▷ Personal driving style, e.g., steering behavior.
- ▷ Driving conditions, e.g., length of trip.

Starting at approximately 43 mph/70 km/h, the system is active and can display a recommendation to take a break.

Break recommendation

If the driver becomes increasingly less alert or fatigued, a message is displayed in the Control Display with the recommendation to take a break.

A recommendation to take a break is displayed only once during an uninterrupted trip.

After a break, another recommendation to take a break cannot be displayed until after approximately 45 minutes.

System limits

The function may be limited in the following situations, for instance, and will either output an incorrect warning or no warning at all:

- ▷ When the clock is set incorrectly.
- ▷ When the vehicle speed is mainly below about 43 mph/70 km/h.
- ▷ With a sporty driving style, such as during rapid acceleration or when cornering fast.
- ▷ In active driving situations, such as when changing lanes frequently.

- ▷ When the road surface is poor.
- ▷ In the event of strong side winds.

PreCrash

The concept

With this system critical driving situations that might result in an accident can be detected above a speed of approx. 20 mph/30 km/h. In these situations, preventive measures are automatically taken to minimize the risk of an accident as much as possible.

Critical driving situations may include:

- ▷ Emergency stop.
- ▷ Severe understeering.
- ▷ Severe oversteering.

If the vehicle includes the front-end collision warning or front-end collision warning with braking feature, impending collisions with vehicles driving ahead or stopped in front of you can also be detected within the system's range.

Information



WARNING

The system does not relieve from the personal responsibility. Due to the system limits, critical situation could not be detected reliably or in time. There is risk of an accident. Adjust the driving style to the traffic conditions. Watch traffic closely and actively interfere in the respective situations. ◀

Function

After the safety belt is buckled, the front belts are automatically pretensioned once after the vehicle is driven is away.

In critical driving situations, the following individual functions become active as needed:

- ▷ The front belts are automatically pretensioned.
- ▷ Automatic closing of the windows.

- ▷ Automatic closing of the glass sunroof.
- ▷ For vehicles equipped with Comfort Seats: automatic positioning of the backrest for the front passenger seat.

After a critical driving situation without an accident, the front belts are loosened again. All other systems can be restored to the desired setting.

If the belt tension does not loosen automatically, stop the vehicle and unbuckle the belt using the red button in the buckle. Fasten the belt before continuing on your trip.

PostCrash

In the event of an accident, the system can bring the car to a halt automatically without intervention by the driver in certain situations.

This can reduce the risk of a further collision and the consequences thereof.

Depressing the brake pedal can cause the vehicle to brake harder. This interrupts automatic braking. Destepping on the gas pedal also interrupts automatic braking.

After coming to a halt, the brake is released automatically. Secure the vehicle against rolling.

Driving stability control systems

Vehicle features and options

This chapter describes all standard, country-specific and optional features offered with the series. It also describes features that are not necessarily available in your car, e. g., due to the selected options or country versions. This also applies to safety-related functions and systems. The respectively applicable country provisions must be observed when using the respective features and systems.

Anti-lock Braking System ABS

ABS prevents locking of the wheels during braking.

The vehicle contains its steering power even during full brake applications, thus increasing active safety.

ABS is operational every time you start the engine.

Brake assistant

When you apply the brakes rapidly, this system automatically produces the greatest possible braking force boost. It reduces the braking distance to a minimum during emergency stop. This system utilizes all of the benefits provided by ABS.

Do not reduce the pressure on the brake pedal for the duration of the emergency stop.

Adaptive brake assistant

In combination with the Active Cruise Control, this system ensures that the brakes respond even more rapidly when braking in critical situations.

Drive-off assistant

This system supports driving off on inclines. The parking brake is not required.

1. Hold the vehicle in place with the foot brake.
2. Release the foot brake and drive off without delay.

After the foot brake is released, the vehicle is held in place for approx. 2 seconds.

Depending on the vehicle load or when a trailer is used, the vehicle may roll back slightly.

Automatic Differential Brake

The system controls the driving force by automatic braking intervention on individual wheels. The function corresponds to a differential lock: the system detects if a wheel begins to spin, because of loose road surface, e.g., and automatically brakes it.

The driving force is diverted to the wheel with better traction.

As a result, the engine force is transferred more efficiently to the wheels during accelerations.

Dynamic Performance Control DPC

The Dynamic Performance Control increases both the agility of the vehicle as well as the lane stability.

The system seamlessly handles the distribution of the drive torque between the two rear wheels.

Depending on the situation, the drive torque is shifted from the wheel on the inside of the

curve to the wheel on the outside of the curve or vice-versa.

To increase the maneuverability, the rear wheel on the outside of the curve is accelerated when the driving style is correspondingly sporty.

The steering responds directly; simultaneously, the understeering tendency of the four-wheel drive is reduced.

With the oversteering tendency, the system exerts a stabilizing effect by accelerating the rear wheel on the inside of the curve.

The system noticeably improves the traction and simultaneously increases the driving safety, especially on road surfaces having fluctuating coefficients of friction.

DSC Dynamic Stability Control

The concept

DSC prevents traction loss in the power wheels when driving off and accelerating.

DSC also recognizes unstable vehicle conditions such as fishtailing or nose-diving. Within the physical limits DSC helps to keep the vehicle on a steady course by reducing engine speed and by applying brakes to the individual wheels.

Information

Adapt your driving style to the situation, for an appropriate driving style is always the responsibility of the driver.

The laws of physics cannot be repealed, not even with DSC.

Therefore, do not reduce the additional safety margin by driving in a risky manner.



WARNING

When driving with roof load, e.g. with roof-mounted luggage rack, driving safety may not be ensured in driving-critical situations due

to the elevated center of gravity. There is risk of accidents or risk of property damage. Do not deactivate Dynamic Stability Control DSC when driving with roof load. ◀

Overview

Button in the vehicle



DSC OFF button

Indicator/warning lights



The indicator lamp flashes: DSC controls the drive and braking forces.

The indicator lamp lights up: DSC has failed.

Deactivating DSC: DSC OFF

When DSC is deactivated, driving stability is reduced during acceleration and when driving in curves.

To increase vehicle stability, activate DSC again as soon as possible.

Deactivating DSC



Press and hold this button but not longer than approx. 10 seconds, until the indicator lamp for DSC OFF lights up in the instrument cluster and displays DSC OFF.

The DSC system is switched off.

The steering and, depending on the equipment, suspension are tuned for sporty driving.

Activating DSC



Press button.

DSC OFF and the DSC OFF indicator lamp go out.

Indicator/warning lights

When DSC is deactivated, DSC OFF is displayed in the instrument cluster.



The indicator lamp lights up: DSC is deactivated.

DTC Dynamic Traction Control

The concept

The DTC system is a version of the DSC where forward momentum is optimized.

The system ensures maximum headway on special road conditions or loose road surfaces, e.g., unplowed snowy roads, but with somewhat limited driving stability.

Activating the Dynamic Traction Control DTC provides maximum traction. Driving stability is limited during acceleration and when driving in curves.

Therefore drive with appropriate caution.

You may find it useful to briefly activate DTC under the following special circumstances:

- ▷ When driving in slush or on uncleared, snow-covered roads.
- ▷ When freeing vehicle from deep snow or driving off from loose grounds.
- ▷ When driving with snow chains.

Deactivating/activating DTC Dynamic Traction Control

Activating DTC



Press button.

TRACTION is displayed in the instrument cluster and the indicator lamp for DSC OFF lights up.

Deactivating DTC



Press button again.

TRACTION and the DSC OFF indicator lamp go out.

Indicator/warning lights

If DTC is activated, TRACTION is displayed in the instrument cluster.



The indicator lamp lights up: DTC Dynamic Traction Control is activated.

xDrive

xDrive is the all-wheel-drive system of your vehicle. Concerted action by the xDrive and DSC further optimize traction and driving dynamics. The xDrive all-wheel-drive system variably distributes the drive forces to the front and rear axles as demanded by the driving situation and road surface.

Display on the Control Display

Displaying xDrive view

1. "Vehicle info"
2. "xDrive status"
3. "xDrive view"

The following information is displayed:

- ▷ With a navigation system: compass display for the driving direction
- ▷ Pitch attitude with degree and percentage
- ▷ Transverse gradient with degree indication
- ▷ Graphic display for the steering

Displaying distribution of the drive torque

1. "Vehicle info"
2. "xDrive status"
3.  "Torque distribution"

HDC Hill Descent Control

The concept

HDC is a downhill driving assistant that automatically controls vehicle speed on steep downhill gradients. Without applying the brakes, the vehicle moves at slightly more than walking speed.

Hill Descent Control can be activated at speeds below approx. 22 mph/35 km/h. When driving downhill, the vehicle reduces its speed to approx. walking speed and then keeps its speed constant.

As long as there is active braking, the system is on standby. The system does not brake the vehicle during this time.

Only use HDC in low gears or in selector lever position D or R.

Increasing or decreasing vehicle speed

Specify desired speed in the range from approx. 4 mph/6 km/h to approx. 15 mph/25 km/h using the rocker switch of the cruise control on the steering wheel. Vehicle speed can be changed by lightly accelerating.

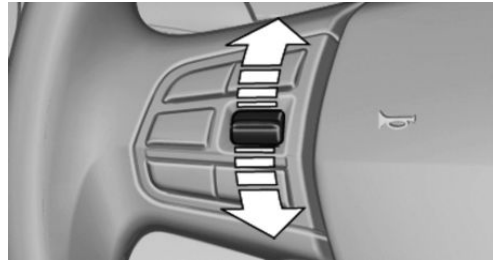

- ▷ Press the rocker switch up to the point of resistance: the speed increases gradually.
- ▷ Press up the rocker switch past the point of resistance: the speed increases while the rocker switch is pressed.
- ▷ Press the rocker switch down to the point of resistance: the speed decreases gradually.
- ▷ Press the rocker switch down past the point of resistance: when driving forward, the speed decreases to approx. 6 mph/10 km/h; when reversing, the speed decreases to approx. 4 mph/6 km/h.

Activating HDC



-  Press button; the LED above the button lights up.

Deactivating HDC

-  Press button again and the LED goes out. HDC is automatically deactivated above approx. 37 mph/60 km/h.

Display in the instrument cluster



The selected speed is displayed in the speedometer.

- ▷ Green: the system is actively braking the vehicle.
- ▷ Orange: the system is on standby.

Malfunction

A message is displayed in the instrument cluster. HDC is not available, e.g., due to elevated brake temperatures.

Active Steering

Active Steering varies the steering angle of the wheels in relation to the steering wheel movement as a function of the speed.

At lower speeds, for example during turning or maneuvering, the steering angle is increased, that is to say the steering becomes more direct.

At higher speeds, the steering angle is increasingly reduced.

This enables even more precise handling at high speeds and more responsive steering with reduced steering angle at low speeds.

Active roll stabilization

The concept

The system reduces the lateral inclination of the vehicle that occurs during rapid driving in curves or during quick evasive maneuvers.

Driving stability and driving comfort are increased under all driving conditions. The system utilizes active stabilizer bars on the front and rear axles that react immediately to all driving situations.

Programs

The system offers two different programs.

Select the programs via the Driving Dynamics Control, refer to page 139.

SPORT

Sporty tuning for greater driving agility.

COMFORT

Comfort-oriented tuning for optimal comfort.

Vertical Dynamic Control

The concept

This system reduces undesirable vehicle motion when using a dynamic driving style or traveling on uneven road surfaces.

The system enhances driving dynamics and comfort fitting road surface and driving style.

Programs

The system offers several different programs.

Select the programs via the Driving Dynamics Control, refer to page 139.

SPORT/SPORT+

Consistently sporty control of the shock absorbers for greater driving agility.

COMFORT/ECO PRO

Balanced tuning.

Self-leveling suspension

The concept

The self-leveling suspension keeps the vehicle height and ground clearance constant. The height of the vehicle at the rear axle is maintained at a predefined level under all load conditions.

The system ensures consistent comfort by keeping spring travel constant in all driving situations.

Malfunction

A Check Control message is displayed. The system is disrupted. Vehicle handling may be altered and driving comfort may be noticeably reduced. Visit the nearest dealer's service center or another qualified service center or repair shop.

Driving Dynamics Control

The concept



The Driving Dynamics Control can be used to adjust the driving dynamics of the vehicle. For this purpose various programs are available for selection that are activated via the two buttons of the Driving Dynamics Control and the DSC OFF-button.

Overview

Button in the vehicle



Operating the programs

Press button	Program
	DSC OFF TRACTION
	SPORT+ SPORT COMFORT ECO PRO

Automatic program change

The system may automatically switch to COMFORT in the following situations:

- ▷ Failure of DSC Dynamic Stability Control.
- ▷ The vehicle has a flat tire.
- ▷ When activating cruise control in TRACTION or DSC OFF mode.

DSC OFF

Driving stability is limited during acceleration and when driving in curves.

To increase vehicle stability, activate DSC again as soon as possible.

Deactivating DSC: DSC OFF



Press and hold this button but not longer than approx. 10 seconds, until the indicator lamp for DSC OFF lights up in the instrument cluster and displays DSC OFF.

The DSC system is switched off.

Activating DSC



Press button.
DSC OFF and the DSC OFF indicator lamp go out.

Indicator/warning lights

When DSC OFF is activated, DSC OFF is displayed in the instrument cluster.



The indicator lamp lights up: DSC OFF is activated.

TRACTION

Maximum traction on loose road surfaces. DTC Dynamic Traction Control is switched on. Driving stability is limited during acceleration and when driving in curves.

Activating TRACTION



Press button.

TRACTION is displayed in the instrument cluster and the indicator lamp for DSC OFF lights up.

Deactivating TRACTION



Press button again.

TRACTION and the DSC OFF indicator lamp go out.

Indicator/warning lights

If TRACTION is activated, TRACTION is displayed in the instrument cluster.



The indicator lamp lights up: TRACTION is activated.

SPORT+

Sporty driving with optimized suspension and adapted engine control with limited driving stabilization.

Dynamic Traction Control is switched on.

The driver handles several of the stabilization tasks.

Activating SPORT+



Press button repeatedly until SPORT+ appears in the instrument cluster and the DSC OFF indicator lamp lights up.

Automatic program change

When switching on the manual speed limiter or activating cruise control, the program automatically switches to SPORT mode.

Indicator/warning lights

SPORT+ is displayed in the instrument cluster.



The DSC OFF indicator lamp lights up: Dynamic Traction Control is activated.

SPORT

Consistently sporty tuning of the suspension and engine control for greater driving agility with maximum driving stabilization.

The program can be configured to individual specifications.

The configuration is stored for the profile currently used.

Activating SPORT



Press button repeatedly until SPORT is displayed in the instrument cluster.

COMFORT

For a balanced tuning with maximum driving stabilization.

Activating COMFORT



Press button repeatedly until COMFORT is displayed in the instrument cluster.

In certain situations, the system automatically changes to the NORMAL program, automatic program change, refer to page 139.

ECO PRO

ECO PRO, refer to page 196, provides consistent tuning to minimize fuel consumption for maximum range with maximum driving stabilization.

Comfort functions and the engine controller are adjusted.

The program can be configured to individual specifications.

Activating ECO PRO



Press button repeatedly until ECO PRO is displayed in the instrument cluster.

Configuring ECO PRO

1. Activate ECO PRO.
2. "Configure ECO PRO"

Make the desired settings.

Displays in the instrument cluster

Selected program



The instrument cluster displays the selected program.

Program selection

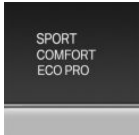

Pressing the button displays a list of the selectable programs. Depending on your vehicle's optional features, the list in the instrument cluster can differ from the illustration shown.

Display on the Control Display

Program changes can be displayed briefly on the Control Display.

To do so, make the following settings:

1. "Settings"
2. "Control display"
3. "Driving mode info"

Driving comfort

Vehicle features and options

This chapter describes all standard, country-specific and optional features offered with the series. It also describes features that are not necessarily available in your car, e. g., due to the selected options or country versions. This also applies to safety-related functions and systems. The respectively applicable country provisions must be observed when using the respective features and systems.

Active Cruise Control with Stop & Go function, ACC

The concept

Use this system to select a desired speed that the vehicle will maintain automatically on clear roads.

To the extent possible, the system automatically adjusts the speed to a slower vehicle ahead of you.

The distance that the vehicle maintains to the vehicle ahead of you can be varied.

For safety reasons, it depends on the speed.

To maintain a certain distance, the system automatically reduces the speed, applies the brakes lightly, or accelerates again if the vehicle ahead begins moving faster.

If the vehicle ahead of you brakes to a halt, and then proceeds to drive again within a brief period, the system is able to detect this within the given system limits. Your own vehicle will brake automatically and then accelerate again.

If the vehicle ahead of you drives away again after a prolonged period, briefly press the accelerator pedal or press the appropriate button to reactivate the system. The vehicle will automatically accelerate.

As soon as the road is clear, the vehicle accelerates to the desired speed.

The speed is also maintained downhill, but may not be maintained uphill if engine power is insufficient.

General information

Depending on the driving settings, the features of the cruise control can change in certain areas.

Information



WARNING

The system does not relieve from the personal responsibility to correctly assess the traffic situation. Based on the limits of the system, it cannot independently react to all traffic situations. There is risk of an accident. Adjust the driving style to the traffic conditions. Watch traffic closely and actively interfere in the respective situations. ◀



WARNING







An unsecured vehicle can put itself into motion and roll away. There is risk of an accident. Before exiting, secure the vehicle against rolling.

In order to ensure that the vehicle is secured against rolling away, observe the following:

- ▶ Set the parking brake.
- ▶ On uphill grades or on a slope, turn the front wheels in the direction of the curb.
- ▶ On uphill grades or on a slope, also secure the vehicle, e.g. with a wheel chock. ◀

Overview

Buttons on the steering wheel

Press button	Function
	Cruise control on/off, interrupt, refer to page 143
	Store/maintain speed, refer to page 144
	Resume speed, refer to page 145
	Reduce distance, refer to page 145
	Increase distance, refer to page 145
	Rocker switch: Maintain, store, change speed, refer to page 144

Buttons are arranged according to vehicle's series, optional features and country specifications.

Radar sensor

A radar sensor is located in the front bumper for detecting vehicles on the road ahead of the vehicle.

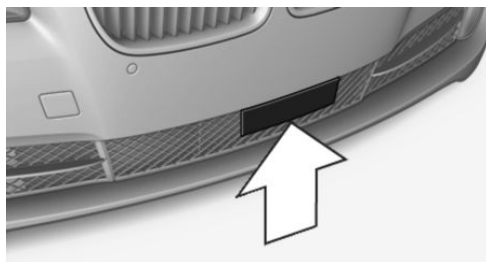

Always keep radar sensor clean and unobstructed.

Camera

A camera serves to detect vehicles.

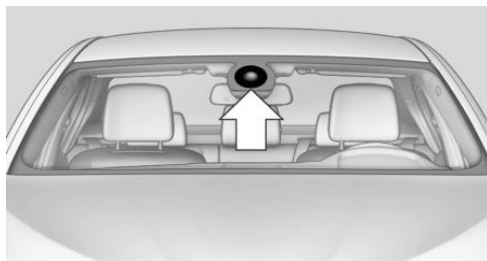

The camera is installed near the interior rearview mirror.

Keep the windshield in the area behind the interior rearview mirror clean and clear.

Switching on/off and interrupting cruise control

Switching on



Press button on the steering wheel.

The indicator lights in the instrument cluster light up and the mark in the speedometer is set to the current speed.

Cruise control can be used.

DSC Dynamic Stability Control will be switched on if needed.

Switch off

To switch off the system while standing, step on brake pedal at the same time.



Press button on the steering wheel.

- ▷ If active: press twice.
- ▷ If interrupted: press once.

The displays go out. The stored desired speed is deleted.

Interrupting



Press button on the steering wheel.

If interrupting the system while stationary, press on the brake pedal at the same time.

The system is automatically interrupted in the following situations:

- ▷ When the brakes are applied.
- ▷ When selector lever position D is disengaged.
- ▷ When DTC Dynamic Traction Control is activated or DSC is deactivated.
- ▷ When DSC is actively controlling stability.
- ▷ When SPORT+ is activated with Driving Dynamics Control.
- ▷ If the safety belt and the driver's door are opened while the vehicle is standing still.
- ▷ If the system has not detected objects for an extended period, e.g., on a road with very little traffic without curb or shoulder markings.
- ▷ If the detection range of the radar is disrupted, e.g., by dirt or heavy fog.
- ▷ After a longer stationary period when the vehicle has been braked to a stop by the system.

Maintaining, storing, and changing the speed

Information

WARNING

The desired speed can be incorrectly adjusted or called up by mistake. There is risk of an accident. Adjust the desired speed to the traffic conditions. Watch traffic closely and actively interfere in the respective situations. ◀

WARNING

Risk of accident due to too high speed differences to other vehicles, e.g. in the following situations:

- ▷ When fast approaching a slowly moving vehicle.

- ▷ Suddenly swerving vehicle onto the own lane.
- ▷ When fast approaching standing vehicles.

There is risk of injuries or danger to life. Watch traffic closely and actively interfere in the respective situations. ◀

Maintaining/storing the speed

SET

Press button.

Or:

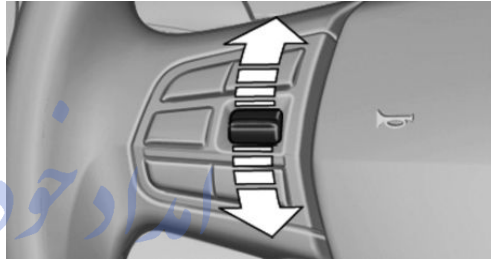

Press the rocker switch while the system is interrupted.

When the system is switched on, the current speed is maintained and stored as the desired speed.

This is displayed in the speedometer and briefly in the instrument cluster, refer to page 145.

DSC Dynamic Stability Control will be switched on if needed.

Changing the speed

Press the rocker switch up or down repeatedly until the desired speed is set.

If active, the displayed speed is stored and the vehicle reaches the stored speed when the road is clear.

- ▷ Each time the rocker switch is pressed to the point of resistance, the desired speed increases or decreases by approx. 1 mph/1 km/h.

- ▷ Each time the rocker switch is pressed past the point of resistance, the desired speed increases or decreases by a maximum of 5 mph/10 km/h.

Hold the rocker switch in position to repeat the action.

Distance



WARNING

The system does not relieve from the personal responsibility. Due to the system limits, braking can be late. There is risk of accidents or risk of property damage. Be aware to the traffic situation at all times. Adjust the distance to the traffic and weather conditions and maintain the prescribed safety distance, possibly by braking. ◀

Reduce distance



Press button repeatedly until the desired distance is set.

Instrument cluster will display selected distance, refer to page 146.

Increase distance



Press button repeatedly until the desired distance is set.

Instrument cluster will display selected distance, refer to page 146.

Calling up the desired speed and distance

While driving



Press button with the system switched on.

In the following cases, the stored speed value is deleted and cannot be called up again:

- ▷ When the system is switched off.
- ▷ When the ignition is switched off.

While standing

The system brought the vehicle to a complete standstill:

- ▷ Green marking in the speedometer:
Your vehicle accelerates automatically as soon as the vehicle in the range of the radar sensor moves off.
- ▷ Speedometer markings turn orange: no automatic driving off.
To accelerate to the desired speed automatically, press the accelerator or press the RES or SET button.

Rolling bars in the distance display indicate that the vehicle detected by the radar sensor has driven off.

The system was paused or your vehicle was brought to a halt actively through stepping on the brake pedal and it is standing behind another vehicle:

1.  Press button to call up a stored desired speed.
2. Release the brake pedal.
3. Step on the accelerator briefly, or press the RES rocker switch when the vehicle ahead of you drives away.

Displays in the instrument cluster

Desired speed



- ▷ The marking lights up green: the system is active.
- ▷ The marking lights up orange: the system has been interrupted.
- ▷ The marking does not light up: the system is switched off.



With instrument display: the symbol is displayed in the speedometer similarly to the mark for the desired speed.

Brief status display



Selected desired speed.

If no speed is indicated, it is possible that the conditions necessary for operation are not currently fulfilled.

Distance to vehicle ahead of you

Shown is selected distance to the vehicle driving ahead of you.

Distance display



Distance 1



Distance 2



Distance 3



Distance 4

This value is set automatically after the system is switched on.



The system has been interrupted or distance control is temporarily suppressed because the accelerator pedal is being pressed; a vehicle was not detected.



Distance control is temporarily suppressed because the accelerator pedal is being pressed; a vehicle was detected.

Rolling bars: the detected vehicle has driven away.

ACC is no longer accelerating. To accelerate further, activate ACC by briefly stepping on the accelerator pedal, pressing the RES button or rocker switch.

Indicator/warning lights



Symbol lights up orange:

A vehicle has been detected ahead of you.



Symbol flashes orange:

The conditions are not adequate for the system to work.

The system was deactivated but applies the brakes until you actively resume control by pressing on the brake pedal or accelerator pedal.



Symbol flashes red and a signal sounds:

You are requested to intervene by braking or make an evasive maneuver.

Displays in the Head-up Display

Some information can also be displayed in the Head-up Display.

Distance information



The symbol is displayed when the distance from the vehicle traveling ahead is too short.

The distance information is active under the following circumstances:

- ▶ Active Cruise Control switched off.
- ▶ Display in the Head-up Display selected, refer to page 98.
- ▶ Distance too short.
- ▶ Speed greater than approx. 40 mph/70 km/h.

System limits

Speed range

The system is best used on well-constructed roads.

The minimum speed that can be set is 20 mph/30 km/h. The maximum speed that can be set depends on the vehicle.

The system can also be activated when stationary.

Comply with the legal speed limit in every situation when using the system.

Detection range

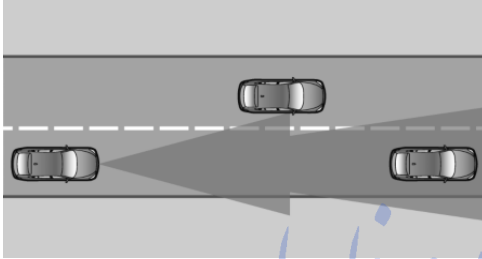

The detection capacity of the system and the automatic braking capacity are limited.

Two-wheeled vehicles for instance might not be detected.

Deceleration

The system also does not decelerate in the following situations:

- ▶ For pedestrians or similar slow-moving road users.
- ▶ For red traffic lights.
- ▶ For cross traffic.
- ▶ For oncoming traffic.

Swerving vehicles

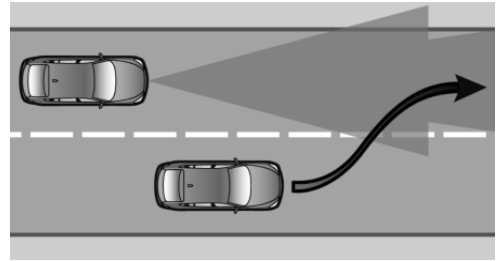

A vehicle driving in front of you is not detected until it is completely within the same lane as your vehicle.

If a vehicle driving ahead of you suddenly swerves into your lane, the system may not be able to automatically restore the selected distance. This also applies to major speed differences to vehicles driving ahead of you, e.g., when rapidly approaching a truck. When a vehicle driving ahead of you is reliably detected, the system requests that the driver intervene by braking and carrying out evasive maneuvers, if needed.



WARNING

The system does not relieve from the personal responsibility to correctly assess the traffic situation. Based on the limits of the system, it cannot independently react to all traffic situations. There is risk of an accident. Adjust the driving style to the traffic conditions. Watch traffic closely and actively interfere in the respective situations. ◀

Cornering

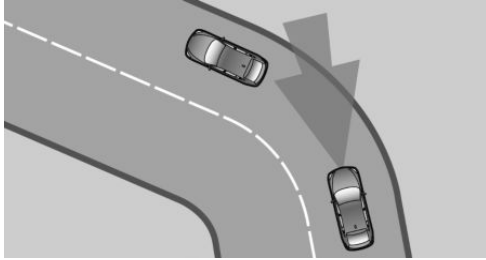

If the desired speed is too high for a curve, the speed is reduced slightly, although curves cannot be anticipated in advance. Therefore, drive into a curve at an appropriate speed.

In tight curves the system offers only restricted detection where a vehicle ahead of you might be detected late or not at all.



When you approach a curve the system may briefly report vehicles in the next lane due to the bend of the curve. If the system decelerates you may compensate it by briefly accelerating.

After releasing the gas pedal the system is reactivated and controls speed independently.

Driving away

In some situations, the vehicle cannot drive off automatically; for example:

- ▷ On steep inclines.
- ▷ From behind bumps in the road.

In these cases, step on the accelerator pedal.

Weather

In the event of unfavorable weather and light conditions, e. g. if there is rain, snowfall, slush, fog or glare, this may result in poorer recognition of vehicles as well as short-term interruptions for vehicles that are already detected. Drive attentively, and react to the current traffic situation. If necessary, intervene actively, e.g. by braking, steering or evading.

Malfuction

The system cannot be activated if the radar sensor is not aligned correctly. This may be caused by damage incurred during parking, e.g.

A Check Control message is displayed if the system fails.

The function for detecting and responding when approaching stationary vehicles may be limited in the following situations:

- ▷ During calibration of the camera immediately after vehicle delivery.
- ▷ If the camera is malfunctioning or dirty. A Check Control message is displayed.

Cruise control

The concept

The system maintains a preset speed via the buttons on the steering wheel. The system brakes on downhill gradients if engine braking is insufficient.

General information

Depending on the driving settings, the features of the cruise control can change in certain areas.

Information



WARNING





The use of the system can lead to an increased risk of accidents in the following situations:

- ▷ On winding roads.
- ▷ In heavy traffic.
- ▷ On slippery roads, in fog, snow or rain, or on a loose road surface.

There is risk of accidents or risk of property damage. Only use the system if driving at constant speed is possible. ◀

Overview

Buttons on the steering wheel

Press button	Function
	Cruise control on/off, interrupt, refer to page 149
	Store/maintain speed, refer to page 150
	Resume speed, refer to page 150
	Rocker switch: Maintain, store, change speed, refer to page 150

Controls

Switching on



Press button on the steering wheel.

The marking in the speedometer is set to the current speed.

The cruise control can be used.

DSC Dynamic Stability Control will be switched on if needed.

Switch off



WARNING

The system does not relieve from the personal responsibility to correctly assess the traffic situation. Based on the limits of the system, it cannot independently react to all traffic situations. There is risk of an accident. Adjust the driving style to the traffic conditions. Watch traffic closely and actively interfere in the respective situations. ◀



Press button on the steering wheel.

- ▷ If active: press twice.
- ▷ If interrupted: press once.

The displays go out. The stored desired speed is deleted.

Interrupting



When active, press the button.

The system is automatically interrupted in the following situations:

- ▷ When the brakes are applied.
- ▷ If selector lever position D is disengaged.
- ▷ If DTC Dynamic Traction Control is activated or DSC is deactivated.
- ▷ When DSC is actively controlling stability.
- ▷ If HDC is activated.
- ▷ When SPORT+ is activated with Driving Dynamics Control.

Maintaining, storing, and changing the speed

Information



WARNING

The desired speed can be incorrectly adjusted or called up by mistake. There is risk of an accident. Adjust the desired speed to the traffic conditions. Watch traffic closely and actively interfere in the respective situations. ◀

Maintaining/storing the speed

SET

Press button.

Or:

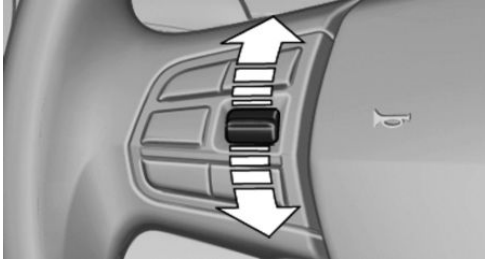

Press the rocker switch while the system is interrupted.

When the system is switched on, the current speed is maintained and stored as the desired speed.

This is displayed, refer to page 150, in the speedometer and briefly in the instrument cluster.

DSC Dynamic Stability Control will be switched on if needed.

Changing the speed

Press the rocker switch up or down repeatedly until the desired speed is set.

If active, the displayed speed is stored and the vehicle reaches the stored speed when the road is clear.

- ▷ Each time the rocker switch is pressed to the point of resistance, the desired speed increases or decreases by approx. 1 mph/1 km/h.
- ▷ Each time the rocker switch is pressed past the point of resistance, the desired speed increases or decreases by a maximum of 5 mph/10 km/h.
The maximum speed that can be set depends on the vehicle.
- ▷ Pressing the rocker switch to the resistance point and holding it accelerates or de-

celerates the vehicle without requiring pressure on the accelerator pedal.

After the rocker switch is released, the vehicle maintains its final speed. Pressing the switch beyond the resistance point causes the vehicle to accelerate more rapidly.

Resuming the desired speed

RES

Press button.

The stored speed is reached and maintained.

Displays in the instrument cluster

Indicator lamp



Depending on how the vehicle is equipped, the indicator lamp in the instrument cluster indicates whether the system is switched on.

Desired speed

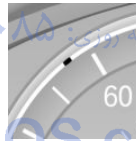

- ▷ The marking lights up green: the system is active.
- ▷ The marking lights up orange: the system has been interrupted.
- ▷ The marking does not light up: the system is switched off.



With instrument display: the symbol is displayed in the speedometer similarly to the mark for the desired speed.

Brief status display



Selected desired speed.

If no speed is indicated, it is possible that the conditions necessary for operation are not currently fulfilled.

Displays in the Head-up Display

Some system information can also be displayed in the Head-up Display.

PDC Park Distance Control

The concept

PDC is a support when parking. When you slowly approach an object in the rear - or also in the front of the vehicle if the feature is available - then the object is reported through:

- ▷ Signal tones.
- ▷ Visual display.

General information

Ultrasound sensors in the bumpers measure the distances from objects.

The maneuvering range, depending on the obstacle and environmental conditions, is approx. 6 ft/2 m.

An acoustic warning is first given with the following circumstances:

- ▷ By the front sensors and the two rear corner sensors at approx. 24 in/60 cm.
- ▷ By the rear middle sensors at approx. 5 ft/1.50 m.
- ▷ When a collision is imminent.

Information



WARNING

The system does not relieve from the personal responsibility to correctly assess the traffic situation. Based on the limits of the system, it cannot independently react to all traffic situations. There is risk of an accident. Adjust the driving style to the traffic conditions. Watch traffic closely and actively interfere in the respective situations. ◀



WARNING

Due to high speeds when PDC is activated, the warning can be delayed due to physical circumstances. There is risk of injuries or risk of property damage. Avoid approaching an object too fast. Avoid driving off fast while PDC is not yet active. ◀

Overview

With front PDC: button in vehicle



PDC Park Distance Control

Ultrasound sensors



PDC sensors on the vehicle.

Functional requirements

To ensure full functionality:

- ▷ Do not cover sensors, e.g., with stickers, bicycle racks.
- ▷ Keep the sensors clean and free of ice.

To clean: when using high-pressure washers, do not spray the sensors for long periods and maintain a distance of at least 12 in/30 cm.

Switching on/off

Switching on automatically

PDC switches on automatically in the following situations:

- ▷ If selector lever position R is engaged when the engine is running.
The rearview camera also switches on.
- ▷ If equipped with front PDC: when obstacles are detected behind or in front of the vehicle by PDC and the speed is slower than approx. 2.5 mph/4 km/h.

You may turn off automatic activation:

1. "Settings"
2. "Parking"
3. Select setting.

Settings are stored for the profile currently used.

Automatic deactivation during forward travel

The system switches off when a certain driving distance or speed is exceeded.

Switch the system back on if needed.

With front PDC: switching on/off manually

 Press button.

- ▷ On: the LED lights up.
- ▷ Off: the LED goes out.

The rearview camera image is displayed when the reverse gear is engaged by pressing the button.

Display

Signal tones

When approaching an object, an intermittent sound indicates the position of the object. E. g. if an object is detected to the left rear of the

vehicle, a signal tone sounds from the left rear speaker.

The shorter the distance to the object, the shorter the intervals.

If the distance to a detected object is less than approx. 10 in/25 cm, a continuous tone is sounded.

With front PDC: if objects are located both in front of and behind the vehicle, an alternating continuous signal is sounded.

The signal tone is switched off, when selector lever position P is engaged on vehicles with Steptronic transmission.

Volume

The ratio of the PDC signal tone volume to the entertainment volume can be adjusted.

1. "Multimedia", "Radio" or "Settings"
2. "Tone"
3. "Volume settings"
4. "PDC"
5. Turn the controller until the desired setting is selected.
6. Press the controller.

Settings are stored for the profile currently used.

Visual warning

The approach of the vehicle to an object can be shown on the Control Display. Objects that are farther away are already displayed on the Control Display before a signal sounds.

A display appears as soon as Park Distance Control (PDC) is activated.

The range of the sensors is represented in the colors green, yellow and red.

When the image of the rearview camera is displayed, the switch can be made to PDC:

 "Rear view camera"

System limits

Limits of ultrasonic measurement

Ultrasonic measuring might not function under the following circumstances:

- ▷ For small children and animals.
- ▷ For persons with certain clothing, e.g. coats.
- ▷ With external interference of the ultrasound, e.g. from passing vehicles or loud machines.
- ▷ When sensors are dirty, iced over, damaged or out of position.
- ▷ Under certain weather conditions such as high relative humidity, rain, snowfall, extreme heat or strong wind.
- ▷ With tow bars and trailer couplings of other vehicles.
- ▷ With thin or wedge-shaped objects.
- ▷ With moving objects.
- ▷ With elevated, protruding objects such as ledges or cargo.
- ▷ With objects with corners and sharp edges.
- ▷ With objects with a fine surface structure such as fences.
- ▷ For objects with porous surfaces.

Low objects already displayed, e.g., curbs, can move into the blind area of the sensors before or after a continuous tone sounds.

False warnings

PDC may issue a warning under the following conditions even though there is no obstacle within the detection range:

- ▷ In heavy rain.
- ▷ When sensors are very dirty or covered with ice.
- ▷ When sensors are covered in snow.
- ▷ On rough road surfaces.
- ▷ On uneven surfaces, such as speed bumps.

- ▷ In large buildings with right angles and smooth walls, e.g., in underground garages.
- ▷ In automatic car washes.
- ▷ Through heavy pollution.
- ▷ Due to other ultrasound sources, e.g., sweeping machines, high pressure steam cleaners or neon lights.

Malfunction

A Check Control message is displayed.

The range of the sensors is shown as a shaded area on the Control Display.

PDC has failed. Have the system checked.

Surround View

The concept

Surround View comprises various camera assistance systems that help the driver when parking, maneuvering, and at complex exits and intersections.

- ▷ Rearview camera, refer to page 153.
- ▷ Top View, refer to page 156.
- ▷ Side View, refer to page 158.

Rearview camera

The concept

The rearview camera provides assistance in parking and maneuvering backwards. The area behind the vehicle is shown on the Control Display.

Information



WARNING

The system does not relieve from the personal responsibility to correctly assess the traffic situation. There is risk of an accident. Adjust the driving style to the traffic condi-

tions. Watch traffic and vehicle surroundings closely and actively interfere in the respective situations. ◀

Overview

Button in the vehicle



 Rearview camera

Camera

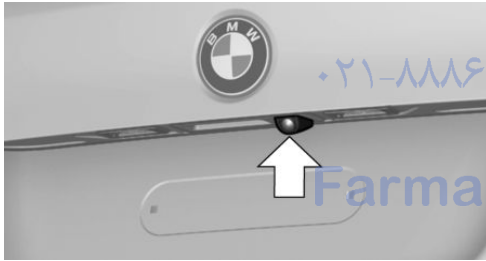

The camera lens is located in the handle of the tailgate. The image quality may be impaired by dirt.

Clean the camera lens, refer to page 246.

Switching on/off

Switching on automatically

With the engine running, engage lever in position P R.

Automatic deactivation during forward travel

The system switches off when a certain driving distance or speed is exceeded.

Switch the system back on if needed.

Switching on/off manually

 Press button.

- ▷ On: the LED lights up.
- ▷ Off: the LED goes out.

The PDC is shown on the Control Display.

The rearview camera image is displayed when the reverse gear is engaged by pressing the button.

Switching the view via iDrive

With PDC activated or Top View switched on:

 "Rear view camera"

The rearview camera image is displayed.



Display on the Control Display

Functional requirement

- ▷ The rearview camera is switched on.
- ▷ The tailgate is fully closed.

Activating assistance functions

More than one assistance function can be active at the same time.

- ▷ Parking aid lines
 -  "Parking aid lines"
 - Lanes and turning radius are indicated.
- ▷ Obstacle marking
 -  "Obstacle marking"
 - Spatially-shaped markings are displayed.

Pathway lines

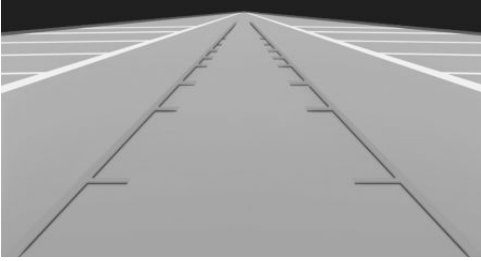

Pathway lines can be superimposed on the image of the rearview camera.

Pathway lines help you to estimate the space required when parking and maneuvering on level roads.

Pathway lines depend on the current steering angle and are continuously adjusted to the steering wheel movements.

Turning circle lines

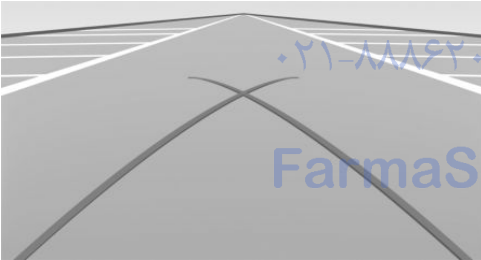

Turning circle lines can only be superimposed on the rearview camera image together with pathway lines.

Turning circle lines show the course of the smallest possible turning radius on a level road.

Only one turning radius line is displayed after the steering wheel is turned past a certain angle.

Obstacle marking

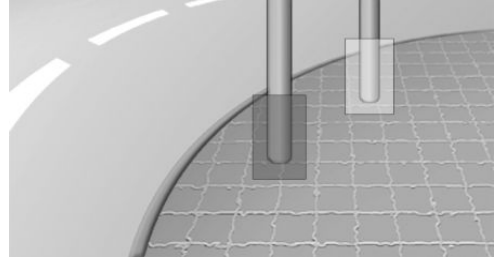

Obstacles behind the vehicle are detected by the PDC sensors and, when respectively equipped, detected by the rearview camera.

Obstacle markings can be faded into the image of the rearview camera.

Their colored margins of the obstacle markings match the markings of the PDC.

Parking using pathway and turning radius lines

1. Position the vehicle so that the turning radius lines lead to within the limits of the parking space.

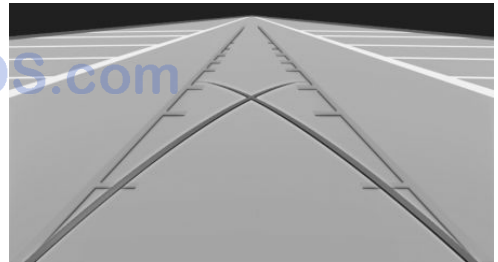

- Turn the steering wheel to the point where the pathway line covers the corresponding turning radius line.

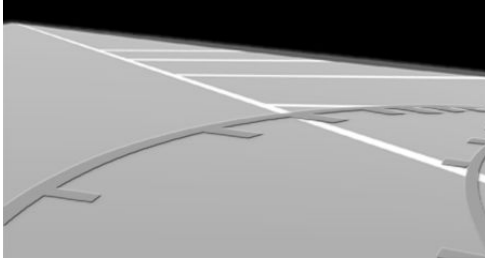

Display settings

Brightness

With the rearview camera switched on:

-  Select the symbol.
- Turn the controller until the desired setting is reached, and press the controller.

Contrast

With the rearview camera switched on:

-  Select the symbol.
- Turn the controller until the desired setting is reached, and press the controller.

System limits

Detection of objects

Very low obstacles as well as high, protruding objects such as ledges may not be detected by the system.

Assistance functions also take into account data of the PDC.

Follow instructions in the PDC chapter, refer to page 151.

The objects displayed on the Control Display under certain circumstances are closer than they appear. Do not estimate the distance from the objects on the display.

Top View

The concept

Top View provides assistance in parking and maneuvering. The area around the vehicle is shown on the Control Display.

General information

The image is captured by two cameras integrated in the exterior mirrors, by the rear-view camera and a camera on the front of the vehicle.

The range is no more than approx. 6.5 ft/2 m to the side, front and rear.

Obstacles within this range are thus displayed early on the Control Display.

Information



WARNING

The system does not relieve from the personal responsibility to correctly assess the traffic situation. There is risk of an accident. Adjust the driving style to the traffic conditions. Watch traffic and vehicle surroundings closely and actively interfere in the respective situations. ◀

Overview

Button in the vehicle



Top View

Cameras

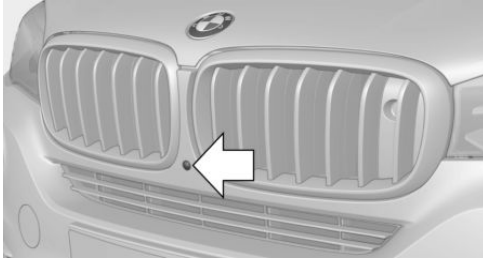

Front camera

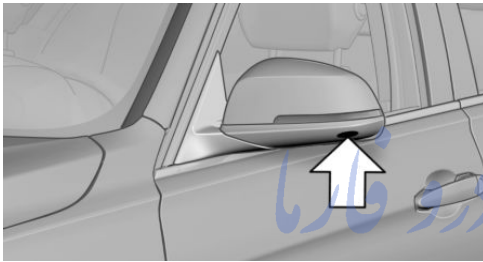

The lenses of the Top View cameras are located at the bottom of the exterior mirror housings. The image quality may be impaired by dirt.

Clean the camera lenses, refer to page 246.

Functional requirements

Top View can be used only to a limited extent in the following situations:

- ▷ With a door open.
- ▷ With the tailgate open.
- ▷ With an exterior mirror folded in.
- ▷ In poor light.

The unavailable camera range is depicted by shading.

Switching on/off

Switching on automatically

With the engine running, engage lever in position P R.

The rearview camera image is displayed. To switch to the Top View:

☞ "Rear view camera"

Automatic deactivation during forward travel

The system switches off when a certain driving distance or speed is exceeded.

Switch the system back on if needed.

Switching on/off manually



Press button.

- ▷ On: the LED lights up.
- ▷ Off: the LED goes out.

Top View is displayed.

The rearview camera image is displayed when the reverse gear is engaged by pressing the button.

Display

Display on the Control Display

The area surrounding the vehicle can be displayed on the Control Display.

The display appears as soon as Top View is activated.

When the image of the rearview camera is displayed, it is possible to switch to top view:

☞ "Rear view camera"

Brightness

With Top View switched on:

1. ☀ Select the symbol.
2. Turn the controller until the desired setting is reached, and press the controller.

Contrast

With Top View switched on:

1. ● Select the symbol.

- Turn the controller until the desired setting is reached, and press the controller.

Displaying the turning radius and pathway lines

- The static, red turning radius line shows the space needed to the side of the vehicle when the steering wheel is turned all the way.
- The variable, green pathway line assists you in assessing the amount of space actually needed to the side of the vehicle. The lane line depends on the engaged gear and the current steering angle. The track line is continuously adjusted for the steering wheel movement.

"Parking aid lines"

Turning circle and pathway lines are displayed.

System limits

A Check Control message is displayed when a camera is not working.

Side View

The concept

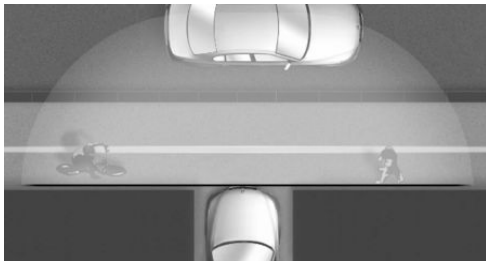

Side View provides an early look at cross traffic at blind driveways and intersections. Road users concealed by obstacles to the left and right of the vehicle can only be detected relatively late from the driver's seat. To improve the viewing, each camera, front and rear on the vehicle, detects the traffic area on the side.

Which camera is active is shown on the top edge of the screen.

Information

The images of the cameras are displayed, depending on the gear selected, on the Control Display.



WARNING

The system does not relieve from the personal responsibility to correctly assess the traffic situation. There is risk of an accident. Adjust the driving style to the traffic conditions. Watch traffic and vehicle surroundings closely and actively interfere in the respective situations. ◀

Overview

Button in the vehicle



Side View

Cameras

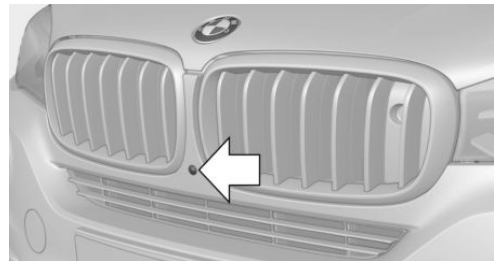

Front camera

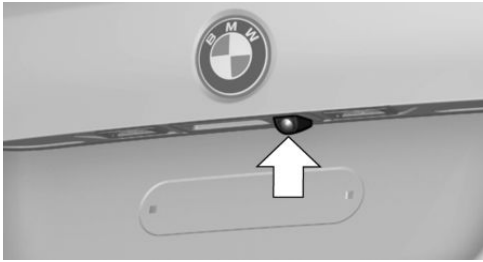

Rear camera

Two cameras are used for the detection.
The image quality may be impaired by dirt.
Clean the camera lenses, refer to page 246.

Switching on/off

Switching on/off manually



Press button.

Depending on the transmission position, the picture of the front or rear camera is displayed.

Switching off automatically

By switching into a different function or when changing gears.

Front Side View: when a certain driving distance or speed is exceeded.

Display

General information

The traffic area in front of or behind the vehicle is displayed on the Control Display.

Brightness

With the Side View switched on:

1. ☀ Select the symbol.
2. Turn the controller until the desired setting is reached, and press the controller.

Contrast

With the Side View switched on:

1. ● Select the symbol.
2. Turn the controller until the desired setting is reached, and press the controller.

Warning of crossing traffic

The concept

When an object approaching from the side is detected by the front or rear camera, this is depicted by a symbol in the Side View display.

Requirements

- ▷ Side View switched on.
- ▷ Your vehicle moves no faster than walking speed.
- ▷ To detect approaching objects, sufficient brightness, e.g., daylight is necessary.

Display



The yellow symbol is displayed if an approaching vehicle is detected by the camera.



A gray symbol is displayed if crossing traffic cannot be detected.

System limits

In the following situations, the warning about crossing traffic may be limited:

- ▷ In poor lighting or visibility conditions.
- ▷ If the camera is soiled or covered.

System limits

The objects displayed on the Control Display under certain circumstances are closer than they appear. Therefore, do not estimate the distance from the objects on the display.

The viewing angle is approx. 180°.

Parking assistant

The concept

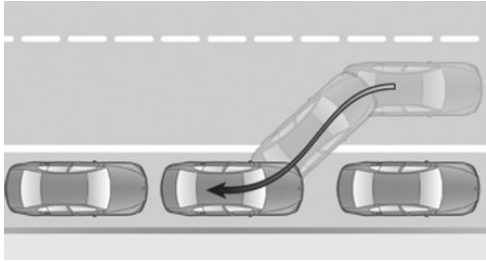

This system assists the driver in parking parallel to the road.

Ultrasound sensors measure parking spaces on both sides of the vehicle.

The parking assistant calculates the best possible parking line and during the parking procedure takes control of steering, the acceleration and braking and if needed changes the gears. Hold down the parking assistant button for the duration of the parking procedure. At the end of the parking procedure, the P selector lever position is set.

When parking, also take note of the visual and acoustic information and instructions issued by the PDC, the parking assistant and the rear-view camera and react accordingly.

A component of the parking assistant is the PDC Park Distance Control, refer to page 151.

Information



WARNING

The system does not relieve from the personal responsibility to correctly assess the traffic situation. Based on the limits of the system, it cannot independently react to all traffic situations. There is risk of an accident. Adjust the driving style to the traffic conditions. Watch traffic closely and actively interfere in the respective situations. ◀



CAUTION

The parking assistant can steer the vehicle over or onto curbs. There is risk of property damage. Watch traffic closely and actively interfere in the respective situations. ◀

An engine that has been switched off by the Auto Start Stop function is restarted automatically when the parking assistant is activated.

Overview

Button in the vehicle



Parking assistant

تلفن شبانه روزی:

Ultrasound sensors



The ultrasound sensors for measuring parking spaces are located on the side of the vehicle.

To ensure full functionality:

- ▷ Keep the sensors clean and free of ice.
- ▷ When using high-pressure washers, do not spray the sensors for long periods and maintain a distance of at least 12 in/30 cm.
- ▷ Do not put stickers over sensors.

Requirements

For measuring parking spaces

- ▷ Maximum speed while driving forward approx. 22 mph/35 km/h.
- ▷ Maximum distance to row of parked vehicles: 5 ft/1.5 m.

Suitable parking space

- ▷ Gap between two objects with a minimum length of approx. 5 ft/1.5 m.
- ▷ Min. length of gap between two objects: your vehicle's length plus approx. 4 ft/1.2 m.
- ▷ Minimum depth: approx. 5 ft/1.5 m.

Regarding the parking procedure

- ▷ Doors and tailgate closed.
- ▷ Parking brake released.
- ▷ Driver's safety belt fastened.

Switching on/off

Switching on with the button

- ▷  Press button.
The LED lights up.

The current status of the parking space search is indicated on the Control Display.

- ▷  Parking assistant is activated automatically.

Switching on with the reverse gear

Shift into reverse.

The current status of the parking space search is indicated on the Control Display.

To activate:  "Parking Assistant"



Switch off

The system can be deactivated as follows:

- ▷  Press button.

Display on the Control Display

System activated/deactivated

Symbol	Meaning
	Gray: the system is not available. White: the system is available but not activated.
	The system is activated.

System status

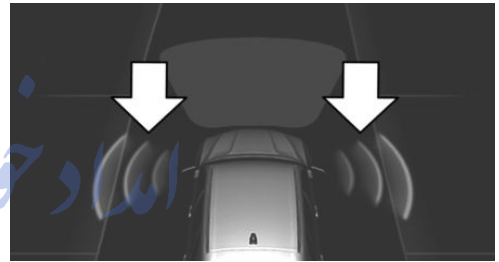

- ▷ Colored symbols, see arrows, on the side of the vehicle illustrated. Parking assistant is activated and search for parking space active.
- ▷ Control Display shows suitable parking spaces at the edge of the road next to the vehicle symbol. When the parking assistant is active, suitable parking spaces are high-lighted.
- ▷  The parking procedure is active. Steering control has been taken over by system.
- ▷ Parking space search is always active whenever the vehicle is moving forward slow and straight, even if the system is deactivated. When the system is deactivated, the displays on the Control Display are shown in gray.

Parking using the parking assistant

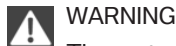



WARNING

The system does not relieve from the personal responsibility to correctly assess the traffic situation. There is risk of an accident. Adjust the driving style to the traffic conditions. Watch traffic and vehicle surroundings closely and actively interfere in the respective situations. ◀

1. Switch on the parking assistant and activate it if needed.
The status of the parking space search is indicated on the Control Display.
2. Follow the instructions on the Control Display.
The end of the parking procedure is indicated on the Control Display.
3. Adjust the parking position yourself if needed.

Interrupting manually

The parking assistant can be interrupted at any time:

- ▷  "Parking Assistant" Select the symbol on the Control Display.
- ▷  Press button.

Interrupting automatically

The system is interrupted automatically in the following situations:

- ▷ If the driver grasps the steering wheel or if he takes over steering.
- ▷ Possible on snow-covered or slippery road surfaces.
- ▷ When there are obstacles that are hard to overcome, such as curbs.
- ▷ When there are obstacles that suddenly arise.
- ▷ If the Park Distance Control PDC displays clearances that are too small.

- ▷ If a maximum number of parking attempts or the time taken for parking is exceeded.
 - ▷ When switching to another function on the Control Display.
 - ▷ When the button is released.
 - ▷ If the tailgate is open.
 - ▷ If doors are open.
 - ▷ When setting the parking brake.
 - ▷ During acceleration.
 - ▷ When braking.
 - ▷ When unfastening the driver's safety belt.
- A Check Control message is displayed.

Resume

An interrupted parking procedure can be continued if needed.

Follow the instructions on the Control Display to do this.

System limits

No parking assistance

The parking assistant does not offer assistance in the following situations:

- ▷ In tight curves.

Functional limitations

The system may not be fully functional in the following situations:

- ▷ On bumpy road surfaces such as gravel roads.
- ▷ On slippery ground.
- ▷ On steep uphill or downhill grades.
- ▷ With accumulations of leaves/snow in the parking space.

Limits of ultrasonic measurement

Ultrasonic measuring might not function under the following circumstances:

- ▷ For small children and animals.

- ▶ For persons with certain clothing, e.g. coats.
- ▶ With external interference of the ultrasound, e.g. from passing vehicles or loud machines.
- ▶ When sensors are dirty, iced over, damaged or out of position.
- ▶ Under certain weather conditions such as high relative humidity, rain, snowfall, extreme heat or strong wind.
- ▶ With tow bars and trailer couplings of other vehicles.
- ▶ With thin or wedge-shaped objects.
- ▶ With moving objects.
- ▶ With elevated, protruding objects such as ledges or cargo.
- ▶ With objects with corners and sharp edges.
- ▶ With objects with a fine surface structure such as fences.
- ▶ For objects with porous surfaces.

Low objects already displayed, e.g., curbs, can move into the blind area of the sensors before or after a continuous tone sounds.

It can happen that parking spaces are detected that are not suitable or suitable parking spaces are not detected.

Malfunction

A Check Control message is displayed.

The parking assistant failed. Have the system checked.

Climate control

Vehicle features and options

This chapter describes all standard, country-specific and optional features offered with the series. It also describes features that are not necessarily available in your car, e. g., due to

the selected options or country versions. This also applies to safety-related functions and systems. The respectively applicable country provisions must be observed when using the respective features and systems.

Automatic climate control

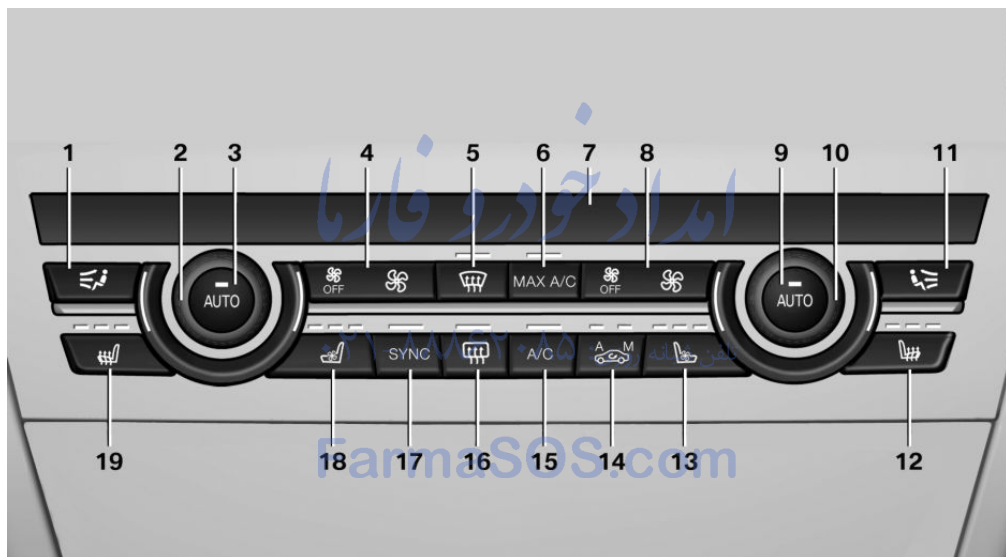

- | | |
|---|---|
| 1 Air distribution, left | 11 Air distribution, right |
| 2 Temperature, left | 12 Seat heating, right 54 |
| 3 AUTO program, left | 13 Active seat ventilation, right 54 |
| 4 Air flow, AUTO intensity, left, residual heat | 14 Automatic recirculated-air control/recirculated-air mode |
| 5 Remove ice and condensation | 15 Cooling function |
| 6 Maximum cooling | 16 Rear window defroster |
| 7 Display | 17 SYNC program |
| 8 Air flow, AUTO intensity, right | 18 Active seat ventilation, left 54 |
| 9 AUTO program, right | 19 Seat heating, left 54 |
| 10 Temperature, right | |

Climate control functions in detail

Switching the system on/off

Switching on

Press any button except:

- Rear window defroster.
- Left side of Air volume button.
- Seat heating.
- Seat ventilation.
- If necessary, SYNC program.

Switch off

- Complete system:



Press and hold the left button on the driver's side until the control clicks off.

- On the front passenger side:



Press and hold the left button on the front passenger side.

Temperature



Turn the ring to set the desired temperature.

The automatic climate control achieves this temperature as quickly as possible, if needed by using the maximum cooling or heating capacity, and then keeps it constant.

Do not rapidly switch between different temperature settings. Otherwise, the automatic climate control will not have sufficient time to adjust the set temperature.

Cooling function

The car's interior can only be cooled with the engine running.



Press button.

The air will be cooled and dehumidified and, depending on the temperature setting, warmed again.

Depending on the weather, the windshield and side windows may fog up briefly when the engine is started.

The cooling function is switched on automatically with the AUTO program.

When using the automatic climate control, condensation water, refer to page 190, develops that exits underneath the vehicle.

Maximum cooling



Press button.

The system is set to the lowest temperature, optimum air flow and air circulation mode.

Air flows out of the vents to the upper body region. The vents need to be open for this.

The function is available above an external temperature of approx. 32 °F/0 °C and with the engine running is indicated.

Adjust air flow with the program active.

AUTO program



Press button.

Air flow, air distribution and temperature are controlled automatically.

Depending on the selected temperature, AUTO intensity program and outside influences, the air is directed to the windshield, side windows, upper body, and into the footwell.

The cooling function, refer to page 165, is switched on automatically with the AUTO program.

At the same time, a condensation sensor controls the program so as to prevent window condensation as much as possible.

Intensity of the AUTO program

With the AUTO program activated, the automatic intensity control can be changed.



Press the left or right side of the button: decrease or increase the intensity.

The selected intensity is shown on the display of the automatic climate control.

Automatic recirculated-air control/ recirculated-air mode

You may respond to unpleasant odors or pollutants in the immediate environment by temporarily suspending the supply of outside air. The system then recirculates the air currently within the vehicle.



Press button repeatedly to select an operating mode:

- ▷ LEDs off: outside air flows in continuously.
- ▷ Left LED on, automatic recirculated-air control: a sensor detects pollutants in the outside air and shuts off automatically.
- ▷ Right LED on, recirculated-air mode: the supply of outside air into the vehicle is permanently blocked.

With constant recirculated-air mode, the air quality in the car's interior deteriorates and the fogging of the windows increases.

If the windows are fogged over, switch off the recirculated-air mode and press the AUTO button on the driver's side to utilize the condensation sensor. Make sure that air can flow to the windshield.

Air flow, manual

To manually adjust air flow turn off AUTO program first.



Press the left or right side of the button: decrease or increase air flow.

The selected air flow is shown on the display of the automatic climate control.

The air flow of the automatic climate control may be reduced automatically to save battery power.

Manual air distribution



Press button repeatedly to select a program:

- ▷ Upper body region.
- ▷ Upper body region and footwell.
- ▷ Footwell.
- ▷ Windows and footwell.
- ▷ Windows, upper body region, and footwell.
- ▷ Windows: driver's side only.
- ▷ Windows and upper body region.

If the windows are fogged over, press the AUTO button on the driver's side to utilize the condensation sensor.

SYNC program



The current settings on the driver's side for temperature, air flow, air distribution, and AUTO program are transferred to the front passenger side and to the left and right rear.

The program is switched off if the settings on the front passenger side or in the rear are changed.

Residual heat

The heat stored in the engine is used to heat the interior.

Functional requirement

- ▷ Up to 15 minutes after switching off the engine.
- ▷ Warm engine.
- ▷ The battery is sufficiently charged.
- ▷ External temperature below 77 °F/25 °C.

The availability of the function is shown on the display of the automatic climate control.

Switching on

1. Switch off the ignition.

2.  Press the right side of the button on the driver's side.

⏏ The symbol appears on the automatic climate Control Display.

The interior temperature, air volume and air distribution can be adjusted with the ignition switched on.

Switch off

At the lowest fan speed, press the left side of the button on the driver's side.

⏏ The symbol on the display of the automatic climate control flashes.

Defrosts windows and removes condensation



Press button.

Ice and condensation are quickly removed from the windshield and the front side windows.

For this purpose, point the side vents onto the side windows as needed.

Adjust air flow with the program active.

If the windows are fogged over, you can also switch on the cooling function or press the AUTO button to utilize the condensation sensor.

Rear window defroster



Press button.

The rear window defroster switches off automatically after a certain period of time.

Microfilter/activated-charcoal filter

The microfilter removes dust and pollen from the incoming air.

The activated-charcoal filter removes gaseous pollutants from the outside air that enters the vehicle.

This combined filter should be replaced during scheduled maintenance, refer to page 228, of your vehicle.

Ventilation

Front ventilation

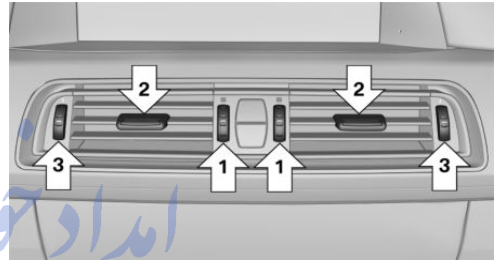

- ▶ Thumbwheels to vary the temperature in the upper body region, arrow 1.
 - Toward blue: colder.
 - Toward red: warmer.
- The set interior temperature for the driver and passenger are not changed.
- ▶ Lever for changing the air flow direction, arrow 2.
- ▶ Thumbwheels for opening and closing the vents continuously, arrows 3.

Adjusting the ventilation

- ▶ Ventilation for cooling:
 - Direct vent in your direction when vehicle's interior is too hot.
- ▶ Draft-free ventilation:
 - Adjust the vent to let the air flow past you.

Ventilation in rear, center

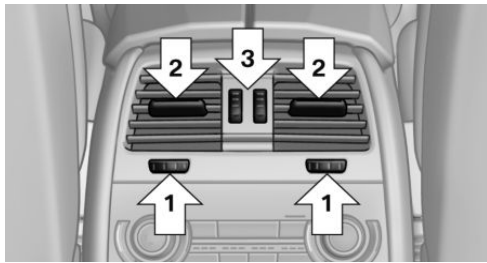

- ▷ Thumbwheels to vary the temperature, arrow 1.
Toward blue: colder.
Toward red: warmer.
- ▷ Lever for changing the air flow direction, arrow 2.
- ▷ Thumbwheels for continuous opening and closing of the vents, arrow 3.

Rear automatic climate control

Overview



- 1 Temperature
- 2 AUTO program
- 3 Vent settings
- 4 Air flow, AUTO intensity
- 5 Display
- 6 Maximum cooling
- 7 Seat heating 55

Switching the rear automatic climate control on/off

1. "Settings"
2. "Climate"
3. "Rear climate"

The rear automatic climate control is not operational if the automatic climate control is switched off or if the function for defrosting or defogging the windows is active.

Switching the system on/off

Switching on

Press any button except:

- ▷ Left side of Air volume button.
- ▷ Seat heating.

Switch off



Press and hold the left button.

Temperature



Turn the ring to set the desired temperature.

The automatic climate control achieves this temperature as quickly as possible, if needed by using the maximum cooling or heating capacity, and then keeps it constant.

Do not rapidly switch between different temperature settings. The automatic climate control will not have sufficient time to adjust the set temperature.

Maximum cooling



Press button.

The system is set to the lowest temperature, maximum air flow and air circulation mode.

Air flows out of the vents to the upper body region. The vents need to be open for this.

Air is cooled as quickly as possible:

- ▷ At an external temperature of approx. 32 °F/0 °C.
- ▷ When the engine is running.

AUTO program

 Press button. Air flow, air distribution, and temperature are controlled automatically:

Depending on the selected temperature, the AUTO intensity, and outside influences, the air is directed to the upper body and into the footwell.

The cooling function is switched on automatically with the AUTO program.

Intensity of the AUTO program

With the AUTO program activated, the automatic intensity control can be changed:

 Press the left or right side of the button: decrease or increase the intensity.

The selected intensity is shown on the display of the automatic climate control.

Air flow, manual

To manually adjust air flow turn off AUTO program first.

 Press the left or right side of the button: decrease or increase air flow.

The selected air flow is shown on the display of the automatic climate control.

Manual air distribution

The air distribution can be adjusted to individual needs.

 Press button repeatedly to select a program:

- ▷ Upper body region.
- ▷ Upper body region and footwell.
- ▷ Footwell.

Parked-car ventilation

The concept

The parked-car ventilation ventilates the vehicle interior and lowers its temperature, if needed.

The system can be switched on and off directly or by using two preset departure times.

The reel-on time is automatically determined based on the temperature. The system promptly switches on before the selected departure time.

Operation can be performed via iDrive.

Functional requirements

Parked-car ventilation

- ▷ When the departure time is preselected: depends on internal, external and set temperature.
- ▷ Direct operation: any external temperature. Open the vents to allow air to flow out.

Switching on/off directly

On the Control Display:

1. "Settings"
2. "Climate"
3. "Activate now"

 The symbol on the automatic climate control flashes if the system is switched on.

The system continues to run for some time after being switched off.

Setting departure time

On the Control Display:

1. "Settings"
2. "Climate"
3. Select the departure time.
Turn the controller until the desired departure time field has been selected and press Controller.
4. Set the time.
Turn the controller until the desired time is set and press the controller.

Activating the departure time

On the Control Display:

1. "Settings"
2. "Climate"
3. Activating the desired departure time:
"for departure at"

☞ The symbol on the automatic climate control lights up when the departure time is activated.

☞ The symbol on the automatic climate control flashes when the system has been switched on.

The system will only be switched on within the next 24 hours. After that, it needs to be reactivated.

امداد خودرو فارس

تلفن شبانه روزی: ۰۲۱-۸۸۶۲۰۸۵

FarmaSOS.com

Interior equipment

Vehicle features and options

This chapter describes all standard, country-specific and optional features offered with the series. It also describes features that are not necessarily available in your car, e. g., due to the selected options or country versions. This also applies to safety-related functions and systems. The respectively applicable country provisions must be observed when using the respective features and systems.

Universal Integrated Remote Control

The concept

The universal garage door opener can operate up to 3 functions of remote-controlled systems such as garage door drives or lighting systems. The universal garage door opener replaces up to 3 different hand-held transmitters. To operate the remote control, the buttons on the interior rearview mirror must be programmed with the desired functions. The hand-held transmitter for the particular system is required in order to program the remote control.

Before selling the vehicle, delete the stored functions for the sake of security.

Information



WARNING

Body parts can be jammed when operating remote-controlled systems, e.g. the garage door, using the universal garage door opener. There is risk of injuries or risk of property damage. Make sure that the area of movement of the respective system is clear during programming and operation. Also follow the safety instructions of the hand-held transmitter. ◀

Compatibility



If this symbol is printed on the packaging or in the instructions of the system to be controlled, the system is generally compatible with the universal garage door opener.

If you have any questions, please contact:

- ▷ A dealer's service center or another qualified service center or repair shop.
- ▷ www.homelink.com on the Internet.

HomeLink is a registered trademark of Gentex Corporation.

Controls on the interior rearview mirror

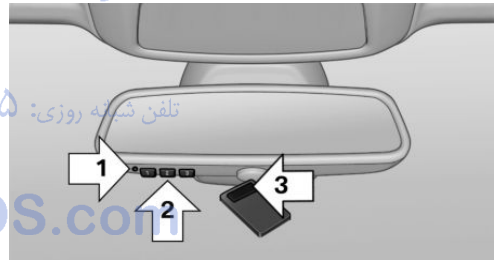

- ▷ LED, arrow 1.
- ▷ Buttons, arrow 2.
- ▷ The hand-held transmitter, arrow 3, is required for programming.

Programming

General information

1. Switch on the ignition.
2. Initial setup:

Press and hold the left and right button on the interior rearview mirror simultaneously for approximately 20 seconds until the LED on the interior rearview mirror flashes. This

erases all programming of the buttons on the interior rearview mirror.

3. Hold the hand-held transmitter for the system to be controlled approx. 1 to 3 in/2.5 to 8 cm away from the buttons of the interior rearview mirror. The required distance depends on the manual transmitter.
4. Simultaneously press and hold the button of the desired function on the hand-held transmitter and the button to be programmed on the interior rearview mirror. The LED on the interior rearview mirror will begin flashing slowly.
5. Release both buttons as soon as the LED flashes more rapidly. The LED flashing faster indicates that the button on the interior rearview mirror has been programmed. If the LED does not flash faster after at least 60 seconds, change the distance between the interior rearview mirror and the hand-held transmitter and repeat the step. Several more attempts at different distances may be necessary. Wait at least 15 seconds between attempts.

Canada: if programming with the hand-held transmitter was interrupted, hold down the interior rearview mirror button and repeatedly press and release the hand-held transmitter button for 2 seconds.

6. To program other functions on other buttons, repeat steps 3 to 5.

The systems can be controlled using the interior rearview mirror buttons.

Special feature of the alternating-code wireless system

If you are unable to operate the system after repeated programming, please check if the system to be controlled features an alternating-code system.

Read the system's operating manual, or press the programmed button on the interior rearview mirror longer. If the LED on the interior

rearview mirror starts flashing rapidly and then stays lit constantly for 2 seconds, the system features an alternating-code system. Flashing and continuous illumination of the LED will repeat for approximately 20 seconds.

For systems with an alternating-code system, the universal garage door opener and the system also have to be synchronized.

Please read the operating manual to find out how to synchronize the system.

Synchronizing is easier with the aid of a second person.

To synchronize:

1. Park the vehicle within range of the remote-controlled system.
2. Program the relevant button on the interior rearview mirror as described.
3. Locate and press the synchronizing button on the system being programmed. You have approx. 30 seconds for the next step.
4. Hold down the programmed button on the interior rearview mirror for approximately 3 seconds and then release it. If necessary, repeat this step up to three times in order to finish synchronization. Once synchronization is complete, the programmed function will be carried out.

Reprogramming individual buttons

1. Switch on the ignition.
2. Press and hold the interior rearview mirror button to be programmed.
3. As soon as the interior rearview mirror LED starts flashing slowly, hold the hand-held transmitter for the system to be controlled approx. 1 to 3 in/2.5 to 8 cm away from the buttons of the interior rearview mirror. The required distance depends on the manual transmitter.

4. Likewise, press and hold the button of the desired function on the hand-held transmitter.
5. Release both buttons as soon as the interior rearview mirror LED flashes more rapidly. The LED flashing faster indicates that the button on the interior rearview mirror has been programmed. The system can then be controlled by the button on the interior rearview mirror.

If the LED does not flash faster after at least 60 seconds, change the distance and repeat the step. Several more attempts at different distances may be necessary. Wait at least 15 seconds between attempts.

Canada: if programming with the hand-held transmitter was interrupted, hold down the interior rearview mirror button and repeatedly press and release the hand-held transmitter button for 2 seconds.

Controls



WARNING

Body parts can be jammed when operating remote-controlled systems, e.g. the garage door, using the universal garage door opener. There is risk of injuries or risk of property damage. Make sure that the area of movement of the respective system is clear during programming and operation. Also follow the safety instructions of the hand-held transmitter. ◀

The system, such as the garage door, can be operated using the button on the interior rearview mirror while the engine is running or when the ignition is started. To do this, hold down the button within receiving range of the system until the function is activated. The interior rearview mirror LED stays lit while the wireless signal is being transmitted.

Deleting stored functions

Press and hold the left and right button on the interior rearview mirror simultaneously for ap-

proximately 20 seconds until the LED flashes rapidly. All stored functions are deleted. The functions cannot be deleted individually.

Sun visor

Glare shield

Fold the sun visor down or up.

Glare shield from the side

Folding out

1. Fold the sun visor down.
2. Unhook it from the holder and swing it to the side.
3. Move it back to the desired position.

Folding up

Proceed in the reverse order to close the sun visor.

Vanity mirror

A vanity mirror is located in the sun visor behind a cover. When the cover is opened, the mirror lighting switches on.

Ashtray

Front

Opening



Slide the cover forward.

Emptying

Take out the insert.

Rear

Opening

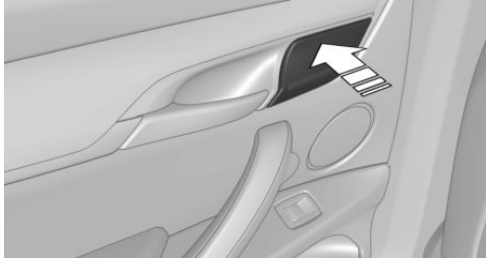

Press on the cover.

Emptying

Take out the insert.

Lighter

Information



WARNING

Contact with hot heating elements or the hot socket of the cigarette lighter can cause burns. Flammable materials can ignite if the cigarette lighter falls down or is held against the respective objects. There is risk of fire and injuries. Hold the cigarette lighter on its handle. Make sure that children do not use the cigarette lighter and do not burn themselves, e.g. by carrying the remote control along when exiting the vehicle. ◀



CAUTION

If metal objects fall into the socket, they can cause a short circuit. There is risk of property damage. Replace the cigarette lighter or socket cover again after using the socket. ◀

Front

Overview

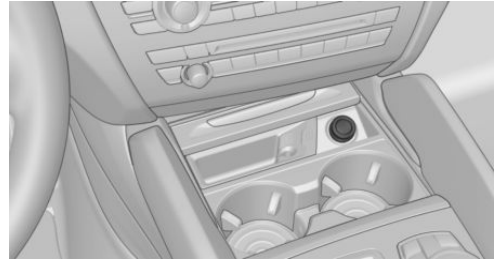

The lighter is located next to the ashtray.

Controls



Push in the lighter.

The lighter can be removed as soon as it pops back out.

Rear

Overview



The cigarette lighter is located in the rear center console.

Controls



Push in the lighter.

The lighter can be removed as soon as it pops back out.

Connecting electrical devices

Information

CAUTION

Battery chargers for the vehicle battery can work with high voltages and currents, which means that the 12V on-board network can be overloaded or damaged. There is risk of property damage. Only connect battery chargers for the vehicle battery to the starting aid terminals in the engine compartment. ◀

CAUTION

If metal objects fall into the socket, they can cause a short circuit. There is risk of property damage. Replace the cigarette lighter or socket cover again after using the socket. ◀

Sockets

General information

The lighter socket can be used as a socket for electrical equipment while the engine is running or when the ignition is switched on.

Information

The total load of all sockets must not exceed 140 watts at 12 volts.

Do not damage the socket by using non-compatible connectors.

Front center console



Slide the cover forward.

Remove the cover or cigarette lighter.

Center armrest



Remove the cover.

Rear center console



Remove the cover or cigarette lighter.

In the trunk



Fold open the cover.

USB interface for data transfer

The concept

Connection for importing and exporting data on USB devices, e.g.:

- ▷ Personal Profile settings, refer to page 35.
- ▷ Music collection, see user's manual for Navigation, Entertainment and Communication.

Information

Observe the following when connecting:

- ▷ Do not use force when plugging the connector into the USB interface.
- ▷ Do not connect devices such as fans or lights to the USB interface.
- ▷ Do not connect USB hard drives.
- ▷ Do not use the USB interface for recharging external devices.

With navigation system Professional or TV: at a glance

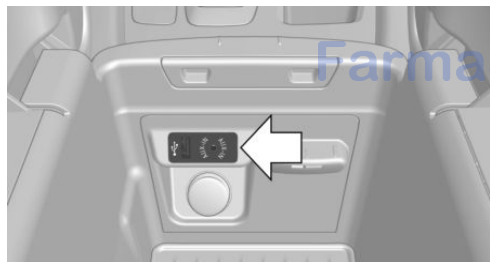

The USB interface is located in the center armrest.

Rear cooler

Information



WARNING

The cover of the opened cooler protrudes into the car's interior. Injuries can occur in the event of an accident, braking or evasive maneuver. The content of the cooler can be thrown into the car's interior and injure occupants. There is risk of injuries. Close the cooler after use when driving. ◀

Folding down the middle section



Reach into the recess and pull forward.

Opening



Pull on the opener and fold the cooler forward.

Switching on

The cooler can be operated at two levels.

1. Switch on the ignition.
2.  Press button once for each cooling level.

The highest cooling power is active when two LEDs are lit.

If the cooler was switched on the last time the ignition was switched on, it will likewise be switched on the next time the ignition is switched on.

Switch off

Press button repeatedly until the LEDs go out.

Removing

1. Pull handles on both sides, arrows.

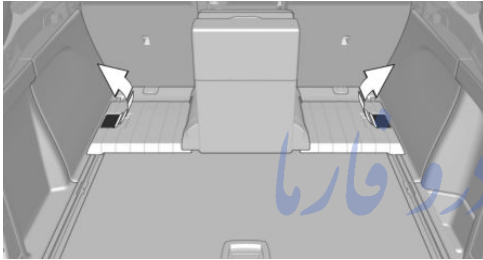

2. Fold both release levers up.

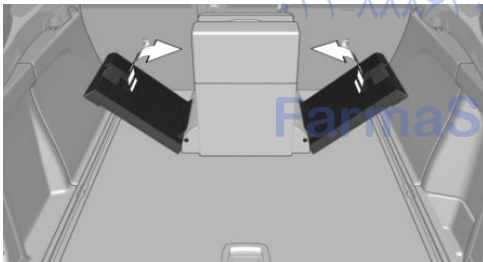

3. Pull cooler downward and remove it.

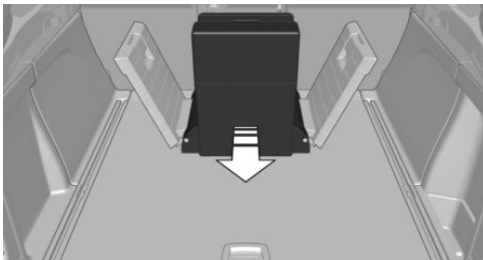

Installing

1. Fold the release levers with an angle of approx. 45° and push the cooler forward onto the contact up to the stop.

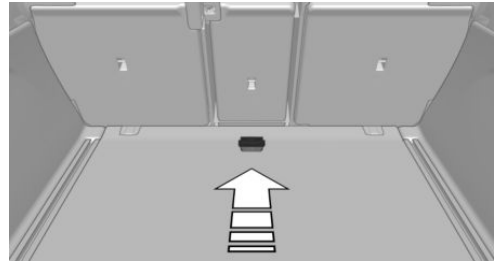

2. Fold both release levers down.
3. Pull handles, arrows 1, and press the release levers, arrows 2, into the rails, until they latch.

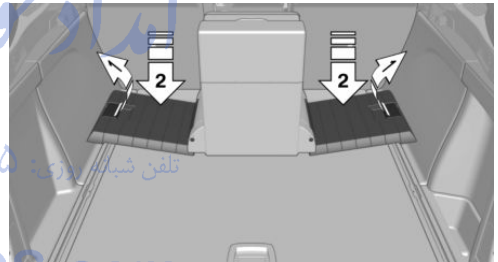

Malfunction

The cooler cannot be switched on or switches off, e.g., when the cooling system overheats or if the battery voltage is low. One of the LEDs flashes.

Remedy the problem

1. If necessary, allow the refrigerator cooling system to cool down.
2. Start the engine.
3. Switch on cooler.

If the LED flashes even after a short time, have the cooler checked by a dealer's service center or another qualified service center or repair shop.

Cargo area

Cargo cover

Information

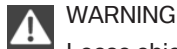

WARNING

Loose objects in the car's interior can be thrown into the car's interior while driving, e.g. in the event of an accident or during braking and evasive maneuvers. There is risk of injuries. Secure loose objects in the car's interior. ◀

General information

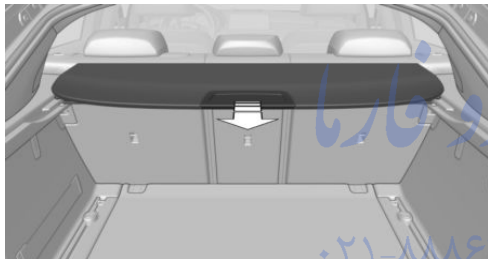

Unfold cargo cover out towards the rear.

Removing

The cover can be removed to load bulky luggage.

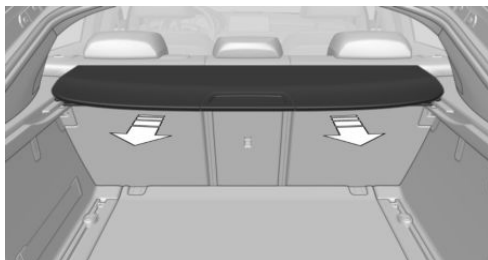

1. Grasp folded-up cargo cover under the top fold on both sides.
2. Pull the cover rearward out of the two side brackets.

Stowing

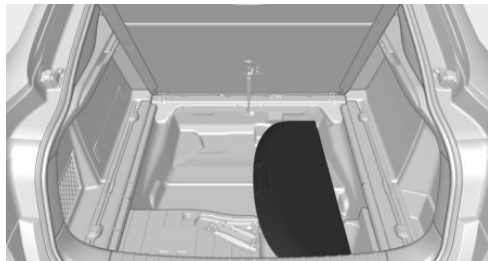

Depending on the equipment of your vehicle, you can stow the cover under the cargo floor panel.

Installing

When installing, follow the reverse procedure.

1. Put the cargo cover in place left and right.
2. Lift the cover slightly to the rear and push toward the front until it engages on both side brackets.

Enlarging the trunk

General information

The trunk can be enlarged by folding down the rear seat backrest.

The rear seat backrest is divided at a ratio of 40–20–40. The sides and the middle section can be folded down separately.

Information



WARNING

Danger of jamming with folding down the backrests. There is risk of injuries or risk of property damage. Make sure that the area of movement of the rear backrest is clear prior to folding down. ◀



WARNING

The stability of the child restraint system is limited or compromised with incorrect seat adjustment or improper installation of the child seat. There is risk of injuries or danger to life.

Make sure that the child restraint system fits securely against the backrest. If possible, adjust the backrest tilt for all affected backrests and correctly adjust the seats. Make sure that seats and backrests are securely engaged. If possible, adjust the height of the head restraints or remove them. ◀

WARNING

With an unlocked backrest, an unsecured load can be thrown into the car's interior, e.g. in case of an accident, braking or evasive maneuver. There is risk of injuries. Make sure that the backrest engages into the locking after folding it back. ◀

WARNING

With a rear backrest that is not locked, the protective function of the middle safety belt is not guaranteed. There is risk of injuries or danger to life. If you are using the middle safety belt, lock the wider rear backrest. ◀

Folding down the sides تلفن شبانه روزی: ۰۲۱-۸۸۸۶۲۰۸۵

CAUTION

Screens in the rear can be damaged when folding down the rear backrest. There is risk of property damage. Make sure that the area of movement is clear prior to folding down the rear backrest. ◀



Reach into the recess and pull forward.

Folding down the middle section

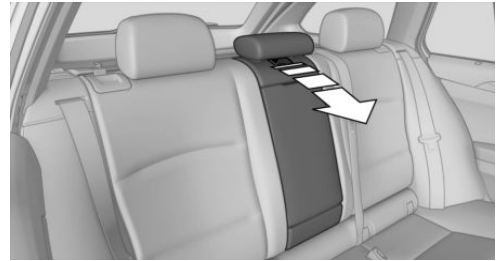

Reach into the recess and pull forward.

Ski and snowboard bag

General information

The ski and snowboard bag is contained in a protective jacket in the trunk.

Follow the installation and operation instructions included in the protective jacket.

Storage compartments

Vehicle features and options

This chapter describes all standard, country-specific and optional features offered with the series. It also describes features that are not necessarily available in your car, e. g., due to the selected options or country versions. This also applies to safety-related functions and systems. The respectively applicable country provisions must be observed when using the respective features and systems.

Information

WARNING

Loose objects in the car's interior can be thrown into the car's interior while driving, e.g. in the event of an accident or during braking and evasive maneuvers. There is risk of injuries. Secure loose objects in the car's interior. ◀

CAUTION

Anti-slip pads such as anti-slip mats can damage the dashboard. There is risk of property damage. Do not use anti-slip pads. ◀

Storage compartments

The following storage compartments are available in the vehicle interior:

- ▷ Glasses compartment, refer to page 182.
- ▷ Glove compartment on the front passenger side, refer to page 180.
- ▷ Glove compartment on the driver's side, refer to page 181.
- ▷ Compartments in the doors, refer to page 181.
- ▷ Storage compartment on the center console, refer to page 181.
- ▷ Center armrest, refer to page 181.

- ▷ Glasses compartment, refer to page 182.

Glove compartment

Front passenger side

Information

WARNING

Folded open, the glove compartment protrudes in the car's interior. Objects in the glove compartment can be thrown into the car's interior while driving, e.g. in the event of an accident or during braking and evasive maneuvers. There is risk of injuries. Always close the glove compartment immediately after using it. ◀

Opening

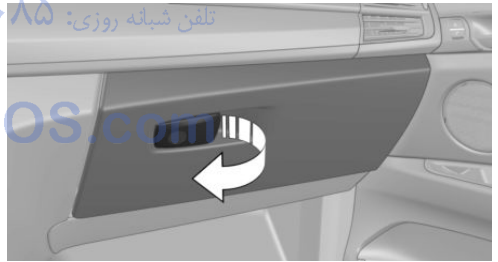

Pull the handle.

The light in the glove compartment switches on.

The retaining strap in the glove compartment is used to store small objects.

Closing

Fold cover closed.

Locking

The glove compartment can be locked with an integrated key. This prevents access to the glove compartment.

After the glove compartment is locked, the remote control can be handed over, such as at a hotel, without the integrated key.

Driver's side

Information

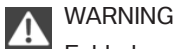

WARNING

Folded open, the glove compartment protrudes in the car's interior. Objects in the glove compartment can be thrown into the car's interior while driving, e.g. in the event of an accident or during braking and evasive maneuvers. There is risk of injuries. Always close the glove compartment immediately after using it. ◀

Opening



Pull the handle.

Closing

Fold cover closed.

Compartments in the doors

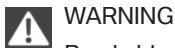

WARNING

Breakable object, e.g. glass bottle, can break in the event of an accident. Broken glass can be scattered in the car's interior. There is

risk of injuries. Do not stow any breakable objects in the car's interior. ◀

Storage compartment on the center console

Opening



Slide the cover forward.

Closing

Slide the cover rearward.

Small storage compartment

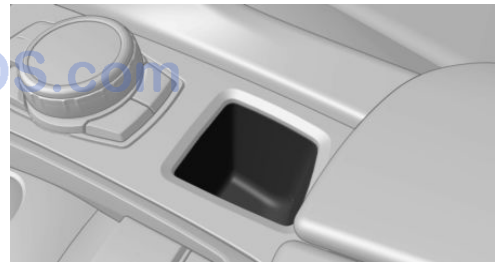

Storage possibility for small objects, e.g., coins.

Center armrest

Front

Overview

Located in the center armrest between the front seats is a storage compartment and de-

pending on how the vehicle is equipped also an elastic band on the left side and a cover for the snap-in adapter.

Opening

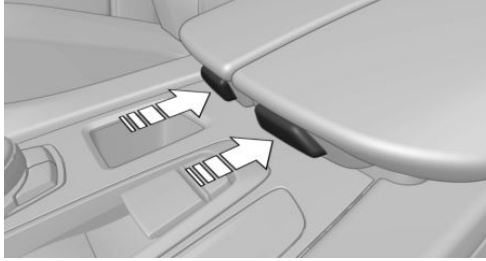

Push the cover down slightly and press the button, see arrow. The respective cover folds up.

Closing

Fold the respective cover down until it latches.

Connection for an external audio device



An external audio device, e.g., an MP3 player, can be connected via the AUX-IN port or the USB audio interface in the center armrest.

Rear

Overview

A storage compartment is located in the center armrest between the seats.

Opening

1. Pull the loop and fold down the center armrest.

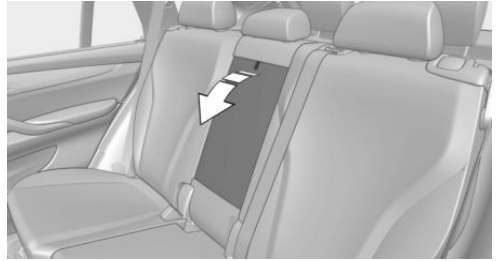

2. Pull the handle.

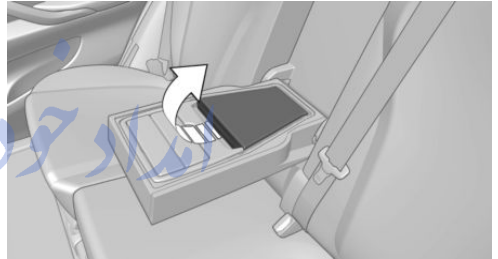

Closing

Press cover down until it latches.

Glasses compartment

Overview

The compartment for eye glasses is located between the interior mirror and interior lights.

Opening

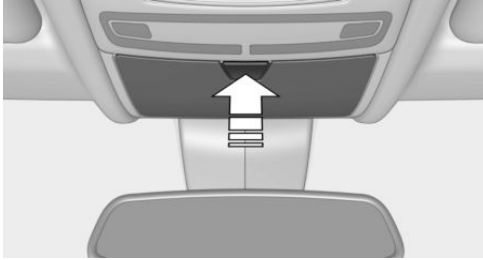

Press button.

Closing

Press the cover up until it latches.

Cupholders

Information



WARNING

Unsuitable containers in the cup holder and hot beverages can damage the cup holder and increase the risk of injuries in the event of an accident. There is risk of injuries or risk of property damage. Use light-weight, unbreakable, and sealable containers. Do not transport hot beverages. Do not force objects into the cup holder. ◀

Front

Overview

In the center console.

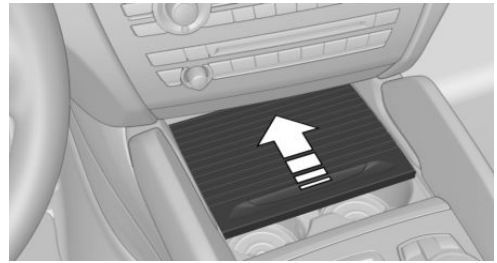

Slide the cover forward.

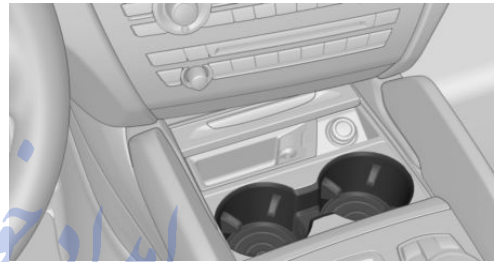

Two cupholders are located in the center console.

Rear تلفن شبانه ۰۸۵۰۰۸۵۰۰۸۵

Information



CAUTION

With an open cup holder, the center armrest cannot be folded back up. There is risk of property damage. Press back the covers before the center armrest is folded up. ◀

Overview

In the center armrest.

Opening

1. Pull the loop and fold down the center armrest.

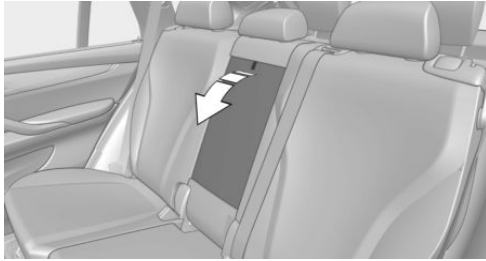

2. Press button.

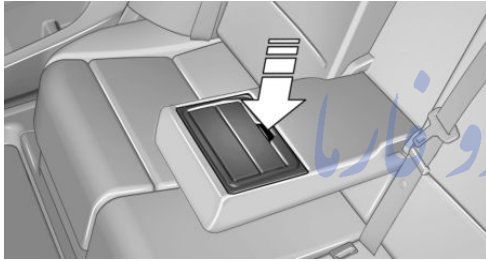

Closing

Press both covers inward back against each other.

Clothes hooks

WARNING

Clothing articles on the clothes hooks can obstruct the view while driving. There is risk of an accident. When suspending clothing articles from the hooks, ensure that they will not obstruct the driver's view. ◀

WARNING

Improper use of the clothes hooks can lead to a danger of objects flying about during braking and evasive maneuvers. There is risk of injuries and risk of property damage. Only hang lightweight objects, e.g. clothing articles, from the clothes hooks. ◀

Two folding clothes hooks are provided in the rear of the vehicle. Press sideways onto the edge to fold open.

Storage compartments in the trunk

Storage space under cargo floor panel

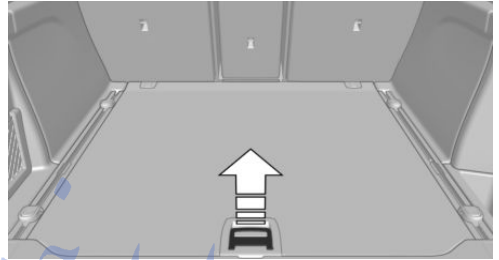

Fold up the cargo floor panel. The storage space under the cargo floor panel is subdivided.

Multi-function hook

WARNING

Improper use of the multifunction hooks can lead to a danger of objects flying about during braking and evasive maneuvers. There is risk of injuries and risk of property damage. Only hang lightweight objects, e.g. shopping bags, from the multifunction hooks. Only transport heavy luggage in the trunk if it has been appropriately secured. ◀

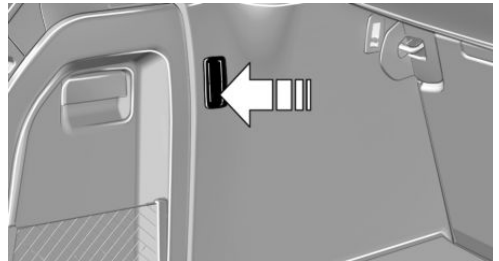

Depending on the installed equipment version, there are one or two multi-function hooks in the cargo area.

Retaining strap

A retaining strap is available on the left side trim for fastening small objects.

Net

Smaller objects can be stored in the net on the left side of the trunk.

Storage compartment on the right side

A waterproof storage compartment is available on the right side of the trunk.

Left side storage compartment

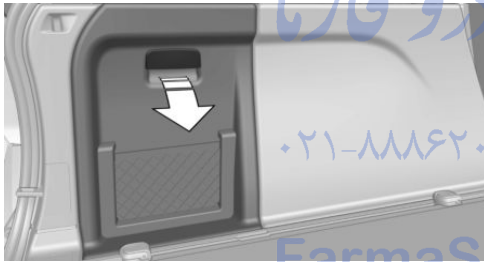

Pull the handle.

Lashing eyes in the trunk with rail

To secure the cargo, refer to page 193, there are lashing eyes in the cargo area.

Cargo net, FlexNet

To secure the cargo, refer to page 193, the flexible cargo net can also be used.



امداد خودرو فارما

تلفن شبانه روزی: ۰۲۱-۸۸۸۶۲۰۸۵

FarmaSOS.com

Driving tips

This chapter provides you with information useful in dealing with specific driving and operating modes.

امداد خودرو فارما

تلفن شبانه روزی: ۰۲۱-۸۸۸۶۲۰۸۵

FarmaSOS.com

Things to remember when driving

Vehicle features and options

This chapter describes all standard, country-specific and optional features offered with the series. It also describes features that are not necessarily available in your car, e. g., due to the selected options or country versions. This also applies to safety-related functions and systems. The respectively applicable country provisions must be observed when using the respective features and systems.

Breaking-in period

General information

Moving parts need time to adjust to one another (break-in time).

The following instructions will help accomplish a long vehicle life and good efficiency.

During break-in, do not use the Launch Control, refer to page 81.

Engine, transmission, and axle drive

Up to 1,200 miles/2,000 km

Do not exceed the maximum engine and road speed:

- ▷ For gasoline engine 4,500 rpm and 100 mph/160 km/h.

Avoid full load or kickdown under all circumstances.

From 1,200 miles/2,000 km

The engine and vehicle speed can gradually be increased.

Tires

Tire traction is not optimal due to manufacturing circumstances when tires are brand-new;

they achieve their full traction potential after a break-in time.

Drive conservatively for the first 200 miles/300 km.

Brake system

Brakes require an initial break-in period of approx. 300 miles/500 km to achieve optimal performance between brake discs and brake pads. Drive moderately during this break-in period.

Following part replacement

The same break-in procedures should be observed if any of the components above-mentioned have to be renewed in the course of the vehicle's operating life.

General driving notes

Closing the tailgate



WARNING

An open tailgate protrudes from the vehicle and can endanger occupants and other traffic participants or damage the vehicle in the event of an accident, braking or evasive maneuvers. In addition, exhaust fumes may enter the vehicle interior. There is risk of injuries or risk of property damage. Do not drive with the tailgate open. ◀

If driving with the tailgate open cannot be avoided:

- ▷ Close all windows and the glass sunroof.
- ▷ Greatly increase the air flow from the vents.
- ▷ Drive moderately.

Hot exhaust system



WARNING

During driving operation, high temperatures can occur underneath the body, e.g. caused by the exhaust gas system. If combustible materials, such as leaves or grass, come in contact with hot parts of the exhaust gas system, these materials can ignite. There is risk of injuries or risk of property damage.

Do not remove the heat shields installed and never apply undercoating to them. Make sure that no combustible materials can come in contact with hot vehicle parts in driving operation, idle or during parking. Do not touch the hot exhaust system. ◀

Climate control windshield

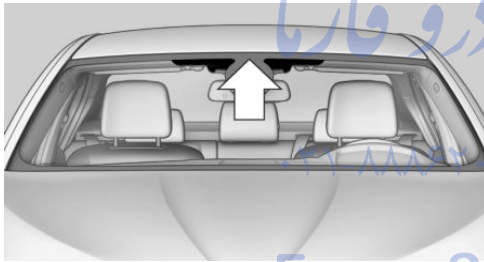

The marked area is not covered with heat reflective coating.

Use this area for garage door openers, devices for electronic toll collection, etc.

Mobile communication devices in the vehicle



WARNING

Vehicle electronics and mobile phones can influence one another. There is radiation due to the send operations of mobile phones. There is risk of injuries or risk of property damage. If possible, in the car's interior use only mobile phones with direct connections to an exterior antenna in order to exclude mutual disturbance and deflect the radiation from the car's interior. ◀

Hydroplaning

On wet or slushy roads, a wedge of water can form between the tires and road surface.

This phenomenon is referred to as hydroplaning. It is characterized by a partial or complete loss of contact between the tires and the road surface, ultimately undermining your ability to steer and brake the vehicle.

Driving through water



CAUTION

When driving too quickly through too deep water, water can enter into the engine compartment, the electrical system or the transmission. There is risk of property damage. When driving through water, do not exceed the maximum indicated water level and the maximum speed for driving through water. ◀

Drive through calm water only and only if it is not deeper than 17.6 inches/45 cm and at this height, no faster than walking speed, up to 3 mph/5 km/h.

Braking safely

Your vehicle is equipped with ABS as a standard feature.

Applying the brakes fully is the most effective way of braking in situations needed.

Steering is still responsive. You can still avoid any obstacles with a minimum of steering effort.

Pulsation of the brake pedal and sounds from the hydraulic circuits indicate that ABS is in its active mode.

In certain braking situations, the perforated brake discs can cause functional problems. However, this has no effect on the performance and operational reliability of the brake.

Objects in the movement area around pedals and floor area

WARNING

Objects in the driver's floor area can limit the pedal distance or block a depressed pedal. There is risk of an accident. Stow objects in the vehicle such that they are secured and cannot enter into the driver's floor area. Use floor mats that are suitable for the vehicle and can be safely attached to the floor. Do not use loose floor mats and do not layer several floor mats. Make sure that there is sufficient clearance for the pedals. Ensure that the floor mats are securely fastened again after they were removed, e.g. for cleaning. ◀

Driving in wet conditions

When roads are wet, salted, or in heavy rain, press brake pedal ever so gently every few miles.

Ensure that this action does not endanger other traffic.

The heat generated in this process helps dry the brake discs and pads.

In this way braking efficiency will be available when you need it.

Hills

WARNING

Light but consistent brake pressure can lead to high temperatures, brakes wearing out and possibly even brake failure. There is risk of an accident. Avoid placing excessive stress on the brake system. ◀

WARNING

In idle or with the engine switched off, safety-relevant functions are restricted or not available anymore, e.g. braking effect of the engine or braking force and steering support. There is risk of an accident. Do not drive in idle or with the engine switched off. ◀

Drive long or steep downhill gradients in the gear that requires least braking efforts. Otherwise the brakes may overheat and reduce brake efficiency.

You can increase the engine's braking effect by shifting down, going all the way to first gear, if needed.

Brake disc corrosion

Corrosion on the brake discs and contamination on the brake pads are furthered by the following circumstances:

- ▷ Low mileage.
- ▷ Extended periods when the vehicle is not used at all.
- ▷ Infrequent use of the brakes.

Corrosion will built up when the maximum pressure applied to the brake pads during braking is not reached - thus discs don't get cleaned.

Corrosion buildup on the brake discs will cause a pulsating effect on the brakes in their response - generally that cannot be corrected.

Condensation under the parked vehicle

When using the automatic climate control, condensation water develops collecting underneath the vehicle.

These traces of water under the vehicle are normal.

Driving on poor roads

The vehicle combines all-wheel drive with the advantages of a normal automobile.

CAUTION

Objects in unpaved areas, e.g. stones or branches, can damage the vehicle. There is risk of property damage. Do not drive on unpaved terrain. ◀

For your own safety, for the safety of passengers and of the vehicle, heed the following points:

- ▶ Become familiar with the vehicle before starting a trip; do not take risks in driving.
- ▶ Adjust the speed to the road surface conditions. The steeper and more uneven the road surface, the slower the speed should be.
- ▶ When driving on steep uphill or downhill grades: add engine oil and coolant up to near the MAX mark. Uphill and downhill grades can be traveled up to no more than 50 %.
- ▶ On steep downhill grades, use Hill Descent Control HDC, refer to page 137.
Starting out is possible on uphill grades up to 32 %. The permissible side tilt is 50 %.
- ▶ Avoid that the chassis bottom coming in contact with the ground.
The ground clearance is no more than 7.8 inches/20 cm and can vary according to the vehicle's load.
- ▶ When wheels continue to spin, depress the accelerator so that driving stability control systems can distribute the driving force to the wheels. Activate DTC Dynamic Traction Control if available.

After a trip on poor roads

After a trip on poor roads, check wheels and tires for damage to maintain driving safety. Clear heavy soiling from the body.

Loading

Vehicle features and options

This chapter describes all standard, country-specific and optional features offered with the series. It also describes features that are not necessarily available in your car, e. g., due to the selected options or country versions. This also applies to safety-related functions and systems. The respectively applicable country provisions must be observed when using the respective features and systems.

Information



WARNING

High gross weight can overheat the tires, damage them internally, and cause a sudden drop in tire inflation pressure. There is risk of an accident. Pay attention to the permitted load capacity of the tires and never exceed the permitted gross weight. ◀



CAUTION

Fluids in the cargo area can cause damage. There is risk of property damage. Make sure that no fluids leak in the cargo area. ◀



WARNING

Loose objects in the car's interior can be thrown into the car's interior while driving, e.g. in the event of an accident or during braking and evasive maneuvers. There is risk of injuries. Secure loose objects in the car's interior. ◀

or YYY lbs. Otherwise, damage to the vehicle and unstable driving situations may result.



2. Determine the combined weight of the driver and passengers that will be riding in your vehicle.
3. Subtract the combined weight of the driver and passengers from XXX kilograms or YYY pounds.
4. The resulting figure equals the available amount of cargo and luggage load capacity.

For example, if the YYY amount equals 1,000 lbs and there will be four 150 lbs passengers in your vehicle, the amount of available cargo and luggage load capacity is 400 lbs: 1,000 lbs minus 600 lbs = 400 lbs.

5. Determine the combined weight of luggage and cargo being loaded on the vehicle. That weight may not safely exceed the available cargo and luggage load capacity calculated in Step 4.

Determining the load limit

1. Locate the following statement on your vehicle's placard:
 - ▷ The combined weight of occupants and cargo should never exceed XXX kg

Load

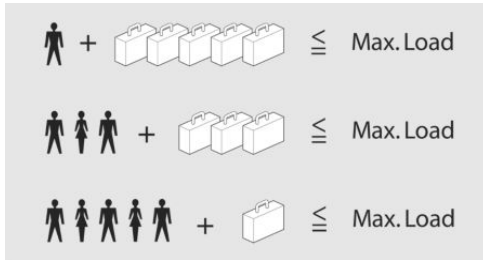

The maximum load is the sum of the weight of the occupants and the cargo.

The greater the weight of the occupants, the less cargo that can be transported.

Stowing cargo

- ▶ Cover sharp edges and corners on the cargo.
- ▶ Heavy cargo: stow as far forward as possible, directly behind and at the bottom of the rear passenger seat backrests.
- ▶ Very heavy cargo: when the rear seat is not occupied, secure each of the outer safety belts in the opposite buckle.
- ▶ If necessary, fold down the rear backrests to stow cargo.
- ▶ Do not stack cargo above the top edge of the backrests.

Securing cargo

Lashing eyes in the trunk with rails

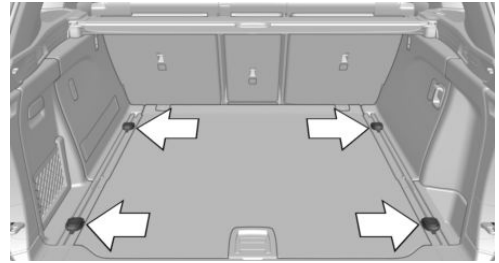

To secure the cargo there are four movable lashing eyes in the cargo area.

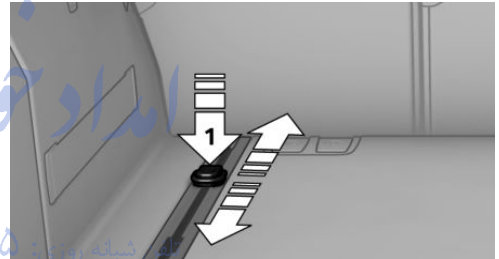

To slide the lashing eyes, press the button, arrow 1. Make sure that the lashing eyes latch at the new position.

The lashing eyes at the openings in the rails can be removed.

Cargo net, FlexNet

The flexible cargo net is hooked into eyes and offers a stowage option in the cargo area. The storage net can be attached to the following eyes:

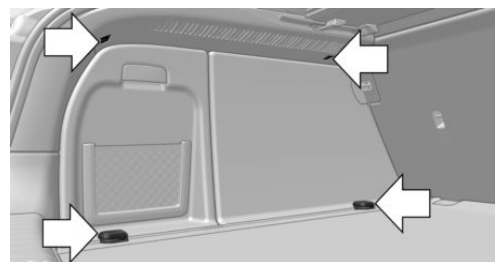

- ▷ Lashing eyes in the rails.
- ▷ Eyes on the trunk wall.

The eyes are located on both sides of the trunk.

Securing cargo



WARNING

Improperly stowed objects can shift and be thrown into the car's interior, e.g. in the event of an accident or during braking and evasive maneuvers. Vehicle occupants can be hit and injured. There is risk of injuries. Stow and secure objects and cargo properly. ◀

- ▷ Smaller and lighter items: secure with retaining straps or with a cargo net or draw straps.
- ▷ Larger and heavy objects: secure with cargo straps.

Cargo straps, cargo netting, retaining straps or draw straps on the lashing eyes in the trunk.

- ▷ Do not exceed the approved roof/axle loads and the approved gross vehicle weight.
- ▷ Be sure that adequate clearance is maintained for tilting and opening the glass sunroof.
- ▷ Distribute the roof load uniformly.
- ▷ The roof load should not extend past the loading area.
- ▷ Always place the heaviest pieces on the bottom.
- ▷ Secure the roof luggage firmly, e.g., tie with ratchet straps.
- ▷ Do not let objects project into the opening path of the tailgate.
- ▷ Drive cautiously and avoid sudden acceleration and braking maneuvers. Take corners gently.

تلفن شبانه روزی: ۰۲۱-۸۸۸۶۲۰۸۵

Roof-mounted luggage rack

Information

Installation only possible with roof rack.

Roof racks are available as special accessories.

Securing

Follow the installation instructions of the roof rack.

Loading

Because roof racks raise the vehicle's center of gravity when loaded, they have a major effect on vehicle handling and steering response.

Therefore, note the following when loading and driving:

FarmaSOS.com

Saving fuel

Vehicle features and options

This chapter describes all standard, country-specific and optional features offered with the series. It also describes features that are not necessarily available in your car, e. g., due to the selected options or country versions. This also applies to safety-related functions and systems. The respectively applicable country provisions must be observed when using the respective features and systems.

General information

Your vehicle contains advanced technology for the reduction of fuel consumption and emissions.

Fuel consumption depends on a number of different factors.

Carrying out certain measures, such as a moderate driving style and regular maintenance, can influence fuel consumption and the environmental impact.

Remove unnecessary cargo

Additional weight increases fuel consumption.

Remove attached parts following use

Remove auxiliary mirrors, roof or rear luggage racks which are no longer required following use.

Attached parts on the vehicle impair the aerodynamics and increase the fuel consumption.

Close the windows and glass sunroof

Driving with the glass sunroof and windows open results in increased air resistance and thereby reduces the range.

Tires

General information

Tires can affect fuel consumption in various ways, e.g., tire size may influence fuel consumption.

Check the tire inflation pressure regularly

Check and, if needed, correct the tire inflation pressure at least twice a month and before starting on a long trip.

Low tire inflation pressure increases rolling resistance and thus raises fuel consumption and tire wear.

Drive away immediately

Do not wait for the engine to warm-up while the vehicle remains stationary. Start driving right away, but at moderate engine speeds.

This is the quickest way of warming the cold engine up to operating temperature.

Look well ahead when driving

Avoid unnecessary acceleration and braking. By maintaining a suitable distance to the vehicle driving ahead of you.

Driving smoothly and proactively reduces fuel consumption.

Avoid high engine speeds

As a rule: driving at low engine speeds lowers fuel consumption and reduces wear.

Use 1st gear to get the vehicle moving. Starting with the 2nd gear, accelerate rapidly. When accelerating, shift up before reaching high engine speeds.

When you reach the desired speed, shift into the highest applicable gear and drive with the engine speed as low as possible and at a constant speed.

If necessary, observe the gear shift indicator of the vehicle, refer to page 93.

Use coasting

When approaching a red light, take your foot off the accelerator and let the vehicle coast to a halt.

For going downhill take your foot off the accelerator and let the vehicle roll.

The flow of fuel is interrupted while coasting.

Switch off the engine during longer stops

Switch off the engine during longer stops, e.g., at traffic lights, railroad crossings or in traffic congestion.

Auto Start/Stop function

The Auto Start/Stop function of your vehicle automatically switches off the engine during a stop.

If the engine is switched off and then restarted rather than leaving the engine running constantly, fuel consumption and emissions are reduced. Savings can begin within a few seconds of switching off the engine.

In addition, fuel consumption is also determined by other factors, such as driving style,

road conditions, maintenance or environmental factors.

Switch off any functions that are not currently needed

Functions such as seat heating and the rear window defroster require a lot of energy and reduce the range, especially in city and stop-and-go traffic.

Switch off these functions if they are not needed.

The ECO PRO driving program supports the energy conserving use of comfort features. These functions are automatically deactivated partially or completely.

Have maintenance carried out

Have vehicles maintained regularly to achieve optimal vehicle efficiency and service life. BMW recommends that maintenance work be performed by a BMW dealer's service center.

For information on the BMW Maintenance System, refer to page 228.

ECO PRO

The concept

ECO PRO supports a driving style that saves on fuel consumption. For this purpose, the engine control and comfort features, e. g. the climate control output, are adjusted.

In addition, context-sensitive instructions are displayed to assist with an optimized fuel consumption driving style.

The achieved extended range is displayed in the instrument cluster as bonus range.

Overview

The system includes the following EfficientDynamics functions and displays:

- ▶ ECO PRO bonus range, refer to page 197.
- ▶ ECO PRO tips driving instruction, refer to page 198
- ▶ ECO PRO climate control, refer to page 197.
- ▶ ECO PRO coasting driving status, refer to page 199.

Activate ECO PRO



Press button repeatedly until ECO PRO is displayed in the instrument cluster.

Configuring ECO PRO

Via the Driving Dynamics Control

1. Activate ECO PRO.
2. "Configure ECO PRO"
3. Configure the program.

Via the iDrive

1. "Settings"
2. "Driving mode"
3. "Configure ECO PRO"

Configure the program.

ECO PRO Tip

- ▶ "Tip at:":
Adjust the ECO PRO speed.
- ▶ "ECO PRO speed warning":
The output is reduced once the set ECO PRO speed is reached.

ECO PRO climate control

"ECO PRO climate control"

Climate control is set to be fuel-efficient.

By making a slight change to the set temperature, or slowly adjusting the rate of heating or cooling of the car's interior, fuel consumption can be economized.

The mirror heating is made available when outside temperatures are very cold.

ECO PRO potential

Shows potential savings with the current settings in percentages.

Display in the instrument cluster

Display in the instrument display

When ECO PRO mode is activated, the display switches to a special configuration.

Some of the displays may differ from the display in the instrument cluster.

Blue bar segments symbolize the gained bonus range in stages.

In addition, the bonus range is highlighted in blue in the total range display.

ECO PRO bonus range

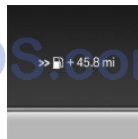

An adjusted driving style helps you extend your driving range.

This may be displayed as the bonus range in the instrument cluster.

The bonus range is shown in the range display.

The bonus range is automatically reset every time the vehicle is refueled.

Efficiency display

Display in the instrument cluster

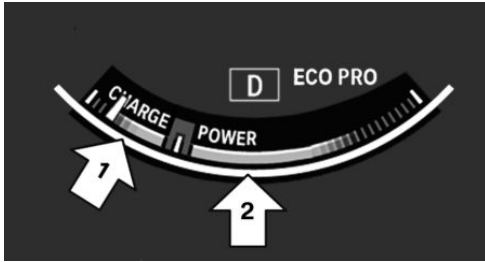

Display in the instrument display

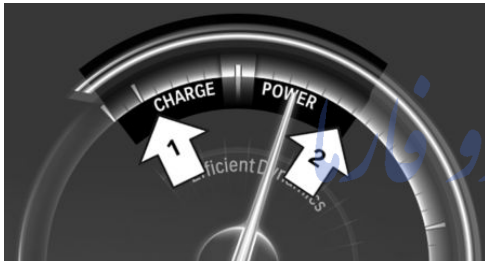

A mark in the efficiency display informs about the current driving style.

Mark in the area of arrow 1: the energy recovered by coasting or when braking.

Mark in the area of arrow 2: display when accelerating.

Your driving style's efficiency is shown by the bar's color:

- ▶ Blue display: efficient driving style as long as the mark moves within the blue range.
- ▶ Gray display: adjust driving style, e. g. by backing off the accelerator pedal.

The display switches to blue as soon as all conditions for fuel-efficiency-optimized driving are met.

ECO PRO tip, driving tip



The arrow indicates that the driving style can be adjusted to be more fuel

efficient by backing off the accelerator for instance.

Information

The efficiency display and ECO PRO tips in the instrument cluster appear when the ECO PRO display is activated.

Activating driving style and ECO PRO tips:



1. "Settings"
2. "Instrument cluster"
3. "ECO PRO Info"

In the instrument display:

1. "Settings"
2. "Instrument cluster"
3. "Driving mode view"

ECO PRO tip, symbols

An additional symbol and text instructions are displayed.

Symbol	Measure
	For efficient driving back off the accelerator or delay accelerating to allow time to assess road conditions.
	Reduce speed to the selected ECO PRO speed.
	Steptronic transmission: shift from M/S to D.

Indications on the Control Display

EfficientDynamics

Information on fuel consumption and technology can be displayed while driving.

1. "Vehicle info"
2. "EfficientDynamics"

Displaying EfficientDynamics info

The current efficiency can be displayed.

EfficientDynamics info

The following systems are displayed:

- ▶ Auto Start/Stop function.
- ▶ Energy recovery.
- ▶ Climate control output.

Display ECO PRO tips

Info "ECO PRO tips"

Settings are stored for the profile currently used.

Coasting

The concept

The system helps to conserve fuel.

To do this, under certain conditions the engine is automatically decoupled from the transmission when selector lever position D is set. The vehicle continues traveling with the engine idling to reduce fuel consumption. Selector lever position D remains engaged.

This driving condition is referred to as coasting.

As soon as you step on the brake or accelerator pedal, the engine is automatically coupled again.

Information

Coasting is a component of the ECO PRO, refer to page 196, driving mode.

Coasting is automatically activated when ECO PRO mode is called via the Driving Dynamics Control.

The function is available in a certain speed range.

A proactively driving style helps the driver to use the function as often as possible and supports the fuel-conserving effect of coasting.

Safety mode

The function is not available under one of the following conditions.

- ▶ DSC OFF or TRACTION activated.
- ▶ Driving in the dynamic limit range and on steep uphill or downhill grades.
- ▶ Battery charge status temporarily too low or vehicle electrical system drawing excessive current.
- ▶ Cruise control activated.

Functional requirements

In ECO PRO mode, this function is available in a speed range from approximately 30 mph, approx. 50 km/h to 100 mph, approx. 160 km/h, if the following conditions are met:

- ▶ Accelerator pedal and brake pedal are not operated.
- ▶ The selector lever is in selector lever position D.
- ▶ Engine and transmission are at operating temperature.

The driving status Coast can be influenced with the shift paddles.

Display

Display in the instrument cluster



The mark in the efficiency display below the tachometer is backlit in blue and is located at the zero point. The tachometer approximately indicates idle

speed.

The coasting point indicator is illuminated at the zero point during coasting.

Display in the instrument display

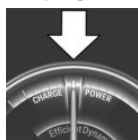

The mark in the efficiency display is backlit in blue and is located at the zero point.

The coasting point indicator is illuminated at the zero point during

coasting.

Indications on the Control Display

The Coasting driving condition is displayed in EfficientDynamics Info while this driving mode is active.

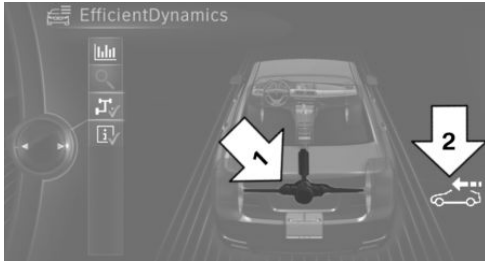

Color code blue, arrow 1, and symbol, arrow 2: driving condition Coasting.

Displaying EfficientDynamics info

1. "Vehicle info"
2. "EfficientDynamics"
3.  "EfficientDynamics info"

Deactivating the system manually

The function can be deactivated in the Configuration ECO PRO, refer to page 197, menu, e.g., to use the braking effect of the engine when traveling downhill.

Settings are stored for the profile currently used.

امداد خودرو فارما

تلفن شبانه روزی: ۰۲۱-۸۸۶۲۰۸۵

FarmaSOS.com

امداد خودرو فارما

تلفن شبانه روزی: ۰۲۱-۸۸۸۶۲۰۸۵

FarmaSOS.com



امداد خودرو فارما

تلفن شبانه روزی: ۰۲۱-۸۸۸۶۲۰۸۵

FarmaSOS.com

Mobility

In order to always ensure your mobility, you will find important information on operating fluids, wheels and tires, maintenance and Roadside Assistance in the following.

امداد خودرو فارما

تلفن شماره روزی: ۰۲۱-۸۸۸۶۲۰۸۵

FarmaSOS.com

Refueling

Vehicle features and options

This chapter describes all standard, country-specific and optional features offered with the series. It also describes features that are not necessarily available in your car, e. g., due to the selected options or country versions. This also applies to safety-related functions and systems. The respectively applicable country provisions must be observed when using the respective features and systems.

Information

Observe the fuel recommendation, refer to page 206, prior to refueling.

CAUTION

With a range of less than 30 miles/50 km it is possible that the engine will no longer have sufficient fuel. Engine functions are no longer ensured. There is risk of property damage. Refuel promptly. ◀

Fuel lid

Opening

1. Briefly press the rear edge of the fuel filler flap.



2. Turn the tank lid counterclockwise.

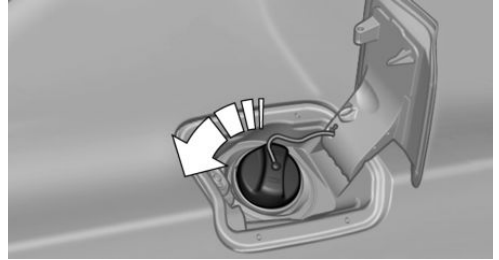

3. Place the tank lid in the bracket attached to the fuel filler flap.



Closing

1. Fit the lid and turn it clockwise until you clearly hear a click.
2. Close the fuel filler flap.

WARNING

The retaining strap of the fuel cap be jammed and crushed during closing. In this case, the lid cannot be correctly closed and fuel vapors or fuel can escape. There is risk of injuries or risk of property damage. Pay attention that the retaining strap is not jammed or crushed when closing the lid. ◀

Manually unlocking fuel filler flap

E. g. in the event of an electrical malfunction. The release is located in the trunk.

1. Open the cover on the right side trim.

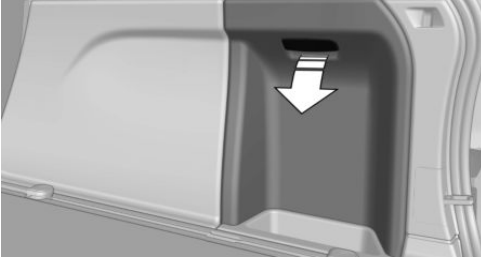

2. Pull the green knob with the fuel pump symbol. This releases the fuel filler flap.

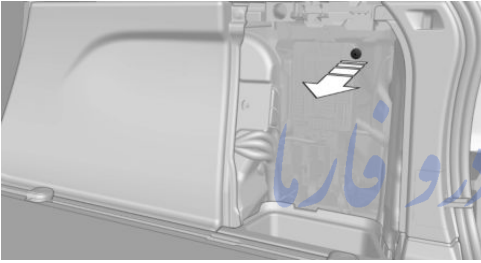

Observe the following when refueling

تلفن شبانه روزی: ۰۲۱-۸۸۸۶۲۰۸۵



CAUTION

Fuels are toxic and aggressive. Overfilling of the fuel tank can damage the fuel system. On contact with painted surfaces, damage may occur to these surfaces. The environment is polluted. There is risk of property damage. Avoid overfilling. ◀

The fuel tank is full when the filler nozzle clicks off the first time.

Observe safety regulations posted at the gas station.

FarmaSOS.com

Fuel

Vehicle features and options

This chapter describes all standard, country-specific and optional features offered with the series. It also describes features that are not necessarily available in your car, e. g., due to the selected options or country versions. This also applies to safety-related functions and systems. The respectively applicable country provisions must be observed when using the respective features and systems.

Fuel recommendation

General information

Depending on the region, many gas stations sell fuel that has been customized to winter or summer conditions. Fuel that is available in winter helps make a cold start easier, e.g.

Information

CAUTION

Even fuels that conform to the specifications can be of low quality. This may cause engine problems, for instance poor engine start-up behavior, poor handling and/or poor performance. There is risk of property damage. In case of engine problems, switch gas stations or use a brand name fuel with a higher octane rating. ◀

Gasoline

For the best fuel efficiency, the gasoline should be sulfur-free or very low in sulfur content.

Fuels that are marked on the gas pump as containing metal must not be used.

CAUTION

Even small amounts of wrong fuel or wrong fuel additives can damage the fuel system and the engine. Furthermore, the catalytic converter is permanently damaged. There is risk of property damage. Do not refuel or add the following in the case of gasoline engines:

- ▶ Leaded gasoline.
- ▶ Metallic additives, e.g. manganese or iron.

Do not press the Start/Stop button after refueling the wrong fuel. Contact a dealer's service center or another qualified service center or repair shop. ◀

Fuels with a maximum ethanol content of 10 %, i. e., E10, may be used for refueling. Ethanol should satisfy the following quality standards:

US: ASTM 4806-xx

CAN: CGSB-3.511-xx

xx: comply with the current standard in each case.

CAUTION

Wrong fuels can damage the fuel system and the engine. There is risk of property damage. Do not use a fuel with a higher ethanol percentage than recommended or one with other types of alcohol, e.g. M5 to M100. ◀

Recommended fuel grade

BMW recommends AKI 91.

Minimum fuel grade

BMW recommends AKI 89.

CAUTION

Fuel that does not comply with the minimum quality can compromise engine function or cause engine damage. There is risk of prop-

erty damage. Do not fill with fuel that does not comply with the minimum quality. ◀

If you use gasoline with this minimum AKI Rating, the engine may produce knocking sounds when starting at high outside temperatures. This has no effect on the engine life.



CAUTION

The use of poor-quality fuels may result in harmful engine deposits or damage. Additionally, problems relating to drivability, starting and stalling, especially under certain environmental conditions such as high ambient temperature and high altitude, may occur.

If drivability problems are encountered, we recommend switching to a high quality gasoline brand and a higher octane grade — AKI number — for a few tank fills. To avoid harmful engine deposits, it is highly recommended to purchase gasoline from Top Tier retailers.

Failure to comply with these recommendations may result in the need for unscheduled maintenance. ◀

تلفن شبانه روزی: ۰۲۱-۸۸۸۶۲۰۸۵

FarmaSOS.com

Wheels and tires

Vehicle features and options

This chapter describes all standard, country-specific and optional features offered with the series. It also describes features that are not necessarily available in your car, e. g., due to the selected options or country versions. This also applies to safety-related functions and systems. The respectively applicable country provisions must be observed when using the respective features and systems.

Tire inflation pressure

Safety information

The tire characteristics and tire inflation pressure influence the following:

- ▷ The service life of the tires.
- ▷ Road safety.
- ▷ Driving comfort.

Checking the tire inflation pressure



WARNING

A tire with low or missing tire inflation pressure impacts handling, such as steering and braking response. There is risk of an accident. Regularly check the tire inflation pressure, and correct it as needed, e.g. twice a month and before a long trip. ◀

Also check the tire inflation pressure of the emergency wheel in the trunk regularly, and correct it as needed.

Tires have a natural, consistent loss of tire inflation pressure.

Tires heat up while driving, and the tire inflation pressure increases along with the tire's temperature. The tire inflation pressure specifications relate to cold tires or tires with the ambient temperature.

Only check the tire inflation pressure when the tires are cold. This means after driving no more than 1.25 miles/2 km or when the vehicle has been parked for at least 2 hours.

The displays of inflation devices may under-read by up to 0.1 bar, 2 psi.

For Flat Tire Monitor: after correcting the tire inflation pressure, reinitialize the Flat Tire Monitor.

For Tire Pressure Monitor: after correcting the tire inflation pressure, reset the Tire Pressure Monitor.

Tire inflation pressure specifications

The tire inflation pressure table, refer to page 209, contains all tire inflation pressure specifications for the specified tire sizes at the ambient temperature. The tire inflation pressure values apply to tire sizes approved by the manufacturer of the vehicle for the vehicle type.

To identify the correct tire inflation pressure, please note the following:

- ▷ Tire sizes of your vehicle.
- ▷ Maximum permitted driving speed.

Tire inflation pressures up to 100 mph/160 km/h

For speeds of up to 100 mph/160 km/h and for optimum driving comfort, note the pressure values in the tire inflation pressure table, refer to page 209, and adjust as necessary.

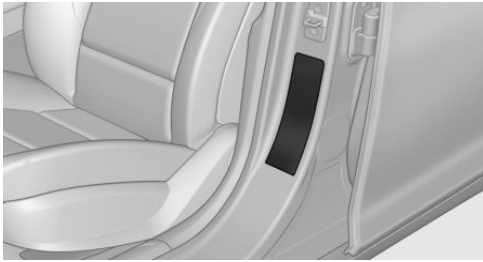

These pressure values can also be found on the tire inflation pressure label on the driver's door pillar.

Do not exceed a speed of 100 mph/160 km/h.

Tire inflation pressure values up to 100 mph/160 km/h

X6 sDrive35i, X6 xDrive35i

Tire size	Pressure specifications in bar/PSI	
Specifications in bar/PSI with cold tires		
255/50 R 19 107 H M+S XL A/S RSC	2.2 / 32	2.6 / 38
255/50 R 19 107 H M+S XL RSC		
Front: 255/50 R 19 107 W XL RSC	2.2 / 32	-
Rear: 285/45 R 19 111 W XL RSC	-	2.4 / 35
Front: 275/40 R 20 106 W XL RSC	2.2 / 32	-
Rear: 315/35 R 20 110 W XL RSC	-	2.4 / 35
Front: 275/40 R 20 106 V M+S XL RSC	2.2 / 32	-
Rear: 315/35 R 20 110 V M+S XL RSC	-	2.4 / 35

Tire size	Pressure specifications in bar/PSI	
Front: 285/35 R 21 105 Y XL RSC	2.4 / 35	-
Rear: 325/30 R 21 108 Y XL RSC	-	2.6 / 38
Emergency wheel: T 155/90 D 18 113 M	Speed up to a max. of 50 mph / 80 km/h	
T 155/80 R 19 114 M	4.2 / 60	

X6 xDrive50i

Tire size	Pressure specifications in bar/PSI	
Specifications in bar/PSI with cold tires		
255/50 R-19 107 H M+S XL A/S RSC	2.3 / 33	2.8 / 41
255/50 R 19 107 H M+S XL RSC		
Front: 255/50 R 19 107 W XL RSC	2.3 / 33	-
Rear: 285/45 R 19 111 W XL RSC	-	2.6 / 38
Front: 275/40 R 20 106 W XL RSC	2.3 / 33	-
Rear: 315/35 R 20 110 W XL RSC	-	2.6 / 38
Front: 275/40 R 20 106 V M+S XL RSC	2.3 / 33	-
Rear: 315/35 R 20 110 V M+S XL RSC	-	2.6 / 38

Tire size	Pressure specifications in bar/PSI	
Front: 285/35 R 21 105 Y XL RSC	2.5 / 36	- 2.8 / 41
Rear: 325/30 R 21 108 Y XL RSC	-	
Emergency wheel: T 155/90 D 18 113 M	Speed up to a max. of 50 mph / 80 km/h 4.2 / 60	
T 155/80 R 19 114 M		

Tire inflation pressures at max. speeds above 100 mph/160 km/h



WARNING

In order to drive at maximum speeds in excess of 100 mph/160 km/h, please observe, and, if necessary, adjust tire pressures for speeds exceeding 100 mph/160 km/h from the relevant table on the following pages. Otherwise tire damage and accidents could occur.

Tire inflation pressure values over 100 mph/160 km/h

X6 sDrive35i, X6 xDrive35i

Tire size	Pressure specifications in bar/PSI	
Specifications in bar/PSI with cold tires		
255/50 R 19 107 H M+S XL A/S RSC	2.5 / 36	2.9 / 42
255/50 R 19 107 H M+S XL RSC		

Tire size	Pressure specifications in bar/PSI	
Front: 255/50 R 19 107 W XL RSC	2.5 / 36	- 2.7 / 39
Rear: 285/45 R 19 111 W XL RSC	-	
Front: 275/40 R 20 106 W XL RSC	2.7 / 39	- 2.9 / 42
Rear: 315/35 R 20 110 W XL RSC	-	
Front: 275/40 R 20 106 V M+S XL RSC	2.7 / 39	- 2.9 / 42
Rear: 315/35 R 20 110 V M+S XL RSC	-	
Front: 285/35 R 21 105 Y XL RSC	2.7 / 39	- 3.1 / 45
Rear: 325/30 R 21 108 Y XL RSC	-	
Emergency wheel: T 155/90 D 18 113 M	Speed up to a max. of 50 mph / 80 km/h 4.2 / 60	
T 155/80 R 19 114 M		

X6 xDrive50i

Tire size	Pressure specifications in bar/PSI	
Specifications in bar/PSI with cold tires		
255/50 R 19 107 H M+S XL A/S RSC	2.8 / 41	3.2 / 46
255/50 R 19 107 H M+S XL RSC		

Tire size	Pressure specifications in bar/PSI	
Front: 255/50 R 19 107 W XL RSC	2.8 / 41	- 3.1 / 45
Rear: 285/45 R 19 111 W XL RSC		
Front: 275/40 R 20 106 W XL RSC	3.0 / 44	- 3.2 / 46
Rear: 315/35 R 20 110 W XL RSC		
Front: 275/40 R 20 106 V M+S XL RSC	3.0 / 44	- 3.2 / 46
Rear: 315/35 R 20 110 V M+S XL RSC		
Front: 285/35 R 21 105 Y XL RSC	3.0 / 44	- 3.4 / 49
Rear: 325/30 R 21 108 Y XL RSC		
Emergency wheel: T 155/90 D 18 113 M	Speed up to a max. of 50 mph / 80 km/h	
T 155/80 R 19 114 M	4.2 / 60	

Tire identification marks

Tire size

245/45 R 18 96 Y

245: nominal width in mm

45: aspect ratio in %

R: radial tire code

18: rim diameter in inches

96: load rating, not for ZR tires

Y: speed rating, before the R on ZR tires

Speed letter

Q = up to 100 mph, 160 km/h

R = up to 106 mph, 170 km/h

S = up to 112 mph, 180 km/h

T = up to 118 mph, 190 km/h

H = up to 131 mph, 210 km/h

V = up to 150 mph, 240 km/h

W = up to 167 mph, 270 km/h

Y = up to 186 mph, 300 km/h

Tire Identification Number

DOT code: DOT xxxx xxx 0115

xxxx: manufacturer code for the tire brand

xxx: tire size and tire design

0115: tire age

Tires with DOT codes meet the guidelines of the U.S. Department of Transportation.

Tire age

DOT ... 0115: the tire was manufactured in the 1st week of 2015.

Recommendation

Regardless of wear and tear, replace tires at least every 6 years.

Uniform Tire Quality Grading

Quality grades can be found where applicable on the tire sidewall between tread shoulder and maximum section width.

For example: Treadwear 200; Traction AA; Temperature A

DOT Quality Grades

Treadwear

Traction AA A B C

Temperature A B C

All passenger car tires must conform to Federal Safety Requirements in addition to these grades.

Treadwear

The treadwear grade is a comparative rating based on the wear rate of the tire when tested

under controlled conditions on a specified government test course. For example, a tire graded 150 would wear one and one-half, 1 g, times as well on the government course as a tire graded 100. The relative performance of tires depends upon the actual conditions of their use, however, and may depart significantly from the norm due to variations in driving habits, service practices and differences in road characteristics and climate.

Traction

The traction grades, from highest to lowest, are AA, A, B, and C.

Those grades represent the tire's ability to stop on wet pavement as measured under controlled conditions on specified government test surfaces of asphalt and concrete. A tire marked C may have poor traction performance.

The traction grade assigned to this tire is based on straight-ahead braking traction tests, and does not include acceleration, cornering, hydroplaning, or peak traction characteristics.

Temperature

The temperature grades are A, the highest, B, and C, representing the tire's resistance to the generation of heat and its ability to dissipate heat when tested under controlled conditions on a specified indoor laboratory test wheel. Sustained high temperature can cause the material of the tire to degenerate and reduce tire life, and excessive temperature can lead to sudden tire failure. The grade C corresponds to a level of performance which all passenger car tires must meet under the Federal Motor Vehicle Safety Standard No. 109. Grades Band A represent higher levels of performance on the laboratory test wheel than the minimum required by law.

WARNING

The temperature grade for this tire is established for a tire that is properly inflated and not overloaded. Excessive speed, underinflation, or excessive loading, either separately or

in combination, can cause heat buildup and possible tire failure. ◀

RSC – Run-flat tires

Run-flat tires, refer to page 214, are labeled with a circular symbol containing the letters RSC marked on the sidewall.

M+S

Winter and all-season tires with better cold weather performance than summer tires.

Tire tread

Summer tires

Do not drive with a tire tread depth of less than 0.12 in/3 mm.

There is an increased danger of hydroplaning if the tire tread depth is less than 0.12 in/3 mm.

Winter tires

Do not drive with a tire tread depth of less than 0.16 in/4 mm.

Below a tread depth of 0.16 in/4 mm, tires are less suitable for winter operation.

Minimum tread depth

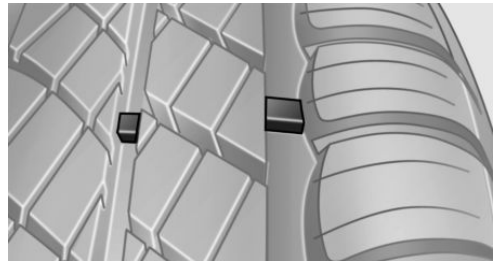

Wear indicators are distributed around the tire's circumference and have the legally required minimum height of 0.063 in/1.6 mm.

They are marked on the side of the tire with TWI, Tread Wear Indicator.

Tire damage

General information

Inspect your tires often for damage, foreign objects lodged in the tread, and tread wear.

Information

Driving over rough or damaged road surfaces, as well as debris, curbs and other obstacles can cause serious damage to wheels, tires and suspension parts. This is more likely to occur with low-profile tires, which provide less cushioning between the wheel and the road. Be careful to avoid road hazards and reduce your speed, especially if your vehicle is equipped with low-profile tires.

Indications of tire damage or other vehicle malfunctions:

- ▷ Unusual vibrations while driving.
- ▷ Unusual handling such as a strong tendency to pull to the left or right.

Damage can, e. g., be caused by driving over curbs, road damage, or similar things.

WARNING

Damaged tires can lose tire inflation pressure, which can lead to loss of vehicle control. There is risk of an accident. If tire damage is suspected while driving, immediately reduce speed and stop. Have wheels and tires checked. For this purpose, drive carefully to the nearest dealer's service center or another qualified service center or repair shop. Have vehicle towed or transported as needed. ◀

WARNING

Damaged tires can lose tire inflation pressure, which can lead to loss of vehicle control. There is risk of an accident. Do not repair damaged tires, but have them replaced. ◀

Changing wheels and tires

Mounting

Have mounting and wheel balancing carried out by a dealer's service center or another qualified service center or repair shop.

Wheel and tire combination

You can ask the dealer's service center or another qualified service center or repair shop about the right wheel/tire combination and wheel rim versions for the vehicle.

Incorrect wheel and tire combinations impair the function of a variety of systems such as ABS or DSC.

To maintain good handling and vehicle response, use only tires with a single tread configuration from a single manufacturer.

Following tire damage, have the original wheel and tire combination remounted on the vehicle as soon as possible.

WARNING

Wheels and tires which are not suitable for your vehicle can damage parts of the vehicle, e. g. due to contact with the body due to tolerances despite the same official size rating. There is risk of an accident. ◀

Recommended tire brands



For each tire size, the manufacturer of your vehicle recommends certain tire brands. These can be identified by a star on the tire sidewall.

New tires

Tire traction is not optimal due to manufacturing circumstances when tires are brand-new; they achieve their full traction potential after a break-in time.

Drive conservatively for the first 200 miles/300 km.

Retreaded tires

The manufacturer of your vehicle does not recommend the use of retreaded tires.

WARNING

Retreaded tires can have different tire casing structures. With advanced age the service life can be limited. There is risk of an accident. Do not use retreaded tires. ◀

Winter tires

Winter tires are recommended for operating on winter roads.

Although so-called all-season M+S tires provide better winter traction than summer tires, they do not provide the same level of performance as winter tires.

Maximum speed of winter tires

If the maximum speed of the vehicle is higher than the permissible speed for the winter tires, then a respective symbol is displayed in your field of vision. The plate is available from a dealer's service center or another qualified service center or repair shop.

With mounted winter tires, observe and adhere to the permissible maximum speed.

Run-flat tires

If you are already using run-flat tires, for your own safety you should replace them only with the same kind. No spare tire is available in the case of a flat tire. A dealer's service center or another qualified service center or repair shop will be glad to answer additional questions at any time.

Rotating wheels between axles

Different wear patterns can occur on the front and rear axles depending on individual driving conditions. The tires can be rotated between the axles to achieve even wear. A dealer's service center or another qualified service center or repair shop will be glad to answer additional questions at any time. After rotating, check the tire pressure and correct if needed.

Rotating the tires is not permissible on vehicles with different tire sizes or rim sizes on the front and rear axles.

Storage

Store wheels and tires in a cool, dry place with as little exposure to light as possible.

Always protect tires against all contact with oil, grease and fuels.

Do not exceed the maximum tire inflation pressure indicated on the side wall of the tire.

Run-flat tires

Label

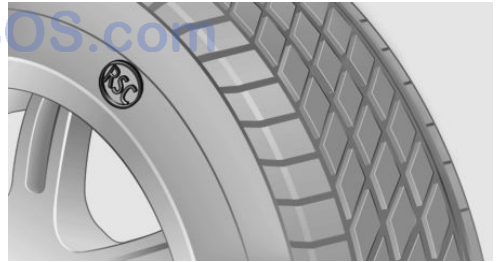

RSC label on the tire sidewall.

The wheels consist of tires that are self-supporting, to a limited degree, and possibly special rims.

The support of the sidewall allows the tire to remain drivable to a restricted degree in the event of a tire inflation pressure loss.

Follow the instructions for continued driving with a flat tire.

Changing run-flat tires

For your own safety, only use run-flat tires. No spare tire is available in the case of a flat tire. A dealer's service center or another qualified service center or repair shop will be glad to answer additional questions at any time.

Mobility System

The concept

With the Mobility System, minor tire damage can be sealed quickly to enable continued travel. To accomplish this, sealant is pumped into the tires, which seals the damage from the inside.

The compressor can be used to check the tire inflation pressure.

Information

- ▶ Follow the instructions on using the Mobility System found on the compressor and sealant container.
- ▶ Use of the Mobility System may be ineffective if the tire puncture measures approx. 1/8 in/4 mm or more.
- ▶ Contact a dealer's service center or another qualified service center or repair shop if the tire cannot be made drivable.
- ▶ If possible, do not remove foreign bodies that have penetrated the tire.
- ▶ Pull the speed limit sticker off the sealant container and apply it to the steering wheel.
- ▶ The use of a sealant can damage the TPM wheel electronics. In this case, have the electronics checked at the next opportunity and have them replaced if needed.



DANGER

If the exhaust pipe is blocked or ventilation is insufficient, harmful exhaust gases can enter into the vehicle. The exhaust gases contain carbon monoxide, an odorless and color-

less but highly toxic gas. In enclosed areas, exhaust gases can also accumulate outside of the vehicle. There is danger to life. Keep the exhaust pipe free and ensure sufficient ventilation. ◀

Storage

The Mobility System is located under the cargo floor panel.

Sealant container



- ▶ Sealant container, arrow 1.
- ▶ Filling hose, arrow 2.

Observe use-by date on the sealant container.

Compressor

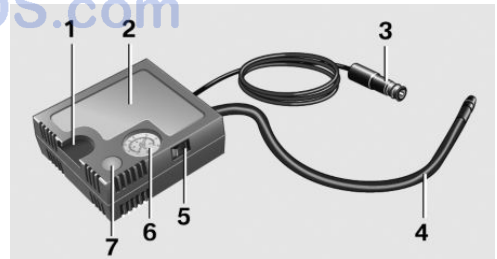

- 1 Holder for bottle
- 2 Compressor
- 3 Connector/cable for socket
- 4 Connection hose
- 5 On/off switch
- 6 Inflation pressure dial
- 7 Reduce inflation pressure

Filling the tire with sealant

1. Shake the sealant container.



2. Pull the connection hose fully out of the compressor housing. Do not kink the hose.

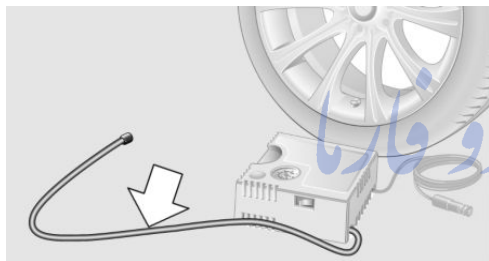

3. Screw the connection hose onto the connector of the sealant container.

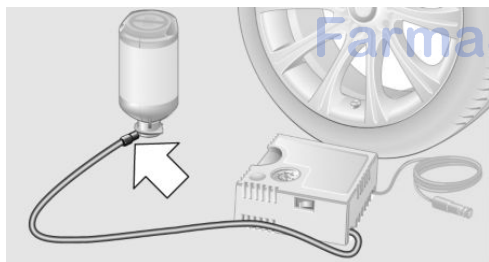

4. Insert the sealant container on the compressor housing in an upright position.

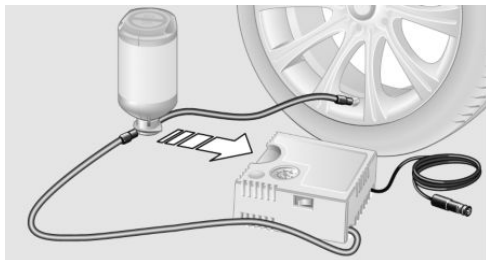

5. Screw the filling hose of the sealant container onto the tire valve of the nonworking wheel.



6. With the compressor switched off, insert the plug into the power socket inside the vehicle.

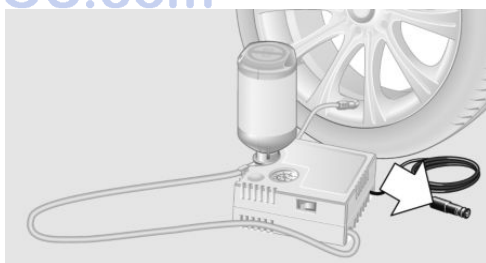

- With the ignition turned on or the engine running, switch on the compressor.

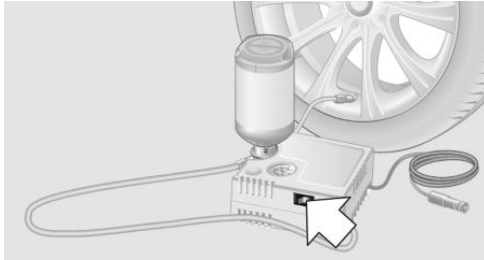

CAUTION

The compressor can overheat during extended operation. There is risk of property damage. Do not run the compressor for more than 10 min. ◀

Let the compressor run for approx. 3 to 8 minutes to fill the tire with sealant and achieve a tire inflation pressure of approx. 2.5 bar.

While the tire is being filled with sealant, the tire inflation pressure may sporadically reach approx. 5 bar. Do not switch off the compressor at this point.

If a tire inflation pressure of 2 bar is not reached:

- Switch off the compressor.
- Unscrew the filling hose from the wheel.
- Drive 33 ft/10 m forward and back to distribute the sealant in the tire.
- Inflate the tire again using the compressor.

If a tire inflation pressure of 2 bar cannot be reached, contact your dealer's service center or another qualified service center or repair shop.

Stowing the Mobility System

- Unscrew the filling hose of the sealant container from the wheel.
- Unscrew the connection hose of the compressor from the sealant container.
- Connect the filling hose of the sealant container previously connected to the tire

valve with the available connector on the sealant container.

This prevents leftover sealant from escaping from the container.

- Wrap the empty sealant container in suitable material to avoid dirtying the trunk.
- Stow the Mobility System back in the vehicle.

Distributing the sealant

Immediately drive approx. 5 miles/10 km to ensure that the sealant is evenly distributed in the tire.

Do not exceed a speed of 50 mph/80 km/h.

If possible, do not drive at speeds less than 12 mph/20 km/h.

To correct the tire inflation pressure

- Stop at a suitable location.
- Screw the connection hose of the compressor directly onto the tire valve stem.
- Insert the connector into the power socket inside the vehicle.
- Correct the tire inflation pressure to 2.5 bar.
 - ▶ Increase pressure: with the ignition turned on or the engine running, switch on the compressor.
 - ▶ To reduce the pressure: press the button on the compressor.

Continuing the trip

Do not exceed the maximum permissible speed of 50 mph/80 km/h.

Reinitialize the Flat Tire Monitor.

Reinitialize the Tire Pressure Monitor.

Replace the nonworking tire and the sealant container of the Mobility System as soon as possible.

Snow chains

Fine-link snow chains

The manufacturer of your vehicle recommends use of fine-link snow chains. Certain types of fine-link snow chains have been tested by the manufacturer of the vehicle and recommended as road-safe and suitable.

Information regarding suitable snow chains is available from a dealer's service center or another qualified service center or repair shop.

Use

Use only in pairs on the rear wheels, equipped with the tires of the following size:

- ▷ 255/50 R 19.

Follow the snow chain manufacturer's instructions.

Make sure that the snow chains are always sufficiently tight. Retighten as needed according to the chain manufacturer's instructions.

Do not initialize the Flat Tire Monitor after mounting snow chains, as doing so may result in incorrect readings.

Do not initialize the Tire Pressure Monitor after mounting snow chains, as doing so may result in incorrect readings.

When driving with snow chains, briefly activate Dynamic Traction Control if needed.

Maximum speed with snow chains

Do not exceed a speed of 30 mph/50 km/h when using snow chains.

Engine compartment

Vehicle features and options

This chapter describes all standard, country-specific and optional features offered with the series. It also describes features that are not necessarily available in your car, e. g., due to

the selected options or country versions. This also applies to safety-related functions and systems. The respectively applicable country provisions must be observed when using the respective features and systems.

Important features in the engine comp.

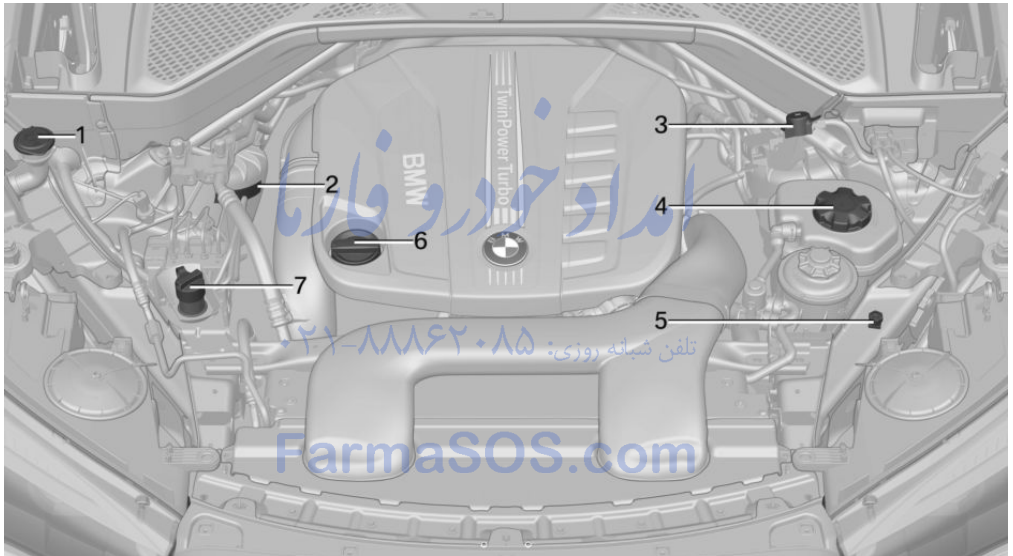

- | | |
|---|--|
| <p>1 Washer fluid reservoir</p> <p>2 Vehicle identification number</p> <p>3 Jump-starting, positive battery terminal</p> <p>4 Coolant reservoir</p> | <p>5 Jump-starting, negative battery terminal</p> <p>6 Oil filler neck</p> <p>7 Diesel engine:
Container for diesel exhaust fluid</p> |
|---|--|

Hood

Information



WARNING

Improperly executed work in the engine compartment can damage components and lead to a safety risk. There is risk of accidents or risk of property damage. ◀



WARNING

The engine compartment accommodates moving components. Certain components can move in the engine compartment with the vehicle switched off, e.g. the cooler fan. There is risk of injuries. Do not reach into the area of moving parts. Keep articles of clothing and hair away from moving parts. ◀



CAUTION

Folded-away wipers can be jammed when the hood is opened. There is risk of property damage. Make sure that the wipers with the wiper blades mounted are folded down onto the windshield before opening the hood. ◀



WARNING

There are protruding parts, e.g. lock hook, on the inside of the hood. There is risk of injuries. If the hood is open, pay attention to protruding parts and keep these areas clear. ◀



WARNING

An incorrectly locked hood can open while driving and restrict visibility. There is risk of an accident. Stop immediately and correctly close the hood. ◀



WARNING

Body parts can be jammed on opening and closing the hood. There is risk of injuries. Make sure that the area of movement of the hood is clear during opening and closing. ◀

Opening the hood

1. Pull the lever.

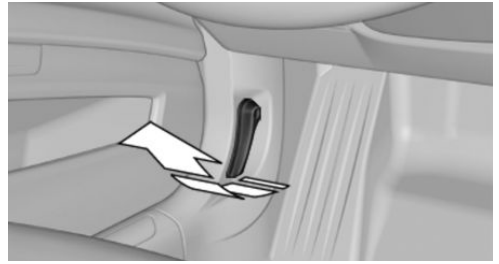

2. Press the release handle and open the hood.

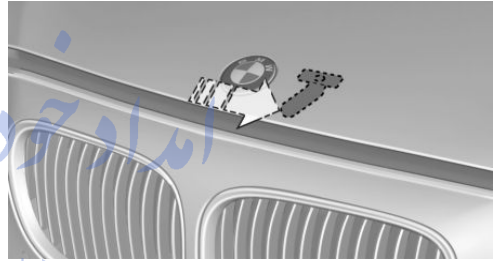

3. Be careful of protruding parts on the hood.



Closing the hood

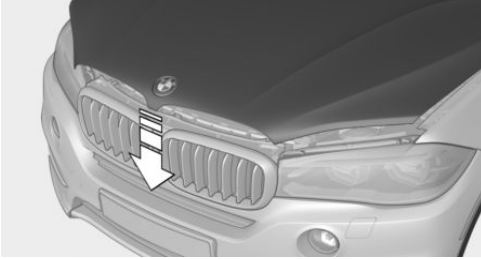

Let the hood drop from a height of approx. 16 in/40 cm and push down on it to lock it fully.

The hood must audibly engage on both sides.

امداد خودرو فارما

تلفن شبانه روزی: ۰۲۱-۸۸۸۶۲۰۸۵

FarmaSOS.com

Engine oil

Vehicle features and options

This chapter describes all standard, country-specific and optional features offered with the series. It also describes features that are not necessarily available in your car, e. g., due to the selected options or country versions. This also applies to safety-related functions and systems. The respectively applicable country provisions must be observed when using the respective features and systems.

General information

The engine oil consumption is dependent on the driving style and driving conditions.

The engine oil consumption can increase in the following situations, for example:

- ▷ Sporty driving style.
- ▷ Break-in of the engine.
- ▷ Idling of the engine.
- ▷ With use of engine oil types that are not approved.

Therefore, regularly check the engine oil level after refueling.

The vehicle is equipped with electronic oil measurement.

The electronic oil measurement has two measuring principles:

- ▷ Status display
- ▷ Detailed measurement

Electronic oil measurement

Status display

The concept

The engine oil level is monitored electronically while driving and shown on the Control Display.

If the engine oil level reaches the minimum level, a check control message is displayed.

Requirements

A current measured value is available after approx. 30 minutes of driving. During a shorter trip, the status of the last, sufficiently long trip is displayed.

With frequent short-distance trips, regularly perform a detailed measurement.

Displaying the engine oil level

On the Control Display:

1. "Vehicle info"
2. "Vehicle status"
3.  "Engine oil level"

Engine oil level display messages



CAUTION

A too low engine oil level causes engine damage. There is risk of property damage. Immediately add engine oil. ◀

Take care not to add too much engine oil.



CAUTION

Too much engine oil can damage the engine or the catalytic converter. There is risk of property damage. Do not add too much engine oil. Have too much engine oil siphoned off by a dealer's service center or another qualified service center or repair shop. ◀

Different messages appear on the display depending on the engine oil level. Pay attention to these messages.

If the engine oil level is too low, within the next 125 miles/200 km Add engine oil, refer to page 223.

Detailed measurement

The concept

In the detailed measurement the engine oil level is checked and displayed via a scale.

Gasoline engine:

If the engine oil level reaches the minimum level, a check control message is displayed.

During the measurement, the idle speed is increased somewhat.

Requirements

- ▶ Vehicle is on level road.
- ▶ Steptronic transmission: selector lever in selector lever position N or P and accelerator pedal not depressed.
- ▶ Engine is running and is at operating temperature.

Performing a detailed measurement

In order to perform a detailed measurement of the engine oil level:

1. "Vehicle info"
2. "Vehicle status"
3.  "Measure engine oil level"
4. "Start measurement"

The engine oil level is checked and displayed via a scale.

Time: approx. 1 minute.

Adding engine oil

Information



CAUTION

A too low engine oil level causes engine damage. There is risk of property damage.

Add engine oil within the next 125 miles/200 km. ◀



CAUTION

Too much engine oil can damage the engine or the catalytic converter. There is risk of property damage. Do not add too much engine oil. Have too much engine oil siphoned off by a dealer's service center or another qualified service center or repair shop. ◀



WARNING

Operating materials, e.g. oils, greases, coolants, fuels, can contain harmful ingredients. There is risk of injuries or danger to life. Observe the instructions on the containers. Avoid the contact of articles of clothing, skin or eyes with operating materials. Do not refill operating materials into different bottles. Store operating materials out of reach of children. ◀

General information

Only add engine oil when the message is displayed in the instrument cluster. The quantity to be added is indicated in the message displayed in the instrument cluster.

Switch off the ignition and safely park the vehicle before engine oil is added.

Overview

The oil filler neck is located in the engine compartment, refer to page 219.

Opening the oil filler neck

1. Opening the hood, refer to page 220

- Turn the oil filler neck counter-clockwise.

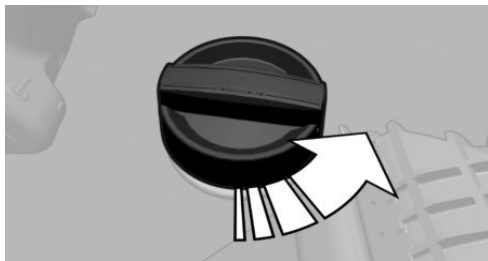

- Add motor oil.

Engine oil types to add

Information

CAUTION

Oil additives can damage the engine. There is risk of property damage. Do not use oil additives. ◀

CAUTION

Incorrect engine oil can cause malfunctions in the engine or damage it. There is risk of property damage. When selecting an engine oil, make sure that the engine oil has the correct viscosity grade. ◀

The engine oil quality is critical for the life of the engine.

Viscosity grades

When selecting an engine oil, ensure that the engine oil belongs to one of the viscosity grades SAE 0W-40, SAE 0W-30, SAE 5W-40, SAE 5W-30, 0W-20 or 5W-20.

The viscosity grades 0W-20 and 5W-20 are only suitable for particular engines.

Suitable engine oil types

Add engine oils that meet the following oil rating standards:

Gasoline engine

BMW Longlife-01.

BMW Longlife-01 FE.

BMW Longlife-14 FE+.

The oil rating BMW Longlife-14 FE+ is only suitable for particular gasoline motors.

More information about suitable engine oil ratings and viscosities of engine oils can be requested from a dealer's service center or another qualified service center or repair shop.

Alternative engine oil types

If an engine oil suitable for continuous use is not available, up to 1 US quart/liter of an engine oil with the following oil rating can be added:

Gasoline engine

API SL or superior oil rating.

Engine oil change

CAUTION

Engine oil that is not changed in timely fashion can cause increased engine wear and thus engine damage. There is risk of property damage. Do not exceed the service data indicated in the vehicle. ◀

The vehicle manufacturer recommends that you let the dealer's service center or another qualified service center or repair shop change the motor oil.

BMW recommends
Original BMW Engine Oil.

امداد خودرو فارما

تلفن شبانه روزی: ۰۲۱-۸۸۸۶۲۰۸۵

FarmaSOS.com

Coolant

Vehicle features and options

This chapter describes all standard, country-specific and optional features offered with the series. It also describes features that are not necessarily available in your car, e. g., due to the selected options or country versions. This also applies to safety-related functions and systems. The respectively applicable country provisions must be observed when using the respective features and systems.

Information

WARNING

With the engine hot and the cooling system open, coolant can escape and lead to burns. There is risk of injuries. Only open the cooling system with the engine cooled down. ◀

WARNING

Additives are harmful and incorrect additives can damage the engine. There is risk of injuries and risk of property damage. Avoid the contact of articles of clothing, skin or eyes with additives. Do not swallow any additives. Use suitable additives only. ◀

Coolant consists of water and additives.

Not all commercially available additives are suitable for the vehicle. Information about suitable additives is available from a dealer's service center or another qualified service center or repair shop.

Coolant level

General information

If there is no Min. and Max. mark in the filler neck of the coolant reservoir, have the coolant level checked if needed by your dealer's serv-

ice center or another qualified service center or repair shop and add coolant as needed.

Overview

Depending on the engine installation, the coolant reservoir is located on the right side or the left side of the engine compartment.

Checking

1. Let the engine cool.
2. Turn the lid of the coolant reservoir slightly counterclockwise to allow any excess pressure to dissipate, then open it.

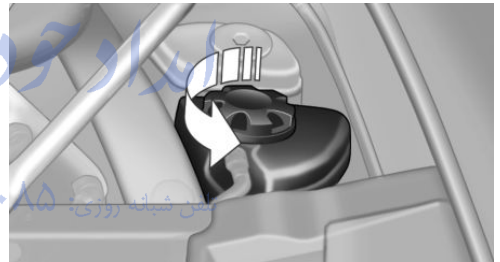

3. Open the coolant reservoir lid.
4. The coolant level is correct if it lies between the minimum and maximum marks in the filler neck.



Adding

1. Let the engine cool.
2. Turn the lid of the coolant reservoir slightly counterclockwise to allow any excess pressure to dissipate, then open it.



3. If the coolant is low, slowly add coolant up to the specified level; do not overfill.
4. Turn the lid until there is an audible click. The arrows on the coolant reservoir and the lid must point towards one another.
5. Have the cause of the coolant loss eliminated as soon as possible.

Disposal



Comply with the relevant environmental protection regulations when disposing of coolant and coolant additives.

تلفن شبانه روزی: ۰۲۱-۸۸۸۶۲۰۸۵

ParmaSOS.com

Maintenance

Vehicle features and options

This chapter describes all standard, country-specific and optional features offered with the series. It also describes features that are not necessarily available in your car, e. g., due to the selected options or country versions. This also applies to safety-related functions and systems. The respectively applicable country provisions must be observed when using the respective features and systems.

BMW maintenance system

The maintenance system indicates required maintenance measures, and thereby provides support in maintaining road safety and the operational reliability of the vehicle.

In some cases scopes and intervals may vary according to the country-specific version. Replacement work, spare parts, fuels and lubricants and wear materials are calculated separately. Further information is available from a dealer's service center or another qualified service center or repair shop.

Condition Based Service CBS

Sensors and special algorithms take into account the driving conditions of your vehicle. Based on this, Condition Based Service recognizes the maintenance requirements.

The system makes it possible to adapt the amount of maintenance corresponding to your user profile.

Detailed information on service requirements, refer to page 92, can be displayed on the Control Display.

Service data in the remote control

Information on the required maintenance is continuously stored in the remote control. The dealer's service center can read this data out and suggest an optimized maintenance scope for your vehicle.

Therefore, hand the service advisor the remote control with which the vehicle was driven most recently.

Storage periods

Storage periods during which the vehicle battery was disconnected are not taken into account.

If this occurs, have a dealer's service center or another qualified service center or repair shop update the time-dependent maintenance procedures, such as checking brake fluid and, if necessary, changing the engine oil and the microfilter/activated-charcoal filter.

Service and Warranty Information Booklet for US models and Warranty and Service Guide Booklet for Canadian models

Please consult your Service and Warranty Information Booklet for US models and Warranty and Service Guide Booklet for Canadian models for additional information on service requirements.

The manufacturer of your vehicle recommends that maintenance and repair be performed by a dealer's service center or another qualified service center or repair shop. Records of regular maintenance and repair work should be retained.

Socket for OBD Onboard Diagnosis

ontrol components, in particular the catalytic converter.

Information



CAUTION

Improper use of the socket for Onboard Diagnosis can lead to vehicle malfunctions. There is risk of property damage. The manufacturer of your vehicle strongly recommends access to the socket for Onboard Diagnosis be limited to a dealer's service center, another qualified service center or repair shop or other authorized persons. ◀

Position

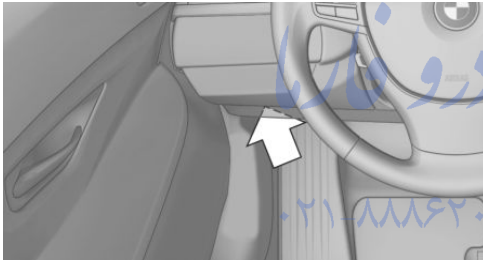

There is an OBD socket on the driver's side for checking the primary components in the vehicle's emissions.

Emissions



- ▶ The warning lamp lights up:
Emissions are deteriorating. Have the vehicle checked as soon as possible.
- ▶ The warning lamp flashes under certain circumstances:
This indicates that there is excessive misfiring in the engine.
Reduce the vehicle speed and have the system checked immediately; otherwise, serious engine misfiring within a brief period can seriously damage emission con-

Replacing components

Vehicle features and options

This chapter describes all standard, country-specific and optional features offered with the series. It also describes features that are not necessarily available in your car, e. g., due to the selected options or country versions. This also applies to safety-related functions and systems. The respectively applicable country provisions must be observed when using the respective features and systems.

Onboard vehicle tool kit

1. Fold up the cargo floor panel.

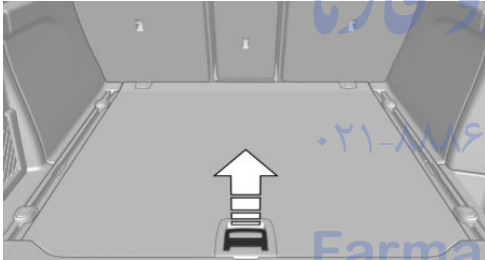

2. Remove the onboard vehicle tool kit.

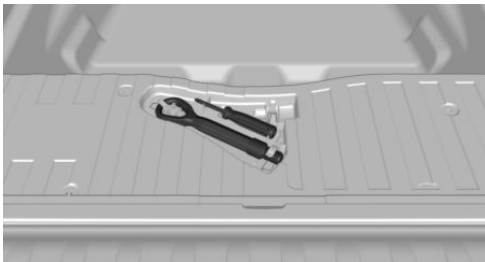

Wiper blade replacement

Information



CAUTION

If the wiper arm falls onto the windshield without the wiper blades installed, the windshield can be damaged. There is risk of property damage. Secure the wiper arm when replacing the wiper blades and do not fold down the wipers without the wiper blades installed. ◀



CAUTION

Folded-away wipers can be jammed when the hood is opened. There is risk of property damage. Make sure that the wipers with the wiper blades mounted are folded down onto the windshield before opening the hood. ◀

Replacing the front wiper blades

1. To change the wiper blades, fold up, refer to page 77, the wiper arms.
2. Lift the wiper all the way off of the windshield.

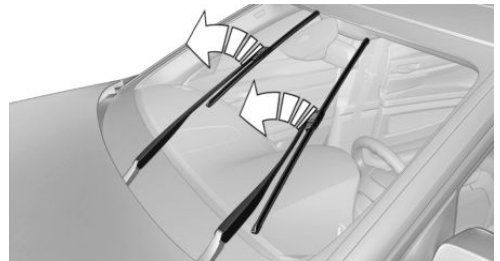

3. Fold open the holder.

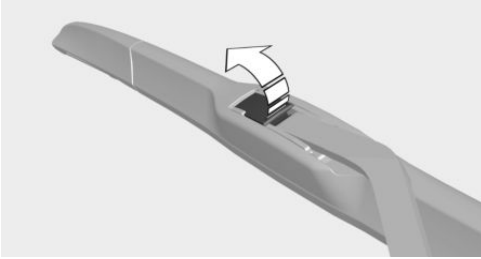

4. Slide wiper blade out of the wiper arm.

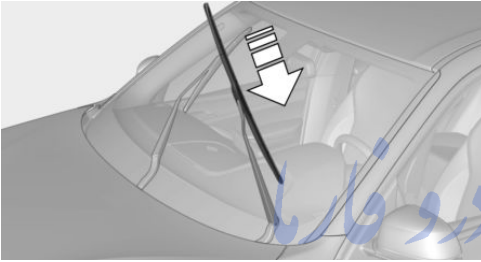

5. Insert the new wiper blade and press it on until you hear it snap into the holder.
6. Fold down the wipers.

Information

Lights and bulbs



WARNING

Bulbs can get hot during operation. Contact with the bulbs can cause burns. There is risk of injuries. Only change bulbs after they have cooled off. ◀



WARNING

Work on switched-on lighting systems can cause short circuits. There is risk of injuries or risk of property damage. When working on the lighting system, switch off the lamps in question. If necessary, heed the bulb manufacturer's instructions. ◀



CAUTION

Contaminated bulbs reduce their service life. There is risk of property damage. Do not hold new bulbs with your bare hands. Use a clean cloth or something similar, or hold the bulb by its base. ◀

Xenon headlights



DANGER

There can be high voltage in the lighting system. There is danger to life. The manufacturer of your vehicle recommends that the work on the lighting system including bulb replacement be performed by a dealer's service center or another qualified service center or repair shop. ◀

Light-emitting diodes (LEDs)

Some items of equipment use light-emitting diodes installed behind a cover as a light source.

These light-emitting diodes, which are related to conventional lasers, are officially designated as Class 1 light-emitting diodes.

Lamp and bulb replacement

General information

Lights and bulbs make an essential contribution to vehicle safety.

The manufacturer of the vehicle recommends that you have appropriate work performed by a dealer's service center or another qualified service center or repair shop if you are unfamiliar with it or if it has not been described here.

A spare lamp box is available from a dealer's service center or another qualified service center or repair shop.

**WARNING**

Too intensive brightness can irritate or damage the retina of the eye. There is risk of injuries. Do not look directly into the headlights or other light sources for an extended period of time. Do not remove the LED covers. ◀

Headlight glass

Condensation can form on the inside of the external lights in cool or humid weather. When driving with the lights switched on, the condensation evaporates after a short time. The headlight glass does not need to be changed.

If despite driving with the lights switched on, increasing humidity forms, e. g. water droplets in the lamp, the manufacturer of your vehicle recommends having it checked by a dealer's service center or another qualified service center or repair shop.

Headlight setting

The headlight adjustments can be affected by changing lights and bulbs. After the headlight adjustment was changed, have it checked and, if necessary, corrected by a dealer's service center or another qualified service center or repair shop.

Front lights, bulb replacement

Xenon headlights

Information

Because of the long service life of these bulbs, the likelihood of failure is very low. Switching the lights on and off frequently shortens their service life.

If a bulb fails, turn on the front fog lights and continue the trip with great care. Comply with local regulations.

**DANGER**

There can be high voltage in the lighting system. There is danger to life. The manufacturer of your vehicle recommends that the

work on the lighting system including bulb replacement be performed by a dealer's service center or another qualified service center or repair shop. ◀

For checking and adjusting headlamp aim, contact a dealer's service center or another qualified service center or repair shop.

Overview

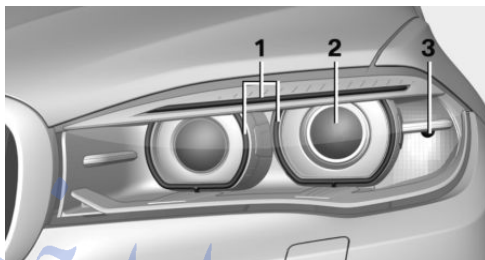

- 1 Parking lights / daytime running lights
- 2 Low beams/high beams/headlight flasher
- 3 Turn signal

Xenon headlights

Low beams and high beams are designed with xenon technology.

The parking lights and daylight running lights are made using LED technology.

Contact a dealer's service center or another qualified service center or repair shop in the event of a malfunction.

LED headlights

With LED headlights, all front lights and side indicators are designed with LED technology.

If an LED fails, switch on the front fog lights and continue the trip with great care. Comply with local regulations.

Contact a dealer's service center or another qualified service center or repair shop in the event of a malfunction.

Turn signal

Information

Follow general instructions, refer to page 231.

Replacement

21-watt bulb, PY 21W.

1. Opening the hood, refer to page 220
2. Unscrew the lid counterclockwise and remove it carefully.

The bulb is attached to the lid.

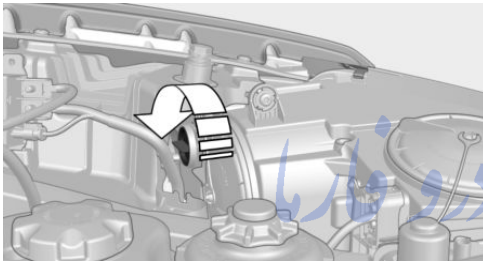

3. Turn the bulb clockwise to remove it.
4. Insert the new bulb and attach the cover in the reverse order.

Turn signal in exterior mirror

The turn signals in the exterior mirrors feature LED technology. Contact a dealer's service center or another qualified service center or repair shop in the event of a malfunction.

Front fog lights/cornering lights

Information

Follow general instructions, refer to page 231.

Replacement

55-watt bulb, H11.

1. Insert the screwdriver from the onboard vehicle tool kit, with the flat side on the clip, arrow 1.

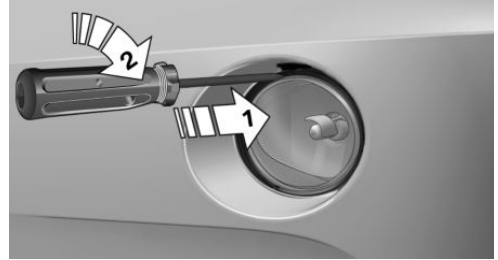

2. Turn the screwdriver by 90°, arrow 2.
3. Remove the front fog lamp toward the front.
4. Detach the connector.

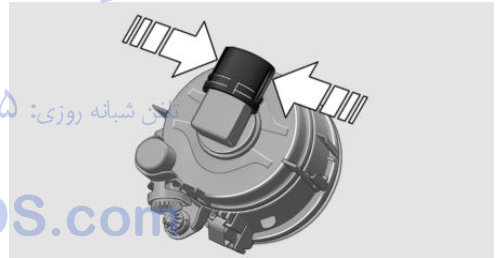

5. Turn the bulb bracket and remove it.

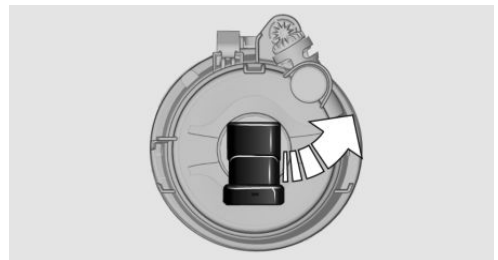

6. Remove the bulb and replace it.
7. Proceed in reverse order to insert the front fog lamp. Note the guide rails in doing so.

LED front fog lights

These front fog lights are made using LED technology. Contact a dealer's service center or another qualified service center or repair shop in the event of a malfunction.

Tail lights, bulb replacement

LED tail lights

These tail lights are made using LED technology. Contact a dealer's service center or another qualified service center or repair shop in the event of a malfunction.

Changing wheels

Information

When using run-flat tires or sealants, a tire does not need to be changed immediately in the event of pressure loss due to a flat tire.

The tools for changing wheels are available as accessories from your dealer's service center or another qualified service center or repair shop.

Jacking points for the vehicle jack

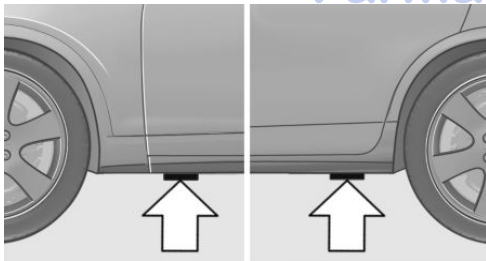

The jacking points for the vehicle jack are located at the positions shown.

Emergency wheel

Safety measures

- ▷ Park the vehicle as far away as possible from passing traffic and on solid ground. Switch on the hazard warning system.
- ▷ Set the parking brake and engage lever in position P P.
- ▷ Have all vehicle occupants get out of the vehicle and ensure that they remain outside the immediate area in a safe place, such as behind a guardrail.
- ▷ If necessary, set up a warning triangle or portable hazard warning lamp at an appropriate distance.
- ▷ Perform wheel change only on a flat, solid and slip-resistant surface. On soft or slippery ground, e.g., snow, ice, tiles, etc., the vehicle or vehicle jack can slip away to the side.
- ▷ Do not place wood blocks or similar items under the vehicle jack; otherwise, it cannot reach its carrying capacity because of the restricted height.
- ▷ If the vehicle is raised, do not lie under the vehicle and do not start the engine; otherwise, a fatal hazard exists.

Information



WARNING

The vehicle jack is optimized for lifting the vehicle and for the jacking points on the vehicle only. There is risk of injuries. Do not lift any other vehicle or cargo using the vehicle jack. ◀

Overview

The emergency wheel and the tools are located in the trunk under the cargo floor panel.

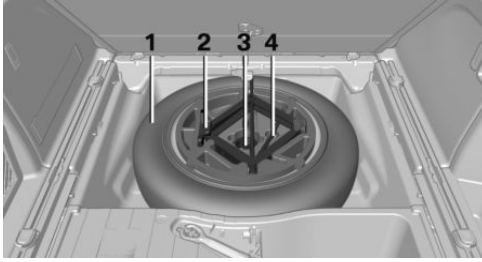

- 1 Emergency wheel
- 2 Vehicle jack
- 3 Vehicle jack crank
- 4 Wheel lug wrench

Removing the emergency wheel

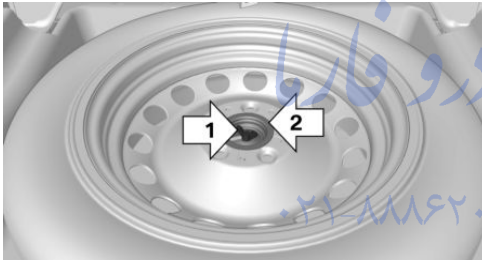

1. Remove tool holder.
2. Unscrew the wing nut 1.
3. Remove the washer 2 to the side.
4. Remove emergency wheel.

Prepare wheel change

1. Follow the Safety instructions, refer to page 234.
2. Loosen the wheel lug bolts a half turn.

Jacking up the vehicle

1. Place the vehicle jack at the jacking point closest to the wheel such that the vehicle jack foot is vertically beneath the vehicle

jacking point with the entire surface on the ground.

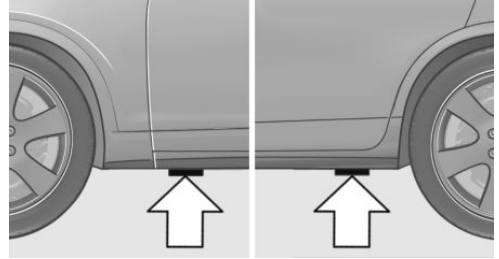

2. Insert the vehicle jack head in the rectangular recess of the jacking point for cranking it up.
3. Crank it up until the wheel in question lifts off of the ground.

Wheel mounting

Mount one emergency wheel only.

1. Unscrew the wheel lug bolts and remove the wheel.
2. Put the new wheel or emergency wheel on and screw in at least two bolts.

If original BMW light alloy wheels are not mounted, any accompanying lug bolts also have to be used.

3. Screw in the remaining the lug bolts and tighten all bolts well in a crosswise pattern.
4. Lower the vehicle and remove the vehicle jack.

After the wheel change

1. Tighten the lug bolts crosswise. The tightening torque is 101 lb ft/140 Nm.
2. Stow the nonworking wheel in the trunk. The nonworking wheel cannot be stored under the cargo floor panel because of its size.
3. Check tire inflation pressure at the next opportunity and correct as needed.
4. Reinitialize the Flat Tire Monitor.

Reset the Tire Pressure Monitor.

5. Check to make sure the lug bolts are tight with a calibrated torque wrench.
6. Replace the damaged tires as soon as possible.

Driving with emergency wheel



WARNING

The emergency wheel has particular dimensions. When driving with an emergency wheel, changed driving properties may occur at higher speeds, e.g. reduced lane stability when braking, longer braking distance and changed self-steering properties in the limit area. There is risk of an accident. Drive moderately and do not exceed a speed of 50 mph/80 km/h. ◀

Vehicle battery

Maintenance

The battery is maintenance-free.

The added amount of acid is sufficient for the service life of the battery.

More information about the battery can be requested from a dealer's service center or another qualified service center or repair shop.

Battery replacement



CAUTION

Vehicle batteries that are not compatible can damage vehicle systems and impair vehicle functions. There is risk of property damage. Information on the compatible vehicle batteries is available at your dealer's service center. ◀

After a battery replacement, the manufacturer of your vehicle recommends that the vehicle battery be registered on the vehicle by a dealer's service center or another qualified service center or repair shop to ensure that all comfort features are fully available and that any

Check Control messages of these comfort features are no longer displayed.

Charging the battery

General information

Make sure that the battery is always sufficiently charged to guarantee that the battery remains usable for its full service life.

The battery may need to be charged in the following cases:

- ▷ When making frequent short-distance drives.
- ▷ If the vehicle is not used for prolonged periods, longer than a month.

Information



CAUTION

Battery chargers for the vehicle battery can work with high voltages and currents, which means that the 12V on-board network can be overloaded or damaged. There is risk of property damage. Only connect battery chargers for the vehicle battery to the starting aid terminals in the engine compartment. ◀

Starting aid terminals

In the vehicle, only charge the battery via the starting aid terminals, refer to page 240, in the engine compartment with the engine off.

Power failure

After a temporary power loss, some equipment needs to be newly initialized or individual settings updated, e. g.:

- ▷ Seat, mirror, and steering wheel memory: store the positions again.
- ▷ Time: update.
- ▷ Date: update.
- ▷ Glass sunroof: initialize the system, refer to page 51.

Disposing of old batteries



Have old batteries disposed of by a dealer's service center or another qualified service center or repair shop or take them to a collection point.

Maintain the battery in an upright position for transport and storage. Secure the battery so that it does not tip over during transport.

Fuses

Information



WARNING

Incorrect and repaired fuses can overload electrical lines and components. There is risk of fire. Never attempt to repair a blown fuse and do not replace a nonworking fuse with a substitute of another color or amperage rating. ◀

Plastic tweezers and information on the fuse types and locations are stored in the fuse box in the trunk.

In the car's interior



Loosen fasteners, arrows, and open cover.

In the trunk

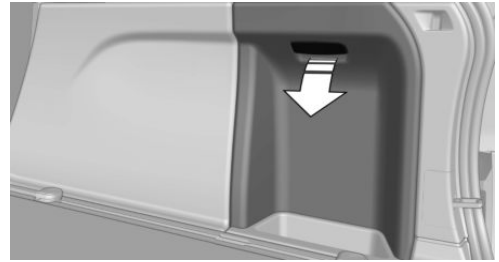

Open the cover on the right side trim, arrow.

Information on the fuse types and locations is found on a separate sheet.

Breakdown assistance

Vehicle features and options

This chapter describes all standard, country-specific and optional features offered with the series. It also describes features that are not necessarily available in your car, e. g., due to the selected options or country versions. This also applies to safety-related functions and systems. The respectively applicable country provisions must be observed when using the respective features and systems.

Hazard warning flashers

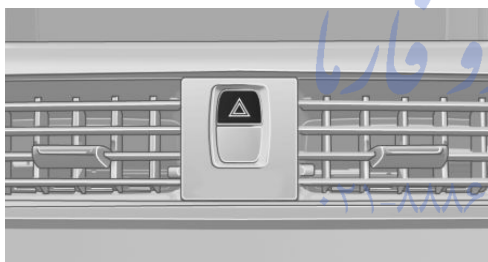

The button is located in the center console.

Intelligent Emergency Request

The concept

In case of an emergency, an Emergency Request can be made through this system.

General information

Only press the SOS button in an emergency.

For technical reasons, the Emergency Request cannot be guaranteed under unfavorable conditions.

Overview



SOS button in the roofliner

Requirements

- ▶ The SIM card integrated in the vehicle has been activated.
- ▶ The radio-ready state is switched on.
- ▶ The Assist system is functional.

Initiating an Emergency Request

1. Press the cover briefly to open it.
2. Press the SOS button until the LED at the button lights up green.
 - ▶ The LED lights up green: an Emergency Request was initiated.

If a cancel prompt appears on the display, the Emergency Request can be aborted.

If the situation allows, wait in your vehicle until the voice connection has been established.

- ▶ The LED flashes green when a connection to the BMW Response Center has been established.

When the emergency request is received at the BMW Response Center, the BMW Response Center contacts you and takes further steps to help you.

Even if you are unable to respond, the BMW Response Center can take further

steps to help you under certain circumstances.

For this, data are transmitted to the BMW Response Center which serve to determine the necessary rescue measures. E. g. the current position of the vehicle, if it can be established.

- ▶ If the LED is flashing green, but the BMW Response Center can no longer be heard via the speaker, you can nevertheless still be heard at the BMW Response Center.

Initiating an Emergency Request automatically

Under certain conditions, an Emergency Request is automatically initiated immediately after a severe accident. Automatic Collision Notification is not affected by pressing the SOS button.

Warning triangle

1. Open the cover on the left side trim.

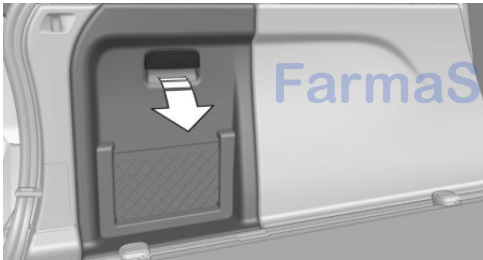

2. Lift the warning triangle slightly and remove in the direction of the interior.

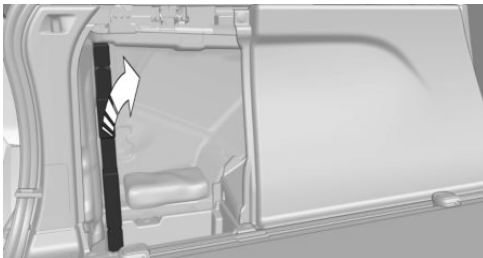

First-aid kit

Information

Some of the articles have a limited service life. Check the expiration dates of the contents regularly and replace any expired items promptly.

Storage

1. Open the cover on the left side trim.

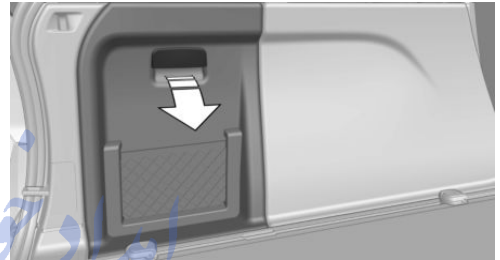

2. Remove the first-aid kit.

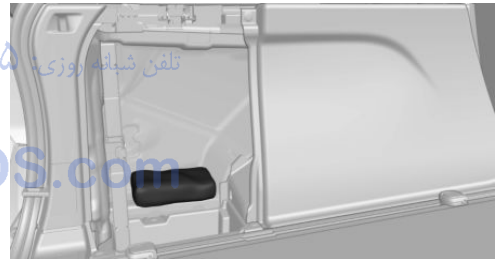

Jump-starting

General information

If the battery is discharged, the engine can be started using the battery of another vehicle and two jumper cables. Only use jumper cables with fully insulated clamp handles.

Information



DANGER

Contact with live components can lead to an electric shock. There is risk of injuries or danger to life. Do not touch any components that are under voltage. ◀

To prevent personal injury or damage to both vehicles, adhere strictly to the following procedure.

Preparation



CAUTION

In the case of body contact between the two vehicles, a short circuit can occur during jump-starting. There is risk of property damage. Make sure that no body contact occurs. ◀

1. Check whether the battery of the other vehicle has a voltage of 12 volts. This information can be found on the battery.
2. Switch off the engine of the assisting vehicle.
3. Switch off any electronic systems/power consumers in both vehicles.

Starting aid terminals



WARNING

If the jumper cables are connected in the incorrect order, sparks formation can occur. There is risk of injuries. Pay attention to the correct order during connection. ◀

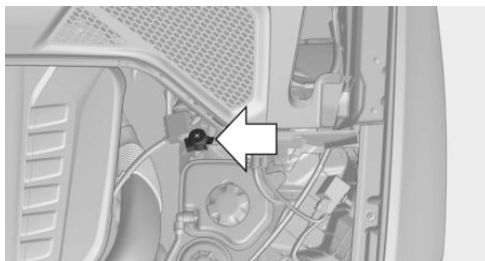

The so-called starting aid terminal in the engine compartment acts as the battery's positive terminal.

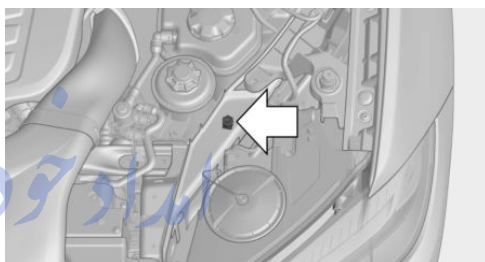

The body ground or a special nut acts as the battery negative terminal.

Connecting the cables

1. Open the cover of the BMW starting aid terminal.
2. Attach one terminal clamp of the positive jumper cable to the positive terminal of the battery, or to the corresponding starting aid terminal of the vehicle providing assistance.
3. Attach the terminal clamp on the other end of the cable to the positive terminal of the battery, or to the corresponding starting aid terminal of the vehicle to be started.
4. Attach one terminal clamp of the negative jumper cable to the negative terminal of the battery, or to the corresponding engine or body ground of assisting vehicle.
5. Attach the second terminal clamp to the negative terminal of the battery, or to the

corresponding engine or body ground of the vehicle to be started.

Starting the engine

Never use spray fluids to start the engine.

1. Start the engine of the assisting vehicle and let it run for several minutes at an increased idle speed.
2. Start the engine of the vehicle that is to be started in the usual way.

If the first starting attempt is not successful, wait a few minutes before making another attempt in order to allow the discharged battery to recharge.

3. Let both engines run for several minutes.
4. Disconnect the jumper cables in the reverse order.

Check the battery and recharge if needed.

Tow-starting and towing

Information

! **WARNING**
Due to system limits, individual functions can malfunction during tow-starting/towing with the Intelligent Safety systems activated, e.g. approach control warning with light braking function. There is risk of an accident. Switch all Intelligent Safety systems off prior to tow-starting/towing. ◀

Transporting the vehicle

Information

! **CAUTION**
The vehicle can be damaged when towing the vehicle with a single lifted axle. There is risk of property damage. The vehicle should only be transported on a loading platform. ◀

Tow truck

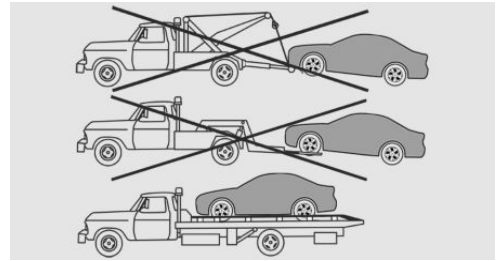

The vehicle should only be transported on a loading platform.

! **CAUTION**
When lifting the vehicle by the tow fitting or body and chassis parts; damage can occur on vehicle parts. There is risk of property damage. Lift vehicle using suitable means. ◀

Towing other vehicles

Information

! **WARNING**
If the approved gross vehicle weight of the towing vehicle is lighter than the vehicle to be towed, the tow fitting can tear off or it will not be possible to control the vehicle's response. There is risk of an accident! Make sure that the gross vehicle weight of the towing vehicle is heavier than the vehicle to be towed. ◀

! **CAUTION**
If the tow bar or tow rope is attached incorrectly, damage to other vehicle parts can occur. There is risk of property damage. Correctly attach the tow bar or tow rope to the tow fitting. ◀

- ▶ Switch on the hazard warning system, depending on local regulations.
- ▶ If the electrical system has failed, clearly identify the vehicle being towed by placing a sign or a warning triangle in the rear window.

Tow bar

The tow fittings used should be on the same side on both vehicles.

Should it prove impossible to avoid mounting the tow bar at an offset angle, please observe the following:

- ▷ Maneuvering capability is limited going around corners.
- ▷ The tow bar will generate lateral forces if it is secured with an offset.

Tow rope

When starting to tow the vehicle, make sure that the tow rope is taut.

To avoid jerking and the associated stresses on the vehicle components when towing, always use nylon ropes or nylon straps.

Tow fitting

General information

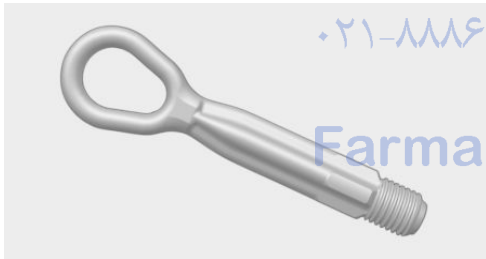

The screw-in tow fitting should always be carried in the vehicle.

The tow fitting can be screwed in at the front or rear of the BMW.

The tow fitting and the onboard vehicle tool kit, refer to page 230, are together in the cargo area.

Information



CAUTION

If the tow fitting is not used as intended, there can be damage to the vehicle or to the tow fitting. There is risk of property damage. Observe the notes on using the tow fitting. ◀

Use of the tow fitting:

- ▷ Use only the tow fitting provided with the vehicle and screw it all the way in.
- ▷ Use the tow fitting for towing on paved roads only.
- ▷ Use tow fitting located in the front only for positioning the vehicle.
- ▷ Avoid lateral loading of the tow fitting, e.g., do not lift the vehicle by the tow fitting.

Screw thread for tow fitting



Press on the mark of the cover to push it out.

Tow-starting

Steptronic transmission

Do not tow-start the vehicle.

Tow-starting the engine is not possible due to the transmission.

Have the cause of the starting problems fixed.

Care

Vehicle features and options

This chapter describes all standard, country-specific and optional features offered with the series. It also describes features that are not necessarily available in your car, e. g., due to the selected options or country versions. This also applies to safety-related functions and systems. The respectively applicable country provisions must be observed when using the respective features and systems.

Car washes

General information

Regularly remove foreign objects such as leaves in the area below the windshield when the hood is raised.

Wash your vehicle frequently, particularly in winter. Intense soiling and road salt can damage the vehicle.

Steam blaster and high-pressure washer

Information

 **CAUTION**
When cleaning with high-pressure washers, components can be damaged due to the pressure or temperatures being too high. There is risk of property damage. Maintain sufficient distance and do not spray too long continuously. Follow the user's manual for the high-pressure washer. ◀

Distances and temperature

- ▷ Maximum temperature: 140 °F/60 °C.
- ▷ Minimum distance from sensors, cameras, seals: 12 in/30 cm.

- ▷ Minimum distance from glass sunroof: 31.5 inches/80 cm.

Automatic car washes

Information

Note the following:

- ▷ Give preference to cloth car washes or those that use soft brushes in order to avoid paint damage.
- ▷ Make sure that the wheels and tires are not damaged by the transport mechanisms.
- ▷ Fold in the exterior mirrors; otherwise, they may be damaged, depending on the width of the vehicle.
- ▷ Deactivate the rain sensor, refer to page 76, to avoid unintentional wiper activation.
- ▷ In some cases, an unintentional alarm can be triggered by the interior motion sensor of the alarm system. Follow the instructions on avoiding an unintentional alarm, refer to page 47.

 **CAUTION**
Too high guide rails in car washes can damage body parts. There is risk of property damage. Avoid car washes with guide rails higher than 4 in/10 cm. ◀

Different types of tires

 **CAUTION**
The vehicle might be too large for the car wash. There is risk of property damage. Before driving into the car wash, make sure that the vehicle is not too large. ◀

Before driving into a car wash

In order to ensure that the vehicle can roll in a car wash, take the following steps:

1. Drive into the car wash.
2. Engage selector lever position N.
3. Deactivating Automatic Hold, refer to page 72.
4. Release the parking brake.
5. Switch the engine off.

In this way, the ignition remains switched on, and a Check-Control message is displayed.



CAUTION

Selector lever position P is automatically engaged when the ignition is switched off. There is risk of property damage. Do not switch ignition off in car washes. ◀

The vehicle cannot be locked from the outside when in selector lever position N. A signal sounds when an attempt is made to lock the vehicle.

To start the engine:

1. Depress the brake pedal.
2. Press the Start/Stop button.

Pressing the Start/Stop button without stepping on the brake turns the ignition off.

Selector lever position

Selector lever position P is engaged automatically:

- ▷ When the ignition is switched off.
- ▷ After approx. 15 minutes.

Headlights

- ▷ Do not rub dry and do not use abrasive or acidic cleansers.
- ▷ Soak areas that have been dirtied e. g., from insects, with shampoo and wash off with water.

- ▷ Thaw ice with de-icing spray; do not use an ice scraper.

After washing the vehicle

After washing the vehicle, apply the brakes briefly to dry them; otherwise, braking action can be reduced and corrosion of the brake discs can occur.

Completely remove all residues on the windows, to minimize loss of visibility due to smearing and to reduce wiper noises and wiper blade wear.

Vehicle care

Car care products

The manufacturer of your vehicle recommends using car care and cleaning products from BMW.



WARNING

Cleansers can contain substances that are dangerous and harmful to your health. There is risk of injuries. When cleaning the interior, open the doors or windows. Only use products intended for cleaning vehicles. Follow the instructions on the container. ◀

Vehicle paint

Regular care contributes to driving safety and value retention. Environmental influences in areas with elevated air pollution or natural contaminants, such as tree resin or pollen can affect the vehicle's paintwork. Tailor the frequency and extent of your car care to these influences.

Aggressive substances such as spilled fuel, oil, grease or bird droppings, must be removed immediately to prevent the finish from being altered or discolored.

Leather care

Remove dust from the leather often, using a cloth or vacuum cleaner.

Otherwise, particles of dust and road grime chafe in pores and folds, and lead to increased wear and premature degradation of the leather surface.

To guard against discoloration, such as from clothing, provide leather care roughly every two months.

Clean light-colored leather more frequently because soiling on such surfaces is substantially more visible.

Use leather care products; otherwise, dirt and grease will gradually break down the protective layer of the leather surface.

Suitable care products are available from a dealer's service center or another qualified service center or repair shop.

Upholstery material care

Vacuum regularly with a vacuum cleaner.

If upholstery is very dirty, e.g., with beverage stains, use a soft sponge or microfiber cloth with a suitable interior cleaner.

Clean the upholstery down to the seams using large sweeping motions. Avoid rubbing the material vigorously.



CAUTION

Open Velcro® fasteners on articles of clothing can damage the seat covers. There is risk of property damage. Ensure that any Velcro® fasteners are closed. ◀

Caring for special components

Light-alloy wheels

When cleaning the vehicle, use only neutral wheel cleaners having a pH value from 5 to 9. Do not use abrasive cleaning agents or steam jets above 140 °F/60 °C. Follow the manufacturer's instructions.

Aggressive, acidic or alkaline cleaning agents can destroy the protective layer of adjacent components, such as the brake disk.

Chrome surfaces

Carefully clean components such as the radiator grille or door handles with an ample supply of water, possibly with shampoo added, particularly when they have been exposed to road salt.

Rubber components

Environmental influences can cause surface soiling of rubber parts and a loss of gloss. For cleaning, use only water and suitable care products, the manufacturer of your vehicle recommends original BMW care products.

Treat especially worn rubber parts with rubber care agents at regular intervals. When cleaning rubber seals, do not use any silicon-containing car care products in order to avoid damage or noises.

Fine wood parts

Clean fine wood facing and fine wood components only with a moist rag. Then dry with a soft cloth.

Plastic components

These include:

- ▷ Imitation leather surfaces.
- ▷ Roofliner.
- ▷ Lamp lenses.
- ▷ Instrument cluster cover.
- ▷ Matt black spray-coated components.
- ▷ Painted parts in the interior.

Clean with a microfiber cloth.

Dampen cloth lightly with water.

Do not soak the roofliner.



CAUTION

Cleaners that contain alcohol or solvents, such as lacquer thinners, heavy-duty grease removers, fuel, or such, can damage plastic parts. There is risk of property damage. Clean with a microfiber cloth. Dampen cloth lightly with water. ◀

Safety belts

Dirty belt straps impede the reeling action and thus have a negative impact on safety.

WARNING

Chemical cleansers can destroy the safety belt webbing. Missing protective effect of the safety belts. There is risk of injuries or danger to life. Use only a mild soapy solution for cleaning the safety belts. ◀

Use only a mild soapy solution, with the safety belts clipped into their buckles.

Do not allow the switches to retract the safety belts until they are dry.

Carpets and floor mats

WARNING

Objects in the driver's floor area can limit the pedal distance or block a depressed pedal. There is risk of an accident. Stow objects in the vehicle such that they are secured and cannot enter into the driver's floor area. Use floor mats that are suitable for the vehicle and can be safely attached to the floor. Do not use loose floor mats and do not layer several floor mats. Make sure that there is sufficient clearance for the pedals. Ensure that the floor mats are securely fastened again after they were removed, e.g. for cleaning. ◀

Floor mats can be removed from the car's interior for cleaning.

If the floor carpets are very dirty, clean with a microfiber cloth and water or a textile cleaner. To prevent matting of the carpet, rub back and forth in the direction of travel only.

Sensor/camera lenses

To clean sensors and camera lenses, use a cloth moistened with a small amount of glass detergent.

Displays/Screens/protective glass of the Head-up Display

CAUTION

Chemical cleansers, moisture or fluids of any kind can damage the surface of displays and screens. There is risk of property damage. Clean with a clean, antistatic microfiber cloth. ◀

CAUTION

The surface of displays can be damaged with improper cleaning. There is risk of property damage. Avoid pressure that is too high and do not use any scratching materials. ◀

Clean with a clean, antistatic microfiber cloth.

Clean the protective glass of the Head-up Display using a microfiber cloth and commercially available dish-washing soap.

Long-term

When the vehicle is shut down for longer than three months, special measures must be taken. Further information is available from a dealer's service center or another qualified service center or repair shop.

امداد خودرو فارما

تلفن شبانه روزی: ۰۲۱-۸۸۸۶۲۰۸۵

FarmaSOS.com



امداد خودرو فارما

تلفن شبانه روزی: ۰۲۱-۸۸۸۶۲۰۸۵

FarmaSOS.com

Reference

This chapter contains the technical data and an index that will quickly take you to the information you need.

امداد خودرو فارما

تلفن شبانه روزی: ۰۲۱-۸۸۸۶۲۰۸۵

FarmaSOS.com

Technical data

Vehicle features and options

This chapter describes all standard, country-specific and optional features offered with the series. It also describes features that are not necessarily available in your car, e. g., due to

the selected options or country versions. This also applies to safety-related functions and systems. The respectively applicable country provisions must be observed when using the respective features and systems.

Information

The technical data and specifications in this Owner's Manual are used as guidance values. The vehicle-specific data can deviate from this, for example, due to the selected special equipment, country version or country-specific measurement method. Detailed values can be

found in the approval documents, on labels on the vehicle or can be obtained from a dealer's service center or another qualified service center or repair shop.

The information in the vehicle documents always has priority.

Dimensions

The dimensions can vary depending on the model version, equipment or country-specific measurement method.

roof racks or spoiler. The heights can deviate, for example, due to the selected special equipment, tires, load and chassis version.

The specified heights do not take into account attached parts, for example, a roof antenna,

BMW X6

Width with mirrors	inches/mm	85.5/2,170
Width without mirrors	inches/mm	78.4/1,989
Height	inches/mm	67.1/1,702
Length	inches/mm	193.9/4,923
Wheelbase	inches/mm	115.5/2,933
Smallest turning radius diam.	ft/m	42/12.8

Weights

X6 sDrive35i		
Approved gross vehicle weight	lbs/kg	6,009/2,726
Load	lbs/kg	1,108/503
Approved front axle load	lbs/kg	2,729/1,238
Approved rear axle load	lbs/kg	3,379/1,533
Approved roof load capacity	lbs/kg	220/100
Cargo area capacity	cu ft	26.6-59.7
Canada: trunk capacity	cu ft/liters	19.4-53.8/550-1,525
X6 xDrive35i		
Approved gross vehicle weight	lbs/kg	6,100/2,767
Load	lbs/kg	1,108/503
Approved front axle load	lbs/kg	2,830/1,284
Approved rear axle load	lbs/kg	3,390/1,538
Approved roof load capacity	lbs/kg	220/100
Cargo area capacity	cu ft	26.6-59.7
Canada: trunk capacity	cu ft/liters	19.4-53.8/550-1,525
X6 xDrive50i		
Approved gross vehicle weight	lbs/kg	6,399/2,903
Load	lbs/kg	1,108/503
Approved front axle load	lbs/kg	3,020/1,370
Approved rear axle load	lbs/kg	3,509/1,592
Approved roof load capacity	lbs/kg	220/100
Cargo area capacity	cu ft	26.6-59.7
Canada: trunk capacity	cu ft/liters	19.4-53.8/550-1,525

Capacities

	US gal/liters	Notes
Fuel tank, approx.	22.4/85	Fuel quality, refer to page 206

امداد خودرو فارما

تلفن شبانه روزی: ۰۲۱-۸۸۸۶۲۰۸۵

FarmaSOS.com

Appendix

Any updates to the Owner's Manual of the vehicle are listed here.

امداد خودرو فارما

تلفن شبانه روزی: ۰۲۱-۸۸۸۶۲۰۸۵

FarmaSOS.com

Everything from A to Z

Index

A

- ABS, Antilock Brake System **134**
- ACC, Active Cruise Control with Stop & Go **142**
- Acceleration Assistant, refer to Launch Control **81**
- Accessories and parts **7**
- Activated-charcoal filter **167**
- Active Blind Spot Detection **130**
- Active Cruise Control with Stop & Go, ACC **142**
- Active Protection **132**
- Active roll stabilization **138**
- Active seat ventilation, front **54**
- Active Steering **138**
- Adaptive brake assistant **134**
- Adaptive brake lights, see Brake force display **132**
- Adaptive Light Control **103**
- Additives, oil **224**
- Adjustments, seats/head restraints **52**
- After washing vehicle **244**
- Airbags **106**
- Airbags, indicator/warning light **107**
- Air circulation, refer to Recirculated-air mode **166**
- Air, dehumidifying, see Cooling function **165**
- Air distribution, manual **166**
- Air flow, automatic climate control **166**
- Air outlets, see ventilation **167**
- Air pressure, tires **208**
- Alarm system **46**
- Alarm, unintentional **47**
- All around the center console **16**
- All around the roofliner **17**
- All around the steering wheel **14**
- All-season tires, see Winter tires **214**
- All-wheel-drive **136**
- Alternating-code hand-held transmitter **172**
- Alternative oil types **224**
- Ambient light **105**
- Animal detection, see Night Vision **124**
- Antifreeze, washer fluid **77**
- Antilock Brake System, ABS **134**
- Anti-slip control, see DSC **135**
- Approved axle load **251**
- Arrival time **96**
- Ashtray **173**
- Ashtray, front **173**
- Ashtray, rear **174**
- Assistance when driving off **134**
- Assist system, see Intelligent Safety **115**
- Attentiveness assistant **132**
- AUTO H button **72**
- AUTO H button, refer to Automatic Hold **72**
- AUTO intensity **166**
- Automatic car wash **243**
- Automatic climate control **164**
- Automatic Cruise Control with Stop & Go **142**
- Automatic Curb Monitor **59**
- Automatic deactivation, Front-seat passenger airbags **108**
- Automatic headlight control **102**
- Automatic Hold **72**
- Automatic locking **46**
- Automatic recirculated-air control **166**
- Automatic Soft Closing, doors **40**
- Automatic tailgate **41**
- Automatic transmission, see Steptronic transmission **78**
- AUTO program, automatic climate control **165**
- AUTO program, intensity **166**
- Auto Start/Stop function **69**
- Average fuel consumption **95**
- Average speed **95**
- Axle loads, weights **251**

B

- Backrest curvature, see Lumbar support **53**
- Backrest, seats **52**
- Backrest, width **54**
- Bad road trips **190**
- Band-aids, see First-aid kit **239**
- Bar for tow-starting/towing **241**
- Battery replacement, vehicle battery **236**
- Battery replacement, vehicle remote control **35**
- Battery, vehicle **236**
- Belts, safety belts **55**
- Beverage holder, cupholder **183**

- Blinds, sun protection [49](#)
- BMW Assist, see user's manual for Navigation, Entertainment and Communication
- BMW Driver's Guide App [6](#)
- BMW Homepage [6](#)
- BMW Internet page [6](#)
- BMW maintenance system [228](#)
- Bonus range, ECO PRO [197](#)
- Bottle holder, see Cupholder [183](#)
- Brake assistant [134](#)
- Brake assistant, adaptive [134](#)
- Brake discs, break-in [188](#)
- Brake force display [132](#)
- Brake lights, adaptive [132](#)
- Brake lights, brake force display [132](#)
- Brake pads, break-in [188](#)
- Braking, hints [189](#)
- Breakdown assistance [238](#)
- Break-in [188](#)
- Brightness of Control Display [98](#)
- Bulb replacement [231](#)
- Bulb replacement, front [232](#)
- Bulb replacement, rear [234](#)
- Bulbs and lights [231](#)
- Button, RES [145](#)
- Button, Start/Stop [67](#)
- Bypassing, see Jump-starting [239](#)
- C**
- California Proposition 65 Warning [8](#)
- Calling up mirror adjustment [46](#)
- Calling up seat adjustment [46](#)
- Calling up steering wheel adjustment [46](#)
- Camera lenses, care [246](#)
- Camera, rearview camera [154](#)
- Camera, Side View [158](#)
- Camera, Top View [157](#)
- Can holder, see Cupholder [183](#)
- Car battery [236](#)
- Car care products [244](#)
- Care, displays [246](#)
- Care, vehicle [244](#)
- Cargo [192](#)
- Cargo area [178](#)
- Cargo area, enlarging [178](#)
- Cargo area, storage compartments [184](#)
- Cargo cover [178](#)
- Cargo, securing [193](#)
- Cargo straps, securing cargo [193](#)
- Car key, see Remote control [34](#)
- Carpet, care [246](#)
- Car wash [243](#)
- Catalytic converter, see Hot exhaust system [189](#)
- CBS Condition Based Service [228](#)
- CD/Multimedia, see user's manual for Navigation, Entertainment and Communication
- Center armrest [181](#)
- Center console [16](#)
- Central locking system [40](#)
- Central screen, see Control Display [18](#)
- Changes, technical, see Own Safety [7](#)
- Changing parts [230](#)
- Changing wheels [234](#)
- Changing wheels/tires [213](#)
- Chassis number, see vehicle identification number [10](#)
- Check Control [86](#)
- Checking the engine oil level electronically [222](#)
- Checking the oil level electronically [222](#)
- Children, seating position [62](#)
- Children, transporting safely [62](#)
- Child restraint fixing system [62](#)
- Child restraint fixing system LATCH [64](#)
- Child restraint fixing systems, mounting [63](#)
- Child safety locks [65](#)
- Child seat, mounting [63](#)
- Child seats [62](#)
- Chrome parts, care [245](#)
- Cigarette lighter [174](#)
- Cleaning displays [246](#)
- Climate control [164](#)
- Climate control windshield [189](#)
- Clock [91](#)
- Closing/opening via door lock [39](#)
- Closing/opening with remote control [37](#)
- Closing the tailgate with no-touch activation [44](#)
- Clothes hooks [184](#)
- Coasting [199](#)
- Coasting with engine decoupled, coasting [199](#)
- Coasting with idling engine [199](#)
- Cockpit [14](#)
- Combination switch, refer to Wiper system [75](#)
- Combination switch, see Turn signals [74](#)
- Comfort Access [42](#)
- COMFORT program, Driving Dynamics Control [140](#)
- Compact wheel, see Emergency wheel [234](#)
- Compartments in the doors [181](#)
- Compass [96](#)

Compressor 215
Condensation on windows 167
Condensation under the vehicle 190
Condition Based Service CBS 228
Confirmation signal 45
ConnectedDrive, see user's manual for Navigation, Entertainment and Communication
ConnectedDrive Services
Connecting electrical devices 175
Continued driving with a flat tire 111, 114
Control Display 18
Control Display, settings 97
Controller 19
Control systems, driving stability 134
Convenient opening with the remote control 38
Coolant 226
Coolant level 226
Coolant temperature 90
Cooler 176
Cooling function 165
Cooling, maximum 165
Cooling system 226
Cornering light 103
Corrosion on brake discs 190
Cosmetic mirror 173
Courtesy lamps during unlocking 37
Courtesy lamps with the vehicle locked 38
Cruise control 148
Cruise control, active with Stop & Go 142
Cruise Control, refer to Active Cruise Control 142
Cruising range 91
Cupholder 183
Current fuel consumption 91

D

Damage, tires 213
Data, technical 250
Date 91
Daytime running lights 103
Defrosting, see Windows, defrosting 167
Dehumidifying, air 165
Deleting personal data 24
Deletion of personal data 24
Departure time, parked-car ventilation 170
Destination distance 96
Digital clock 91
Dimensions 250
Dimmable exterior mirrors 60
Dimmable interior rearview mirror 60
Direction indicator, see Turn signals 74
Display, electronic, instrument cluster 82
Display in windshield 98
Display lighting, see Instrument lighting 105
Displays 83
Displays, cleaning 246
Disposal, coolant 227
Disposal, vehicle battery 237
Distance control, see PDC 151
Distance to destination 96
Divided screen view, split screen 23
Door lock 39
Door lock, see Remote control 34
Doors, Automatic Soft Closing 40
Downhill control 137
DPC, see Dynamic Performance Control 134
Drive mode 139
Drive-off assistant 134

Drive-off assistant, see DSC 135
Driving Dynamics Control 139
Driving instructions, break-in 188
Driving notes, general 188
Driving on bad roads 190
Driving stability control systems 134
Driving tips 188
DSC Dynamic Stability Control 135
DTC Dynamic Traction Control 136
Dynamic Performance Control DPC 134
Dynamic Stability Control DSC 135
Dynamic Traction Control DTC 136

E

ECO PRO 196
ECO PRO, bonus range 197
ECO PRO display 196
ECO PRO displays 84
ECO PRO driving mode 196
ECO PRO mode 196
ECO PRO Tip - driving instruction 198
EfficientDynamics 198
Electronic displays, instrument cluster 82
Electronic oil measurement 222
Electronic Stability Program ESP, see DSC 135
Emergency detection, remote control 35
Emergency release, fuel filler flap 204
Emergency release, parking brake 73
Emergency Request 238

Emergency start function, engine start **35**
 Emergency unlocking, transmission lock **80**
 Emergency wheel **234**
 Energy Control **91**
 Energy recovery **92**
 Engine, automatic Start/Stop function **69**
 Engine, automatic switch-off **69**
 Engine compartment **219**
 Engine compartment, working in **220**
 Engine coolant **226**
 Engine idling when driving, coasting **199**
 Engine oil **222**
 Engine oil, adding **223**
 Engine oil additives **224**
 Engine oil change **224**
 Engine oil filler neck **223**
 Engine oil temperature **90**
 Engine oil types, alternative **224**
 Engine oil types, suitable **224**
 Engine start during malfunction **35**
 Engine start, jump-starting **239**
 Engine start, refer to Starting the engine **68**
 Engine stop **68**
 Engine temperature **90**
 Entering a car wash **243**
 Equipment, interior **171**
 Error displays, see Check Control **86**
 ESP Electronic Stability Program, see DSC **135**
 Exchanging wheels/tires **213**
 Exhaust system **189**
 Exterior mirror, automatic dimming feature **60**
 Exterior mirrors **59**
 External start **239**

External temperature display **90**
 External temperature warning **90**
 Eyes for securing cargo **193**

F

Failure message, see Check Control **86**
 False alarm, see Unintentional alarm **47**
 Fan, see Air flow **166**
 Filler neck for engine oil **223**
 Fine wood, care **245**
 First-aid kit **239**
 Fitting for towing, see Tow fitting **242**
 Flat tire, changing wheels **234**
 Flat Tire Monitor FTM **113**
 Flat tire, Tire Pressure Monitor TPM **109**
 Flat tire, warning lamp **110, 114**
 Flooding **189**
 Floor carpet, care **246**
 Floor mats, care **246**
 Folding back rear seat backrests **178**
 Fold-out position, wiper **77**
 Foot brake **189**
 Front airbags **106**
 Front center armrest **181**
 Front cupholder **183**
 Front-end collision warning with braking function **119**
 Front-end collision warning with City Braking function **116**
 Front fog lamps, , LED, bulb replacement **234**
 Front fog lights **104**
 Front fog lights/cornering lights, bulb replacement **233**

Front lights **232**
 Front-seat passenger airbags, automatic deactivation **108**
 Front-seat passenger airbags, indicator lamp **108**
 Front seats **52**
 FTM Flat Tire Monitor **113**
 Fuel **206**
 Fuel consumption, see Average fuel consumption **95**
 Fuel filler flap **204**
 Fuel gauge **90**
 Fuel lid **204**
 Fuel quality **206**
 Fuel recommendation **206**
 Fuel, tank capacity **252**
 Fuse **237**

G

Garage door opener, see Universal Integrated Remote Control **171**
 Gasoline **206**
 Gear change, Steptronic transmission **78**
 Gear shift indicator **93**
 General driving notes **188**
 Glare shield **173**
 Glasses compartment **182**
 Glass sunroof, powered **49**
 Glove compartment **180**
 Gross vehicle weight, approved **251**

H

Handbrake, see Parking brake **71**
 Hand-held transmitter, alternating code **172**
 Hazard warning flashers **238**
 HDC Hill Descent Control **137**
 Head airbags **106**

Headlight control, automatic **102**

Headlight courtesy delay feature **102**

Headlight flasher **75**

Headlight glass **232**

Headlights **232**

Headlights, care **244**

Head restraints **52**

Head restraints, front **57**

Head-up Display **98**

Head-up Display, care **246**

Heavy cargo, stowing **193**

High-beam Assistant **103**

High beams **75**

High beams/low beams, see High-beam Assistant **103**

Hill Descent Control

HDC **137**

Hills **190**

Hill start assistant, see Drive-off assistant **134**

Holder for beverages **183**

Homepage **6**

Hood **220**

Horn **14**

Hot exhaust system **189**

HUD Head-up Display **98**

Hydroplaning **189**

I

Ice warning, see External temperature warning **90**

Icy roads, see External temperature warning **90**

Identification marks, tires **211**

Identification number, see vehicle identification number **10**

iDrive **18**

Ignition key, see Remote control **34**

Ignition off **67**

Ignition on **67**

Indication of a flat tire **110, 114**

Indicator and alarm lamps, see Check Control **86**

Indicator lamp, see Check Control **86**

Individual air distribution **166**

Individual settings, see Personal Profile **35**

Inflation pressure, tires **208**

Inflation pressure warning

FTM, tires **113**

Info display, refer to On-Board computer **95**

Information **6**

Initialize, Tire Pressure Monitor TPM **110**

Initializing, Flat Tire Monitor FTM **113**

Instrument cluster **82**

Instrument cluster, electronic displays **82**

Instrument display, multifunctional **83**

Instrument lighting **105** من شبانه روزی

Integrated key **34**

Integrated Owner's Manual in the vehicle **29**

Intelligent Emergency Request **238**

Intelligent Safety **115**

Intensity, AUTO program **166**

Interior equipment **171**

Interior lights **105**

Interior lights during unlocking **37**

Interior lights with the vehicle locked **38**

Interior motion sensor **47**

Interior rearview mirror, automatic dimming feature **60**

Internet page **6**

Interval display, service requirements **92**

Interval mode **76**

J

Jacking points for the vehicle jack **234**

Joystick, Steptronic transmission **78**

Jump-starting **239**

K

Key/remote control **34**

Keyless Go, see Comfort Access **42**

Key Memory, see Personal Profile **35**

Kickdown, Steptronic transmission **78**

Knee airbag **107**

L

Label on recommended tires **213**

Lamp in the exterior mirror, see Active Blind Spot Detection **130**

Lamp replacement **231**

Lamp replacement, front **232**

Lamp replacement, rear **234**

Lane departure warning **128**

Lane margin, warning **128**

Language on Control Display **98**

Lashing eyes, securing cargo **193**

LATCH child restraint system **64**

Launch Control **81**

Leather, care **244**

LED headlights, bulb replacement **232**

LEDs, light-emitting diodes **231**

Letters and numbers, entering **25**

Light **101**

Light alloy wheels, care [245](#)
 Light control [103](#)
 Light-emitting diodes, LEDs [231](#)
 Lighting [101](#)
 Lights and bulbs [231](#)
 Light switch [101](#)
 Load [193](#)
 Loading [192](#)
 Lock, door [39](#)
 Locking/unlocking via door lock [39](#)
 Locking/unlocking with remote control [37](#)
 Locking, automatic [46](#)
 Locking, settings [45](#)
 Lock, power window [49](#)
 Locks, doors, and windows [65](#)
 Low beams [101](#)
 Low beams, automatic, see High-beam Assistant [103](#)
 Lower back support [53](#)
 Luggage rack, see Roof-mounted luggage rack [194](#)
 Lumbar support [53](#)

M

Maintenance [228](#)
 Maintenance requirements [228](#)
 Maintenance, service requirements [92](#)
 Maintenance system, BMW [228](#)
 Make-up mirror [173](#)
 Malfunction displays, see Check Control [86](#)
 Malfunction, self-leveling suspension [139](#)
 Manual air distribution [166](#)
 Manual air flow [166](#)
 Manual brake, see Parking brake [71](#)
 Manual mode, Steptronic transmission [79](#)
 Manual operation, door lock [39](#)
 Manual operation, exterior mirrors [59](#)
 Manual operation, fuel filler flap [204](#)
 Manual operation, Park Distance Control PDC [152](#)
 Manual operation, parking brake [73](#)
 Manual operation, rearview camera [154](#)
 Manual operation, Top View [157](#)
 Marking, run-flat tires [214](#)
 Master key, see Remote control [34](#)
 Maximum cooling [165](#)
 Maximum speed, display [93](#)
 Maximum speed, winter tires [214](#)
 Measurement, units of [98](#)
 Medical kit [239](#) تلفن شبانه روزی: ۵
 Memory for seat, mirrors, steering wheel [58](#)
 Menu, EfficientDynamics [198](#)
 Menu in instrument cluster [94](#)
 Menus, operating, iDrive [18](#)
 Menus, refer to iDrive operating concept [20](#)
 Messages, see Check Control [86](#)
 Microfilter [167](#)
 Minimum tread, tires [212](#)
 Mirror [59](#)
 Mirror memory [58](#)
 Mobile communication devices in the vehicle [189](#)
 Mobility System [215](#)
 Modifications, technical, see Own Safety [7](#)
 Moisture in headlight [232](#)

Monitor, see Control Display [18](#)
 Mounting of child restraint systems [63](#)
 Moving sun visor [173](#)
 Multifunctional instrument display [83](#)
 Multifunction steering wheel, buttons [14](#)

N

Navigation, see user's manual for Navigation, Entertainment and Communication
 Neck restraints, front, see Head restraints [57](#)
 Neutral cleaner, see wheel cleaner [245](#)
 New wheels and tires [213](#)
 Night Vision [124](#)
 Night Vision device, see Night Vision [124](#)
 Nylon rope for tow-starting/towing [241](#)

O

OBD Onboard Diagnosis [229](#)
 OBD, see OBD Onboard Diagnosis [229](#)
 Object detection, see Night Vision [124](#)
 Obstacle marking, rearview camera [155](#)
 Octane rating, see Recommended fuel grade [206](#)
 Odometer [90](#)
 Office, see user's manual for Navigation, Entertainment and Communication
 Offroad trips [190](#)
 Oil [222](#)
 Oil, adding [223](#)
 Oil additives [224](#)
 Oil change [224](#)

- Oil change interval, service requirements [92](#)
- Oil filler neck [223](#)
- Oil types, alternative [224](#)
- Oil types, suitable [224](#)
- Old batteries, disposal [237](#)
- On-board computer [95](#)
- On-board computer, refer to On-board computer [95](#)
- Onboard monitor, see Control Display [18](#)
- Onboard vehicle tool kit [230](#)
- Opening/closing via door lock [39](#)
- Opening and closing [34](#)
- Opening and closing, without remote control [39](#)
- Opening and closing, with remote control [37](#)
- Opening the tailgate with no-touch activation [44](#)
- Operating concept, iDrive [18](#)
- Optional equipment, standard equipment [7](#)
- Outside air, refer to Automatic recirculated-air control [166](#)
- Overheating of engine, see Coolant temperature [90](#)
- Own Safety [7](#)
- P**
- Paint, vehicle [244](#)
- Parallel parking assistant [160](#)
- Park Distance Control
PDC [151](#)
- Parked-car ventilation [169](#)
- Parked vehicle, condensation [190](#)
- Parking aid, see PDC [151](#)
- Parking assistant [160](#)
- Parking brake [71](#)
- Parking lights [101](#)
- Parking with Automatic Hold [72](#)
- Parts and accessories [7](#)
- Passenger side mirror, tilting downward [59](#)
- Pathway lines, rearview camera [155](#)
- PDC Park Distance Control [151](#)
- Pedestrian detection, see Night Vision [124](#)
- Pedestrian warning with city braking function [122](#)
- Personal Profile [35](#)
- Personal Profile, exporting profiles [36](#)
- Pinch protection system, glass sunroof [51](#)
- Pinch protection system, windows [48](#)
- Plastic, care [245](#)
- Power failure [236](#)
- Power sunroof, glass [49](#)
- Power windows [48](#)
- Prescribed engine oil types [224](#)
- Pressure, tire air pressure - شیشه روزی [208](#)
- Pressure warning FTM, tires [113](#)
- Profile, see Personal Profile [35](#)
- Programmable memory buttons, iDrive [24](#)
- Protective function, glass sunroof [51](#)
- Protective function, windows [48](#)
- Push-and-turn switch, see Controller [19](#)
- R**
- Radiator fluid [226](#)
- Radio-operated key, see Remote control [34](#)
- Radio ready state [67](#)
- Radio, see user's manual for Navigation, Entertainment and Communication
- Rain sensor [76](#)
- Rear automatic climate control [168](#)
- Rear center armrest [182](#)
- Rear cooler [176](#)
- Rear drink holder [183](#)
- Rear lights [234](#)
- Rear seats [55](#)
- Rearview camera [153](#)
- Rearview mirror [59](#)
- Rear window defroster [167](#)
- Recirculated-air mode [166](#)
- Recommended fuel grade [206](#)
- Recommended tire brands [213](#)
- Refueling [204](#)
- Remaining range [91](#)
- Remote control/key [34](#)
- Remote control, malfunction [39](#)
- Remote control, universal [171](#)
- Replacement fuse [237](#)
- Replacing parts [230](#)
- Replacing wheels/tires [213](#)
- Reporting safety malfunctions [10](#)
- RES button [145](#)
- RES button, see Active Cruise Control, ACC [142](#)
- RES button, see Cruise control [148](#)
- Reserve warning, see Range [91](#)
- Reset, Tire Pressure Monitor TPM [110](#)
- Residual heat, automatic climate control [166](#)
- Retaining straps, securing cargo [193](#)
- Retreaded tires [214](#)
- Roadside parking lights [102](#)

Roller sunblinds [49](#)
 RON recommended fuel grade [206](#)
 Roofliner [17](#)
 Roof load capacity [251](#)
 Roof-mounted luggage rack [194](#)
 Rope for tow-starting/towing [241](#)
 RSC Run Flat System Component, see Run-flat tires [214](#)
 Rubber components, care [245](#)
 Run-flat tires [214](#)

S

Safe braking [189](#)
 Safety belt reminder for driver's seat and front passenger seat [56](#)
 Safety belts [55](#)
 Safety belts, care [246](#)
 Safety Package, see Active Protection [132](#)
 Safety switch, windows [49](#)
 Safety systems, airbags [106](#)
 Saving fuel [195](#)
 Screen, see Control Display [18](#)
 Screwdriver, see Onboard vehicle tool kit [230](#)
 Screw thread, refer to Screw thread for tow fitting, screw thread for tow fitting [242](#)
 Sealant [215](#)
 Seat belts, see Safety belts [55](#)
 Seat heating, front [54](#)
 Seat heating, rear [55](#)
 Seating position for children [62](#)
 Seat, mirror, and steering wheel memory [58](#)
 Seats [52](#)
 Seats, front [52](#)
 Seats, rear [55](#)
 Seat ventilation, front [54](#)
 Selection list in instrument cluster [94](#)
 Selector lever, Steptronic transmission [78](#)
 Self-leveling suspension, air suspension [138](#)
 Self-leveling suspension, malfunction [139](#)
 Sensors, care [246](#)
 Service and warranty [8](#)
 Service requirements, Condition Based Service CBS [228](#)
 Service requirements, display [92](#)
 Services, ConnectedDrive SET button, see Active Cruise Control, ACC [142](#)
 SET button, see Cruise control [148](#)
 Settings, locking/unlocking [45](#)
 Settings on Control Display [97](#)
 Settings, storing for seat, mirrors, steering wheel [58](#)
 Shift paddles on the steering wheel [80](#)
 Shift point indicator [85](#)
 Shoulder support [54](#)
 Side airbags [106](#)
 Side View [158](#)
 Signaling, horn [14](#)
 Signals when unlocking [45](#)
 Sitting safely [52](#)
 Size [250](#)
 Ski and snowboard bag [179](#)
 Slide/tilt glass roof [49](#)
 Smoker's package [173](#)
 Snow chains [218](#)
 Socket, OBD Onboard Diagnostics [229](#)
 Sockets, see Connecting electrical devices [175](#)
 SOS button [238](#)
 Spare fuse [237](#)
 Spare tire, see Emergency wheel [234](#)
 Speed, average [95](#)
 Speed limit detection, on-board computer [96](#)
 Speed limiter, display [93](#)
 Speed Limit Information [93](#)
 Speed warning [97](#)
 Split screen [23](#)
 SPORT+ - program, Dynamic Driving Control [140](#)
 Sport displays, torque display, performance display [96](#)
 SPORT program, driving dynamics [140](#)
 Sport program, transmission [79](#)
 Stability control systems [134](#)
 Start/stop, automatic function [69](#)
 Start/Stop button [67](#)
 Start function during malfunction [35](#)
 Starting the engine [68](#)
 Status control display, tires [110](#)
 Status information, iDrive [23](#)
 Status of Owner's Manual [7](#)
 Steering, Active Steering [138](#)
 Steering wheel, adjusting [60](#)
 Steering wheel heating [61](#)
 Steering wheel memory [58](#)
 Steptronic Sport transmission, see Steptronic transmission [78](#)
 Steptronic transmission [78](#)
 Stopping the engine [68](#)
 Storage compartment on the center console [181](#)
 Storage compartments [180](#)

- Storage compartments, locations **180**
- Storage, tires **214**
- Storing the vehicle **246**
- Suitable engine oil types **224**
- Summer tires, tread **212**
- Sun visor **173**
- Supplementary text message **89**
- Surround View **153**
- Suspension settings **139**
- Switch for Dynamic Driving Control **139**
- Switch, refer to Cockpit **14**
- Symbols **6**
- Symbols in the status field **23**
- SYNC program, automatic climate control **166**
- ## T
- Tachometer **90**
- Tailgate, automatic **41**
- Tailgate, closing with no-touch activation **44**
- Tailgate, opening with no-touch activation **44**
- Tailgate via remote control **38**
- Tail lights **234**
- Technical changes, see Own Safety **7**
- Technical data **250**
- Telephone, see user's manual for Navigation, Entertainment and Communication
- Temperature, automatic climate control **165**
- Temperature display for external temperature **90**
- Temperature, engine oil **90**
- Terminal, starting aid **240**
- Text message, supplementary **89**
- Theft alarm system, see Alarm system **46**
- Thermal camera, see Night Vision **124**
- Thigh support **53**
- Tilt alarm sensor **47**
- Time of arrival **96**
- Tire damage **213**
- Tire identification marks **211**
- Tire inflation pressure **208**
- Tire inflation pressure monitor, see FTM **113**
- Tire Pressure Monitor TPM **109**
- Tires, changing **213**
- Tire sealant **215**
- Tires, everything on wheels and tires **208**
- Tires, run-flat tires **214**
- Tire tread **212**
- Tone, see user's manual for Navigation, Entertainment and Communication
- Tool **230**
- Top View **156**
- Total vehicle weight **251**
- Touchpad **21**
- Tow fitting **242**
- Towing **241**
- Tow lug, see Tow fitting **242**
- Tow-starting **241**
- TPM Tire Pressure Monitor **109**
- Traction control **136**
- TRACTION, driving dynamics **136**
- TRACTION program, Dynamic Driving Control **140**
- Transmission lock, electronic unlocking **80**
- Transmission, see Steptronic transmission **78**
- Transporting children safely **62**
- Tread, tires **212**
- Triple turn signal activation **74**
- Trip odometer **90**
- Trip on-board computer **96**
- Trip recorder, see Trip odometer **90**
- Turning circle lines, rearview camera **155**
- Turn signals, operation **74**
- ## U
- Unintentional alarm **47**
- Units of measurement **98**
- Universal remote control **171**
- Unlock button, Steptronic transmission **79**
- Unlocking/locking via door lock **39**
- Unlocking/locking with remote control **37**
- Unlocking, settings **45**
- Unpaved roads, cross-country trips **190**
- Updates made after the editorial deadline **7**
- Upholstery care **245**
- USB interface **176**
- ## V
- Vanity mirror **173**
- Variable steering **138**
- Vehicle battery **236**
- Vehicle battery, replacing **236**
- Vehicle, break-in **188**
- Vehicle care **244**
- Vehicle features and options **7**
- Vehicle identification number **10**
- Vehicle jack **234**
- Vehicle paint **244**
- Vehicle storage **246**
- Vehicle wash **243**
- Ventilation **167**
- Ventilation, see Parked-car ventilation **169**

Venting, see ventilation [167](#)
 Vent, see ventilation [167](#)
 Vertical Dynamic Control [138](#)
 VIN, see vehicle identification number [10](#)
 Voice activation system [26](#)

W

Warning and indicator lamps, see Check Control [86](#)
 Warning displays, see Check Control [86](#)
 Warning lamp in the exterior mirror, see Active Blind Spot Detection [130](#)
 Warning messages, see Check Control [86](#)
 Warning triangle [239](#)
 Warranty [7](#)
 Washer fluid [77](#)
 Washer nozzles, windshield [77](#)
 Washer system [75](#)
 Washing, vehicle [243](#)
 Water on roads [189](#)
 Weights [251](#)
 Welcome lamps during unlocking [37](#)
 Welcome lights [102](#)
 Wheel cleaner [245](#)
 Wheels, changing [213](#)
 Wheels, everything on wheels and tires [208](#)
 Wheels, Flat Tire Monitor FTM [113](#)
 Wheels, Tire Pressure Monitor TPM [109](#)
 Window defroster, rear [167](#)
 Windows, powered [48](#)
 Windshield, climate control [189](#)
 Windshield washer fluid [77](#)
 Windshield washer nozzles [77](#)

Windshield washer system [75](#)
 Windshield washer system, see washer/wiper system [75](#)
 Windshield wiper [75](#)
 Winter storage, care [246](#)
 Winter tires, suitable tires [214](#)
 Winter tires, tread [212](#)
 Wiper [75](#)
 Wiper blades, replacing [230](#)
 Wiper fluid [77](#)
 Wiper, fold-out position [77](#)
 Wiper system [75](#)
 Wood, care [245](#)
 Word match concept, navigation [25](#)
 Wrench, see Onboard vehicle tool kit [230](#)

X

xDrive [136](#)
 Xenon headlights, bulb replacement [232](#)

FarmaSOS.com

امداد خودرو فارما

تلفن شبانه روزی: ۰۲۱-۸۸۸۶۲۰۸۵

FarmaSOS.com

More about BMW



The Ultimate
Driving Machine®

bmwusa.com

امداد خودرو فارما

تلفن شبانه روزی: ۰۲۱-۸۸۸۶۲۰۸۵

FarmaSOS.com

01 40 2 963 464 ue

