

# Contents

A-Z

Owner's Manual for  
Vehicle



The Ultimate Driving  
Machine



## THE BMW Z4. OWNER'S MANUAL.

**BMW EfficientDynamics**  
Less emissions. More driving pleasure.

# امداد خودرو فارما

تلفن شبانه روزی: ۰۲۱-۸۸۸۶۲۰۸۵

**FarmaSOS.com**

**Z4 sDrive28i**  
**Z4 sDrive35i**  
**Z4 sDrive35is**

## **Owner's Manual for Vehicle**

Thank you for choosing a BMW.

The more familiar you are with your vehicle, the better control you will have on the road. We therefore strongly suggest:

Read this Owner's Manual before starting off in your new BMW. It contains important information on vehicle operation that will help you make full use of the technical features available in your BMW. The manual also contains information designed to enhance operating reliability and road safety, and to contribute to maintaining the value of your BMW.

Supplementary information can be found in the additional brochures in the onboard literature.

We wish you a safe and enjoyable drive.

BMW AG

امداد خودرو فارما

تلفن شبانه روزی: ۰۲۱-۸۸۸۶۲۰۸۵

**FarmaSOS.com**

BMW recommends 

# امداد خودرو فارما

تلفن شبانه روزی: ۰۲۱-۸۸۸۶۲۰۸۵

[FarmaSOS.com](http://FarmaSOS.com)

© 2011 Bayerische Motoren Werke  
Aktiengesellschaft

Munich, Germany

Reprinting, including excerpts, only with the written  
consent of BMW AG, Munich.

US English VIII/11, 09 11 500

Printed on environmentally friendly paper, bleached  
without chlorine, suitable for recycling.



# Contents

The fastest way to find information on a particular topic or item is by using the index, refer to page 208.

6 Notes

## At a glance

12 Cockpit

## Controls

20 Opening and closing

36 Adjusting

43 Transporting children safely

45 Driving

60 Displays

68 Lamps

73 Safety

81 Driving stability control systems

85 Driving comfort

89 Climate

96 Interior equipment

103 Storage compartments

## Driving tips

108 Things to remember when driving

## Entertainment

116 Professional Radio

## Communication

134 Telephone

145 ConnectedDrive

## Mobility

152 Refueling

154 Fuel

155 Wheels and tires

163 Engine compartment

168 Maintenance

170 Replacing components

176 Breakdown assistance

182 Care

186 Indicator/warning lamps

## Reference

202 Technical data

208 Everything from A to Z

امداد خودرو فارما

تلفن شبانه روزی: ۰۲۱-۸۸۸۶۲۰۸۵

FarmaSOS.com

# Notes

## Using this Owner's Manual

The fastest way to find information on a particular topic is by using the index.

An initial overview of the vehicle is provided in the first chapter.

### Additional sources of information

Should you have any questions, your service center will be glad to advise you at any time.

Information on BMW, e.g., on technology, is available on the Internet: [bmwusa.com](http://bmwusa.com)

## Symbols

 Indicates precautions that must be followed precisely in order to avoid the possibility of personal injury and serious damage to the vehicle.

◀ Marks the end of a specific item of information.

"..." Identifies radio display texts used to select individual functions.

>...< Verbal instructions to use with the voice activation system.

>>...<< Identifies the answers generated by the voice activation system.

 Refers to measures that can be taken to help protect the environment.

### Symbols on vehicle components

 Indicates that you should consult the relevant section of this Owner's Manual for information on a particular part or assembly.

## Vehicle equipment

This Owner's Manual describes all models, all series equipment, as well as country-specific and special equipment offered in the model series. Therefore, this Owner's Manual also de-

scribes and depicts equipment that may not be contained in your vehicle because of the selected special equipment or country version, for example.

This also applies to safety-related functions and systems.

For options and equipment not described in this Owner's Manual, please refer to the Supplementary Owner's Manuals.

On right-hand drive vehicles, some controls are arranged differently than shown in the illustrations.

## Status of this Owner's Manual at time of printing

The manufacturer of your vehicle pursues a policy of constant development that is conceived to ensure that our vehicles continue to embody the highest quality and safety standards. In rare cases, therefore, the features described in this Owner's Manual may differ from those in your vehicle.

### Updates made after the editorial deadline

Any updates made after the editorial deadline for the Owner's Manuals are located in the appendix of the printed quick reference for the vehicle.

## For your own safety

### Maintenance and repairs

Advanced technology, e.g., the use of modern materials and high-performance electronics, requires suitable maintenance and repair methods.

Therefore, have this work performed only by a BMW center or a workshop that works accord-

ing to BMW repair procedures with appropriately trained personnel.

If this work is not carried out properly, there is the danger of subsequent damage and related safety hazards.

## Parts and accessories

For your own safety, use genuine parts and accessories approved by BMW. When you purchase accessories tested and approved by BMW and Genuine BMW Parts, you simultaneously acquire the assurance that they have been thoroughly tested by BMW to ensure optimum performance when installed on your vehicle. BMW warrants these parts to be free from defects in material and workmanship. BMW will not accept any liability for damage resulting from installation of parts and accessories not approved by BMW. BMW cannot test every product made by other manufacturers to verify if it can be used on a BMW safely and without risk to either the vehicle, its operation, or its occupants. Genuine BMW Parts, BMW Accessories and other products approved by BMW, together with professional advice on using these items, are available from all BMW centers. Installation and operation of non-BMW approved accessories such as alarms, radios, amplifiers, radar detectors, wheels, suspension components, brake dust shields, telephones, including operation of any mobile phone from within the vehicle without using an externally mounted antenna, or transceiver equipment, for instance, CBs, walkie-talkies, ham radios or similar accessories, may cause extensive damage to the vehicle, compromise its safety, interfere with the vehicle's electrical system or affect the validity of the BMW Limited Warranty. See your BMW center for additional information. Maintenance, replacement, or repair of the emission control devices and systems may be performed by any automotive repair establishment or individual using any certified automotive part.

## California Proposition 65 Warning

California laws require us to state the following warning:

Engine exhaust and a wide variety of automobile components and parts, including components found in the interior furnishings in a vehicle, contain or emit chemicals known to the State of California to cause cancer and birth defects and reproductive harm. In addition, certain fluids contained in vehicles and certain products of component wear contain or emit chemicals known to the State of California to cause cancer and birth defects or other reproductive harm. Battery posts, terminals and related accessories contain lead and lead compounds. Wash your hands after handling. Used engine oil contains chemicals that have caused cancer in laboratory animals. Always protect your skin by washing thoroughly with soap and water.

## Service and warranty

We recommend that you read this publication thoroughly. Your vehicle is covered by the following warranties:

- ▷ New Vehicle Limited Warranty
- ▷ Rust Perforation Limited Warranty
- ▷ Federal Emissions System Defect Warranty
- ▷ Federal Emissions Performance Warranty
- ▷ California Emission Control System Limited Warranty

Detailed information about these warranties is listed in the Service and Warranty Information Booklet for US models or in the Warranty and Service Guide Booklet for Canadian models.

Your vehicle has been specifically adapted and designed to meet the particular operating conditions and homologation requirements in your country and continental region in order to deliver the full driving pleasure while the vehicle is operated under those conditions. If you wish to operate your vehicle in another country or region, you may be required to adapt your vehicle to meet different prevailing operating conditions and homologation requirements. You should

also be aware of any applicable warranty limitations or exclusions for such country or region. In such case, please contact Customer Relations for further information.

## Maintenance

Maintain the vehicle regularly to sustain the road safety, operational reliability and the New Vehicle Limited Warranty.

Specifications for required maintenance measures:

- ▷ BMW Maintenance system
- ▷ Service and Warranty Information Booklet for US models
- ▷ Warranty and Service Guide Booklet for Canadian models

If the vehicle is not maintained according to these specifications, this could result in serious damage to the vehicle. Such damage is not covered by the BMW New Vehicle Limited Warranty.

## Reporting safety defects

### For US customers

The following only applies to vehicles owned and operated in the US.

If you believe that your vehicle has a defect which could cause a crash or could cause injury or death, you should immediately inform the National Highway Traffic Safety Administration NHTSA, in addition to notifying BMW of North America, LLC, P.O. Box 1227, Westwood, New Jersey 07675-1227, Telephone 1-800-831-1117.

If NHTSA receives similar complaints, it may open an investigation, and if it finds that a safety defect exists in a group of vehicles, it may order a recall and remedy campaign.

However, NHTSA cannot become involved in individual problems between you, your dealer, or BMW of North America, LLC.

To contact NHTSA, you may call the Vehicle Safety Hotline toll-free at 1-888-327-4236 (TTY: 1-800-424-9153); go to <http://www.safercar.gov>; or write to: Administrator, NHTSA, 400 Seventh Street, SW., Washington, DC 20590. You can also obtain other information about motor vehicle safety from <http://www.safercar.gov>

### For Canadian customers

Canadian customers who wish to report a safety-related defect to Transport Canada, Defect Investigations and Recalls, may telephone the toll-free hotline 1-800-333-0510. You can also obtain other information about motor vehicle safety from <http://www.tc.gc.ca/roadsafety>.

# امداد خودرو فارما

تلفن شبانه روزی: ۰۲۱-۸۸۸۶۲۰۸۵

**FarmaSOS.com**



# امداد خودرو فارما

تلفن شماره روزی: ۰۲۶-۸۸۸۶۲۰۸۵

[FarmaSOS.com](http://FarmaSOS.com)

## At a glance

These overviews of buttons, switches and displays are intended to familiarize you with your vehicle. You will also become quickly acquainted with the available control concepts and options.

امداد خودرو فارما

تلفن شبانه روزی: ۰۲۱-۸۸۸۶۲۰۸۵

FarmaSOS.com



# Cockpit

## Vehicle equipment

This chapter describes all series equipment as well as country-specific and special equipment offered for this model series. Therefore, it also





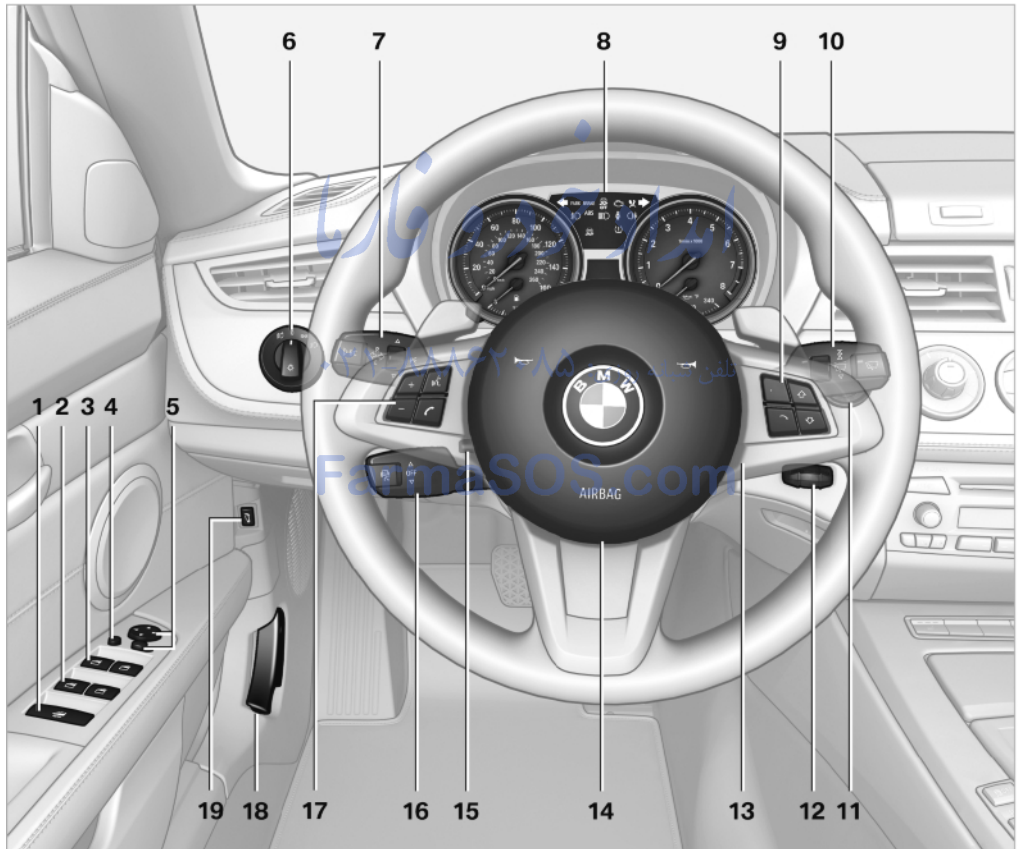



















describes equipment that may not be found in your vehicle, for instance due to the selected special equipment or the country version. This also applies to safety-related functions and systems.

## All around the steering wheel



1  Opening and closing windows jointly [32](#)

2  Opening and closing rear windows [32](#)

- 3  Opening and closing front windows 32
- 4 Exterior mirrors, folding in and out 40
- 5 Adjust the exterior mirrors, Automatic Curb Monitor 40
- 6  Parking lamps 68
-  Low beams 68
-  Automatic headlamp control 69
- Adaptive light control 70
- High-beam Assistant 71
- 7  Turn signal 50
-  High beams, headlamp flasher 70
-  High-beam Assistant 71
-  Roadside parking lamps 70
-  Computer 62
-  Settings and information about the vehicle 62
- 8 Instrument cluster 14
- 9 Buttons on the steering wheel
-  Change the radio station
-  Select a music track
-  Leaf through the phone book and through lists with stored phone numbers
-  Next entertainment source
-  Recirculated air mode 94
- 10  Windshield wipers 51
-  Rain sensor 51
- 11  Start/stop the engine and switch the ignition on/off 45
- 12 Ignition lock 45
- 13  Steering wheel heating 42
- 14 Horn, the entire surface
- 15 Adjust the steering wheel 42
- 16  Cruise control 85
- 17 Buttons on the steering wheel
-  Telephone 134
-  Volume
-  Voice operation of the telephone 141
- 18 Releasing the hood 164
- 19  Open the trunk lid 27

## Instrument cluster



- 1 Speedometer
  - 2 Indicator lamps for turn signals
  - 3 Indicator/warning lamps [15۲۱-۸۸۶۲۰۸۵](#)
  - 4 Tachometer [61](#)
  - 5 Engine oil temperature [61](#)
  - 6 Display for
    - ▷ Clock [60](#)
    - ▷ External temperature [60](#)
    - ▷ Indicator/warning lamps [15](#)
    - ▷ Cruise control [85](#)
  - 7 Display for
    - ▷ Gear display, 8-gear Sport automatic transmission [55](#)
    - ▷ Gear display for 7-gear Sport automatic transmission with dual clutch [55](#)
  - 8 Fuel gauge [61](#)
  - 9 Resetting the trip odometer [60](#)
- ▷ Computer [62](#)
  - ▷ Date of next scheduled service, and remaining distance to be driven [65](#)
  - ▷ Odometer and trip odometer [60](#)
  - ▷ Programs for Dynamic Driving Control [82](#)
  - ▷ High-beam Assistant [71](#)
  - ▷ Initializing the Flat Tire Monitor [75](#)
  - ▷ Resetting Tire Pressure Monitor [78](#)
  - ▷ Checking engine oil level [164](#)
  - ▷ Settings and information [62](#)
  - ▷ **▲** Check Control message present [66](#)

## Indicator/warning lamps

### Instrument cluster



The indicator and warning lamps can light up in a variety of combinations and colors.

Several of the lamps are checked for proper functioning when the engine is started or the ignition is switched on, and light up briefly.

### What to do in case of a malfunction

A list of all indicator and warning lamps, as well as notes on possible causes of malfunctions and on how to respond, refer to page 186.

## All around the center console

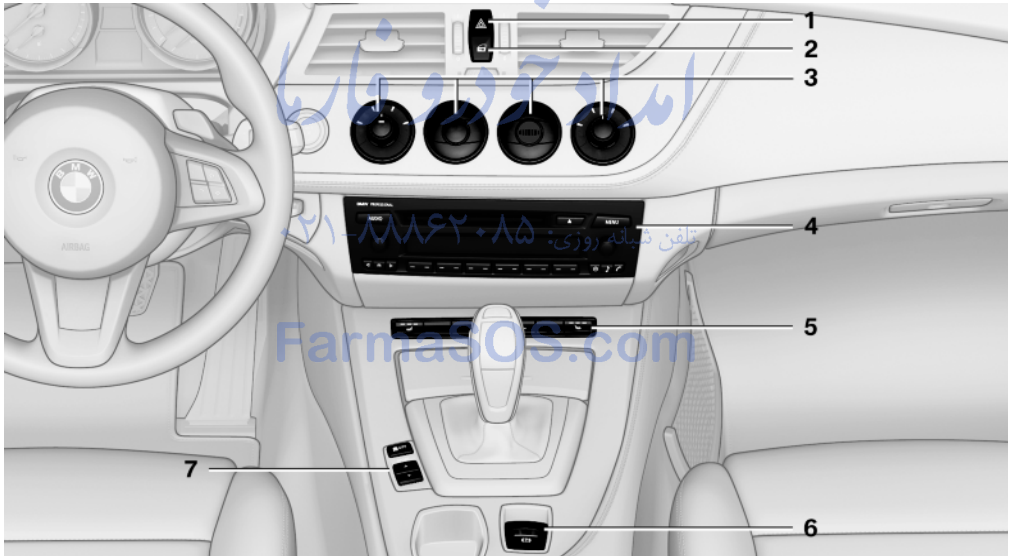

1 Hazard warning system 176

2 Central locking system 26

3 Air conditioner 90

Automatic climate control 92

4 Professional Radio 116

5  Seat heating 38



PDC Park Distance Control 87



Close the retractable hard-top 33



Open the retractable hard-top 33



Deactivate the Automatic Engine Start/Stop Function 47

6 Parking brake 49

7 Buttons for Dynamic Driving Control 82

## All around the headliner

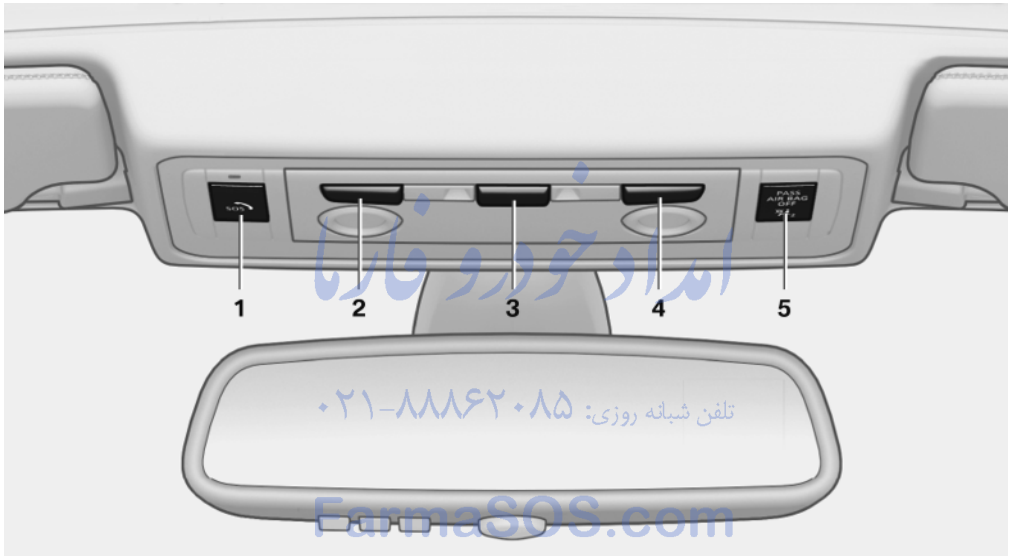

1 Emergency Request 176



2 Reading lamp 72

3 Interior lamps 72

4 Reading lamp 72

5 Indicator lamp, front passenger airbag 74



# امداد خودرو فارما

تلفن شبانه روزی: ۰۲۱-۸۸۸۶۲۰۸۵

**FarmaSOS.com**



START  
STOP  
ENGINE

امداد خودرو فارما

تلفن شبانه روزی: ۰۲۱-۸۸۸۶۲۰۸۵

[FarmaSOS.com](http://FarmaSOS.com)



## Controls

This chapter is intended to provide you with information that will give you complete control of your vehicle. All features and accessories that are useful for driving and your safety, comfort and convenience are described here.

تلفن شبانه روزی: ۰۲۱-۸۸۸۶۲۰۸۵

FarmaSOS.com

# Opening and closing

## Vehicle equipment

This chapter describes all series equipment as well as country-specific and special equipment offered for this model series. Therefore, it also describes equipment that may not be found in your vehicle, for instance due to the selected special equipment or the country version. This also applies to safety-related functions and systems.

## Remote control

### Buttons on the remote control

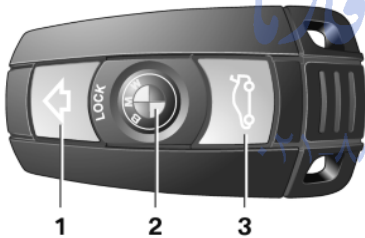

- 1 Unlocking
- 2 Locking
- 3 Opening the trunk lid

### General information

The vehicle is supplied with two remote controls with keys.

Each remote control contains a rechargeable battery that is automatically recharged when it is in the ignition lock while the car is being driven. Use each remote control at least twice a year for longer road trips in order to maintain the batteries' charge status.

In vehicles equipped with Comfort Access, the remote control contains a replaceable battery, refer to page 30.

The settings called up and implemented when the vehicle is unlocked depend on which remote control is used to unlock the vehicle, refer to Personal Profile.

In addition, information about service requirements is stored in the remote control, Service data in the remote control, refer to page 168.

### Integrated key

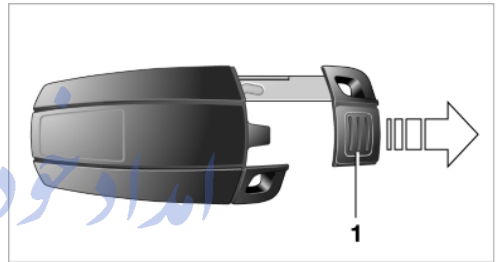

Press button 1 and pull out the key.

The integrated key fits the following locks:

- ▷ Glove compartment, refer to page 103.
- ▷ Driver's door, refer to page 25.

### New remote controls

You can obtain new remote controls from your service center.

### Loss of the remote controls

Lost remote controls can be blocked by your service center.

## Personal Profile

### The concept

You can set several of your vehicle's functions to suit your personal needs and preferences.

- ▷ The settings are automatically saved in the profile currently activated.

- ▷ The remote control used is detected when the vehicle is unlocked and the stored profile is called up.
- ▷ Your personal settings will be recognized and called up again even if the vehicle has been used in the meantime by someone else with another remote control.

The individual settings are stored for a maximum of four remote controls. They are stored for two remote controls if Comfort Access is in use.

### Personal Profile settings

The following functions and settings can be stored in a profile.

More information on the settings can be found under:

- ▷ Response of the central locking system when the car is being unlocked, refer to page 22.
- ▷ Automatic locking of the vehicle, refer to page 26.
- ▷ Automatic retrieval of the driver's seat and exterior mirror positions after unlocking, refer to page 24.
- ▷ Triple turn signal activation, refer to page 50.
- ▷ Settings for the display in the instrument cluster:
  - ▷ 12h/24h clock format, refer to page 63.
  - ▷ Date format, refer to page 63.
  - ▷ Units of measure for fuel consumption, distance covered/remaining distances, and temperature, refer to page 63.
- ▷ Light settings:
  - ▷ Headlamp courtesy delay feature, refer to page 68.
  - ▷ Daytime running lights, refer to page 69.
  - ▷ High-beam Assistant, refer to page 71.

- ▷ Automatic climate control: AUTO program, cooling function, and automatic recirculated air control activated/deactivated, temperature, air flow rate, and air distribution, refer to page 92.
- ▷ Entertainment:
  - ▷ Audio volume, Professional Radio, refer to page 118.

## Central locking system

### The concept

The central locking system becomes active when the driver's door is closed.

The system simultaneously engages and releases the locks on the following:

- ▷ Doors.
- ▷ Trunk lid.
- ▷ Fuel filler flap.
- ▷ Center armrest.

### Operating from the outside

- ▷ Via the remote control.
- ▷ Via the driver's door lock.
- ▷ In cars with Comfort Access, via the door handles on the driver's and front passenger sides.

The following takes place simultaneously when locking/unlocking the vehicle via the remote control:

- ▷ The welcome lamps, interior lamps and courtesy lamps are switched on and off.
- ▷ The alarm system is armed or disarmed, refer to page 30.

## Operating from the inside

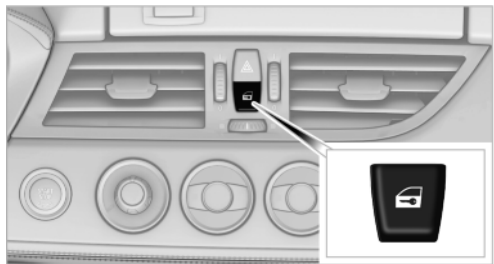

Via the button for the central locking system.

If the vehicle is locked from the inside, the fuel filler flap remains unlocked.

If an accident of a certain severity occurs, the central locking system unlocks automatically.

The hazard warning system and interior lamps come on.

## Opening and closing: from the outside

### Using the remote control

#### General information

 Take the remote control with you. People or animals left unattended in a parked vehicle can lock the doors from the inside. Always take the remote control with you when leaving the vehicle so that the vehicle can then be opened from the outside. ◀

Conditions for operating the retractable hardtop using the remote control:

- ▷ The doors and trunk lid are closed.
- ▷ The cargo area partition is folded down and engaged on both sides, refer to page 34.

#### Unlocking

 Press the button. The vehicle is unlocked. You can set how the vehicle is to be unlocked.

The setting is stored for the remote control currently in use.

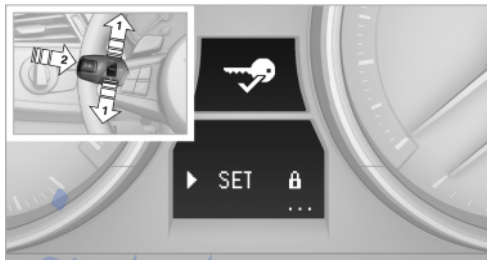

Operating principle, refer to page 62.

1. Switch on the ignition, refer to page 45.
2. Lightly push button 1 in the turn indicator lever up or down repeatedly until the symbol appears in the display, accompanied by the word "SET".



3. Press button 2.
4. Lightly push button 1 in the turn indicator lever down repeatedly until the symbol appears in the display.



5. Press button 2.
6. Use button 1 to select one of the following:
  - ▷  Only the driver's door and the fuel filler flap are unlocked. Pressing again unlocks the entire vehicle.
  - ▷  The entire vehicle is unlocked.
7. Press button 2.

### Convenient opening: Windows and hardtop

When you are close to the vehicle, the remote control for Comfort Access can be used to open the retractable hardtop.

 Press and hold the button on the remote control.

The windows and the retractable hardtop are opened if the doors are closed.

 Hold the button down. When you are close to the vehicle, the windows move up after the hardtop is opened.

 Monitor the opening process

Monitor the opening process to ensure that no one becomes trapped; otherwise, injuries may result. Releasing the button interrupts the opening process. ◀

### Locking

 LOCK Press the button on the remote control.

 Locking from the outside

Do not lock the vehicle from the outside if there are people in it, as the vehicle cannot be unlocked from inside without special knowledge. ◀

### Convenient closing

When you are close to the vehicle, the remote control for Comfort Access can be used to close the retractable hardtop and the windows.

 LOCK Press and hold the button on the remote control.

The retractable hardtop and the windows are closed.

 Monitor the closing process

Monitor the closing process to ensure that no one becomes trapped.

Releasing the button stops the motion. ◀

### Switching on the interior lamps and courtesy lamps

 LOCK Press the button on the remote control with the vehicle locked.

### Unlocking the trunk lid

 Press the button on the remote control for approx. one second.

During opening, the trunk lid pivots back and up.



Ensure that adequate clearance is available before opening.

To avoid locking yourself out of the vehicle, do not place the remote control into the cargo area. A previously locked trunk lid is locked again after closing.

Before and after each trip, check that the trunk lid has not been inadvertently unlocked.

### Convenient loading

When you are close to the vehicle, the remote control for Comfort Access can be used to partially tilt the open hardtop for more convenient loading of the trunk.

-  Briefly press the button on the remote control.  
Press again within one second and hold until the retractable hardtop stops in an intermediate position. The trunk lid opens slightly.
- Open the trunk lid, press the cargo area partition upward and stow the cargo in the cargo area.
- Press down the cargo area partition until it engages on both sides and close the trunk lid.
-  Press the button on the remote control for an extended period to fold the retractable hardtop back in.

## Confirmation signals from the vehicle

Operating principle, refer to page 62.

1. Switch on the ignition, refer to page 45.
2. Lightly push button 1 in the turn indicator lever up or down repeatedly until the symbol appears in the display, accompanied by the word "SET".

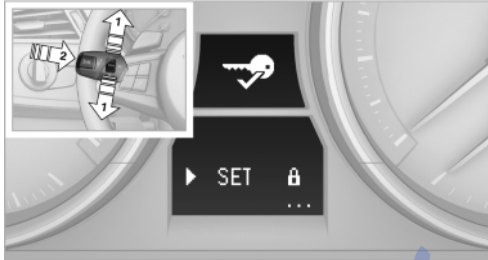

3. Press button 2.
4. Lightly push button 1 in the turn indicator lever down repeatedly until the desired symbol appears in the display.
  - ▷ Confirmation signal during unlocking
  - ▷ Confirmation signal during locking

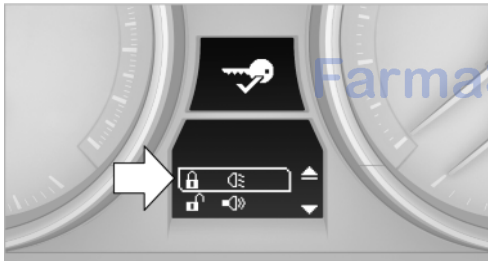

5. Press button 2.
6. Use button 1 to select one of the following:
  - ▷ The hazard warning system flashes during unlocking/locking.
  - ▷ An acoustic signal sounds during unlocking/locking.
  - ▷ The hazard warning system lights up and an acoustic signal sounds during unlocking/locking.

- ▷ **off** The function is deactivated.

7. Press button 2.

The setting is stored.

## Retrieving the seat and mirror settings

The driver's seat and exterior mirror positions used last are stored for the remote control currently in use.

When the vehicle is being unlocked, these positions are automatically retrieved if the setting is activated.

- Keep the footwell behind the driver's seat clear

When this Personal Profile function is used, first make sure that the footwell behind the driver's seat is free of obstacles. Failure to do so could result in damage to the objects if the seat were to move rearward. ◀

The adjustment procedure is interrupted:

- ▷ When a seat position switch is pressed.
- ▷ When a button of the seat and mirror memory is pressed briefly.

Operating principle, refer to page 62.

1. Lightly push button 1 in the turn indicator lever up or down repeatedly until the symbol appears in the display, accompanied by the word "SET".

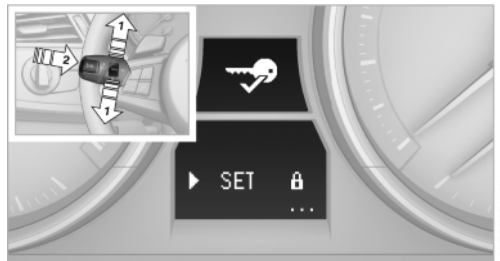

2. Press button 2.

- Lightly push button 1 in the turn indicator lever down repeatedly until the symbol appears in the display.

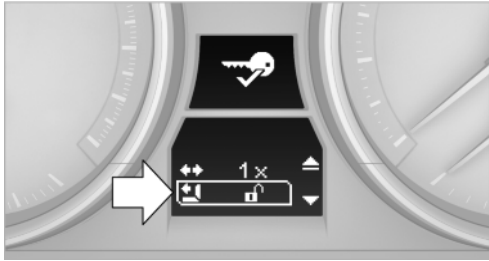

- Press button 2.
- Use button 1 to select one of the following:
  - Call-up when the vehicle is unlocked.
  - Call-up when the driver's door is opened.
  - Switch off the automatic function.
- Press button 2.  
The setting is stored.

## Malfunctions

Local radio waves may interfere with the remote control.

In this case, unlock and lock the car at the door lock with the integrated key.

In vehicles without an alarm system or Comfort Access, only the driver's door can be unlocked and locked using the integrated key in the door lock.

If the car can no longer be locked with a remote control, the battery in the remote control is discharged. Use the remote control during an extended drive in order to recharge the battery, refer to page 20.

The remote control for Comfort Access contains a battery that may need to be replaced, refer to page 30.

## For US owners only

The transmitter and receiver units comply with part 15 of the FCC/Federal Communication

Commission regulations. Operation is governed by the following:

FCC ID:

LX8766S

LX8766E

LX8CAS

Compliance statement:

This device complies with part 15 of the FCC Rules. Operation is subject to the following two conditions:

- This device may not cause harmful interference, and
- this device must accept any interference received, including interference that may cause undesired operation.

Any unauthorized modifications or changes to these devices could void the user's authority to operate this equipment.

## Using the door lock

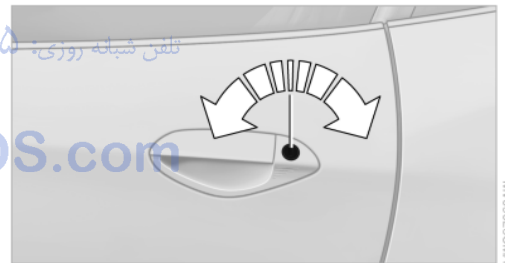

### ⚠ Locking from the outside

Do not lock the vehicle from the outside if there are people in it, as the vehicle cannot be unlocked from inside without special knowledge. ◀

### ⚠ Remove the key before pulling the door handle

Before pulling the outside door handle, remove the key to avoid damaging the paintwork and the key. ◀



## Convenient operation

In vehicles with an alarm system or Comfort Access, the windows and retractable hardtop can also be operated via the door lock.

## Opening/closing

With the door closed, turn the key to the unlock or lock position and hold it there.

Turning the key back to the original position stops the motion.



Monitor the closing process

During every closing procedure, and when opening the retractable hardtop, watch the process and ensure that no one becomes trapped; otherwise, injuries may occur. ◀

## Manual operation

If an electrical malfunction occurs, unlock or lock the driver's door using the integrated key in the door lock.

## Opening and closing: from the inside

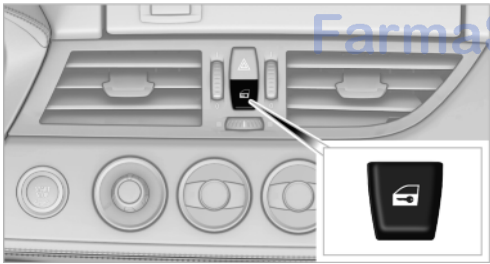

## Locking and unlocking



Press the button.

The doors and the trunk lid are locked or unlocked when the front doors are closed, but they are not secured against theft.

The fuel filler flap remains unlocked.

## Automatic locking

The setting is stored for the remote control currently in use.

Operating principle, refer to page 62.

1. Switch on the ignition, refer to page 45.
2. Lightly push button 1 in the turn indicator lever up or down repeatedly until the symbol appears in the display, accompanied by the word "SET".



3. Press button 2.
4. Lightly push button 1 in the turn indicator lever down repeatedly until the symbol appears in the display.

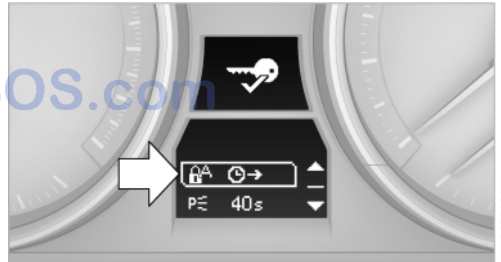

5. Press button 2.
6. Use button 1 to select one of the following:
  - ▷ on The vehicle locks automatically after a short period of time if a door is not opened.
  - ▷ on The vehicle locks automatically after you drive away.
  - ▷ The vehicle locks automatically after a short period of time if a door is not opened or after you drive away.

- ▶ **off** The central locking system remains unlocked.

7. Press button 2.

## Unlocking and opening doors

- ▶  Press the button. The doors are unlocked. To open, pull the door handle above the armrest.
- ▶ Pull the door handle above the armrest twice: the door is unlocked the first time and opened the second time.

## Locking

- ▶  Press the button. The doors are locked.
- ▶ Press the lock button of a door. To prevent you from being locked out, the opened driver's door cannot be locked using the lock button.

 Take the remote control with you  
People or animals left unattended in a parked vehicle can lock the doors from the inside. Always take the remote control with you when leaving the vehicle so that the vehicle can then be opened from the outside. ◀

## Trunk lid

 Note the opening height of the trunk lid  
During opening, the trunk lid pivots back and up. Ensure that there is sufficient clearance when the trunk lid opens; otherwise, damage may result. ◀

## Opening from the inside

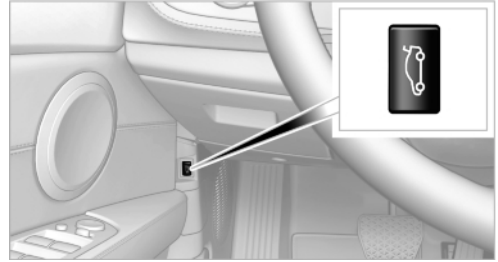

 Press the button.  
The trunk lid opens unless it has been locked.

## Opening from the outside



- ▶ Press on the top half of the BMW emblem.
- ▶  Press the button on the remote control for approx. one second.

The trunk lid can be opened.

## Closing



Recessed grips in the interior trim of the trunk lid make it easier to pull down the lid.



### Danger of pinching

Make sure that the closing path of the trunk lid is clear; otherwise, injuries may result. ◀

Press the trunk lid down lightly.

It is closed automatically.

## Emergency unlocking



Pull the lever in the cargo area.

The trunk lid unlocks.

## Comfort Access

### The concept

The vehicle can be accessed without activating the remote control.

All you need to do is to have the remote control with you, e.g., in your jacket pocket.

The vehicle automatically detects the remote control when it is nearby or in the passenger compartment.

Comfort Access supports the following functions:

- ▷ Unlocking/locking of the vehicle.
- ▷ Convenient closing.
- ▷ Convenient opening
- ▷ Unlocking of the trunk lid separately.
- ▷ Starting the engine.

### Functional requirement

- ▷ To lock the vehicle, the remote control must be located outside of the vehicle.

- ▷ The vehicle cannot be unlocked or locked again for approx. the next two seconds.
- ▷ The engine can only be started if the remote control is inside the vehicle.

## Comparison to the standard remote control

The specified functions can be controlled by pressing the button or via Comfort Access.

If you notice a brief delay while opening or closing the windows or retractable hardtop, the system is checking whether a remote control is inside the vehicle. Repeat the opening or closing procedure, if necessary.

### Unlocking

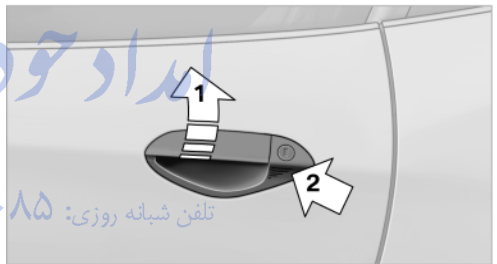

Pull the handle up, arrow 1. This corresponds to pressing the  button.

### Locking

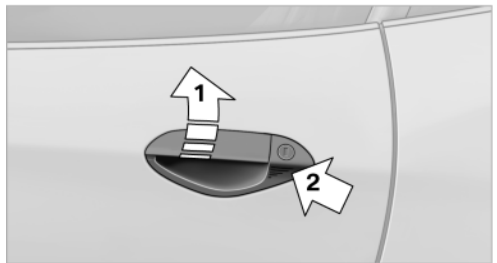

Press on the surface, arrow 2.

This corresponds to pressing the  LOCK button.

To save battery power, ensure that the ignition and all electronic systems and/or power con-

sumers are switched off before locking the vehicle.

### Window and convertible top operation

With the ignition in the radio ready state or beyond, the windows and the convertible top can be opened and closed when a remote control is located inside the vehicle.

### Unlocking the trunk lid separately

Press on the top half of the BMW emblem. This corresponds to pressing the  button.

If a remote control accidentally left in the trunk is detected in the locked vehicle, then the trunk lid opens again. The hazard warning system flashes and an acoustic signal sounds.

### Switching on the radio ready state

Pressing the Start/Stop button switches on the radio ready state, refer to page 45.

Do not depress the brake or the clutch; otherwise, the engine will start.

### Starting the engine

The engine can be started or the ignition can be switched on when a remote control is inside the vehicle. It is not necessary to insert a remote control into the ignition lock, refer to page 45.

### Switching off the engine in cars with Sport automatic transmission

When the engine is switched off, transmission position P is engaged automatically unless N is engaged and the remote control is inserted in the ignition lock.

### Driving into an automatic car wash with a Sport automatic transmission

To make it possible for the vehicle to roll, such as in an automatic car wash, follow the instructions in Car washes, refer to page 182.

### Malfunction

The Comfort Access functions can be disturbed by local radio waves, such as by a mobile phone in the immediate vicinity of the remote control or when a mobile phone is being charged in the vehicle.

If this occurs, open or close the vehicle using the buttons on the remote control or use the integrated key in the door lock.

To start the engine afterward, insert the remote control into the ignition switch.

### Warning lamps



The warning lamp in the instrument cluster lights up when you attempt to start the engine: the engine cannot be started.

The remote control is not inside the vehicle or is malfunctioning. Take the remote control with you inside the vehicle or have it checked. If necessary, insert another remote control into the ignition switch.



The warning lamp in the instrument cluster lights up while the engine is running: the remote control is no longer inside the vehicle.

After the engine is switched off, the engine can only be restarted within approx. 10 seconds.



The indicator lamp in the instrument cluster lights up: replace the remote control battery.

## Replacing the battery

The remote control for Comfort Access contains a battery that will need to be replaced from time to time.

1. Take the integrated key out of the remote control, refer to page 20.



2. Remove the cover.
3. Insert a battery of the same type with the positive side facing upwards.
4. Press the cover closed.

 Return used battery to a recycling collection point or to your service center.

## Alarm system

### The concept

The vehicle alarm system responds to:

- ▷ Opening of a door, the hood or the trunk lid.
- ▷ Movements in the vehicle: interior motion sensor, refer to page 31.
- ▷ When the car's inclination changes, for instance if an attempt is made to jack it up and steal the wheels or to raise it prior to towing away.
- ▷ Interruptions in battery voltage.

The alarm system signals unauthorized entry attempts for a short time by means of:

- ▷ By sounding an acoustic alarm.
- ▷ By switching on the hazard warning system.
- ▷ By flashing the high beams.

## Arming and disarming the alarm system

When you lock or unlock the vehicle, either with the remote control or at the door lock, the alarm system is armed or disarmed at the same time.

### Trunk lid and armed alarm system

The trunk lid can be opened using the remote control, even if the alarm system is armed.

 Press the button on the remote control for approx. one second.

 Note the opening height of the trunk lid. During opening, the trunk lid pivots back and up. Ensure that there is sufficient clearance when the trunk lid opens; otherwise, damage may result. ◀

After the lid is closed, it is locked and monitored again by the alarm system.

### Panic mode

You can trigger the alarm system if you find yourself in a dangerous situation.

 Press the button on the remote control for at least three seconds.

To switch off the alarm: press any button.

### Switching off the alarm

- ▷ Unlock the vehicle using the remote control, refer to page 22.
- ▷ Insert the remote control all the way into the ignition lock.

## Indicator lamp on the interior rearview mirror



- ▶ The indicator lamp flashes briefly every 2 seconds:  
The system is armed.
- ▶ The indicator lamp flashes after locking:  
The doors, hood or trunk lid is not closed properly, but the rest of the vehicle is secured.  
The indicator lamp flashes continuously after approx. 10 seconds. The interior motion sensor and tilt alarm sensor are not active.
- ▶ The indicator lamp goes out after unlocking:  
The vehicle has not been tampered with.
- ▶ If the indicator lamp flashes after unlocking until the remote control is inserted in the ignition, but for no longer than approx. 5 minutes:  
An alarm has been triggered.

## Tilt alarm sensor

The tilt of the vehicle is monitored.

The alarm system responds in situations such as attempts to steal a wheel or tow the car.

## Interior motion sensor

The interior of the car is monitored up to the height of the seat cushions. Thus the alarm system is activated together with the interior motion sensor even if the hardtop is open. An alarm can be triggered unintentionally by falling objects such as leaves, refer to Avoiding unintentional alarms.

## Avoiding unintentional alarms

The tilt alarm sensor and interior motion sensor can be switched off together, such as in the following situations:

- ▶ In duplex garages.
- ▶ During transport on car-carrying trains, at sea or on a trailer.
- ▶ When animals are to remain in the vehicle.

## Switching off the tilt alarm sensor and interior motion sensor

 **LOCK** Press the remote control button again within 10 seconds after the vehicle is locked.

The indicator lamp lights up for approx. 2 seconds and then continues flashing.

The tilt alarm sensor and interior motion sensor remain switched off until the vehicle is locked again.

## Power windows

### General information

 Take the remote control with you  
Take the remote control with you when leaving the vehicle so that children, for example, cannot operate the power windows and injure themselves. ◀

 Danger of pinching  
Monitor the closing process and make sure that the closing path of the window is clear; otherwise, injuries may result. ◀

## Opening, closing

### Individually



- ▷ Press the switch to the resistance point:  
The window opens while the switch is held. Closing can be performed in the same manner by pulling the switch.
- ▷ Press the switch beyond the resistance point:  
The window opens automatically. Press the switch again to stop the opening movement.

### Jointly

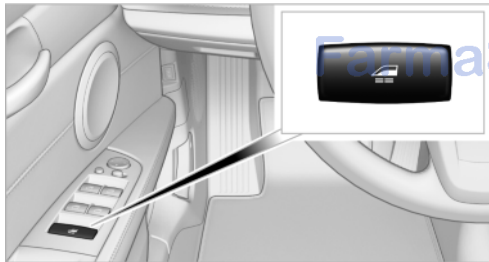

- ▷ Press the switch to the resistance point:  
All windows open while the switch is held. Closing can be performed in the same manner by pulling the switch.
- ▷ Press the switch beyond the resistance point:  
All windows open automatically. Press the switch again to stop the opening movement.

### Convenience operation

Convenience operation via the remote control, refer to page 22, or the door lock, refer to page 26.

Convenient closing with Comfort Access, refer to page 23.

### After the ignition is switched off

When the remote control is removed or the ignition is switched off, the windows can continue to be operated for approx. 1 minute as long as no door is opened.

### Pinch protection system

If the closing force exceeds a specific value as one of the front side windows closes, the closing action is interrupted.

The window reopens slightly.

 Danger of pinching even with pinch protection

Even with the pinch protection system, check that the window's closing path is clear; otherwise, the closing action may not stop in certain situations, e.g., if thin objects are present. ◀

 Do not use window accessories  
Do not install any accessories in the range of movement of the windows; otherwise, the pinch protection system will be impaired. ◀

### Closing without the pinch protection system

For example, if there is an external danger or if ice on the windows prevents a window from closing normally, proceed as follows:

1. Pull the switch past the resistance point and hold it there. Pinch protection is limited and the window reopens slightly if the closing force exceeds a certain value.
2. Pull the switch past the resistance point again within approx. 4 seconds and hold it there.



The window closes without pinch protection.

## Retractable hardtop

### General information

Adhere to the following instructions:

- ▷ It is advisable that you close the retractable hardtop when you park the vehicle. Not only does the closed hardtop protect the vehicle interior against unanticipated weather damage, it also offers theft protection. However, even when the hardtop is closed, valuables should only be stored in the locked cargo area.
- ▷ Do not attach roof rack systems to the retractable hardtop, and in particular do not attach magnetic racks.
- ▷ Do not attach rack systems to the trunk lid, and in particular do not attach magnetic racks.
- ▷ When the retractable hardtop is operated, the trunk lid swings back and up.

Before operating the retractable hardtop, ensure that there is enough clearance, e.g., in tight parking spaces.

- ▷ If you open the hardtop while it is wet, e.g., after driving in the rain, water may drip into the cargo area.  
If necessary, remove items from the cargo area beforehand to avoid water stains or soiling.
- ▷ At temperatures below 14 °F/-10 °C, the retractable hardtop cannot be moved.

 Do not touch the mechanism and keep the opening path clear.

During opening and closing, do not reach into the mechanism and keep children away from the opening path of the retractable hardtop; otherwise, there is the risk of injury. ◀



Only open or close the hardtop while the vehicle is stationary.

Do not drive away until the hardtop movement is completed. Driving when the hardtop is not fully opened or not fully closed may result in damage or injury. ◀



Do not place objects on the retractable hardtop.

Do not place any objects on the retractable hardtop or on the trunk lid; otherwise, they could fall during movements of the retractable hardtop and cause damage or injury. ◀

### Before opening and closing



Always open or close the hardtop fully.

Do not let the hardtop stop in an intermediate position when opening or closing. Otherwise, there is the danger of personal injury since the hardtop will be lowered automatically after a few minutes. ◀

- ▷ Observe the safety precautions above.
- ▷ Ensure that the trunk lid is closed.
- ▷ The vehicle should be parked on fairly level ground. Excessive angle is indicated by a lamp.
- ▷ Fold down the trunk cover and make sure it engages, refer to the instructions below.
- ▷ Do not place any objects next to or on the cargo area partition and close the storage compartment on the left side of the cargo area.
- ▷ Do not exceed the maximum loading height under the cargo area partition; refer to the label in the cargo area showing a line indicating the maximum height.

## Folding down the cargo area partition



Before opening the hardtop, close the cargo area partition, arrow, and make sure it engages on both sides.

## Opening and closing

In the radio ready state or beyond, refer to page 45, and when the vehicle is stationary:

If possible, conserve the battery by only operating the retractable hardtop when the engine is running. Before closing the retractable hardtop, remove all foreign objects from the windshield frame as these could prevent the hardtop from closing properly.

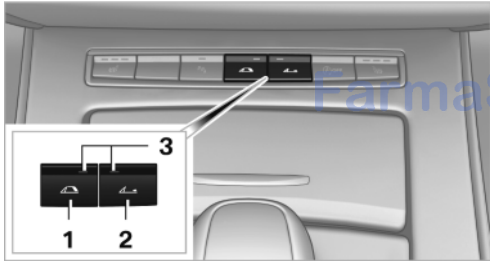

- 1 Press and hold button 1:  
The retractable hardtop closes.
- 2 Press and hold button 2:  
The retractable hardtop opens.
- 3 LEDs

The side windows move down when the hardtop is opened or closed.

If the windows pause briefly as they move, this is for technical reasons and is not a malfunction.

## LEDs

In the following situations, an acoustic signal may sound in addition to the LED lighting up:

- ▷ While the hardtop is being operated, the green LED lights up. It goes out as soon as the top is fully opened or closed.
- ▷ If the red LED flashes when you release the switch, the opening or closing action has not yet finished.
- ▷ If the red LED lights up when the switch is pressed, the cargo area partition is folded up, the trunk lid is not closed, the vehicle is standing on a strong incline or there is a malfunction. The retractable hardtop cannot be moved.

## Interruption

The automatic sequence of movements is interrupted if the switch for hardtop operation is released. The sequence can be continued in the desired direction by pushing or pulling the switch.



Always open or close the hardtop fully.

Open or close the hardtop fully; otherwise, there is a risk of injury or damage when driving. Do not interrupt and resume the closing procedure several times in close succession as this could damage the mechanism. ◀

If the hardtop is not fully opened or closed, the trunk lid cannot be opened and the windows cannot be moved.

## Convenient operation with remote control or via door lock

Information on convenient operation, refer to page 23, and on operation using the door lock, refer to page 26.

## Wind deflector

The wind deflector keeps air movements in the passenger compartment to a minimum when the hardtop is open and provides an even more comfortable ride, particularly at high speeds.

## Installation

1. Insert the wind deflector 1 into the holders 2 on the rollover bars; the arrow should point in the direction of travel.

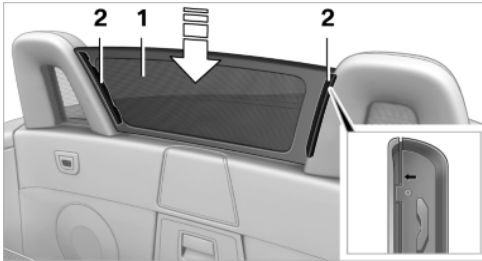

2. Push the wind deflector down, arrow 1, and then push down and forward simultaneously, arrow 2, until it engages.

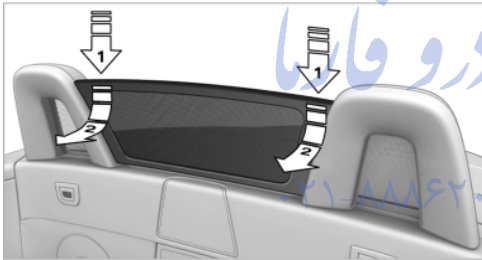

- !** Attach the wind deflector securely. The wind deflector must engage firmly; otherwise, it could become detached at higher vehicle speeds. ◀

## Removing

1. Push the wind deflector down and back simultaneously, arrow 1, to disengage it from the catch mechanism.

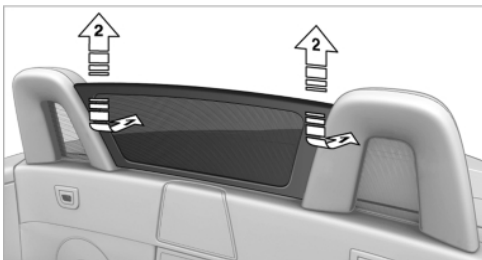

2. Pull the wind deflector upward out of the holders, arrow 2.

## Clothes hooks



Coat hooks 1 are located on the wind deflector panels in the rollover bars.

- !** Only hang light objects on the hooks. Do not hang heavy objects on the hooks; otherwise, they could endanger the passengers, such as during braking or evasive maneuvers. ◀

## Storage

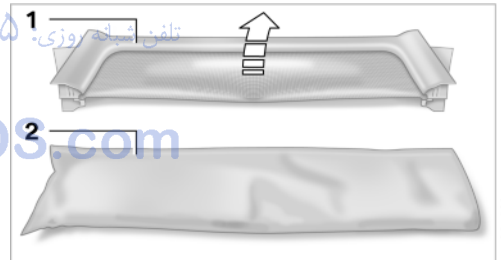

Fold the wind deflector 1 and slide it into the storage pouch 2.

The wind deflector can be stored on the lateral storage shelf behind the seats.

# Adjusting

## Vehicle equipment

This chapter describes all series equipment as well as country-specific and special equipment offered for this model series. Therefore, it also describes equipment that may not be found in your vehicle, for instance due to the selected special equipment or the country version. This also applies to safety-related functions and systems.

## Sitting safely

The ideal seating position can make a vital contribution to relaxed, fatigue-free driving.

The seating position plays an important role in an accident in combination with:

- ▷ Safety belts, refer to page 38.
- ▷ Head restraints.
- ▷ Airbags, refer to page 73.

## Seats

### Note before adjusting

 Do not adjust the seat while driving  
Never attempt to adjust the driver's seat while driving.

The seat could respond with unexpected movement and the ensuing loss of vehicle control could lead to an accident. ◀

 Do not incline the backrest too far to the rear

Do not incline the backrest on the front passenger side too far to the rear during driving. Otherwise, there is the danger of sliding under the safety belt in an accident. This would eliminate the protection normally provided by the belt. ◀

Also note the information on safety belt damage, refer to page 39.

### Adjusting manually

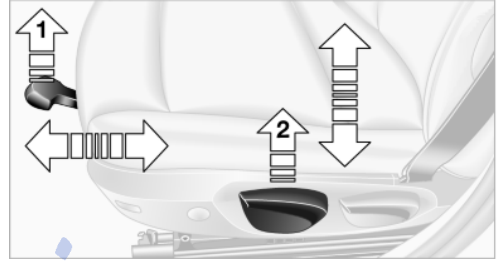

#### Forward/backward

Pull lever 1 and slide the seat to the desired position.

After releasing the lever, move the seat forward or back slightly to make sure it engages properly.

#### Height

Pull lever 2 and apply your weight to the seat or lift it off, as necessary.

#### Backrest tilt

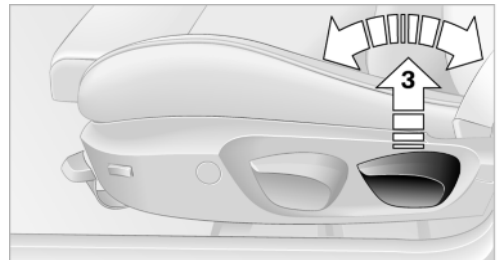

Pull lever 3 and move the backrest to the desired tilt.

Distance:

Adjust the backrest so that the head restraint is as close as possible to the back of the head.

## Seat tilt



Pull the lever and move the seat to the desired tilt. After releasing the lever, apply your weight to the seat or lift it off to make sure the seat engages properly.

## Thigh support

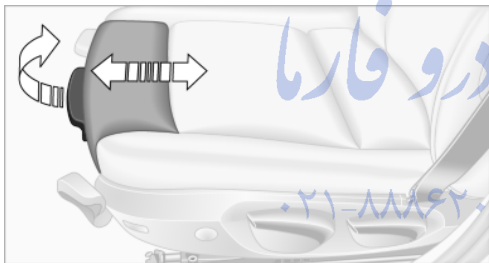

Pull the lever and move the thigh support forward or back.

## Adjusting electrically



- 1 Longitudinal direction
- 2 Height
- 3 Seat tilt



## 4 Backrest tilt

## Lumbar support

The curvature of the seat backrest can be adjusted in such a way that it supports the lumbar region of the spine.

The lower back and the spine are supported for upright posture.



- ▶ Press the front/rear section of the switch.  
The curvature is increased/decreased.
- ▶ Press the upper/lower section of the switch.  
The curvature is shifted up/down.

## Backrest width

Change the width of the backrest using the side wings to adjust the lateral support.



Press the front/rear section of the switch.  
The backrest width decreases/increases.

## Seat heating



Press the button once for each temperature level.

The maximum temperature is reached when three LEDs are lit.

If the trip is continued within approx. 15 minutes, the seat heating is activated automatically with the temperature set last.

### Switching off

Press the button longer.  
The LEDs go out.

## Safety belts

### General information

Always make sure that safety belts are being worn by all occupants before driving away.

Although airbags enhance safety by providing added protection, they are not a substitute for safety belts.

### Seats with safety belt

The vehicle has two seats, each of which is equipped with a safety belt.

The shoulder strap's anchorage point will be correct for adult seat occupants of every build if the seat is correctly adjusted.



One person per safety belt

Never allow more than one person to wear a single safety belt. Never allow infants or small children to ride on a passenger's lap. ◀



Putting on the belt

Lay the belt, without twisting, snugly across the lap and shoulders, as close to the body as possible. Make sure that the belt lies low around the hips in the lap area and does not press on the abdomen. Otherwise, the belt can slip over the hips in the lap area in a frontal impact and injure the abdomen.

The safety belt must not lie across the neck, rub on sharp edges, be routed over solid or breakable objects, or be pinched. ◀



Reduction of restraining effect

Avoid wearing clothing that prevents the belt from fitting properly, and pull the shoulder belt periodically to readjust the tension across your lap; otherwise, the retention effect of the safety belt may be reduced. ◀

## Buckling the belt

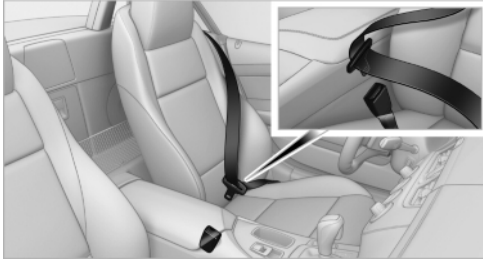

Make sure you hear the latch plate engage in the belt buckle.

## Unbuckling the belt

1. Hold the belt firmly.
2. Press the red button in the belt buckle.
3. Guide the belt back into its reel.

## Safety belt reminder for driver and passenger



The indicator lamp lights up and a signal sounds. Check whether the safety belt has been fastened correctly.

The safety belt reminder is active at speeds above approx. 5 mph/8 km/h. It can also be activated if objects are placed on the front passenger seat.

## Damage to safety belts

In the case of strain caused by accidents or damage:

Have the safety belts, including the safety belt tensioners, replaced and have the belt anchors checked.



Checking and replacing safety belts

Have the work performed only by your service center; otherwise, it cannot be ensured that this safety feature will function properly. ◀

## Seat and mirror memory

### General information

Two different driver's seat and exterior mirror positions can be stored and retrieved for each remote control.

Settings for the backrest width and lumbar support are not stored.

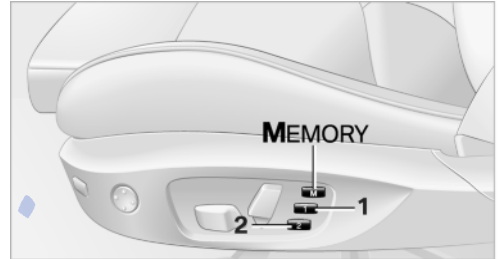

### Storing

1. Switch on the radio ready state or the ignition, refer to page 45.
2. Adjust the seat and exterior mirrors to the desired positions.
3.  Press the button. The LED in the button lights up.
4. Press the desired memory button 1 or 2: the LED goes out.

If the M button is pressed accidentally:

-  Press the button again. The LED goes out.

### Calling up settings



Do not retrieve the memory setting while driving

Do not retrieve the memory setting while driving, as an unexpected movement of the seat or steering wheel could result in an accident. ◀

## Comfort function

1. Open the driver's door or switch on the radio ready state, refer to page 45.
2. Briefly press the desired memory button 1 or 2.

The seat is automatically moved to the stored position.

The procedure stops when a switch for adjusting the seat or one of the buttons is pressed.

## Safety mode

1. Close the driver's door and switch the ignition on or off, refer to page 45.
2. Press and hold the desired button 1 or 2 until the adjustment procedure is completed.

## Mirrors

### Exterior mirrors

#### General information

The mirror on the passenger side is more curved than the driver's mirror.



Estimating distances correctly

Objects reflected in the mirror are closer than they appear. Do not estimate the distance to the traffic behind you based on what you see in the mirror, as this will increase your risk of an accident. ◀

The setting for the exterior mirrors is stored for the remote control currently in use. The stored position is called up automatically when the vehicle is unlocked.

## At a glance

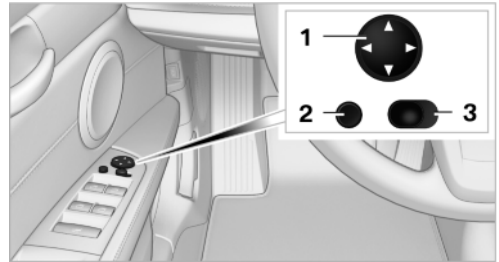

- 1 Adjusting
- 2 Fold in and out
- 3 Left/right, Automatic Curb Monitor

## Selecting a mirror

To change over to the other mirror:

Slide over the mirror changeover switch 3.

## Adjusting electrically



The setting corresponds to the direction in which the button is pressed.

## Saving positions

Seat and mirror memory, refer to page 39.

## Adjusting manually

If an electrical malfunction occurs, for example, press the edges of the mirror glass.

## Automatic Curb Monitor

When the reverse gear is engaged, the mirror glass tilts downward slightly on the front passenger side. This improves your view of the curb and other low-lying obstacles when parking, for example.



## Activating

- Slide the mirror changeover switch to the driver's side mirror position, arrow 1.

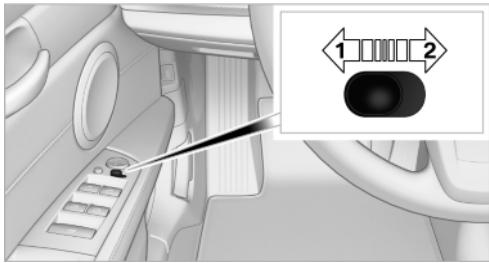

- Shift into reverse or engage transmission position R.

## Deactivating

Slide the mirror changeover switch to the passenger side mirror position, arrow 2.

## Fold in and out

Press button 2.

Possible up to approx. 15 mph/20 km/h.

For example, this is advantageous

- In car washes.
- In narrow streets.
- For folding back mirrors that were folded away manually.

Mirrors that were folded in are folded out automatically at a speed of approx. 25 mph/40 km/h.



Fold in the mirror in a car wash

Before entering an automatic car wash, fold in the exterior mirrors by hand or with the button; otherwise, they could be damaged, depending on the width of the vehicle. ◀

## Automatic heating

Both exterior mirrors are heated automatically while the engine is running or the ignition is switched on.

## Interior rearview mirror

### Reducing the blinding effect

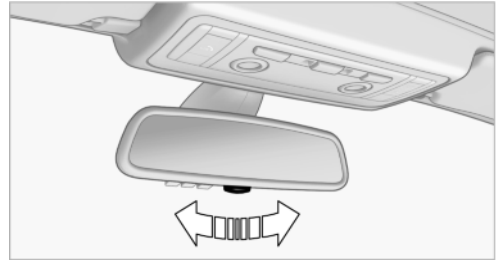

Blinding effect from behind when driving at night: turn the knob.

### Interior rearview and exterior mirrors, automatic dimming feature

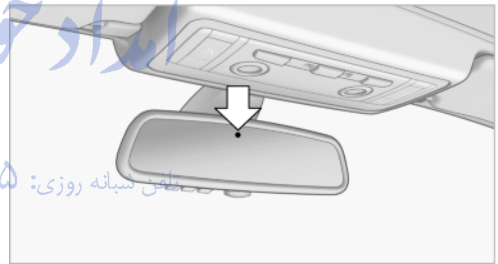

The automatic dimming feature of the interior rearview and exterior mirrors is controlled by two photo cells in the interior rearview mirror. One photo cell is in the mirror frame, see arrow; the other is on the back of the mirror.

For proper operation:

- Keep the photocells clean.
- Do not cover the area between the inside rearview mirror and the windshield.

## Steering wheel

- ▷ On: the LED lights up.
- ▷ Off: the LED goes out.

### General information

-  Do not adjust while driving
- Do not adjust the steering wheel while driving; otherwise, an unexpected movement could result in an accident. ◀

### Adjusting

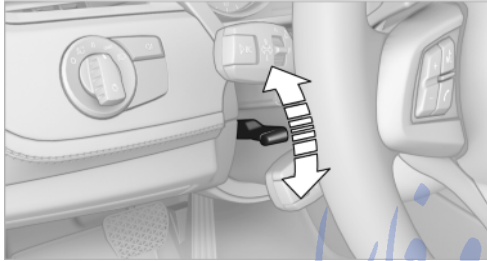

1. Fold the lever down.
2. Move the steering wheel to the preferred height and angle to suit your seating position.
3. Fold the lever back.

-  Do not use force to swing the lever back.
- Do not use force to swing the lever back up; otherwise, the mechanism will be damaged. ◀

### Steering wheel heating

#### Switching on/off

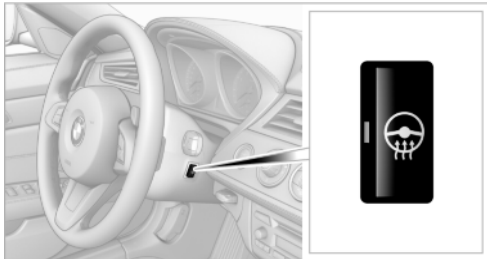

Press the button.

# Transporting children safely

## Vehicle equipment

This chapter describes all series equipment as well as country-specific and special equipment offered for this model series. Therefore, it also describes equipment that may not be found in your vehicle, for instance due to the selected special equipment or the country version. This also applies to safety-related functions and systems.

## The right place for children

### Note

 Children in the vehicle  
Do not leave children unattended in the vehicle; otherwise, they could endanger themselves and other persons, e.g., by opening the doors. ◀

### Children on the front passenger seat

Should it be necessary to use a child restraint fixing system on the front passenger seat, make sure that the front and side airbags on the front passenger side are deactivated. Automatic deactivation of front passenger airbags, refer to page 74.

 Deactivating the front passenger airbags  
If a child restraint fixing system is used in the front passenger seat, the front passenger airbags must be deactivated; otherwise, there is an increased risk of injury to the child when the airbags are triggered, even with a child restraint fixing system. ◀

 Transport children in suitable child restraint fixing systems

Only transport children younger than 13 years of age or shorter than 5 ft/150 cm in child restraint fixing systems suitable for the age,

weight and size of the child; otherwise, there is an increased risk of injury in an accident.

Children 13 years of age or older must wear a safety belt as soon as a suitable child restraint fixing system can no longer be used, due to their age, weight and size. ◀

## Installing child restraint fixing systems

### Notes

 Manufacturer's information for child restraint fixing systems

To select, mount and use child restraint fixing systems, observe the information provided by the system manufacturer; otherwise, the protective effect can be impaired. ◀

Standard child restraint systems are designed to be secured with a lap belt or with the lap-belt section of a lap-and-shoulder belt. Incorrectly or improperly installed child restraint systems can increase the risk of injury to children. Always follow the installation instructions for the system with the greatest care.

### on the front passenger seat

 Check the deactivation of the passenger airbag

After installing a child restraint fixing system on the passenger seat, make sure that the front and side airbags on the passenger side have been deactivated; otherwise, there is an increased risk of injury when the airbags are deployed. ◀

### Seat position

Before installing a child restraint fixing system, move the passenger seat as far back and as high as possible to obtain the best possible position for the belt.

### Backrest width

1. Adjust the backrest width to its widest setting, refer to page 37.
2. Install the child seat.



#### Backrest width for the child seat

Before installing a child restraint fixing system in the front passenger seat, the backrest width must be opened completely. Do not change the adjustment after this; otherwise, the stability of the child seat will be reduced. ◀

### Child restraint fixing system with tether strap

For Canadian Customers only

The following statement is required by Transport Canada

This vehicle is not equipped with user-ready tether anchorages. As such neither a child restraint system, nor a booster cushion, requiring the use of a tether strap can be properly secured in the vehicle.

### Child seat security



The safety belt for the passenger can be locked to prevent it from being pulled out when it is used to secure child restraint systems.

#### To lock the safety belt

1. Secure the child restraint fixing system with the belt.
2. Pull out the belt webbing completely.
3. Allow the belt webbing to be pulled in and pull it taut against the child restraint fixing system.

The safety belt is locked.

#### To unlock the safety belt

1. Open the belt buckle.
2. Remove the child restraint fixing system.
3. Allow the belt webbing to be pulled in completely.

امداد خود و فارما

تلفن شبانه روزی: ۰۸۵ ۲۰۸۵

FarmaSOS.com

# Driving

## Vehicle equipment

This chapter describes all series equipment as well as country-specific and special equipment offered for this model series. Therefore, it also describes equipment that may not be found in your vehicle, for instance due to the selected special equipment or the country version. This also applies to safety-related functions and systems.

## Ignition lock

### Insert the remote control into the ignition lock

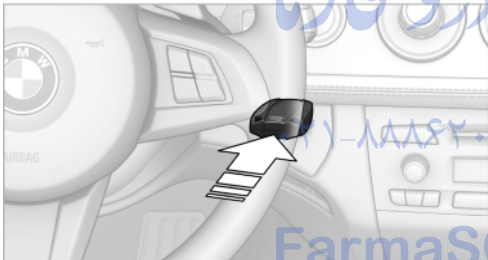

Insert the remote control all the way into the ignition lock.

- ▷ Radio ready state is switched on. Individual electrical consumers can operate.

### Comfort Access

If the car is equipped with Comfort Access, only insert the remote control into the ignition lock, refer to page 28, under special circumstances.

### Removing the remote control from the ignition lock



Do not forcibly pull the remote control out of the ignition lock

Do not forcibly pull the remote control out of the ignition lock as this may cause damage. ◀

Before removing the remote control, push it all the way in to release the locking mechanism.

- ▷ The ignition is switched off if it was on.

### Sport automatic transmission

When the remote control is removed from the ignition lock, transmission position P is engaged automatically. To make it possible for the vehicle to roll, such as in an automatic car wash, follow the instructions in Car washes, refer to page 182.

## Start/Stop button

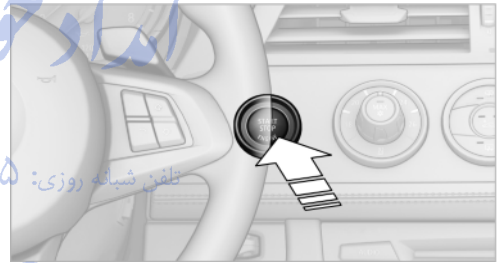

Pressing the Start/Stop button switches the radio ready state or the ignition on and off.

The engine starts when you press the Start/Stop button and, if the car has manual transmission, also depress the clutch, or, if the car has automatic transmission, also depress the brake.

### Radio ready state

Individual electrical consumers can operate. The time and the external temperature are displayed in the instrument cluster.

Radio ready state is switched off automatically:

- ▷ When the remote control is removed from the ignition lock.
- ▷ In cars with Comfort Access, by touching the surface above the door lock, locking, refer to page 28.

## Ignition on

All electrical consumers can operate. The odometer and trip odometer are displayed in the instrument cluster.

To save battery power when the engine is off, switch off the ignition and any unnecessary electronic systems/power consumers.

## Radio ready state and ignition off

All indicator and warning lamps as well as displays in the instrument cluster go out.

## Sport automatic transmission

In certain situations, transmission position P is engaged automatically. To make it possible for the vehicle to roll, such as in an automatic car wash, follow the instructions in Car washes, refer to page 182.

## Starting the engine

### Enclosed areas

Do not let the engine run in enclosed areas; otherwise, breathing of exhaust fumes may lead to loss of consciousness and death. The exhaust gases contain carbon monoxide, an odorless and colorless but highly toxic gas. ◀

### Unattended vehicle

Do not leave the car unattended with the engine running; otherwise, it presents a potential source of danger.

Before leaving the car with the engine running, set the parking brake and place the transmission in position P or neutral to prevent the car from moving. ◀

### Frequent starting in quick succession

Avoid repeated futile attempts at starting the car and avoid starting the car frequently in quick succession. Otherwise, the fuel is not burned or is inadequately burned, and there is the danger of overheating and damaging the catalytic converter. ◀

Do not wait for the engine to warm up while the vehicle remains stationary. Start driving right away, but at moderate engine speeds.

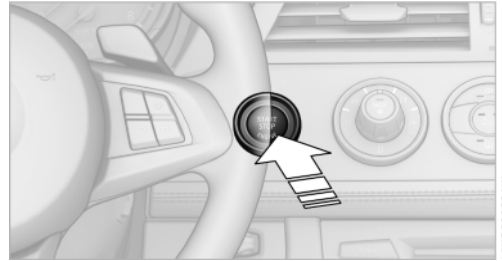

MAN02095001A

## Manual transmission

Remote control in the ignition lock or, with Comfort Access, inside the vehicle, refer to page 28.

1. Depress the brake pedal.
2. Press on the clutch and shift to neutral.
3. Press the Start/Stop button.

The starter operates automatically for a certain time, and stops automatically as soon as the engine has started.

## Sport automatic transmission

Remote control in the ignition lock or, with Comfort Access, inside the vehicle, refer to page 28.

1. Depress the brake pedal.
2. Press the Start/Stop button.

The starter operates automatically for a certain time, and stops automatically as soon as the engine has started.

## Engine stop

### Take the remote control with you

Take the remote control with you when leaving the vehicle so that children, for example, cannot start the engine or release the parking brake. ◀



Set the parking brake and further secure the vehicle as required

Set the parking brake firmly when parking; otherwise, the vehicle could roll. On steep upward and downward inclines, further secure the vehicle, for example, by turning the steering wheel in the direction of the curb. ◀

### Manual transmission

1. With the vehicle at a standstill, press the Start/Stop button.
2. Shift into first gear or reverse.
3. Set the parking brake.
4. Remove the remote control from the ignition lock, refer to page 45.

### Sport automatic transmission

1. With the vehicle at a standstill, press the Start/Stop button.
2. Set the parking brake.
3. Remove the remote control from the ignition lock, refer to page 45.

## Automatic Engine Start/Stop Function

### The concept

The Automatic Engine Start/Stop Function helps save fuel and lower emissions. The system automatically switches off the engine during a stop, e.g., in a traffic congestion or at traffic lights. The ignition remains switched on. The engine starts again automatically when the clutch is pressed.

### Automatic operation

The automatic engine start/stop function is operational after each engine start. It is activated whenever you drive forward faster than 3 mph/ 5 km/h.

### Automatic engine stop

The engine is switched off automatically during a stop under the following conditions:

- ▶ Neutral gear is engaged and the clutch pedal is not depressed.
- ▶ The driver's safety belt is fastened or the driver's door is closed.

When the engine is switched off, the air volume of the air conditioner or automatic climate control is reduced.

### Indicator lamp in the instrument cluster



The indicator lamp lights up when the Auto Start/Stop function is ready to start the engine automatically.

More information, refer to page 186.

### Note

The engine is not switched off automatically in the following situations:

- ▶ External temperatures below approx. 37 °F/ +3 °C.
- ▶ High external temperature and operation of the automatic climate control.
- ▶ The interior is not yet heated or cooled as much as desired.
- ▶ The engine is not yet at operating temperature.
- ▶ Sharp steering angle or the steering wheel is being turned.
- ▶ After driving in reverse.
- ▶ Fogging of the windows when the automatic climate control is switched on.
- ▶ Vehicle battery charge is very low.
- ▶ Hood is unlocked.

## Parking the vehicle during an automatic engine stop

The vehicle can be parked safely during an automatic engine stop, such as when you wish to leave the vehicle.

1. Press the Start/Stop button. The ignition is switched off. The Auto Start/Stop function is deactivated.
2. Set the parking brake.

Start the engine as usual using the Start/Stop button.

## Automatic engine start

To drive away, the engine starts automatically as soon as the clutch pedal is depressed.

After the engine starts, accelerate as usual.

## Safety mode

The engine does not start by itself after it is switched off automatically if any of the following conditions are fulfilled:

- ▷ The driver's safety belt is unfastened or the driver's door is open.
- ▷ Hood was unlocked.



The indicator lamp lights up.

The engine can only be started via the Start/Stop button.

More information, refer to page 186.

## Note

Even if you do not wish to drive away, the stopped engine still starts automatically in the following situations:

- ▷ The interior has heated up strongly with the cooling function switched on.
- ▷ The steering wheel is turned.
- ▷ The vehicle begins to roll.
- ▷ Fogging of the windows when the automatic climate control is switched on.
- ▷ Vehicle battery charge is very low.

- ▷ The interior has cooled down strongly with the heating switched on.
- ▷ Low braking pressure, such as from depressing the brake pedal a number of times consecutively.

## Activating/deactivating the system manually



Press the button.

- ▷ LED on the button lights up: the Auto Start/Stop function is deactivated.

The engine is started during an automatic engine stop.

The engine can only be stopped or started via the Start/Stop button.

- ▷ LED goes out: the Auto Start/Stop function is activated.

## Automatic deactivation

In certain situations, the Auto Start/Stop function is deactivated automatically in the interest of safety, for example if the driver's absence is detected.

## Malfunction



The automatic engine start/stop function no longer switches of the engine automatically. The indicator lamp lights up. It is possible to continue driving. Have the system checked.

More information, refer to page 186.



## Parking brake

### The concept

Your vehicle is equipped with an electromechanical parking brake that can be set and released by using a button.

The parking brake is primarily used to prevent the vehicle from rolling when it is parked.

When the vehicle is stationary, the parking brake acts on the rear wheels via an electromechanical mechanism. When the vehicle is rolling or being driven, the parking brake acts on the disc brakes of the front and rear wheels via the hydraulic brake system.

### Setting

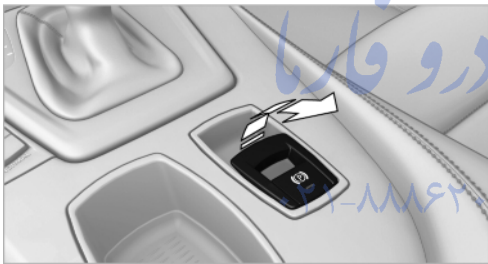

Pull the button. The parking brake is set.

**PARK** The indicator lamp in the instrument cluster and the LED on the button light up red. The parking brake is set.

**(P)** Indicator lamp in Canadian models.

To set the parking brake, the remote control does not need to be in the ignition lock.

### While driving

If exceptional circumstances should make it necessary to engage the parking brake while the vehicle is in motion, pull the button for an extended period: the vehicle brakes forcefully while the button is being pulled.

**PARK** The indicator lamp in the instrument cluster lights up red, a sound is issued and the brake lights light up.

**(P)** Indicator lamp in Canadian models.

When the vehicle is braked almost to a halt, approx. 2 mph/3 km/h, the parking brake remains set.

### Releasing

**!** Take the remote control with you  
Take the remote control with you when leaving the vehicle so that children, for example, cannot start the engine or release the parking brake. ◀

The parking brake can only be released while the ignition is switched on or the engine is running.



### Manual transmission

Press the button of the parking brake. Depress the brake and clutch pedals while doing so.

### Sport automatic transmission

Press the parking brake button while the brake is depressed or transmission position P is engaged.

### Indicator lamps

**PARK** The indicator lamp in the instrument cluster goes out.



Indicator lamp in Canadian models.

## Malfunction

In the event of a failure or malfunction of the parking brake, secure the vehicle against rolling using a wheel chock, for example, if you leave the vehicle.

## Turn signals/ headlamp flasher

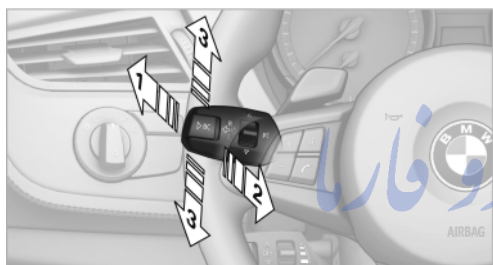

- 1 High beams
- 2 Headlamp flasher
- 3 Turn signal

## Using turn signals

Press the lever beyond the resistance point.

To switch off manually, press the lever to the resistance point.

Unusually rapid flashing of the indicator lamp indicates that a turn signal bulb has failed.

## Signaling a turn briefly

Press the lever to the resistance point and hold it there for as long as you want the turn signal to flash.

## Triple turn signal activation

Press the lever to the resistance point. The turn signal flash once.

You can be set whether the turn signal should flash once or three times when activated.

1. Switch on the ignition, refer to page 45.
2. Lightly push button 1 in the turn indicator lever up or down repeatedly until the symbol appears in the display, accompanied by the word "SET".

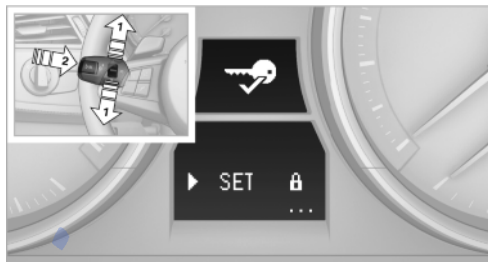

3. Press button 2.
4. Lightly push button 1 in the turn indicator lever down repeatedly until the symbol appears in the display.

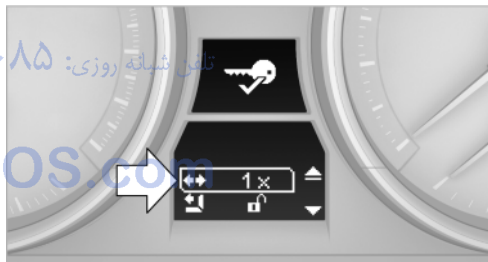

5. Press button 2.
6. Use button 1 to select one of the following:
  - ▷ 1 x Turn signal flashes once.
  - ▷ 3 x Triple turn signal.
7. Press button 2.

The setting is stored for the remote control currently in use.

The setting is stored for the remote control currently in use.

## Washer/wiper system

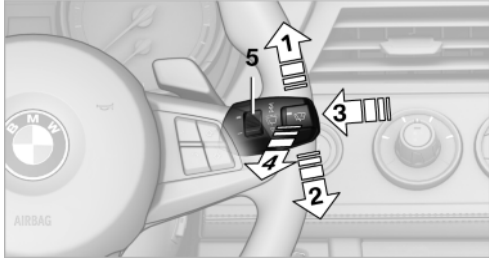

- 1 Switching on wipers
- 2 Switching off wipers or brief wipe
- 3 Activating/deactivating intermittent wipe or the rain sensor
- 4 Cleaning the windshield and headlamps
- 5 Setting speed for intermittent wipe or sensitivity of the rain sensor

### Switching on wipers

Press the lever upward, arrow 1.

The lever automatically returns to its initial position when released.

### Normal wiper speed

Press once.

The system switches to operation in the intermittent mode when the vehicle is stationary.

### Fast wiper speed

Press twice or press beyond the resistance point.

The system switches to normal speed when the vehicle is stationary.

### Intermittent wipe or rain sensor

If the car is not equipped with a rain sensor, the intermittent-wipe time is a preset.

If the car is equipped with a rain sensor, the time between wipes is controlled automatically and depends on the intensity of the rainfall. The rain sensor is mounted on the windshield, directly in front of the interior rearview mirror.

## Activating intermittent wipe or rain sensor

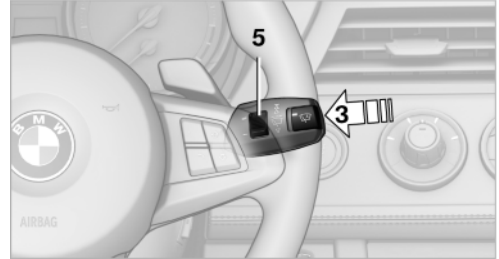

Press the button, arrow 3. The LED in the button lights up.

### Setting speed for intermittent wipe or sensitivity of the rain sensor

Turn thumbwheel 5 up or down.

### Deactivating intermittent wipe or rain sensor

Press the button again, arrow 3. The LED in the button goes out.



Deactivate the rain sensor in car washes  
Deactivate the rain sensor when passing through an automatic car wash; otherwise, damage could be caused by undesired wiper activation. ◀

### Cleaning the windshield and headlamps

Pull the lever, arrow 4.

The system sprays washer fluid on the windshield and activates the wipers briefly.

When the vehicle lighting system is switched on, the headlamps are cleaned at regular and appropriate intervals.



Do not use the washer system at freezing temperatures

Do not use the washers if there is any danger that the fluid will freeze on the windshield; otherwise, your vision could be obscured. For this reason, use antifreeze.

Avoid using the washer when the reservoir is empty; otherwise, you could damage the pump. ◀

### Windshield washer nozzles

The windshield washer nozzles are heated automatically while the engine is running or the ignition is switched on.

## Washer fluid

### General information

 Antifreeze for washer fluid  
Antifreeze is flammable. Therefore, keep it away from sources of ignition.

Only keep it in the closed original container and inaccessible to children.

Follow the instructions on the container. ◀

### Washer fluid reservoir

 Adding washer fluid  
Only add washer fluid when the engine is cool, and then close the cover completely to avoid contact between the washer fluid and hot engine parts.

Otherwise, there is the danger of fire and a risk to personal safety if the fluid is spilled. ◀

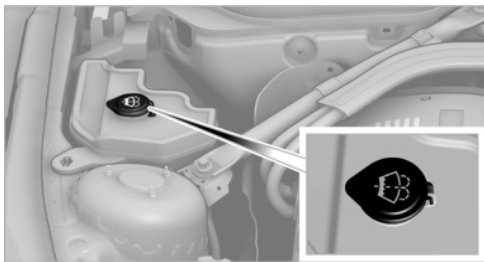

All washer nozzles are supplied from one reservoir.

Fill with water and – if required – with a washer antifreeze, according to the manufacturer's recommendations.

Mix the washer fluid before adding to maintain the correct mixing ratio.

### Capacity

Approx. 6.3 US quarts/6 liters.

## Manual transmission

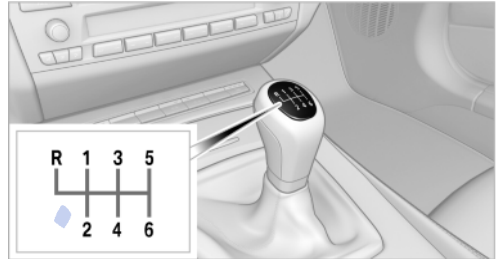

 Pay attention to the shift plane  
When shifting into 5th or 6th gear, push the gearshift lever to the right; otherwise inadvertent shifting into the 3rd or 4th gear could lead to engine damage. ◀

### Reverse gear

Select only when the vehicle is stationary. When the gearshift lever is pressed to the left, a slight resistance needs to be overcome.

### Malfunction

 The warning lamp lights up yellow. In addition, a signal sounds.

The clutch temperature is too high.

More information, refer to page [186](#).

## 8-gear Sport automatic transmission

### Transmission positions

#### D Drive, automatic position

Position for normal vehicle operation. All forward gears are available.

Under normal operating conditions, fuel consumption is lowest when you are driving in position D.

#### Kickdown

Kickdown is used to achieve maximum driving performance. Press on the accelerator beyond the resistance point at the full throttle position.

#### R is Reverse

Select only when the vehicle is stationary.

#### N is Neutral

The vehicle can roll.

N remains engaged after the engine is switched off if the remote control remains in the ignition lock. This function can be used in an automatic car wash, refer to page 182, for example. P is automatically engaged after approx. 30 minutes.

#### P Park

The rear wheels are locked.

P is engaged automatically when the following conditions are met:

- ▶ The driver's door is opened while the engine is running, the safety belt is not fastened and neither the brake pedal nor the accelerator is activated.
- ▶ The engine is switched off unless N is engaged and the remote control is in the ignition lock.
- ▶ The remote control is removed from the ignition lock, refer to page 45.

Before leaving the vehicle, ensure that the transmission position P is engaged; otherwise, the vehicle may begin to roll.

### Engaging transmission position

- ▶ Transmission position P can only be disengaged if the engine is running and the brake pedal is pressed.
- ▶ With the vehicle stationary, press on the brake pedal before shifting out of P or N; otherwise, the shift command will not be executed: shift lock.



Press on the brake pedal until you start driving

To prevent the vehicle from creeping after you select a driving position, maintain pressure on the brake pedal until you are ready to start. ◀

### Engaging transmission positions D, R, N

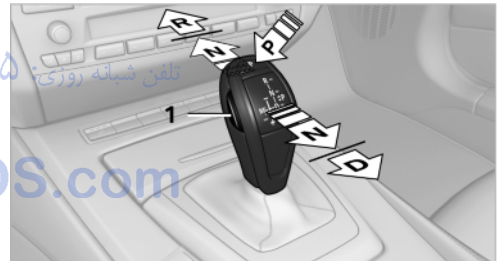

Briefly push the selector lever in the desired direction, beyond a resistance point if necessary. When shifting out of P or into R, simultaneously push the unlock button 1.

The engaged transmission position is displayed on the selector lever.

After releasing the selector lever, it returns to its center position.

### Engaging transmission position P

Select only when the vehicle is stationary.



Press button P.

## Sport program and manual mode M/S

### Activating the sport program

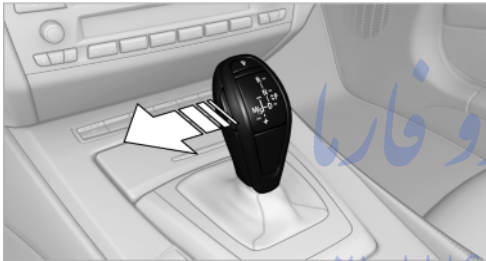

Push the selector lever to the left out of transmission position D.

The sport program is activated and DS is displayed in the instrument cluster.

This position is recommended for a performance-oriented driving style.

### Activating manual mode

Push the selector lever to the left out of transmission position D.

Push the selector lever forward or backward.

Manual mode becomes active and the gear is changed.

The engaged gear is displayed in the instrument cluster, e.g., M1.

- ▶ To shift down: press the selector lever forward.
- ▶ To shift up: press the selector lever backward.

The transmission only shifts up or down if the rpm and vehicle speed are appropriate. If the engine speed is too high, the transmission does not shift down.

The selected gear is briefly displayed in the instrument panel, followed by the current gear.

### Avoiding automatic upshifting

When the maximum engine speed is reached, the transmission automatically shifts up when in M/S manual mode.

These automatic shifting procedures are not performed and kickdown is deactivated if one of the following conditions is fulfilled:

- ▶ DSC is deactivated.
- ▶ TRACTION is activated.
- ▶ SPORT+ is activated.

Dynamic Driving Control, refer to page 82

### Ending the sport program/manual mode

Push the selector lever to the right.

D is displayed in the instrument cluster.

### Shifting gears using the shift paddles on the steering wheel

The shifting paddles make it possible to quickly change gears since both hands can remain on the steering wheel.

- ▶ If the shift paddles on the steering wheel are used to shift gears while in automatic mode D, the transmission temporarily switches to manual mode.
- ▶ If the shift paddles are not used to accelerate or shift gears for a certain amount of time, the transmission switches back to automatic mode D.

With the transmission position M/S selected, the manual mode remains active.

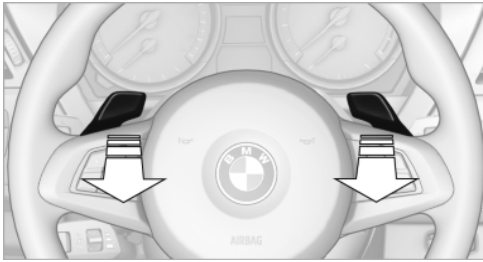

- ▷ Shift up: pull right shift paddle.
- ▷ Shift down: pull left shift paddle.

The vehicle only shifts up or down at appropriate engine and road speeds, e.g., it does not shift down if the engine speed is too high.

The selected gear is briefly displayed in the instrument cluster, followed by the current gear.

### Displays in the instrument cluster

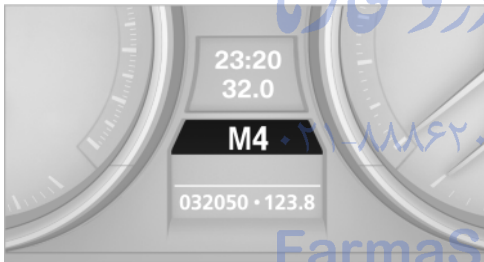

The gear position is displayed and the engaged gear, such as M4, is displayed in manual mode.

## 7-gear Sport automatic transmission with dual clutch

### The concept

This transmission is an automated manual transmission with two clutches and two gearbox components in which the gears are changed without loss of torque.

The transmission is operated using the selector lever and two shift paddles on the steering wheel.

Functions:

- ▷ Choice of manual or automatic operation: manual mode or drive mode.
- ▷ Automatic downshifting and protection against selecting the wrong gear, even in manual mode.
- ▷ Acceleration assistant, Launch Control, refer to page 58.
- ▷ Automatic throttle blip.

### System limits

This transmission is equipped with an overheating protection system that protects the clutches against extremely high loads.



The indicator lamp lights up yellow if the transmission becomes too warm. Avoid high engine loads and driving off frequently.

If the transmission overheats, the indicator lamp lights up red and power flow to the engine is interrupted. You can only continue driving after the transmission has cooled down.

Avoid driving off frequently with high acceleration and do not hold the vehicle on inclines by depressing the accelerator lightly; otherwise, the transmission may overheat.

### Transmission positions

P R N D M/S + -

### Displays in the instrument cluster

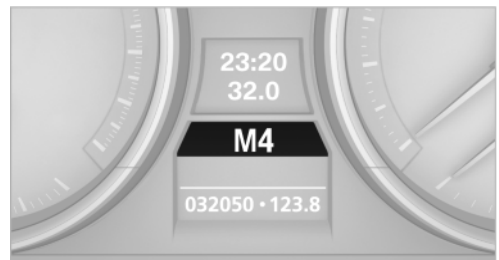

The gear position and the engaged gear, such as M4, are displayed.



## Engaging transmission positions N, D, R

- ▷ Transmission position P can only be disengaged if the engine is running.
- ▷ Before moving the lever away from P or N with the vehicle stationary, depress the brake; otherwise, the transmission will not shift.

 Press on the brake pedal until you start driving

To prevent the vehicle from creeping after you select a driving position, maintain pressure on the brake pedal until you are ready to start. ◀

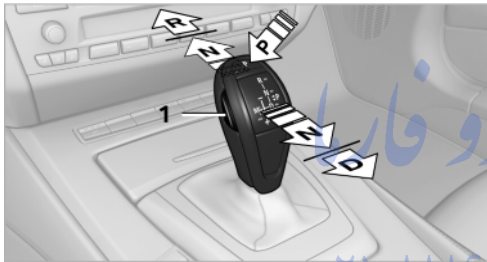

Briefly push the selector lever in the desired direction, beyond a resistance point if necessary. When shifting out of P or into R, press button 1 at the same time.

The engaged transmission position is also displayed on the selector lever.

When you release the selector lever, it returns to its center position.

## N is Neutral

The vehicle can roll.

N remains engaged after the engine is switched off if the remote control remains in the ignition lock. This function can be used in an automatic car wash, refer to page 182, for example. P is automatically engaged after approx. 30 minutes.

## D drive mode

In drive mode, all forward gears are shifted automatically.

## R is Reverse

Select only when the vehicle is stationary.

## P Park

The rear wheels are locked.

P is engaged automatically when the following conditions are met:

- ▷ The driver's door is opened while the engine is running, the safety belt is not fastened and neither the brake pedal nor the accelerator is activated.
- ▷ The engine is switched off unless N is engaged and the remote control is in the ignition lock.
- ▷ The remote control is removed from the ignition lock, refer to page 45.

Before leaving the vehicle, ensure that the transmission position P is engaged; otherwise, the vehicle may begin to roll.

## Engaging transmission position P

Select only when the vehicle is stationary.



Press button P.

## Kickdown

Kickdown is used to achieve maximum driving performance. Press the accelerator past the resistance point.



## Sport program and manual mode M/S



Press the selector lever from gear position D to the left to activate the Sport program.

### Sport program

This position is recommended for a performance-oriented driving style.

The gear position and the engaged gear are displayed in the instrument cluster, for instance S1.

### Manual mode

When you press the selector lever forward or backward, or when you pull one of the shift paddles, manual mode is activated and the gear is changed.

The gear position and the engaged gear are displayed in the instrument cluster, for instance M1.

The transmission provides assistance in the following situations:

- ▶ Upshifts and downshifts are executed only when they will result in a plausible combination of engine and vehicle speed; thus, for example, a downshift that would cause the engine to overrev will not be executed by the system.
- ▶ When the vehicle stops, the transmission automatically shifts down to first gear.
- ▶ Shortly before the vehicle slows down to below the minimum speed of the gear currently engaged, the transmission automatically shifts down without requiring your intervention.

Shifting down rapidly: even in manual mode, you can skip several gears to achieve optimal acceleration. Do so by pressing the accelerator past the resistance point.

### Changing to drive mode

Push the selector lever to the right.

### Shifting gears via the selector lever

In manual mode:

- ▶ To shift up, pull back the selector lever.
- ▶ To shift down, push it forward.

### Shifting gears using the shift paddles on the steering wheel

The shift paddles allow you to shift gears without taking your hands off the steering wheel. You do not need to raise your foot from the accelerator when doing so.

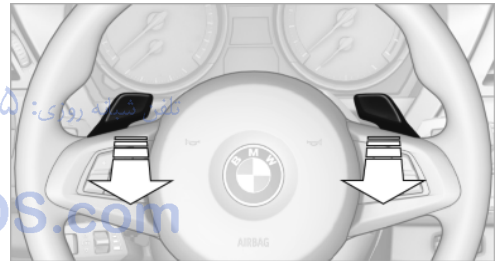

- ▶ Shift up: pull right shift paddle.
- ▶ Shift down: pull left shift paddle.

Gears can be shifted using the shift paddles in drive mode or in manual mode.

### Gear change in manual mode

When manual mode is active, refer to page 57, gears can be changed using the shift paddles or the selector lever.

### Gear change in drive mode

The shift paddles can be used to change gears in drive mode as well.

Afterwards, if the shift paddles are not used for some time and vehicle acceleration is insuffi-

cient, the forward gears are changed again automatically.

## Launch Control

Launch Control enables you to drive off with an optimal vehicle acceleration on a high grip road surface.

 Do not use Launch Control too often

Do not use Launch Control too often, as the higher loads on the vehicle lead to premature component wear. ◀

Launch Control is available when the engine is at operating temperature, i.e., after driving continuously for at least 6 miles/10 km.

1. With the engine running, depress the brake pedal with your left foot.
2. Activate the SPORT+ program of the Dynamic Driving Control, refer to page 82.
3. With the vehicle stationary, activate manual mode and select first gear.
4. Press the accelerator all the way down. The engine speed when driving off is controlled. A flag symbol appears in the instrument cluster.
5. The vehicle accelerates when you release the brake pedal. Keep the accelerator pressed all the way down.
6. The transmission shifts up automatically as long as the accelerator is pressed all the way down.

Launch Control only becomes available again after a certain distance has been driven.

Launch Control can only be used after the break-in phase, refer to page 108.

To maintain driving stability, activate DSC whenever possible.

## Manually releasing and engaging the transmission lock

If a power failure occurs, e.g., if the battery is discharged or disconnected, the transmission lock must be released manually, otherwise the

rear wheels are blocked and the vehicle cannot be towed.

Release the transmission lock manually for towing only and set the parking brake beforehand to prevent the vehicle from rolling. After parking the vehicle, engage the transmission lock again manually, refer to page 59.

## Manual release

1. Unclip the sleeve of the selector lever.
2. Pull the sleeve up over the selector lever until the sleeve is inside out.



3. Unclip and raise cover frame.
4. Insert an Allen wrench of the right size into the cap.

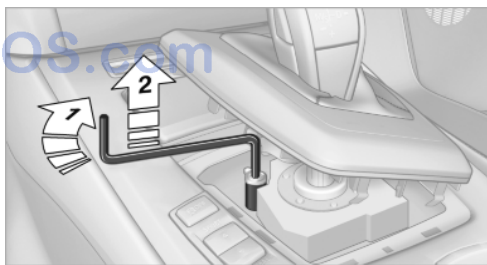

5. Turn the cap with the Allen wrench, arrow 1, and remove it, arrow 2.
6. Insert the Allen wrench into the opening, arrow 1.

 Turn the Allen wrench in the correct direction

Do not turn the Allen wrench in the opposite direction as this may damage the mechanism. ◀

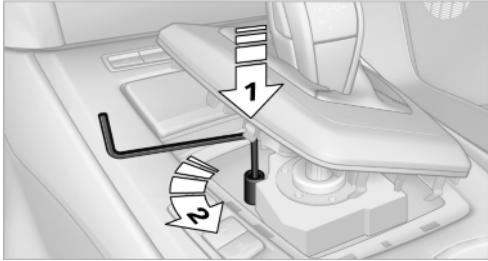

7. Turn the Allen wrench as far as it will go, arrow 2. The transmission lock is released.
8. Draw the Allen wrench out of the opening.

 Locking the transmission lock again  
After parking the vehicle, lock the transmission lock again to prevent the vehicle from rolling. ◀

### Locking manually

1. Press the button, see arrow. The transmission lock is locked again.

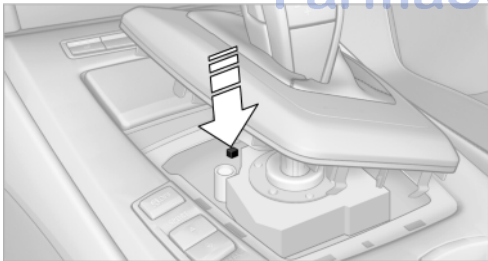

2. Clip the cover frame back into place.
3. Clip the sleeve of the selector lever back in place.
4. Set the parking brake.

Jump-starting, refer to page 177, towing, refer to page 179.

# Displays

## Vehicle equipment

This chapter describes all series equipment as well as country-specific and special equipment offered for this model series. Therefore, it also describes equipment that may not be found in your vehicle, for instance due to the selected special equipment or the country version. This also applies to safety-related functions and systems.

## Odometer, outside temperature display, clock

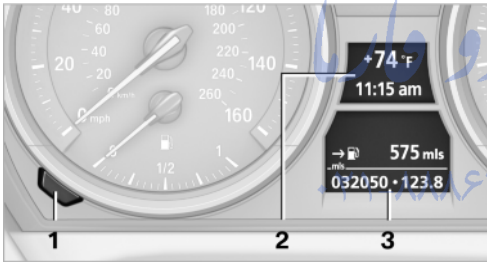

- 1 Knob in the instrument cluster
- 2 Outside temperature display and clock
- 3 Odometer and trip odometer

### Knob in the instrument cluster

- ▷ To reset the trip odometer while the ignition is switched on.
- ▷ To display the time, external temperature and odometer briefly while the ignition is switched off.

### Units of measure

To set the respective units of measure, miles or km for the odometer and °C or °F for the external temperature, refer to page 63.

The setting is stored for the remote control currently in use.

### Time, outside temperature display

Set the time, refer to page 64.

### External temperature warning

If the display drops to 37 °F/3 °C, a signal sounds and a warning lamp lights up. There is the increased danger of ice.



Ice on roads

Even at temperatures above +37 °F/+3 °C, there can be a risk of ice on roads.

Therefore, drive carefully on bridges and shady roads, for example, to avoid the increased danger of an accident. ◀

### Odometer and trip odometer

Resetting trip odometer:

With the ignition switched on, press button 1 in the instrument cluster.

### When the vehicle is parked

If you still want to view the time, outside temperature and odometer reading briefly after the remote control has been taken out of the ignition lock:

Press button 1 in the instrument cluster.

## Tachometer



Never force the engine speed up into the red warning field, see arrow. In this range, the fuel supply is interrupted to protect the engine.

## Coolant temperature

A warning lamp will come on if the coolant, and therefore the engine, becomes too hot.

Check the coolant level, refer to page 167.

## Engine oil temperature



- ▷ Cold engine: the pointer is at the low temperature end. Drive at moderate engine and vehicle speeds.
- ▷ Normal operating temperature: the pointer is in the middle of the temperature display.
- ▷ Hot engine: the pointer is at the high temperature end. Switch off the engine immediately and allow it to cool down.

If the engine oil temperature is too high, a warning lamp comes on in the instrument cluster.

Check the oil level, refer to page 164.

## Fuel gauge



The vehicle inclination may cause the display to vary.

Notes on refueling, refer to page 152.

## Range

After the reserve range is reached:

- ▷ An indicator lamp is briefly displayed.

- ▷ The remaining range is shown on the computer.
- ▷ When a dynamic driving style is used, such as when corners are taken rapidly, engine functions are not ensured.

Below a range of approx. 30 miles/50 km, the indicator lamp is displayed continuously.



#### Refuel promptly

At the latest, refuel at a range of 30 miles/50 km; otherwise, the engine function is not ensured and damage may occur. ◀

## Computer

### Displays in the instrument cluster

#### Calling up information

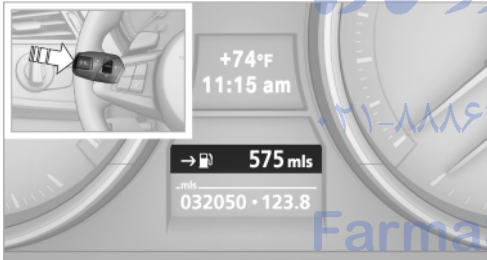

Press the button in the turn indicator lever.

The following items of information are displayed in the order listed:

- ▷ Range.
- ▷ Average speed.
- ▷ Average fuel consumption.
- ▷ Current fuel consumption.

## Settings and information

### Operating concept

Certain settings and information can only be called up when the ignition is switched on. A

- ▷ No information.

To set the corresponding units of measure, formats and units of measure, refer to page 63.

### Range

Displays the estimated cruising range available with the remaining fuel. The range is calculated based on your driving style over the last 18 miles/30 km and the current fuel supply.

### Average speed

Periods in which the vehicle was parked and the engine was switched off manually are not included in the average speed calculations.

To reset the average speed: press the button on the turn indicator lever for approx. 2 seconds.

### Average fuel consumption

The average fuel consumption is calculated for the time during which the engine is running.

To reset the average consumption: press the button on the turn indicator lever for approx. 2 seconds.

### Current fuel consumption

Displays the current fuel consumption. This allows you to see whether your current driving style is conducive to fuel economy with minimum exhaust emissions.

### Professional Radio: displays on the radio display

Some computer functions can also be shown, refer to page 119, on the radio display.

number of settings cannot be made while driving.

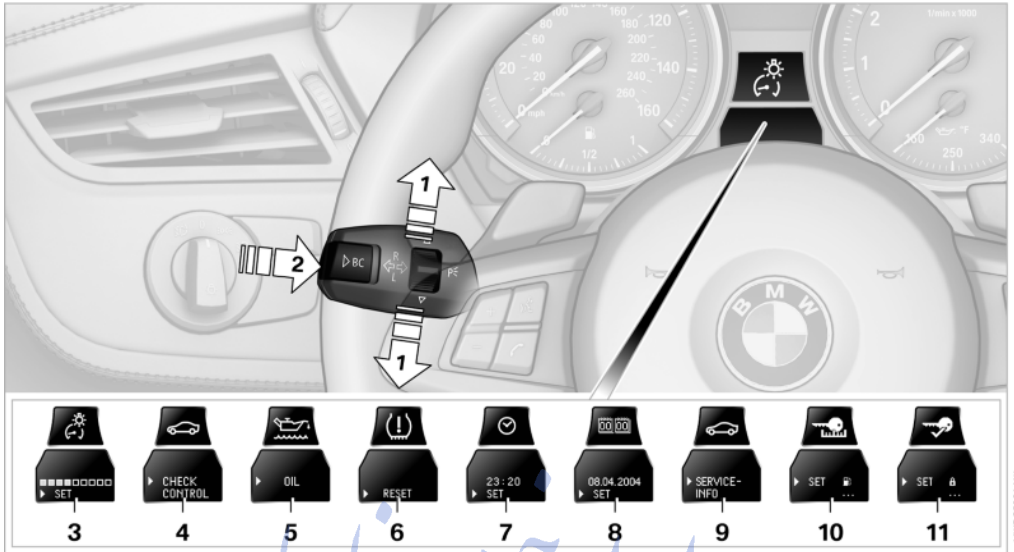

- 1 Button for:
  - ▶ Selecting the display
  - ▶ Setting values
- 2 Button for:
  - ▶ Confirming selected display or set values
  - ▶ Calling up computer information [62](#)
- 3 With the lights switched on: dimming the instrument lighting [71](#)
- 4 Calling up Check Control [66](#)
- 5 Checking the engine oil level [164](#)
- 6 Initializing the Flat Tire Monitor [76](#)  
Resetting the Tire Pressure Monitor [77](#).
- 7 Setting the time [64](#)
- 8 Setting the date [65](#)
- 9 Viewing service requirement display [65](#)
- 10 Setting formats and units of measure, re-setting to factory settings [63](#)
- 11 Changing settings
  - ▶ Confirmation signals when locking and unlocking the vehicle [24](#)
  - ▶ Response during unlocking procedure [22](#)
  - ▶ Automatic locking [26](#)
  - ▶ Headlamp courtesy delay feature [68](#)
  - ▶ Daytime running lights [69](#)
  - ▶ Triple turn signal activation [50](#)
  - ▶ Seat memory [39](#)

## Exiting displays

The external temperature reading and the time reappear when you press button 2 or if you make no entries within approx. 15 seconds. If required, complete the current setting first.

## Formats and units of measure

You can set formats and units of measure.

1. Switch on the ignition, refer to page [45](#).
2. Lightly push button 1 in the turn indicator lever up or down repeatedly until the symbol



appears in the display, accompanied by the word "SET".

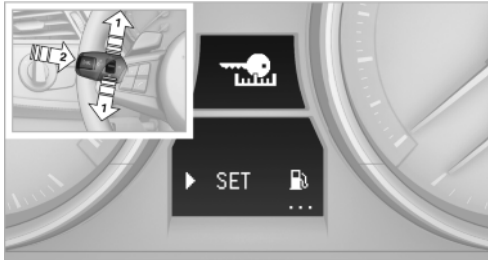

MV10036CMA

3. Press button 2.
4. Use button 1 to select desired format or desired unit of measure, e.g., for fuel consumption.
  - ▷ Fuel consumption: l/100 km, mpg, km/l
  - ▷ Distance: km, mls
  - ▷ Time: 12h, 24h
  - ▷ Date: day.month dd.mm, month/day mm/dd
  - ▷ Temperature: °C, °F

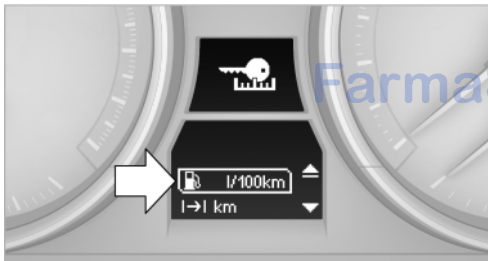

MM09107CMA

5. Press button 2.
6. Use button 1 to make the setting.
7. Press button 2. The setting is stored for the remote control currently in use.

### Resetting to factory settings

You can reset the settings for formats and units of measure to factory settings.

1. Lightly push button 1 in the turn indicator lever up or down repeatedly until the symbol

appears in the display, accompanied by the word "SET".

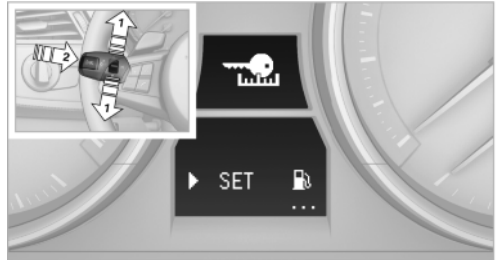

MV10036CMA

2. Press button 2.
3. Use button 1 to select "RESET".

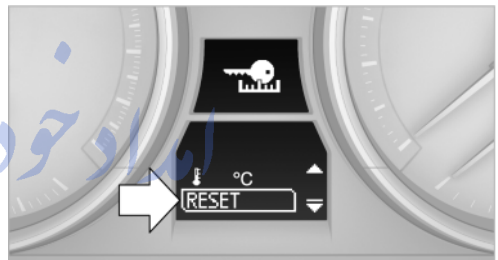

MM09110CMA

4. Press button 2 until is displayed. The settings are reset. The setting is stored for the remote control currently in use.

## Clock

### Setting the time

To set the 12h/24h format, Formats and units of measure, refer to page 63.

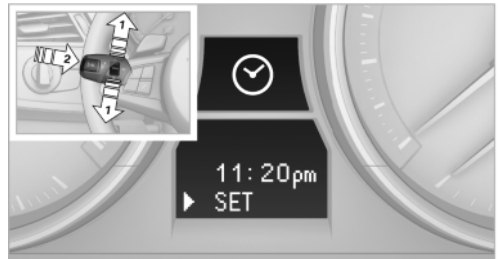

MV10036CMA

1. Press button 1 in the turn indicator lever up or down repeatedly until the appropriate



symbol appears in the display, accompanied by the time and the word "SET".

2. Press button 2.
3. Use button 1 to set the hours.
4. Press button 2 to confirm the entry.
5. Use button 1 to set the minutes.
6. Press button 2 to confirm the entry.
7. Press button 2.

The system accepts the new time.

## Date

### Setting the date

To set the dd/mm or mm/dd date format, formats and units of measure, refer to page 63.

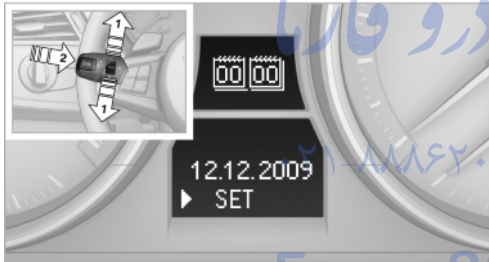

1. Push button 1 in the turn indicator lever up or down repeatedly until the appropriate symbol appears in the display, accompanied by the date and the word "SET".
2. Press button 2.
3. Use button 1 to set the day of the month.
4. Press button 2 to confirm the entry.
5. Set the month and the year in the same way.
6. Press button 2.

The system stores the new date.

## Service requirements

### Display

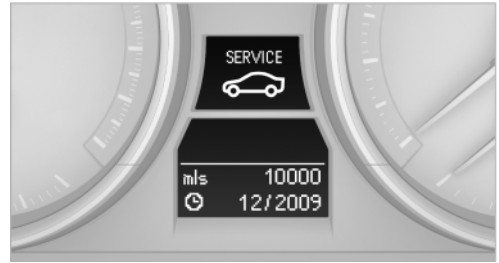

The remaining driving distance and the date of the next maintenance are displayed briefly after the ignition is switched on.

The current service requirements can be read out from the remote control by the service specialist.

The remaining driving distance or the due date can be displayed individually for certain maintenance procedures.

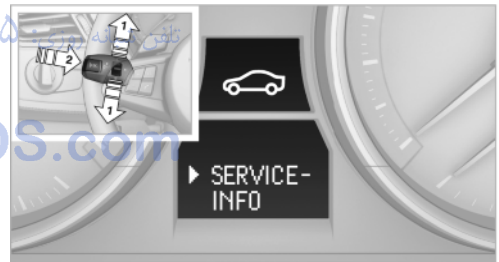

1. Switch on the ignition.
2. Press button 1 in the turn indicator lever up or down repeatedly until the appropriate symbol appears in the display, accompanied by the words "SERVICE INFO".
3. Press button 2.
4. Use button 1 to scroll through the individual service items.

## Possible displays

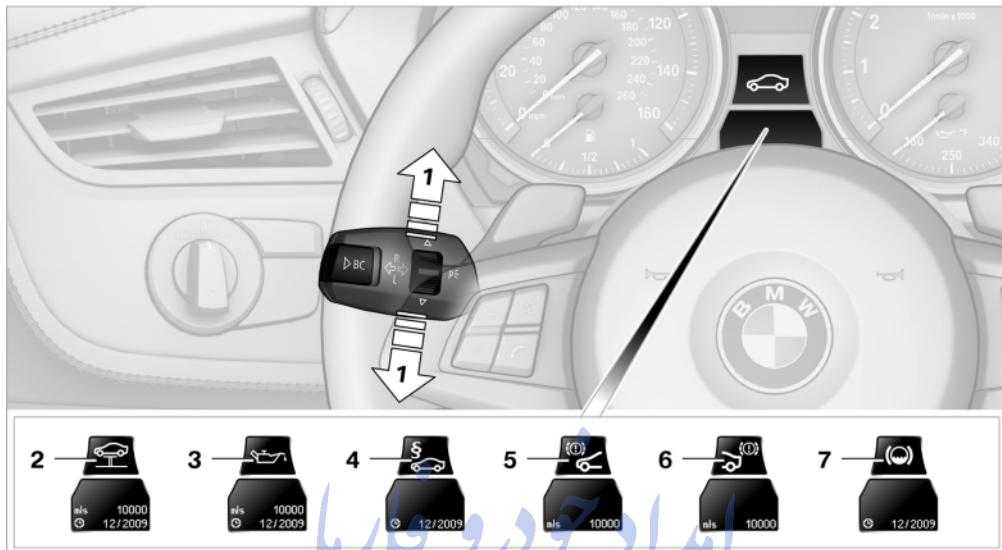

- |                                  |                    |
|----------------------------------|--------------------|
| 1 Button for selecting functions | 5 Front brake pads |
| 2 Service requirements           | 6 Rear brake pads  |
| 3 Engine oil                     | 7 Brake fluid      |
| 4 Roadworthiness test            |                    |

The sequence of displayed service items may vary. The data for the next service appointment is shown first.

## Check Control

### The concept

The Check Control monitors vehicle functions and alerts you to any malfunctions in the systems monitored.

Such Check Control messages involve indicator or warning lamps in the instrument cluster and, in some circumstances, an acoustic signal.



The indicator and warning lamps can light up in a variety of combinations and colors.



△ indicates that Check Control messages have been stored. You can view the Check Control messages whenever it is convenient for you.

### What to do in case of a malfunction

The meaning of each lamp in the event of a malfunction and tips on how to respond are provided in the list, refer to page 186.

### Hiding Check Control messages

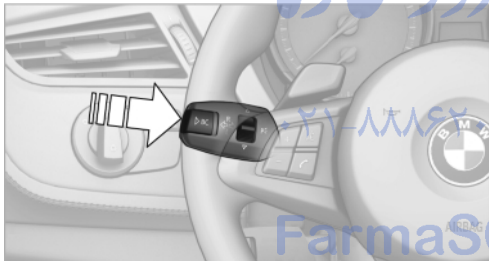

Press the button in the turn indicator lever.

Some Check Control messages are displayed until the malfunctions have been rectified. They cannot be hidden. If several malfunctions occur at the same time, they are displayed in succession.

Other messages are automatically hidden after approx. 20 seconds, but are kept in memory.

### Viewing stored Check Control messages

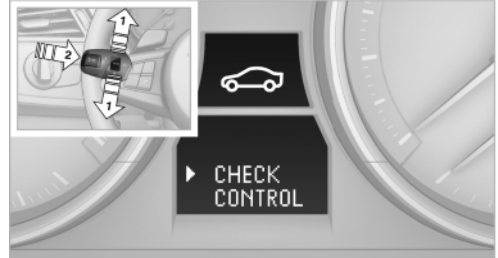

1. Press button 1 in the turn indicator lever up or down repeatedly until the appropriate symbol appears in the display, accompanied by the words "CHECK CONTROL".
2. Press button 2. If there is no Check Control message, this is indicated by "CHECK OK". If a Check Control message has been stored, the corresponding lamp comes on.
3. Press button 1 to check for other messages.
4. Press button 2.  
The display again shows the external temperature and the time.

### Messages after trip completion

Special messages that were displayed during a trip are displayed again after the ignition is switched off.

# Lamps

## Vehicle equipment

This chapter describes all series equipment as well as country-specific and special equipment offered for this model series. Therefore, it also describes equipment that may not be found in your vehicle, for instance due to the selected special equipment or the country version. This also applies to safety-related functions and systems.

## At a glance

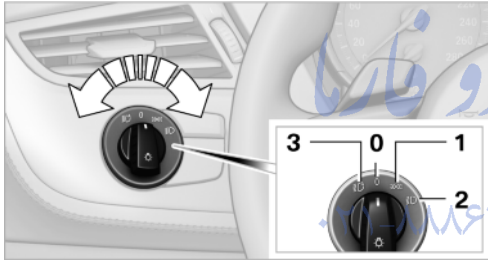

- 0 Lamps off  
Daytime running lights
- 1 Parking lamps and daytime running lights
- 2 Low-beam headlamps and welcome lamps
- 3 Automatic headlamp control, daytime running lights, welcome lamps, High-beam Assistant, and adaptive light control

When you open the driver's door with the ignition switched off, the exterior lighting is automatically switched off if the light switch is in position 0, 2, or 3.

Switch on the parking lamps if necessary, switch position 1.

## Parking lamps/low beams, headlamp control

### Parking lamps

Switch position : the vehicle lamps light up on all sides, e.g., for parking.

Do not use the parking lamps for extended periods; otherwise, the battery may become discharged and it would then be impossible to start the engine.

When parking, it is preferable to switch on the one-sided roadside parking lamps, refer to page 70.

### Low beams

Switch position with the ignition switched on: the low beams light up.

### Welcome lamps

When parking the vehicle, leave the switch in position or : the parking and interior lamps light up briefly when the vehicle is unlocked.

### Headlamp courtesy delay feature

The low beams stay lit for a short while after the ignition is switched off, if the lamps are switched off and the headlamp flasher is switched on.

### Setting the duration

Operating principle, refer to page 62.

1. Switch on the ignition.
2. Lightly push button 1 in the turn indicator lever up or down repeatedly until the symbol

appears in the display, accompanied by the word "SET".

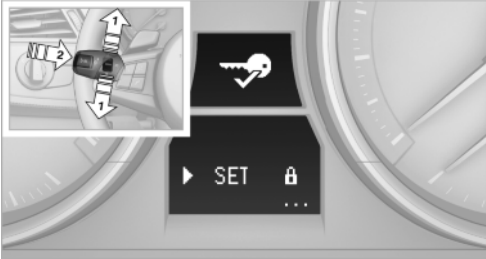

3. Press button 2.
4. Lightly push button 1 in the turn indicator lever down repeatedly until the symbol appears in the display.

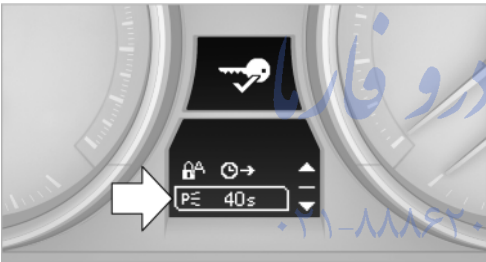

5. Press button 2.
6. Use button 1 to select one of the following:
  - ▷ **0 s** The function is deactivated.
  - ▷ **10 s ... 240 s** Select the corresponding duration, 40 seconds, for instance.

7. Press button 2.

The setting is stored for the remote control currently in use.

### Automatic headlamp control

Switch position : the low beams are switched on and off automatically, e.g., in tunnels, in twilight or if there is precipitation. The LED next to the symbol lights up.

A blue sky with the sun low on the horizon can cause the lights to be switched on.



### Personal responsibility

The automatic headlamp control cannot serve as a substitute for your personal judgment in determining when the lamps should be switched on in response to ambient lighting conditions.

For example, the sensors are unable to detect fog or hazy weather. To avoid safety risks, you should always switch on the lamps manually under these conditions. ◀

### Daytime running lights

The daytime running lights light up in position 0, and . After the ignition is switched off, the parking lamps light up in position .

### Activating/deactivating

Operating principle, refer to page 62.

1. Switch on the ignition.
2. Lightly push button 1 in the turn indicator lever up or down repeatedly until the symbol appears in the display, accompanied by the word "SET".

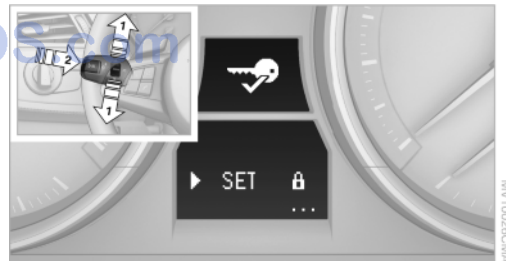

3. Press button 2.

- Lightly push button 1 in the turn indicator lever up or down repeatedly until the symbol appears in the display.

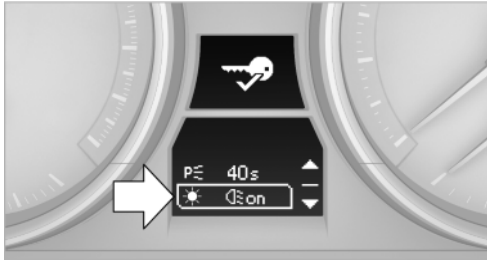

- Press button 2.
- Use button 1 to select one of the following:
  - ▶ Daytime running lights are activated.
  - ▶ Daytime running lights are deactivated.
- Press button 2.

The setting is stored for the remote control currently in use.

## Adaptive light control

### The concept

Adaptive light control is a variable headlamp control system that enables dynamic illumination of the road surface.

Depending on the steering angle and other parameters, the light from the headlamp follows the course of the road.

### Controls

#### Activating

Switch position with the ignition switched on.

Auxiliary function:

To avoid blinding oncoming traffic, the adaptive light control directs light towards the front passenger side when the vehicle is at a standstill.

### Malfunction

Adaptive light control is malfunctioning or has failed. Have the system checked as soon as possible.

## High beams/roadside parking lamps

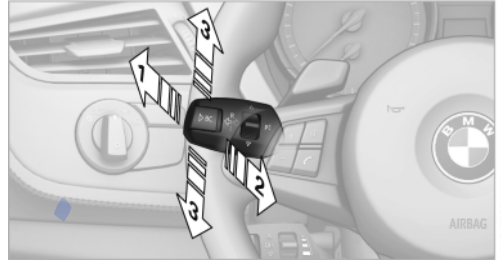

- High beams
- Headlamp flasher
- Roadside parking lamps

### Left and right roadside parking lamps

There is an additional option of switching on the lamps on the side of the car facing the road when parked.

#### Switching on

After parking the vehicle, press the lever up or down beyond the pressure point for a longer period, arrow 3.

The roadside parking lamps drain the battery. Therefore, do not leave them on for unduly long periods of time; otherwise, the battery might not have enough power to start the engine.

#### Switching off

Press the lever in the opposite direction to the pressure point, arrow 3.

## High-beam Assistant

### The concept

When the lights are switched on, this system automatically switches the high beams on and off. The procedure is controlled by a sensor on the front of the interior rearview mirror. The assistant ensures that the high beams are switched on whenever the traffic situation allows. The driver can intervene at any time and switch the high beams on and off as usual.

### Activating the High-beam Assistant

1. Turn the light switch to .
2. With the low beams switched on, briefly push the turn indicator lever in the direction of the high beam.



The indicator lamp in the instrument cluster lights up.

When the lights are switched on, the high beams are switched on and off automatically.

The system responds to light from oncoming traffic and traffic driving ahead of you, and to adequate illumination, e.g., in towns and cities.

### Switching the high beams on and off manually

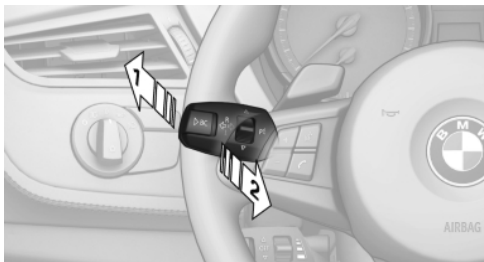

- ▶ High beams on, arrow 1.
- ▶ High beams off/headlamp flasher, arrow 2.

To reactivate the High-beam Assistant, briefly push the turn indicator lever toward the high beams.

### System limits



#### Personal responsibility

The High-beam Assistant cannot serve as a substitute for the driver's personal judgment of when to use the high beams. Therefore, manually switch off the high beams in situations where this is required to avoid a safety risk. ◀

The system is not fully functional in situations such as the following, and driver intervention may be necessary:

- ▶ In very unfavorable weather conditions, such as fog or heavy precipitation.
- ▶ In detecting poorly-lit road users, such as pedestrians, cyclists, horseback riders and wagons; when driving close to train or ship traffic; and at animal crossings.
- ▶ In tight curves, on hilltops or in depressions, in cross traffic or half-obscured oncoming traffic on freeways.
- ▶ In poorly-lit towns and cities and in the presence of highly reflective signs.
- ▶ At low speeds.
- ▶ When the windshield in front of the interior rearview mirror is fogged over, dirty or covered with stickers, etc.

### Sensor view field

The view field of the sensor is located on the front of the interior rearview mirror.

Do not cover this area with stickers, etc.

Clean the view field, refer to page 185.

### Instrument lighting

The parking lamps or low beams must be switched on to adjust the brightness.



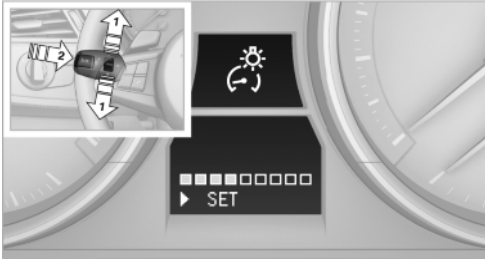

1. Push button 1 up or down repeatedly until the appropriate symbol appears in the display, accompanied by the brightness setting and the word "SET".
2. Press button 2.

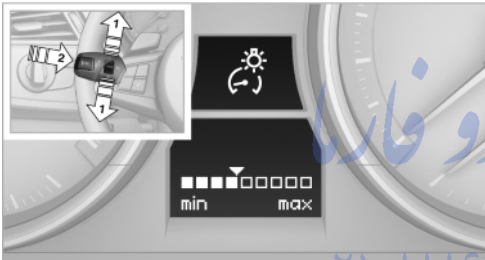

3. Push button 1 up or down to select the desired brightness level.
4. Press button 2.  
The display again shows the outside temperature and the time.

## Interior lamps

The interior lamps, footwell lamps, entry lamps, trunk lamp, and courtesy lamps are controlled automatically.

The LEDs for the courtesy lamps are set in the door handles and illuminate the ground in front of the doors.

To avoid draining the battery, all lamps inside the car are switched off about 8 minutes after the ignition is switched off, Start/Stop button, refer to page 45.

## Switching interior lamps on/off manually

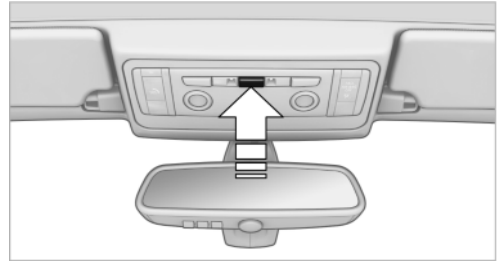

Interior lamps:

To switch on and off, press the button.

To switch off the interior lamps, footwell lamps, entry lamps, and courtesy lamps permanently, press the button for the front interior lamps for about 3 seconds.

## Reading lamps

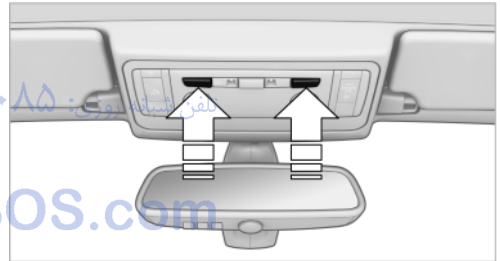

The reading lamps are located next to the interior lamp. To switch on and off, press the button.



# Safety

## Vehicle equipment

This chapter describes all series equipment as well as country-specific and special equipment offered for this model series. Therefore, it also describes equipment that may not be found in your vehicle, for instance due to the selected special equipment or the country version. This also applies to safety-related functions and systems.

## Airbags

The following airbags are located under the marked covers:

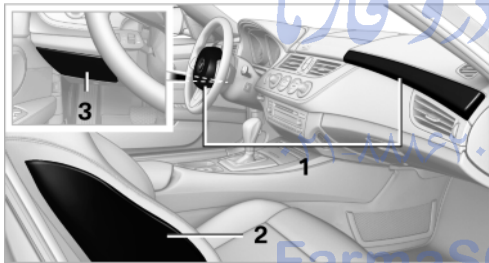

- 1 Front airbags
- 2 Side airbags in the seat backrests
- 3 Knee airbag

### Front airbags

Front airbags help protect the driver and passenger by responding to frontal impacts in which safety belts alone cannot provide adequate restraint.

### Side airbags

In a lateral impact, the side airbag protects the side of the body in the chest area.

### Knee airbag

The knee airbag supports the legs in a frontal impact.

### Protective action

Airbags are not triggered in every impact situation, e.g., in less severe accidents or rear-end collisions.

Even when all instructions are followed closely, injury from contact with the airbags cannot be ruled out in certain situations.

The ignition and inflation noise may lead to short-term and, in most cases, temporary hearing impairment in sensitive individuals.

 Information on how to ensure the optimal protective effect of the airbags

- ▶ Keep at a distance from the airbags.
- ▶ Always grasp the steering wheel on the steering wheel rim, holding your hands at the 3 o'clock and 9 o'clock positions, to keep the danger of injury to your hands or arms as low as possible if the airbag is triggered.
- ▶ There should be no people, animals, or objects between an airbag and a person.
- ▶ Do not use the cover of the front airbag on the front passenger side as a storage area.
- ▶ Keep the dashboard and window on the front passenger side clear, i.e., do not cover with adhesive labels or coverings, and do not attach holders such as for navigation instruments and mobile phones.
- ▶ Make sure that the front passenger is sitting correctly, i.e., keeps his or her feet and legs in the footwell; otherwise, leg injuries can occur if the front airbag is triggered.
- ▶ Do not place slip covers, seat cushions or other objects on the front passenger seat that are not approved specifically for seats with integrated side airbags.

- ▷ Do not hang pieces of clothing, such as jackets, over the backrests.
- ▷ Make sure that passengers do not lean their heads against the side airbag; otherwise, serious injuries could result if the airbag suddenly deployed.
- ▷ Do not remove the airbag restraint system.
- ▷ Do not remove the steering wheel.
- ▷ Do not apply adhesive materials to the airbag cover panels, cover them or modify them in any way.
- ▷ Never modify either the individual components or the wiring in the airbag system. This also applies to the covers of the steering wheel, the dashboard and the seats. ◀

**!** In the case of a malfunction, deactivation and after triggering of the airbags

Do not touch the individual components immediately after the system has been triggered; otherwise, there is the danger of burns.

Only have the airbags checked, repaired or dismantled and the airbag generator scrapped by your service center or a workshop that has the necessary authorization for handling explosives.

Non-professional attempts to service the system could lead to failure in an emergency or undesired triggering of the airbag, either of which could result in injury. ◀

Warning notices and information about the airbags can also be found on the sun visors.

### Automatic deactivation of the passenger airbags

The system determines whether the front passenger seat is occupied by measuring the resistance of the human body. The front and side airbags on the front passenger side are activated or deactivated accordingly by the system.

The indicator lamp above the interior rearview mirror shows the current status of the passenger airbags, deactivated or activated, refer to Status of passenger airbags below.



Passenger feet in the footwell

Make sure that the front passenger keeps his or her feet in the footwell; otherwise, the front passenger airbags may not function properly. ◀



Child restraint fixing system in the front passenger seat

Before transporting a child on the passenger seat, read the safety and operating instructions under Transporting children safely, refer to page 43. ◀

### Malfunction of the automatic deactivation system

The front passenger airbags may be deactivated if adolescents and adults sit in certain positions; the indicator lamp for the front passenger airbags comes on. In this case, change the sitting position so that the front passenger airbags are activated and the indicator lamp goes out. If the desired airbag status cannot be achieved by changing the sitting position, do not transport the passenger in the vehicle.

To make sure that occupation of the seat cushion can be detected correctly:

- ▷ Do not attach seat covers, seat cushion padding, ball mats or other items to the passenger seat unless they are specifically recommended by BMW.
- ▷ Do not place any objects on the front passenger seat.
- ▷ Do not place objects under the seat that could press against the seat from below.

### Status of passenger airbags



The indicator lamp for the front passenger airbags indicates the operating status of the front and side airbags on the front passenger side depending on the seat occupation. The indicator lamp shows whether the passenger airbags are activated or deactivated.

- ▶ The indicator lamp lights up when a child who is properly seated in a child restraint system intended for that purpose is detected on the seat or the seat is empty. The front and side airbags on the front passenger side are not activated. Most child seats are detected by the system, Especially the child seats required by NHTSA at the time that the vehicle was manufactured. After installing a child seat, make sure that the indicator lamp for the front passenger airbags lights up. This indicates that the child seat has been detected and the front passenger airbags are not activated.
- ▶ The indicator lamp does not light up when, for example, a person of sufficient size and in a correct sitting position is detected on the seat. The front and front passenger airbags on the front passenger side are activated.

## Operational readiness of airbag system



When the ignition, refer to page 46, is switched on, the warning lamp comes on briefly to indicate that the entire airbag system and the belt tensioners are operational.

## Airbag system malfunction

- ▶ The warning lamp does not light up when the ignition is switched on.
- ▶ Warning lamp remains permanently on.



Have the airbag system checked without delay if there is a malfunction

In the event of a malfunction in the airbag system, have it checked without delay; otherwise, there is the risk that the system will not function as intended even if a sufficiently severe accident occurs. ◀

## Flat Tire Monitor FTM

### The concept

The system detects a pressure loss in a tire on the basis of speed differences between the individual wheels during a trip.

In the event of pressure loss, the rolling circumference changes and, thus, the rotating speed of the affected wheel. This change is detected and is reported as a flat tire.

### Functional requirements

The system must have been initialized when the tire inflation pressure was correct; otherwise, reliable signaling of a flat tire is not ensured. Initialize the system after each correction of the tire inflation pressure and after every tire or wheel change.

### System limits



Sudden tire damage

Sudden serious tire damage caused by external influences cannot be indicated in advance. ◀

A natural, even pressure loss in all four tires cannot be detected.

The system could be delayed or malfunction in the following situations:

- ▶ When the system has not been initialized.

- ▶ When driving on a snowy or slippery road surface.
- ▶ Sporty driving style: slip in the drive wheels, high lateral acceleration.
- ▶ When driving with snow chains.

## Initialization

The initialization process adopts the set inflation tire pressures as reference values for the detection of a flat tire. Initialization is started by confirming the inflation pressures.

Do not initialize the system when driving with snow chains.

Operating principle, refer to page 62.

1. Start the engine immediately before pulling away, but do not drive off yet.
2. Lightly push button 1 in the turn indicator lever up or down repeatedly until the appropriate symbol appears in the display, accompanied by the word "RESET".

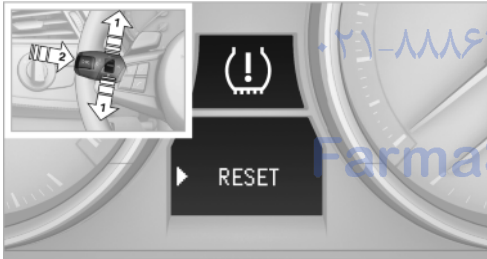

3. Press button 2 to confirm your choice of the Flat Tire Monitor.

4. Press button 2 for approx. 5 seconds until the display appears:

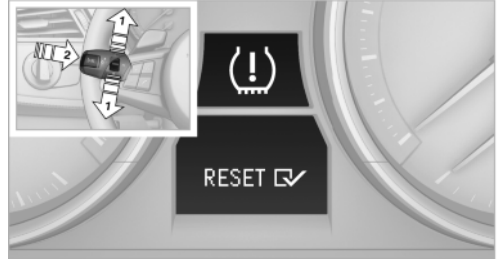

5. Drive away.

Initialization is completed while the car is on the move without providing feedback.

## Indication of a flat tire



The warning lamps come on in yellow and red. In addition, a signal sounds.



There is a flat tire or a major loss in tire inflation pressure.

1. Reduce your speed and stop cautiously. Avoid sudden braking and steering maneuvers. *تلفن شبانه روزی: ۰۸۵-۸۸۶۲۰۸۱*
2. Check whether the vehicle is fitted with regular tires or run-flat tires. Run-flat tires, refer to page 161, are labeled with a circular symbol containing the letters RSC marked on the tire sidewall.



Do not continue driving without run-flat tires

Do not continue driving if the vehicle is not equipped with run-flat tires; continued driving may result in serious accidents. ◀

When a flat tire is indicated, DSC Dynamic Stability Control is switched on if necessary.

## Actions in the event of a flat tire

### Normal tires

1. Identify the damaged tire.

Do this by checking the air pressure in all four tires.

If the tire inflation pressure in all four tires is correct, the Flat Tire Monitor may not have been initialized. In this case, initialize the system.

If an identification is not possible, please contact the service center.

2. Rectify the flat tire.

## Run-flat tires

You can continue driving with a damaged tire at speeds up to 50 mph/80 km/h.

### Continued driving with a flat tire

If continuing to drive with a damaged tire:

1. Avoid sudden braking and steering maneuvers.
2. Do not exceed a speed of 50 mph/80 km/h.
3. Check the air pressure in all four tires at the next opportunity.

If the tire inflation pressure in all four tires is correct, the Flat Tire Monitor may not have been initialized. In this case, initialize the system.

Possible driving distance with complete loss of tire inflation pressure:

The possible driving distance after a loss of tire inflation pressure depends on the cargo load and the driving style and conditions.

For a vehicle containing an average load, the possible driving distance is approx. 50 miles/ 80 km.

When the vehicle is driven with a damaged tire, its handling characteristics change, e.g., reduced lane stability during braking, a longer braking distance, and altered self-steering properties. Adjust your driving style accordingly. Avoid abrupt steering maneuvers or driving over obstacles, e. g., curbs, potholes, etc.

Because the possible driving distance depends on how the vehicle is used during the trip, the actual distance may be smaller or greater depending on the driving speed, road conditions, external temperature, cargo load, etc.



### Continued driving with a flat tire

Drive moderately and do not exceed a speed of 50 mph/80 km/h.

A loss of tire inflation pressure results in a change in the handling characteristics, e.g., reduced lane stability during braking, a longer braking distance and altered self-steering properties. ◀



### Final tire failure

Vibrations or loud noises while driving can indicate the final failure of the tire. Reduce speed and stop; otherwise, pieces of the tire could come loose and cause an accident. Do not continue driving, and contact your service center. ◀

## Tire Pressure Monitor TPM

### The concept

TPM checks the inflation pressures of the four mounted tires. The system notifies you if there is a significant loss of pressure in one or more tires. تلفن شبانه ۰۸۰۰۰۰۰۰۰۰۰۰۰۰

### Functional requirement

In order to assure the reliable reporting of a flat tire, the system must be reset while all tire inflation pressures are correct.

Always use wheels with TPM electronics. Otherwise, the system may malfunction.

Reset the system after each correction of the tire inflation pressure and after every tire or wheel change.

### System limits



### Sudden tire damage

Sudden serious tire damage caused by external influences cannot be indicated in advance. ◀

The system does not function properly if it has not been reset, e.g., it may identify a tire as flat

in spite of the fact that the tire is filled to the correct inflation pressure.

The system is deactivated and is unable to detect flat tires if a wheel not equipped with TPM electronics has been mounted, e.g., a compact wheel, or if TPM is experiencing temporary interference from other systems or devices that use the same frequency.

### Resetting the system

Reset the system after each correction of the tire inflation pressure and after every tire or wheel change.

Operating principle, refer to page 62.

1. Start the engine, but do not start driving.
2. Lightly push button 1 in the turn indicator lever up or down repeatedly until the appropriate symbol appears in the display, accompanied by the word "RESET".



3. Press button 2 to confirm your choice of the Tire Pressure Monitor.

The following display appears:



4. Press button 2 for approx. 5 seconds until the small warning lamp lights up yellow and the following display appears:



5. Drive away.

After driving a few minutes, the set inflation pressures in the tires are accepted as the target values to be monitored. The system reset is completed during your drive, and can be interrupted at any time. When driving resumes, the reset is continued automatically. The indicator lamp goes out after the system reset is completed.

### Low tire pressure message

The warning lamps come on in yellow and red. In addition, a signal sounds.



- There is a flat tire or a major loss in tire inflation pressure.
- The system was not reset after a wheel change and thus issues warnings based on the inflation pressures initialized last.

1. Reduce your speed and stop cautiously. Avoid sudden braking and steering maneuvers.
2. Check whether the vehicle is fitted with regular tires or run-flat tires.

Run-flat tires, refer to page 160, are labeled with a circular symbol containing the letters RSC marked on the tire sidewall.



Do not continue driving without run-flat tires

Do not continue driving if the vehicle is not equipped with run-flat tires; continued driving may result in serious accidents. ◀

When a flat tire is indicated, DSC Dynamic Stability Control is switched on if necessary.

## Actions in the event of a flat tire

### Normal tires

#### 1. Identify the damaged tire.

Do this by checking the air pressure in all four tires.

If the tire inflation pressure in all four tires is correct, the Tire Pressure Monitor may not have been initialized. In this case, initialize the system.

If an identification is not possible, please contact the service center.

#### 2. Rectify the flat tire.

The use of tire sealant can damage the TPM electronics. In this case, have the electronics checked at the next opportunity and have them replaced if necessary.

### Run-flat tires

You can continue driving with a damaged tire at speeds up to 50 mph/80 km/h.

### Continued driving with a flat tire

If continuing to drive with a damaged tire:

1. Avoid sudden braking and steering maneuvers.
2. Do not exceed a speed of 50 mph/80 km/h.
3. Check the air pressure in all four tires at the next opportunity.

If the tire inflation pressure in all four tires is correct, the Tire Pressure Monitor may not have been initialized. In this case, initialize the system.

Possible driving distance with complete loss of tire inflation pressure:

The possible driving distance after a loss of tire inflation pressure depends on the cargo load and the driving style and conditions.

For a vehicle containing an average load, the possible driving distance is approx. 50 miles/80 km.

When the vehicle is driven with a damaged tire, its handling characteristics change, e.g., reduced lane stability during braking, a longer braking distance, and altered self-steering properties. Adjust your driving style accordingly. Avoid abrupt steering maneuvers or driving over obstacles, e. g., curbs, potholes, etc.

Because the possible driving distance depends on how the vehicle is used during the trip, the actual distance may be smaller or greater depending on the driving speed, road conditions, external temperature, cargo load, etc.



Continued driving with a flat tire

Drive moderately and do not exceed a speed of 50 mph/80 km/h.

A loss of tire inflation pressure results in a change in the handling characteristics, e.g., reduced lane stability during braking, a longer braking distance and altered self-steering properties. ◀



Final tire failure

Vibrations or loud noises while driving can indicate the final failure of the tire. Reduce speed and stop; otherwise, pieces of the tire could come loose and cause an accident. Do not continue driving, and contact your service center. ◀

### Malfunction



The small warning lamp flashes in yellow and then lights up continuously; the larger warning lamp comes on in yellow. No flat tire can be detected.

Display in the following situations:



- ▷ A wheel without TPM electronics is fitted: have the service center check it if necessary.
- ▷ Malfunction: have the system checked by your service center.
- ▷ TPM could not be fully reset. Reset the system again.

(!)



The small warning lamp flashes in yellow and then lights up continuously; the larger warning lamp comes on in yellow. No flat tire can be detected.

Display in the following situations:

- ▷ Disturbance by systems or devices with the same radio frequency. After leaving the area of the disturbance, the system automatically becomes active again.

## Declaration according to NHTSA/ FMVSS 138 Tire Pressure Monitoring Systems

Each tire, including the spare (if provided) should be checked monthly when cold and inflated to the inflation pressure recommended by the vehicle manufacturer on the vehicle placard or tire inflation pressure label (If your vehicle has tires of a different size than the size indicated on the vehicle placard or tire inflation pressure label, you should determine the proper tire inflation pressure for those tires.).

As an added safety feature, your vehicle has been equipped with a tire pressure monitoring system (TPMS) that illuminates a low tire pressure telltale when one or more of your tires is significantly under-inflated. Accordingly, when the low tire pressure telltale illuminates, you should stop and check your tires as soon as possible, and inflate them to the proper pressure. Driving on a significantly under-inflated tire causes the tire to overheat and can lead to tire failure. Under-inflation also reduces fuel efficiency and tire tread life, and may affect the vehicle's handling and stopping ability.

Please note that the TPMS is not a substitute for proper tire maintenance, and it is the driver's responsibility to maintain correct tire pressure,

even if under-inflation has not reached the level to trigger illumination of the TPMS low tire pressure telltale.

Your vehicle has also been equipped with a TPMS malfunction indicator to indicate when the system is not operating properly. The TPMS malfunction indicator is combined with the low tire pressure telltale. When the system detects a malfunction, the telltale will flash for approximately one minute and then remain continuously illuminated. This sequence will continue upon subsequent vehicle start-ups as long as the malfunction exists. When the malfunction indicator is illuminated, the system may not be able to detect or signal low tire pressure as intended. TPMS malfunctions may occur for a variety of reasons, including the installation of replacement or alternate tires or wheels on the vehicle that prevent the TPMS from functioning properly. Always check the TPMS malfunction telltale after replacing one or more tires or wheels on your vehicle to ensure that the replacement or alternate tires and wheels allow the TPMS to continue to function properly.

## Brake force display

### The concept

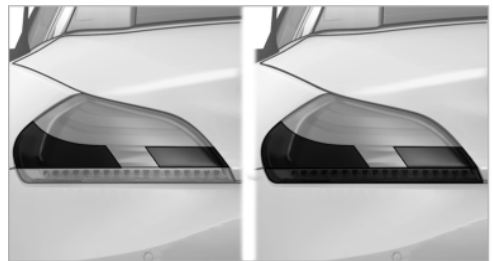

- ▷ During normal brake application, the brake lamps light up.
- ▷ During heavy brake application, the turn signals light up in addition.

The brake force display is not activated if the turn signal function is switched on.



# Driving stability control systems

## Vehicle equipment

This chapter describes all series equipment as well as country-specific and special equipment offered for this model series. Therefore, it also describes equipment that may not be found in your vehicle, for instance due to the selected special equipment or the country version. This also applies to safety-related functions and systems.

## Antilock Brake System ABS

ABS prevents locking of the wheels during braking.

The vehicle remains steerable even during full brake applications, thus increasing active safety.

ABS is operational every time you start the engine.

## Electronic brake-force distribution

The system controls the brake pressure in the rear wheels to ensure stable braking behavior.

## Dynamic Brake Control DBC

When you apply the brakes rapidly, this system automatically produces the maximum braking force boost. It thus helps to achieve the shortest possible braking distance during full braking. This system utilizes all of the benefits provided by ABS.

Do not reduce the pressure on the brake pedal for the duration of the full braking.

## Dynamic Stability Control DSC

### The concept

DSC prevents traction loss in the driving wheels when driving away and accelerating.

DSC also recognizes unstable vehicle conditions, such as fishtailing or nose-diving. Subject to physical limits, DSC helps to keep the vehicle on a steady course by reducing engine speed and by applying brakes to the individual wheels.



Adjust your driving style to the situation

An appropriate driving style is always the responsibility of the driver.

The laws of physics cannot be repealed, even with DSC.

Therefore, do not reduce the additional safety margin by driving in a risky manner. ◀

### Activating/deactivating DSC

DSC can be deactivated/activated via the DSC OFF program of the Dynamic Driving Control, refer to page 82.

### For better control



The DSC indicator lamp flashes: DSC is controlling the drive forces and brake forces.

The DSC indicator lamp lights up: DSC has failed.

## Dynamic Traction Control DTC

### The concept

The DTC system and the TRACTION program are a variant of the DSC in which forward momentum is optimized.

The system ensures maximum forward momentum on special road conditions, e.g., unplowed snowy roads, but driving stability is limited.

It is therefore necessary to drive with appropriate caution.

You may find it useful to briefly activate DTC under the following special circumstances:

- ▶ When driving in slush or on uncleared, snow-covered roads.
- ▶ When rocking the vehicle or driving off in deep snow or on loose surfaces.
- ▶ When driving with snow chains.

### Deactivating/activating Dynamic Traction Control DTC

The system and program can be deactivated/activated via Dynamic Driving Control, refer to page 83.

## Dynamic Driving Control



### The concept

Dynamic Driving Control can be used to adjust the driving dynamics of the vehicle. Several programs are available for this purpose; one program can be activated at a time using the Dynamic Driving Control buttons.

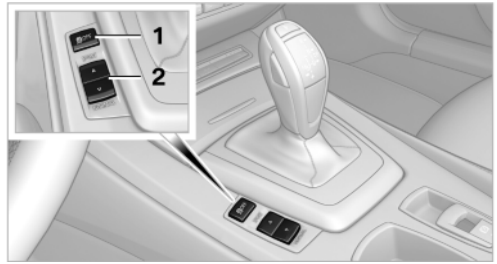
## Operating the programs



MM09219CMA

Press the button	Program
	DSC OFF TRACTION
	SPORT+ SPORT COMFORT

## DSC OFF



MM09124CMA

Driving stability is limited during acceleration and when driving in bends.

To increase vehicle stability, activate DSC again as soon as possible.

### Deactivating DSC: DSC OFF

 Press the button for no longer than approx. 10 seconds until the indicator lamp for DSC OFF lights up in the instrument cluster and DSC OFF appears in the instrument cluster.

The DSC system is switched off.

## Activating DSC



Press the button.

DSC OFF and the DSC OFF indicator lamp go out.

## Indicator/warning lamps

When DSC is deactivated, DSC OFF is displayed in the instrument cluster.



The DSC OFF indicator lamp lights up: DSC is deactivated.

## TRACTION

Maximum traction on loose road surfaces. Dynamic Traction Control DTC is switched on. Driving stability is limited during acceleration and when driving in bends.

## Activating TRACTION



Press the button.

TRACTION is displayed in the instrument cluster.

The DSC OFF indicator lamp lights up in the instrument cluster.

## Deactivating TRACTION



Press the button again.

TRACTION and the DSC OFF indicator lamp go out.

## Indicator/warning lamps

When DTC is activated, TRACTION is displayed in the instrument cluster.



The DSC OFF indicator lamp lights up: Dynamic Traction Control DTC is activated.

## SPORT+



Sporty driving with optimized chassis and suspension during limited driving stabilization.

Dynamic Traction Control is switched on.

The driver handles several of the stabilization tasks.

## Activating SPORT+



Press the button repeatedly until SPORT+  is selected in the instrument cluster and the DSC OFF indicator lamp is displayed.

## Indicator/warning lamps

SPORT+ is displayed in the instrument cluster.



The DSC OFF indicator lamp lights up: Dynamic Traction Control DTC is activated.

## SPORT

Consistently sporty tuning of the suspension for greater driving agility with maximum driving stabilization.

## Activating SPORT



Press the button repeatedly until SPORT is selected in the instrument cluster.

## COMFORT

For a balanced tuning with maximum driving stabilization.

## Activating COMFORT



Press the button repeatedly until COMFORT is selected in the instrument cluster.

## Displays in the instrument cluster



The selected program is displayed in the instrument cluster.

## Drive-off assistant

This system supports driving away on gradients.

The parking brake is not required. تلفن شبانه روزی: ۰۸۵-۸۸۸۶۲۰۱

1. Hold the vehicle in place with the foot brake.
2. Release the foot brake and drive away without delay.

After the foot brake is released, the vehicle is held in place for approx. 2 seconds.

Depending on the vehicle load, the vehicle may roll back slightly.



### Driving off without delay

After releasing the foot brake, start driving without delay, since the drive-off assistant will not hold the vehicle in place for more than approx. 2 seconds and the vehicle will begin rolling back. ◀

## Servotronic

### The concept

The Servotronic varies the steering force required to turn the wheels depending on the speed at which you are driving. Power steering provides strong support at low speeds, which means that little effort is needed to turn the wheels. Power steering support lessens as your speed increases.

The system works automatically.

### Malfunction

Malfunctions are displayed via Check Control, refer to page 186.

امداد خودرو فارما

FarmaSOS.com

# Driving comfort

## Vehicle equipment

This chapter describes all series equipment as well as country-specific and special equipment offered for this model series. Therefore, it also describes equipment that may not be found in your vehicle, for instance due to the selected special equipment or the country version. This also applies to safety-related functions and systems.

## Cruise control

### The concept

Cruise control is available for use at speeds of approx. 20 mph/30 km/h and higher. The car then stores and maintains the speed that you specify using the lever on the steering column. In order to maintain the specified speed, the system brakes the vehicle when the engine braking effect is insufficient on downhill gradients.



Do not use cruise control

Do not use the system if unfavorable conditions make it impossible to drive at a constant speed, for instance:

- ▷ On curvy roads.
- ▷ In heavy traffic.
- ▷ On slippery roads, in fog, snow or rain, or on a loose road surface.

Otherwise, you could lose control of the vehicle and cause an accident. ◀

### Manual transmission

You can shift gears while cruise control is activated. An indicator lamp notifies you that you should shift gears when you drive for an extended period at very high or very low engine speeds, or the system is deactivated.

### One lever for all functions

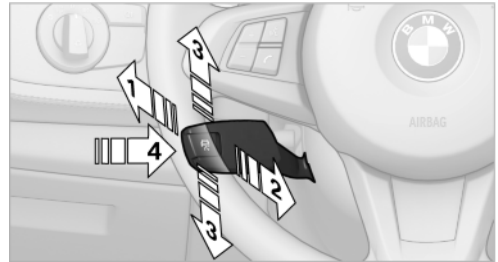

- 1 Storing and maintaining speed or accelerating
- 2 Storing and maintaining speed or decelerating
- 3 Deactivating cruise control
- 4 Resuming a speed stored beforehand

### Maintaining current speed

Push the lever, arrow 1, or pull it briefly, arrow 2.

The car's current speed is stored and maintained. It is displayed on the speedometer and briefly in the instrument cluster.

On uphill gradients, it may prove impossible to maintain the set speed if current engine power output is insufficient. If the engine braking effect is insufficient on downhill slopes, the system will brake the vehicle slightly.

### Increasing desired speed

Repeatedly press the lever to the resistance point or beyond, arrow 1, until the desired speed is reached.

- ▷ Each time the lever is pressed to the point of resistance, the desired speed increases by approx. 1 mph/1 km/h.
- ▷ Each time the lever is pressed beyond the resistance point, the desired speed is increased by up to 5 mph/10 km/h.

The system stores and maintains the speed.

## Accelerating using the lever

Accelerating slightly:

Press the lever to the resistance point, arrow 1, and hold until the desired speed is reached.

Accelerating significantly:

Press the lever beyond the resistance point, arrow 1, and hold until the desired speed is reached.

The vehicle accelerates without pressure on the accelerator pedal. The system stores and maintains the speed.

## Decreasing speed

Repeatedly pull the lever to the resistance point or beyond, arrow 2, until the desired speed is displayed.

- ▷ Each time the lever is pulled to the resistance point, the desired speed is decreased by approx. 1 mph/1 km/h.
- ▷ Each time the lever is pulled beyond the resistance point, the desired speed is reduced by up to 5 mph or 10 km/h until the minimum speed of 20 mph/30 km/h is achieved.

The system stores and maintains the speed.

## Interrupting the system

Push the lever upwards or downwards, arrow 3.

The displays in the speedometer change color.

In addition, the system is automatically interrupted in the following situations:

- ▷ When the brakes are applied.
- ▷ In cars with manual transmission, when gears are shifted very slowly or if neutral is engaged.
- ▷ In cars with Sport automatic transmission, when transmission position N is engaged.
- ▷ When DTC is activated or DSC is deactivated.
- ▷ When DSC or ABS is intervening.

Cruise control is not deactivated by depressing the accelerator pedal. Once the accelerator

pedal is released, the stored speed is achieved again and maintained.

## Warning lamp



The warning lamp comes on, for example, when cruise control has been deactivated as a result of DSC intervention.

## Deactivating the system

- ▷ Press the lever upward or downward twice, arrow 3.
- ▷ Switch off the ignition.

The stored speed is cleared.

## Resuming a speed stored beforehand

Press the button, arrow 4. The last stored speed is resumed and maintained.

## Displays in the instrument cluster



- 1 Stored speed
- 2 Selected speed is displayed briefly

If --- mph or --- km/h temporarily appears in the instrument cluster display, it is possible that the system prerequisites for operation are currently not met.

Call up Check Control messages, refer to page 67.

## Malfuction



The warning lamp comes on when the system has failed.

More information, refer to page 186.

## Park Distance Control PDC

### The concept

PDC supports you when parking.

Objects in front of or behind your vehicle that you are approaching slowly are indicated by acoustic signals.

### Measurement

Measurements are made by ultrasound sensors in the bumpers.

The range is approx. 6 ft/2 m.

An acoustic warning is first given:

- ▷ By the front sensors and two rear corner sensors at approx. 24 in/60 cm.
- ▷ By the rear middle sensors at approx. 5 ft/1.50 m.

### System limits



Check the traffic situation as well

PDC cannot serve as a substitute for the driver's personal judgment of the traffic situation. Check the traffic situation around the vehicle with your own eyes. Otherwise, an accident could result from road users or objects located outside of the PDC detection range.

Loud noises from outside and inside the vehicle may prevent you from hearing the PDC's signal tone. ◀



Avoid driving quickly with PDC

Avoid approaching an object quickly.

Avoid driving away quickly while PDC is not yet active.

For technical reasons, the system may otherwise be too late in issuing a warning. ◀

### Limits of ultrasonic measurement

The detection of objects can reach the physical limits of ultrasonic measurement, for instance:

- ▷ With tow bars and trailer hitches.
- ▷ With thin or wedge-shaped objects.
- ▷ With low objects.
- ▷ With objects with corners and sharp edges.

Low objects already displayed, e.g., curbs, can move into the blind area of the sensors before or after a continuous tone sounds.

High, protruding objects such as ledges may not be detected.

### False warnings

PDC may issue a warning under the following conditions even though there is no obstacle within the detection range:

- ▷ In heavy rain.
- ▷ When sensors are very dirty or covered in ice.
- ▷ When sensors are covered in snow.
- ▷ On rough road surfaces.
- ▷ In large buildings with right angles and smooth walls, e.g., in underground garages.
- ▷ In heavy exhaust.
- ▷ Due to other ultrasound sources, e.g., sweeping machines, high pressure steam cleaners or neon lights.

### Switching on automatically

Engage reverse gear with the engine running or the ignition switched on.

### Switching off automatically when driving forward

The system switches off when a certain distance or speed is exceeded.

Switch on the system again if necessary.

## Signal tones

When approaching an object, an intermittent tone is sounded that indicates the position of the object. For example, if an object is detected to the left rear of the vehicle, a signal tone sounds from the left rear speaker.

The shorter the distance to the object becomes, the shorter the intervals.

If the distance to a detected object is less than approx. 12 in/30 cm, a continuous tone is sounded.

If objects are located both in front of and behind the vehicle, an alternating continuous signal is sounded.

The intermittent tone is interrupted after approx. 3 seconds:

- ▷ If the vehicle stops in front of an object that is detected by only one of the corner sensors.
- ▷ If moving parallel to a wall.

The signal tone is switched off:

- ▷ When the vehicle moves away from an object by more than approx. 4 in/10 cm.
- ▷ When transmission position P is engaged.

## Malfunction

FarmaSOS.com



The indicator lamp in the instrument cluster comes on. PDC has failed.

Have the system checked.

To ensure full operability:

- ▷ Keep the sensors clean and free of ice.
- ▷ When using high-pressure washers, do not spray the sensors for long periods and maintain a distance of at least 12 in/30 cm.



# Climate

## Vehicle equipment

This chapter describes all series equipment as well as country-specific and special equipment offered for this model series. Therefore, it also

describes equipment that may not be found in your vehicle, for instance due to the selected special equipment or the country version. This also applies to safety-related functions and systems.

## Overview

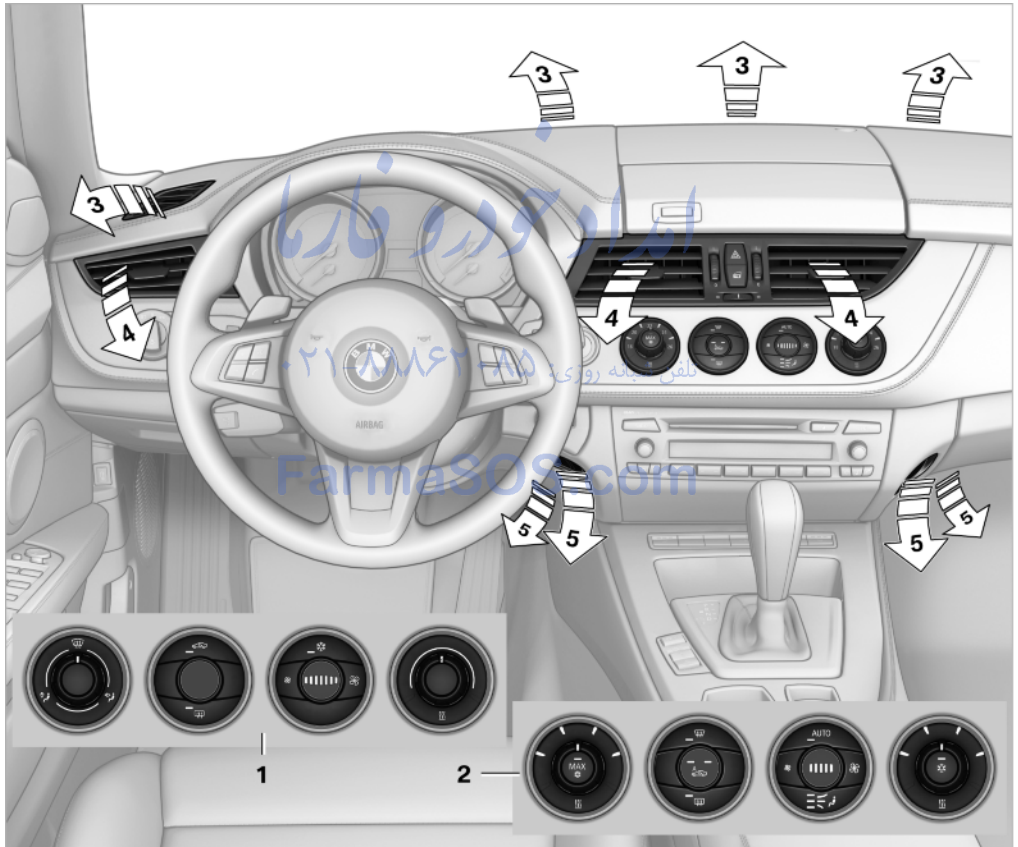

- 1 Equipment variant: air conditioner [90](#)
- 2 Equipment variant: automatic climate control [92](#)
- 3 Air vent: the airflow is directed toward the windshield and side windows
- 4 Air vent: air for the upper body area. The thumbwheels increase and decrease the air

supply continuously; the levers change the direction of the airflow.

5 Air vent: air for the knee area, footwell

## Air conditioner

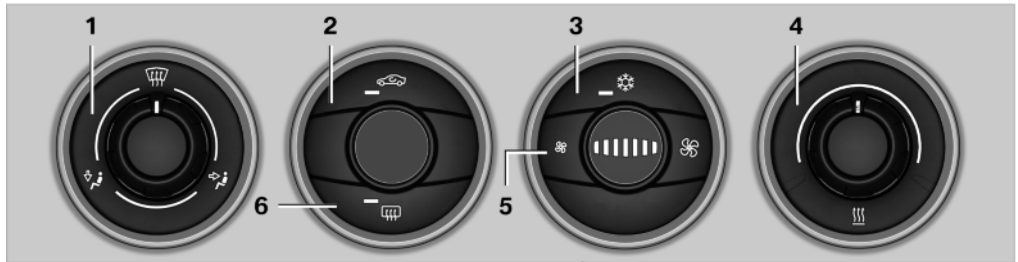

MM0911602AM

1 Vent settings

2 Recirculated air mode

3 Cooling function



4 Temperature

5 Air volume

6 Rear window defroster

### Vent settings



Direct the flow of air to the windows , to the upper body area , or to the knee area and footwell . Intermediate positions are possible. In the 6 o'clock position, a small amount of air is also directed toward the windows to keep them from fogging over.

### Recirculated air mode



If the air outside the car has an unpleasant odor or contains pollutants, shut off the supply to the interior of the car temporarily. The system then recirculates the air currently within the vehicle.

The recirculated air mode can also be activated/deactivated, refer to page 12, via a button on the steering wheel.



Only use recirculated air mode for a limited period

If condensation starts to form on the inside window surfaces during operation in the recircu-

lated air mode, you should switch it off while also increasing the air flow rate as required. The recirculated air mode should not be used continuously for lengthy periods; otherwise, the quality of the air inside the car will gradually deteriorate. ◀

### Air volume



Press the corresponding button. The higher the rate, the more effective the heating or cooling will be.

The air flow rate may be reduced or the blower may be switched off entirely to save on battery power.

### Switching the system on/off



Press the left button at the minimum fan speed. The blower and air conditioner are completely switched off and the air supply is cut off.

To switch on the air conditioner, set the desired air flow rate.

### Switching cooling function on/off



The cooling function cools and dehumidifies the incoming air before reheating it as required, according to the temperature setting. This function is only available while the engine is running.

The cooling function helps to prevent condensation on the windows or to remove it quickly.

Depending on the weather, the windshield may fog over briefly when the engine is started.

### Rear window defroster



The defroster switches off automatically after a certain time or when the hardtop is opened.

### Temperature



To increase the temperature, turn the rotary switch clockwise towards red. For a lower temperature, turn the rotary switch counter-clockwise towards blue.

### Defrosting windows and removing condensation

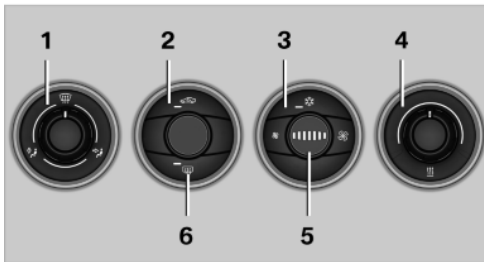

- 1 Air distribution 1 in position  .
- 2 Deactivate recirculated air mode 2.

- 3 Switch on cooling function 3.
- 4 Temperature 4 to the right, red.
- 5 Set the air flow rate 5 to the maximum level.
- 6 Switch on the rear window defroster 6 to defrost the rear window  .

### Ventilation

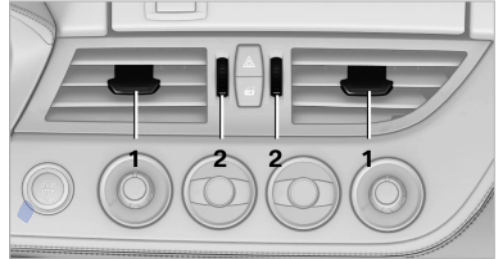

- 1 Use the lever to change the direction of the air flow
- 2 Use the thumbwheels to smoothly open and close the air vents

### Ventilation for cooling

Adjust the vents to direct the flow of cool air in your direction, for instance if the interior has become too warm.

### Draft-free ventilation

Adjust the vents to let the air flow past you.

### Microfilter

The microfilter removes dust and pollen from the incoming air. The microfilter is changed by your service center during routine maintenance work.

## Automatic climate control

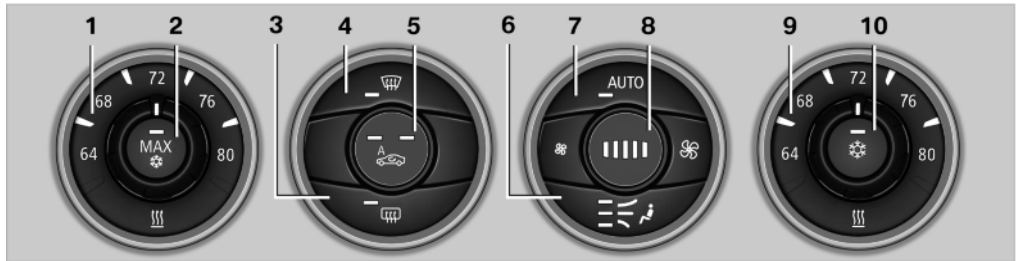

1M/091503DMA

- 1 Temperature, left side of passenger compartment
- 2 Maximum cooling
- 3 Rear window defroster
- 4 Defrosting windows and removing condensation
- 5 Automatic recirculated air control/recirculated air mode
- 6 Manual air distribution
- 7 AUTO program
- 8 Air flow rate, manual, climate level
- 9 Temperature, right side of passenger compartment
- 10 Switching cooling function on/off manually

امداد خودرو فارما

### Comfortable interior climate

For almost all conditions, the AUTO program 7 offers the optimum air distribution and air flow rate, refer to AUTO programs below. Select a comfortable interior temperature only.

The following sections contain more detailed information on the available setting options.

Most of these settings are stored for the remote control currently in use, Personal Profile settings, refer to page 21.

### Air distribution, manual

Depending on the selected setting, the air is directed to the windshield, to the upper body area, to the knee area and into the footwell.

### Adjusting air distribution manually



Press the button repeatedly until the air distribution is set as required. The corresponding LED lights up.

The manual air distribution is also switched on when the AUTO program is deactivated.

### Temperature



Set the desired temperatures individually for the driver's and passenger sides.

The automatic climate control achieves this temperature as quickly as possible regardless of the season, using maximum cooling or heating power if necessary, and then maintains it.

To give the automatic climate control enough time to achieve the set temperature, do not switch between different temperature settings in quick succession.

Maximum heating power can be obtained with the highest setting, regardless of the external temperature.

The lowest setting effects continuous cooling.

## Switching the cooling function on and off



The cooling function cools and dehumidifies the incoming air before reheating it as required, according to the temperature setting. This function is only available while the engine is running.

The cooling function helps to prevent condensation on the windows or to remove it quickly. Depending on the weather, the windshield may fog over briefly when the engine is started. The cooling function is switched on automatically with the AUTO program.

## Maximum cooling



The air is cooled as quickly as possible with the engine running.

The automatic climate control goes into recirculated air mode at the lowest temperature. Air flows at maximum rate from the vents for the upper body area. You should therefore open the vents for maximum cooling.

## AUTO program

The AUTO program automatically adjusts the air distribution to the windshield and side windows, toward the upper body area, and into the footwell and knee area.

The air flow rate and air distribution, in addition to your temperature specifications, will be adapted to outside influences as a result of seasonal changes, e.g., sunlight or window condensation.

The cooling function is switched on automatically with the AUTO program.

## Switching on/off



Press the button.

Manual air distribution and air flow rate are activated when the AUTO program is deactivated.

## AUTO program climate level

The climate levels can be used to vary the intensity when the AUTO program is switched on. For example, air flow is adjusted automatically to optimize climate control.



When the AUTO program is switched on, the climate level of the AUTO program can be selected using the buttons for controlling the manual air flow rate.

The selected climate level is displayed by an LED.

## Convertible program

When the hardtop is open, the convertible program is activated as well. In the convertible program, the automatic climate control is optimized for driving with the hardtop open. In addition, the air flow rate is increased as vehicle speed increases.

The effectiveness of the convertible program can be enhanced considerably by installing the wind deflector.

## Adjusting air flow rate manually



Press the left side of the button to reduce air flow. Press the right side of the button to increase it.

The air volume may be reduced automatically to save battery power. The display remains the same.

## Switching the system on/off

With the blower at its lowest setting, press the left side of the button to switch off the automatic climate control. All displays are cleared except for the rear window defroster if it is switched on.

Press any button except the rear window defroster to reactivate the automatic climate control.

### Residual heat

The heat stored in the engine is used to heat the interior.



This function can be switched on using the right-hand button under the following conditions:

- ▷ Up to 15 minutes after switching off the engine.
- ▷ When the engine is warm.
- ▷ With sufficient battery voltage.
- ▷ At an external temperature under 77 °F/ 25 °C.

The middle LED is lit when the function is on.

### Automatic recirculated air mode/ recirculated air mode



Switch on the desired operating mode by pressing this button repeatedly:

- ▷ LED off: outside air flows in continuously.
- ▷ Left LED on, automatic recirculated air control: a sensor detects pollutants in the outside air. If necessary, the system blocks the supply of outside air and recirculates the inside air. As soon as the concentration of pollutants in the outside air has decreased sufficiently, the system automatically switches back to outside air supply.
- ▷ Right LED on, recirculated air mode: the supply of outside air into the vehicle is permanently blocked. The system then recirculates the air currently within the vehicle.



Only use recirculated air mode for a limited period

If condensation starts to form on the inside window surfaces during operation in the recircu-

lated air mode, you should switch it off while also increasing the air flow rate as required. The recirculated air mode should not be used for an extended period of time, as the air quality inside the vehicle deteriorates steadily. ◀

### Defrosting and defogging windows



Quickly removes ice and condensation from the windshield and front side windows.

For this purpose, also switch on the cooling function.

### Rear window defroster



The defroster switches off automatically after a certain time or when the hardtop is opened.

### Ventilation

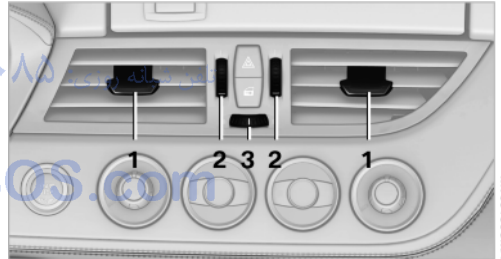

- 1 Use the lever to change the direction of the air flow
- 2 Use the thumbwheels to smoothly open and close the air vents
- 3 Thumbwheel for adjusting the amount of cool air from the vents to the upper body area. This can be used to adjust the air temperature for the upper body area.

### Ventilation for cooling

Adjust the vents to direct the flow of cool air in your direction, for instance if the interior has become too warm.

### Draft-free ventilation

Adjust the vents to let the air flow past you.

### Microfilter/activated-charcoal filter

The microfilter traps dust and pollen in the incoming air. The activated-charcoal filter provides additional protection by filtering gaseous pollutants from the outside air. Your service center replaces this combined filter during routine maintenance.

امداد خودرو فارما

تلفن شبانه روزی: ۰۲۱-۸۸۸۶۲۰۸۵

FarmaSOS.com

# Interior equipment

## Vehicle equipment

This chapter describes all series equipment as well as country-specific and special equipment offered for this model series. Therefore, it also describes equipment that may not be found in your vehicle, for instance due to the selected special equipment or the country version. This also applies to safety-related functions and systems.

## Universal Garage Door Opener

### The concept

The Universal Garage Door Opener can be used to operate up to 3 functions in radio-controlled systems, such as garage door drives or lighting systems. The Universal Garage Door Opener replaces up to 3 different hand-held transmitters. To operate it, the buttons on the interior rearview mirror must be programmed for the desired functions. The hand-held transmitter for the system is needed for the programming procedure.

 During programming

During programming and before activating a device using the integrated universal remote control, ensure that there are no people, animals, or objects in the range of movement of the remote-controlled device; otherwise, there is a risk of injury or damage.

Also follow the safety instructions of the hand-held transmitter. ◀

Before selling the vehicle, delete the stored functions for security reasons.

### Compatibility



If this symbol is printed on the packaging or in the operating instructions of the

system being operated, the system is generally compatible with the Universal Garage Door Opener.

If you have any questions, please contact:

- ▷ Your service center.
- ▷ [www.homelink.com](http://www.homelink.com) on the Internet.

HomeLink is a registered trademark of Johnson Controls, Inc.

## Controls on the interior rearview mirror

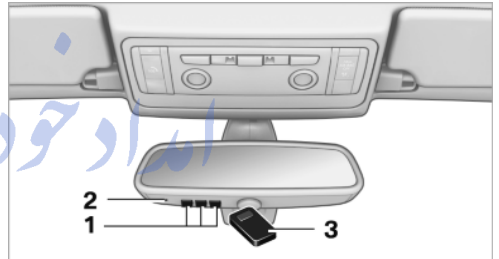

- 1 Buttons تلفن شبانه
- 2 LED
- 3 Hand-held transmitter, required for programming.

## Programming

### General information

1. Switch on the ignition.
2. Initial setup:

Press the right and left buttons on the interior rearview mirror simultaneously for approx. 20 seconds until the LED on the interior rearview mirror begins to flash. All programmed settings of the buttons on the interior rearview mirror are deleted.

3. Hold the hand-held transmitter of the system to be operated a distance of approx. 1 to 3 in/2.5 to 8 cm away from the buttons on the interior rearview mirror. The required



distance depends on the particular hand-held transmitter.

4. Press the button of the desired function on the hand-held transmitter and the button being programmed on the interior rearview mirror simultaneously and hold. The LED on the interior rearview mirror flashes slowly at first.
5. When the LED flashes more rapidly, release both buttons. Rapid flashing indicates that the button on the interior rearview mirror has been programmed.

If the LED does not flash faster after 60 seconds, change the distance between the interior rearview mirror and the hand-held transmitter and repeat the step. Multiple trials at different distances may be necessary. Wait at least 15 seconds between trials.

Canada: If the programming procedure with the hand-held transmitter was interrupted, press and hold the button on the interior rearview mirror and press the button on the hand-held transmitter multiple times for 2 seconds each and release.

6. To program additional functions on other buttons, repeat steps 3 to 5.

The systems can be operated with the buttons on the interior rearview mirror.

### Special characteristics of alternating-code radio systems

If the system cannot be operated after repeated programming, check whether the system to be operated uses an alternating-code system.

Read the operating instructions of the system or press and hold the programmed button on the interior rearview mirror. If the LED on the interior rearview mirror flashes rapidly at first and then lights up continuously for 2 seconds, the system is equipped with an alternating-code system.

This flashing LED pattern repeats itself for approx. 20 seconds.

In systems with an alternating-code system, the Universal Garage Door Opener and the system must be additionally synchronized.

Please obtain additional information on synchronization in the operating instructions of the system being set up.

The systems will be easier to synchronize with the aid of a second person.

Synchronization:

1. Park the vehicle within range of the remote-controlled system.
2. Program the corresponding button on the interior rearview mirror as described.
3. Identify and press the synchronization button on the system being set up. You have approx. 30 seconds for the next step.
4. Press and hold the button on the interior rearview mirror for approx. 3 seconds and then release it. Repeat this step up to three times if necessary to complete the synchronization procedure. When synchronization is completed, the programmed function is executed.

### Reprogramming individual buttons

1. Switch on the ignition.
2. Hold the hand-held transmitter at a distance of approx. 1 to 3 in/2.5 to 8 cm from the memory buttons.

The required distance depends on the particular hand-held transmitter.

3. Press the memory button of the Universal Garage Door Opener.
4. If the LED flashes slowly after approx. 20 seconds, press the transmit button on the hand-held transmitter.
5. Release both buttons when the LED flashes rapidly.

If the LED does not flash rapidly after approx. 60 seconds, change the distance and repeat the step.

Canada: if the LED does not flash rapidly after approx. 60 seconds, change the distance and repeat the step. If programming was aborted by the hand-held transmitter, hold down the memory button and press and release the button on the hand-held transmitter several times for 2 seconds.

## Controls



Prior to operation

Before operating a unit with the Universal Garage Door Opener, ensure that there are no people, animals, or objects in the range of movement of the system; otherwise, there is a risk of injury or damage.

Also follow the safety instructions of the hand-held transmitter. ◀

## Digital compass

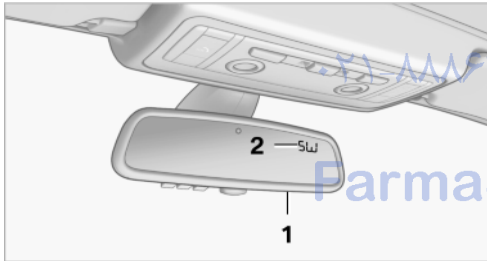

- 1 Adjustment button
- 2 Display

The display shows you the main or secondary compass direction in which you are driving.

### Operating concept

You can call up a number of functions by pressing the adjustment button with a pointed object

The system, such as the garage door, can be operated using the button on the interior rearview mirror with the engine running or the ignition switched on. When you are within the reception range of the system, press and hold the button until the function is initiated. The LED on the interior rearview mirror lights up continuously while the radio signal is being transmitted.

### Deleting stored functions

Press the right and left buttons on the interior rearview mirror simultaneously for approx. 20 seconds until the LED flashes rapidly. All stored functions are deleted. The functions cannot be deleted individually.

such as a ball-point pen. The following adjustment options are displayed one after the other, depending on how long you keep the adjustment button pressed:

- ▷ Press briefly: switch the display on/off.
- ▷ 3 to 6 seconds: set the compass zone.
- ▷ 6 to 9 seconds: calibrate the compass.
- ▷ 9 to 12 seconds: set left-hand/right hand steering.
- ▷ 12 to 15 seconds: set the language.

### Setting compass zones

Set the compass zone corresponding to your vehicle's geographic location so that the compass can function correctly; refer to the world map with compass zones.

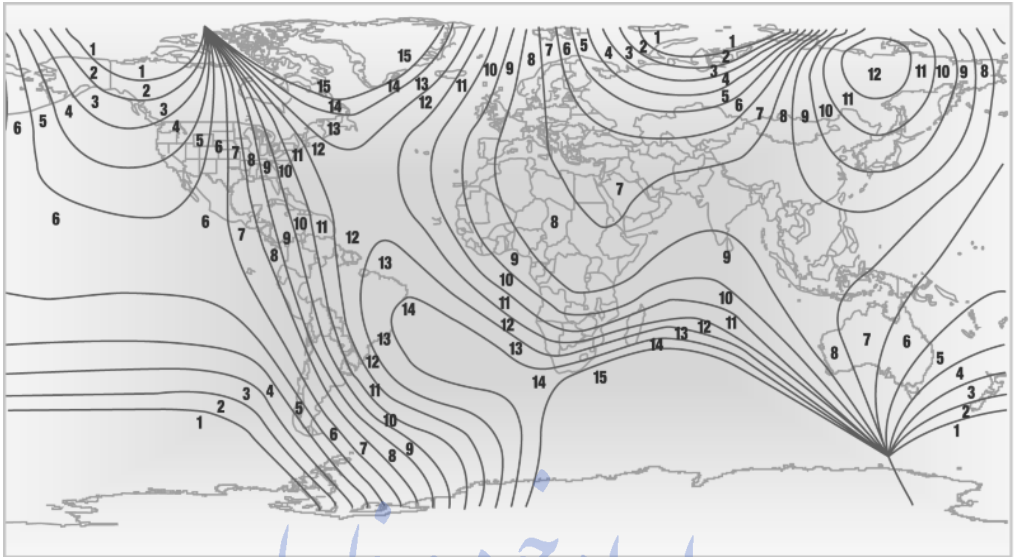

In order to set the compass zones, press and hold the adjustment button for 3-4 seconds. The number of the compass zone set is shown in the display.

To change the zone setting, briefly press the adjustment button repeatedly until the display shows the number of the compass zone corresponding to your current location.

The compass is operational again after approx. 10 seconds.

### Calibrating the digital compass

The digital compass must be calibrated in the following situations:

- ▶ An incorrect compass direction is shown.
- ▶ The cardinal direction displayed does not change even if the direction of travel changes.
- ▶ Not all compass directions are shown.

### Procedure

1. Make sure that there are no large metal objects or overhead power lines in the vicinity

of your vehicle and that you have enough space to drive in a circle.

2. Set the currently valid compass zone.
3. Ensure that the retractable hardtop is fully closed.
4. Press the adjustment button for 6-7 seconds to call up C. Then drive in at least one complete circle at a maximum speed of 4 mph/7 km/h. If the calibration was successful, the display C is replaced with the cardinal directions.
5. Open the retractable hardtop fully and repeat step 4.

### Setting right-hand/left-hand steering

Your digital compass is factory-set to right-hand or left-hand steering, in accordance with your vehicle.

### Setting the language

You can set the language of the display:

Press the adjustment button for 12-13 seconds. Briefly press the adjustment button again to switch between English "E" and German "O".

The setting is automatically saved after approx. 10 seconds.

## Connecting electrical devices

### Note

 Do not connect the charger to the socket  
Do not connect the battery charger to the socket installed in the vehicle at the factory as this could damage the vehicle. ◀

### Sockets

In your BMW, when the engine is running or the ignition is switched on, you can use electrical devices such as a hand lamp, car vacuum cleaner, etc., as long as one of the following sockets is available. The total load of all sockets must not exceed 140 Watt at 12 V. Avoid damaging the sockets by attempting to insert plugs of unsuitable shape or size.

#### Cigarette lighter socket

Access to socket: remove the lighter from the socket.

#### Under the center armrest

External audio device, refer to page 103.

#### In the passenger footwell

A socket is located on the left below the glove compartment.

## Trunk

Depending on your vehicle's equipment, the following storage spaces can be found in the cargo area:

- ▷ Rubber band for securing light objects
- ▷ Storage compartment.

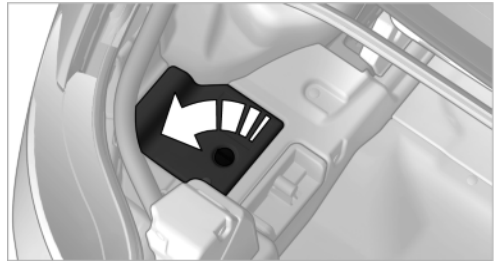

To open: turn the lock to the left, see arrow, and fold the cover up.

### Enlarging the cargo area

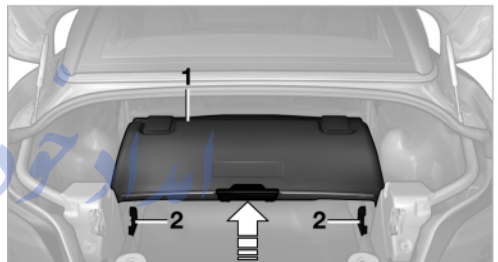

When the hardtop is closed you can enlarge the cargo area: تلفن شبانه

To do so, press the cargo area partition 1 upward.

Before opening the hardtop, pull the cargo area partition 1 down until it engages in both guides 2.

 Observe before opening and closing the hardtop

- ▷ Before moving the hardtop, ensure that there are no objects on or next to the cargo area partition; otherwise, parts of the hardtop may be damaged.
- ▷ Do not exceed the maximum loading height; refer to the sticker in the trunk showing a line indicating the maximum height.
- ▷ Do not use force to push down the cargo area partition. ◀

The retractable hardtop can only be opened if the cargo area partition is in its lowermost position and engaged on both sides.

## Through-loading opening with integrated transport bag

 Always secure skis

Always secure transported skis or similar objects with the ski support as they could otherwise endanger occupants during braking maneuvers and swerving. ◀

The transport bag lets you transport up to two pairs of standard skis safely and cleanly.

With the transport bag you can stow skis up to a length of 5.4 ft/1.70 m. When stowing skis with a length of 5.4 ft/1.70 m, the capacity of the transport bag is reduced as the bag narrows.

### Loading

1. Fold the cover down.



2. In the trunk: press the handle up and fold the cover down.



3. Undo the fastener and spread out the transport bag between the seats.

4. Insert the latch plate of the retaining strap into the belt buckle under the transport bag.

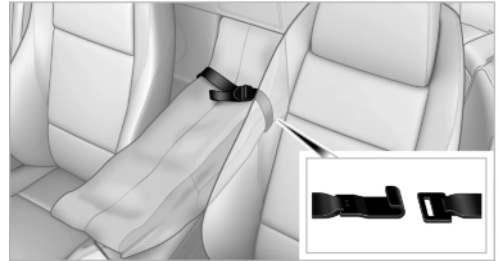

5. Load the transport bag. The zipper eases access to the stored items.

Only place clean skis in the transport bag. Wrap sharp edges to prevent damage.

### Securing cargo

 Securing the transport bag

Secure the transport bag by tightening the retaining strap; otherwise, the contents could present a source of danger to the passengers, for example during braking or evasive maneuvers. ◀ تلفن شماره ۰۰۱-۸۸۶۲۰۸۸

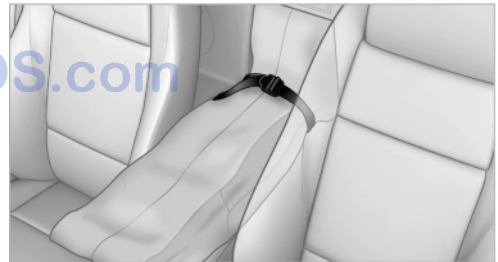

After loading, secure the transport bag and its contents. Tighten the retaining strap on the tensioning buckle for this purpose.

To store the transport bag, perform the steps described for loading in reverse order.

## Ski support



Always secure skis

Always secure transported skis or similar objects with the ski support as they could otherwise endanger occupants during braking maneuvers and swerving. ◀

1. Remove both covers 1 with the screwdriver.

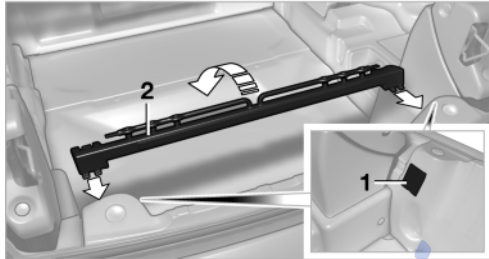

2. Attach the ski support 2 and fold it down, see arrow.
3. Pull the fastener up and attach the rear of the ski.

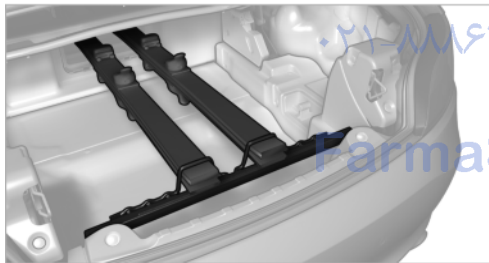

Prevent damage to the trunk lid

Before closing the trunk, ensure that the trunk lid cannot be damaged by the skis. ◀

## Removing the transport bag

The transport bag can be completely removed, e.g., for faster drying or to allow you to use other inserts.



In the trunk: press the handles up and fold the transport bag down fully.

More information on the various inserts available can be obtained from your service center.

امداد خودرو فارما

تلفن شبانه روزی: ۰۲۱-۸۸۶۲۰۸۵

ParmaSOS.com

# Storage compartments

## Vehicle equipment

This chapter describes all series equipment as well as country-specific and special equipment offered for this model series. Therefore, it also describes equipment that may not be found in your vehicle, for instance due to the selected special equipment or the country version. This also applies to safety-related functions and systems.

## Glove compartment

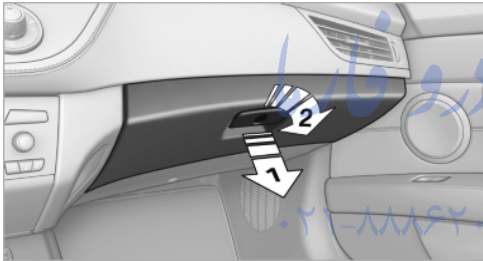

### Opening

Pull the handle, arrow 1.

The light in the glove compartment switches on.



Close the glove compartment again immediately

Close the glove compartment immediately after use while driving; otherwise, injury may occur during accidents. ◀

### Closing

Fold up the cover.

### Locking

Lock with a key, arrow 2.

If you hand out the remote control without the integrated key, refer to page 20, such as at a hotel, the glove compartment cannot be unlocked.

## Center armrest

### Storage compartment

The center armrest contains either two cupholders, a compartment or the cover for the snap-in adapter, depending on the equipment version.

### Locking the storage compartment

When you lock the vehicle from the outside, the storage compartment in the center armrest is locked as well.

### Opening

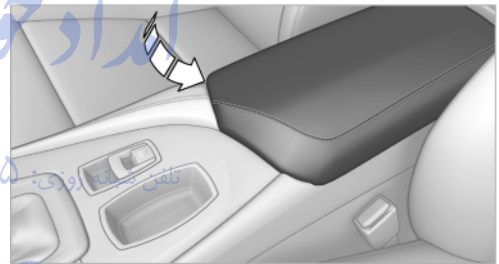

Fold the center armrest up, see arrow.

### Connection for an external audio device

An external audio device such as a CD or MP3 player can be connected and the audio tracks can be played over the car's loudspeaker system. Volume and tone can be set on the car radio.

► Professional Radio, refer to page 116.



## Storage compartments inside the vehicle



No non-slip mats on the dashboard

Do not use non-slip materials, such as non-slip mats, on the dashboard, or it could be damaged by the substances in the materials. ◀

The following compartments are available, depending on how your vehicle is equipped:

### Compartments in the doors

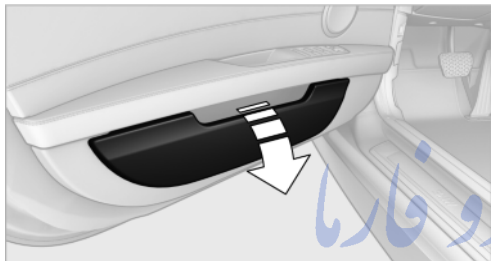

To open: fold open the cover.

### Compartment in the center console

There is an open storage compartment in the center console.

### Storage compartment in the dashboard

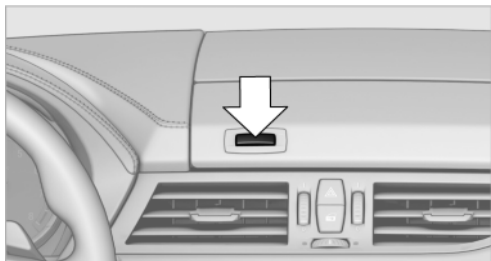

To open: press the button.

### Storage compartment in the partition



To open: pull the handle.

The intermediate floor of the storage compartment can be removed and inserted at various heights.

### Removing the storage compartment

The storage compartment can be removed completely to be able to use other inserts, for example.



In the trunk:

Press the handles up and fold the storage compartment completely down.

More information on the various inserts available can be obtained from your service center.

### Rear storage shelf behind the seats

This space can be used to store briefcases, for example.



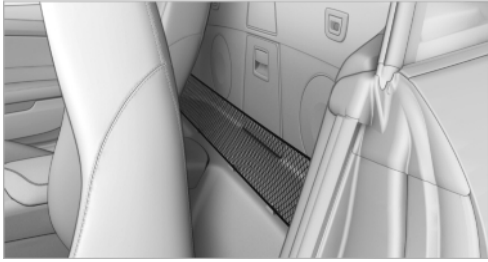

NM09173CMA



Observe when loading the rear storage shelf

- ▶ When loading the rear storage shelf, do not move both seats all the way forward while moving them to their uppermost position and leaning the backrests forward. Otherwise, the seats could hit and damage the seal on the windshield and the sun visor.
- ▶ Only transport light and small objects on the rear storage shelf; otherwise, braking maneuvers and swerving may lead to a safety hazard due to objects flying about the passenger compartment. Only transport heavy luggage in the trunk if it has been appropriately secured. ◀

## Cupholders



Shatter-proof containers and no hot drinks

Use light and shatter-proof containers and do not transport hot drinks. Otherwise, there is the increased danger of injury in an accident. ◀



Unsuitable containers

Do not forcefully push unsuitable containers into the cupholders. This may result in damage. ◀

## In the center armrest

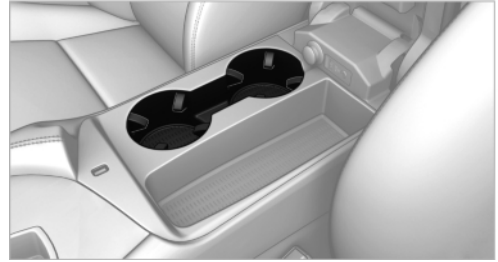

NM09173CMA

The cupholders are located in the center armrest.

## Attachable cupholder

### Attaching to the center console

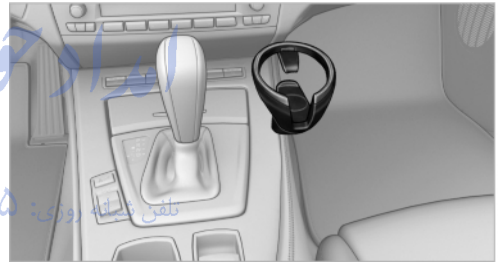

NM09173CMA

Mount the cupholder onto the center console so that it snaps into place.

### Storing in the glove compartment

Insert the cupholder into the holder in the glove compartment.



# امداد خودرو فارما

تلفن شبانه روزی: ۰۲۱-۸۸۸۶۲۰۸۵

[FarmaSOS.com](http://FarmaSOS.com)

## Driving tips

This section provides you with information useful in dealing with specific driving and operating conditions.

امداد خودرو فارما

تلفن شماره روزی: ۰۲۱-۸۸۸۶۲۰۸۵

FarmaSOS.com

# Things to remember when driving

## Vehicle equipment

This chapter describes all series equipment as well as country-specific and special equipment offered for this model series. Therefore, it also describes equipment that may not be found in your vehicle, for instance due to the selected special equipment or the country version. This also applies to safety-related functions and systems.

## Breaking-in period

### General information

Moving parts need to be broken in to adjust to each other.

The following instructions will help achieve a long vehicle life and good economy.

### Engine and differential

Always obey the official speed limits.

### Up to 1,200 miles/2,000 km

Do not exceed the maximum engine and road speeds:

- ▷ 4,500 rpm and 100 mph/160 km/h.

Do not drive with full-throttle operation, and do not use the transmission's kickdown mode or Launch Control.

### From 1,200 miles/2,000 km

The engine and vehicle speed can gradually be increased.

### Tires

Due to technical factors associated with their manufacture, tires do not achieve their full traction potential until after an initial breaking-in period.

Drive conservatively for the first 200 miles/300 km.

### Brake system

Brakes require an initial break-in period of approx. 300 miles/500 km to achieve optimized contact and wear patterns between brake pads and rotors. Drive cautiously during this break-in period.

### Clutch

The clutch requires an initial break-in period of approx. 300 miles/500 km to function at an optimal level.

During this break-in period, engage the clutch gently.

### Following part replacement

The same breaking in procedures should be observed if any of the components mentioned above have to be renewed in the course of the vehicle's operating life.

## General driving notes

### Ground clearance



Limited ground clearance

Note that the Z4 sDrive35 has limited ground clearance, for instance when driving into underground parking garages or over obstacles. Otherwise, the vehicle may be damaged. ◀

### Closing the trunk lid



Drive with the trunk lid closed

Only operate the vehicle with the trunk lid closed; otherwise, exhaust fumes could enter the passenger compartment. ◀

If the vehicle must be driven with the trunk lid open:

1. Close all windows.
2. Greatly increase the air flow rate of the air conditioner or automatic climate control.

### Hot exhaust system



Hot exhaust system

High temperatures are generated in the exhaust system.

Do not remove the heat shields installed and never apply undercoating to them. Make sure that flammable materials, e. g. hay, leaves, grass, etc. do not come in contact with the hot exhaust system during driving, while in idle position mode, or when parked. Such contact could lead to a fire, and with it the risk of serious personal injury as well as property damage.

Do not touch hot exhaust pipes; otherwise, there is the danger of getting burned. ◀

### Mobile communication devices in the vehicle



Mobile communication devices in the vehicle

It is not recommended to use mobile phones, such as mobile phones without a direct connection to an external aerial in the vehicle's passenger compartment. Otherwise, the vehicle electronics and mobile communication devices can interfere with each other. In addition, there is no assurance that the radiation generated during transmission will be discharged from the vehicle interior. ◀

### Hydroplaning

On wet or slushy roads, a wedge of water can form between the tires and road surface.

This phenomenon is referred to as hydroplaning. It is characterized by a partial or complete loss of contact between the tires and the road

surface, ultimately undermining your ability to steer and brake the vehicle.



Hydroplaning

When driving on wet or slushy roads, reduce your speed to prevent hydroplaning. ◀

### Driving through water

Drive through calm water only if it is not deeper than 9.8 inches/25 cm and at this height, no faster than walking speed, up to 6 mph/10 km/h.



Adhere to water depth and speed limitations

Do not exceed this water depth and walking speed; otherwise, the vehicle's engine, the electrical systems and the transmission may be damaged. ◀

### Braking safely

Your vehicle is equipped with ABS as a standard feature.

Applying the brakes fully is the most effective way of braking in situations when this is necessary.

The vehicle maintains steering responsiveness. You can still avoid any obstacles with a minimum of steering effort.

Pulsation of the brake pedal and sounds from the hydraulic circuits indicate that ABS is in its active mode.

### Objects in the area around the pedals



No objects in the area around the pedals

Keep floor mats, carpets, and any other objects out of the area of motion of the pedals; otherwise, the function of the pedals could be impeded while driving

Do not place additional floor mats over existing mats or other objects.

Only use floor mats that have been approved for the vehicle and can be properly fixed in place.

Ensure that the floor mats are securely fastened again when they are returned after being removed, such as for cleaning. ◀

### Driving in wet conditions

When roads are wet or there is heavy rain, briefly exert gentle pressure on the brake pedal every few miles.

Ensure that this action does not endanger other road users.

The heat generated in this process helps dry the brake discs and pads.

In this way braking efficiency will be available when you need it.

### Hills

Drive long or steep downhill gradients in the gear in which the least braking is required. Otherwise, the brake system may overheat, resulting in a reduction in the brake system efficiency.

You can increase the engine's braking effect by shifting down, going all the way to first gear, if necessary.

Downshifting in manual mode of the 8-gear Sport automatic transmission, refer to page 54.

Downshifting in manual mode of the 7-gear Sport automatic transmission with dual clutch, refer to page 57.

 Avoid load on the brakes

Avoid placing excessive load on the brake system. Light but consistent brake pressure can lead to high temperatures, brake wear and possibly even brake failure. ◀

 Do not drive in neutral

Never drive with the transmission in neutral, with the engine switched off or with the clutch depressed; otherwise, you will have neither the braking action of the engine or nor its power assistance when braking or steering. ◀

### Brake disc corrosion

Corrosion on the brake discs and contamination on the brake pads are furthered by:

- ▷ Low mileage.
- ▷ Extended periods when the vehicle is not used at all.
- ▷ Infrequent use of the brakes.

Corrosion occurs when the minimum pressure that must be exerted by the pads during brake applications to clean the discs is not reached.

Should corrosion form on the brake discs, the brakes will tend to respond with a pulsating effect that generally cannot be corrected.

### Condensation under the parked vehicle

When using the automatic climate control, condensation water develops that exits underneath the vehicle.

Therefore, traces of condensed water under the vehicle are normal.

### Loading تلفن شیما ۰۲۱-۸۸۶۲۰۰۰۰

 Overloading the vehicle

To avoid exceeding the approved carrying capacity of the tires, never overload the vehicle. Overloading can lead to overheating and increases the rate at which damage develops inside the tires. This could result in a sudden loss of tire inflation pressure. ◀

 Secure heavy objects

Never transport unsecured heavy or hard objects in the passenger compartment, as they could be thrown around and pose a safety hazard to the vehicle's occupants during abrupt braking or evasive maneuvers. ◀

 No fluids in the cargo area

Make sure that fluids do not leak into the cargo area; otherwise, the vehicle may be damaged. ◀

## Determining the load limit



MAN09191CMA

1. Locate the following statement on your vehicle's placard:
  - ▶ The combined weight of occupants and cargo should never exceed XXX kg or YYY lbs. Otherwise, damage to the vehicle and unstable driving situations may result.
2. Determine the combined weight of the driver and passengers that will be riding in your vehicle.
3. Subtract the combined weight of the driver and passengers from XXX kilograms or YYY pounds.
4. The resulting figure equals the available amount of cargo and luggage load capacity. For example, if the YYY amount equals 1,400 lbs and there will be five 150 lbs passengers in your vehicle, the amount of available cargo and luggage load capacity is 650 lbs: 1,400 lbs minus 750 lbs = 650 lbs.
5. Determine the combined weight of luggage and cargo being loaded on the vehicle. That weight may not safely exceed the available cargo and luggage load capacity calculated in Step 4.
6. If your vehicle will be towing a trailer, load from your trailer will be transferred to your vehicle. Consult the manual for transporting a trailer to determine how this may reduce the available cargo and luggage load capacity of your vehicle.

## Load

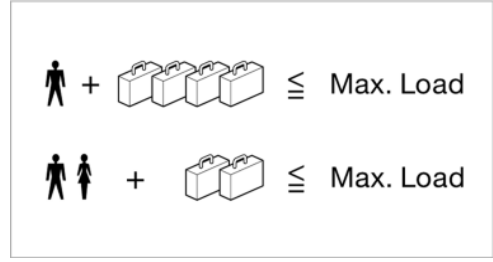

MAN09191CMA

The maximum load is the sum of the weight of the occupants and the cargo.

The greater the weight of the occupants, the less cargo that can be transported.

## Stowing cargo

### Trunk



MAN09191CMA

- ▶ Heavy cargo: stow as far forward and as low as possible, ideally directly behind the trunk separating wall.
- ▶ Cover sharp edges and corners.

 **Loading with the hardtop open**  
 Before opening the hardtop, fold down the cargo area partition and make sure the cargo area is loaded correctly; otherwise, parts of the hardtop could be damaged. ◀

Fold down the cargo area partition, refer to page 34.

## Lateral storage shelf

### Loading the rear storage shelf

When loading the rear storage shelf, do not move both seats all the way forward while moving them to their uppermost position and leaning the backrests forward. Otherwise, the seats could hit and damage the seal on the windshield and the sun visor. ◀

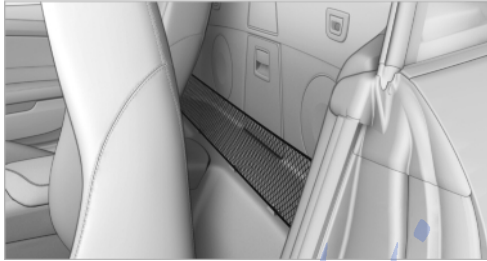

Light and small objects can be stored on the lateral storage shelf.

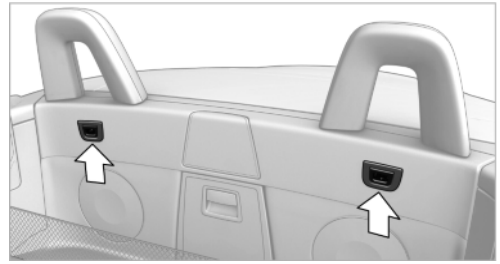

Bottom:



## Securing cargo

### Trunk

Use retaining straps, a luggage net or draw straps to secure small and lightweight items.

### Lateral storage shelf

You can obtain cargo straps from your service center. Four lashing eyes are provided behind the seats for attaching the cargo straps.

Adhere to the information included with the cargo straps.

### Lashing eyes on the lateral storage shelf

Top:

## Saving fuel

### General information

Your vehicle contains advanced technology for the reduction of fuel consumption and emissions.

Fuel consumption depends on a number of different factors.

The implementation of certain measures, driving style and regular maintenance, refer to page 168, can have an influence on fuel consumption and on the environmental impact.

### Remove unnecessary cargo

Additional weight increases fuel consumption.

### Remove attached parts following use

Remove auxiliary mirrors or rear-mounted luggage racks after use.

Attached parts on the vehicle impair the aerodynamics and increase the fuel consumption.



### Close both windows

An open window causes higher air resistance and thus increases fuel consumption.

### Check the tire inflation pressure regularly

Check and, if necessary, correct the tire inflation pressure, refer to page 155, at least twice a month and before starting on a long trip.

Low tire inflation pressure increases rolling resistance and thus raises fuel consumption and tire wear.

### Drive away without delay

Do not wait for the engine to warm up while the vehicle remains stationary. Start driving right away, but at moderate engine speeds.

This is the fastest way for the cold engine to reach its operating temperature.

### Look well ahead when driving

Avoid unnecessary acceleration and braking.

By maintaining a suitable distance to the vehicle driving ahead of you.

Driving smoothly and looking ahead reduces fuel consumption.

### Avoid high engine speeds

Use 1st gear to get the vehicle in motion. Beginning with 2nd gear, accelerate rapidly. When accelerating, shift up before reaching high engine speeds.

When you reach the desired speed, shift into the highest applicable gear and drive with the engine speed as low as possible and at a constant speed.

As a rule: driving at low engine speeds lowers fuel consumption and reduces wear.

### Use coasting conditions

When approaching a red light, take your foot off the accelerator and coast to a halt in the highest applicable gear.

On a downhill slope, take your foot off the accelerator and coast in a suitable gear.

The flow of fuel is interrupted while coasting.

### Switch off the engine during longer stops

Switch off the engine during longer stops, e.g., at traffic lights, railroad crossings or in traffic congestion.

Fuel savings are achieved after the vehicle is switched off for only approx. 4 seconds.

The Automatic Engine Start/Stop Function automatically switches the engine off during a stop. Additional information on the Automatic Engine Start/Stop Function, refer to page 47.

### Switch off any functions that are not currently needed

Functions such as the automatic climate control require a large amount of energy and consume additional fuel, especially in city and stop-and-go traffic.

Therefore, switch off these functions if they are not actually needed.

### Have maintenance carried out

Have vehicles maintained regularly to achieve optimal vehicle economy and operating life. Have the maintenance carried out by your service center.

Please also note the BMW Maintenance System, refer to page 168.



# امداد خودرو فارما

تلفن شبانه روزی: ۰۲۱-۸۸۸۶۲۰۸۵

[FarmaSOS.com](http://FarmaSOS.com)

## Entertainment

This chapter helps assure your enjoyment when  
receiving radio stations and playing CDs.

امداد خودرو فارما

تلفن شبانه روزی: ۰۲۱-۸۸۸۶۲۰۸۵

[FarmaSOS.com](http://FarmaSOS.com)

# Professional Radio

## Vehicle equipment

This chapter describes all series equipment as well as country-specific and special equipment offered for this model series. Therefore, it also

describes equipment that may not be found in your vehicle, for instance due to the selected special equipment or the country version. This also applies to safety-related functions and systems.

## General information

### At a glance

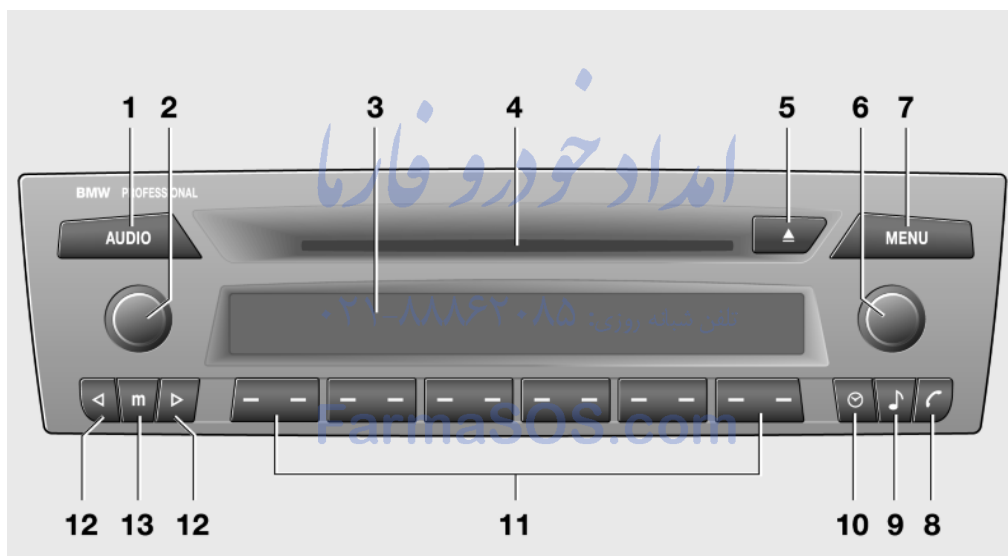

- 1 Change the audio sources.
- 2 On/off, volume control.
  - ▶ Press: switch on/off.
  - ▶ Turn: adjust the volume.
- 3 Display.
- 4 CD slot.
- 5 Eject the CD.
- 6 ▶ Turn: highlight the menu item on the display or set the value.
  - ▶ Press: select the highlighted menu item or store the settings.
- 7 Opens the main menu.
- 8 Place/end calls [134](#).
- 9 Show the tone settings.
- 10 Display the time.
- 11 Function buttons for selecting the menu items shown directly above them on the display.
- 12 Change the station or track.

13 Manually select the frequency.



## Representation in the Owner's Manual

"..." Identifies radio display texts used to select individual functions.

## Menu navigation

### Opening menu items

To display the menu items:

- ▶  Press the button for the audio sources menu.
- ▶  Press the button for the main menu.

### Selecting menu items

There are two ways to select a menu item on the display.

#### Using the right knob



- ▶ Highlight the menu item: turn the right knob.
- ▶ Select the menu item: press the right knob.

#### Using the function buttons

 Press the left or right side of the function button under the menu item.

If only one menu item is displayed above the function button, press the middle of the button.

## Symbols on the display

Symbol	Meaning
✓	Function is selected.
☑	Function is activated.
☐	The function is deactivated.
←	Leave the menu, one menu back.
◀ ▶	Display additional menu items.
⬆	Scroll display. The list contains more than two entries.

## Setting values

For setting numerical values or values on a scale:

1. Highlight the desired menu item and press the right knob.
2. Turn the right knob to set the value.
3. Press the right knob to store the value.

## Switching on/off



Press the left knob. The radio selects the audio source set last: radio, CD, external audio device, or USB audio interface.

## Listening to the radio with the ignition switched off

When the radio ready state or the ignition is switched off, the radio functions are available for

approx. 20 minutes. To listen to the radio, switch it back on.

To spare the battery, ensure that the radio is switched off when you leave the vehicle.

## Adjusting the volume



Turn the left knob. The setting is stored for the remote control currently in use.

When a call is placed using the hands-free system, the audio sources are muted.

## Speed-dependent volume and volumes of PDC signal tone and gong

- ▷ "PDC": volume of the PDC signal tone compared to the audio sources.
- ▷ "GONG": volume of the gong compared to the audio sources.
- ▷ "S-VOL": speed-dependent volume control.

Set the audio sources to a high volume to be able to adjust the volume of the signal tones more easily.

1.  Press the button.
2.  Select the symbol if necessary.
3. Select the desired volume setting.
4. Set the desired volume and press the right knob.

## Volume of external audio devices

An external audio device such as an MP3 player can be connected via the AUX-IN port in the center armrest and the audio tracks can be played over the car's loudspeaker system.

The volume of the external audio device can be adjusted to the car radio.

1.  Press the button.
2. "AUX"
3. "Vol-AUX"
4. Set the desired volume and press the right knob.



## Tone settings

- ▷ "BASS": depth adjustment.
- ▷ "TREBLE": treble adjustment.
- ▷ "FADER": front/rear volume distribution.
- ▷ "BAL": left/right volume distribution.
- ▷ "DOLBY": spatial acoustics effect.
- ▷ "EQSET": equalizer setting.

## Setting the treble, bass, and volume distribution

1.  Press the button.
2. Highlight the desired tone setting and press the right knob.
3. Create the desired setting and press the right knob.

## Switching on the spatial acoustics effect

1.  Press the button.
2.  Select the symbol if necessary.
3. "DOLBY"

## Equalizer

1. "EQSET"
2. Press the button of the desired frequency range.
3. Create the settings and press the right knob.

## Resetting the equalizer

1.  Press the button.
2. Turn the right knob.
3. "EQSET"
4. "RESET"

## Resetting the tone settings

The tone settings are reset to medium values.

1.  Press the button.

- "RESET"

## Time

### Displaying the time



Press the button.

When the ignition or the radio ready state is switched off, the time is displayed for several seconds.

### Setting the time, date, and time format

- Switch on the radio ready state or the ignition.
-  Press the button.
- "CONFIG"
- "TIME"
- Select the desired category.
- Create the settings and press the right knob.

### Setting the units of measure of the computer and the language

- Switch on the radio ready state or the ignition.
-  Press the button.
- "CONFIG"
- ▷ "DIST": change the unit of measure for the range.
  - ▷ "LANG": select the language of the display texts.
  - ▷ "CONSMP": change the unit of measure for the average fuel consumption.
  - ▷ "TEMP": change the unit of measure for the external temperature.
- Highlight the desired menu item and press the button.
- Create the desired setting.

The settings of the units of measure are adopted for display on the radio and in the instrument

cluster and are stored in the remote control currently in use.

## Computer

The following vehicle information can be call up via the computer:

- ▷ Average fuel consumption
- ▷ Average speed
- ▷ Range
- ▷ External temperature

### Displaying information

- Switch on the radio ready state or the ignition.
-  Press the button.
- "COMP"

#### Average fuel consumption

The average fuel consumption is calculated for the time during which the engine is running.

To start calculation of the average fuel consumption:

- "CONSMP"
- "RESET"

The previous display is set to zero and the system begins recalculating the average fuel consumption.

#### Average speed

The average speed is calculated for the time during which the engine is running.

To start calculation of the average speed:

- "SPEED"
- "RESET"

#### Estimated range

"RANGE"

The display shows the distance that can be driven on the remaining fuel quantity, taking into

consideration the average fuel consumption up to that point.

The computer only registers fuel quantities above approx. 1 gal/4 liters when refueling.

## Radio

### Listening to the radio

The radio is designed for reception in the FM and AM wavebands.

1. Switch on the radio, refer to page 117.

2.  Press this button if necessary.

3. "TUNER"

4. "FM" or "AM"

Press the corresponding button repeatedly until the desired waveband is displayed.

- ▷ FM: FM1, FM2, FMA
- ▷ AM: AM, AMA

### Selecting a station

The setting is stored for the remote control currently in use.

### Next station



Press the button.

The next station with reception is selected.

### Selecting the station manually by frequency

1.  Press the button.
2. ▷ Press the respective function button to set the desired frequency.
  - ▷ Turn the right knob until the desired frequency is set.

### Automatically updating the stations with the best reception, AUTOSTORE

In the FMA and AMA memory levels, stations are automatically stored according to their reception strength. If the AUTOSTORE function is not used, six stations can be manually stored in each of the FMA and AMA memory levels.

1. "FM" or "AM"

Press the corresponding button until the following is displayed:

"AUTOSTORE"

It may take several seconds for the stations to be stored and for one of these stations to be played back.

### Briefly playing and selecting a station

"SC"

All stations with reception are played briefly.

To interrupt the function and select a station:

"SC"

### Storing and retrieving a station

#### Memory locations

It is possible to store up to 30 stations.

- ▷ FM1, FM2, AM: six stations each.
- ▷ FMA, AMA: the six stations with the best reception (automatically) or any six stations (manually).

### Storing a station

1. "FM" or "AM"

Select the desired function repeatedly until the desired waveband is displayed.

2. Select the station.

3. ▷ "1" ... "12" for FM stations.
  - ▷ "1" ... "6" for AM stations.
  - ▷ "A1" ... "A6" for automatically stored stations.



Press and hold the function button under the desired memory location until the station is audible again after a brief interruption.

### Retrieving a stored station

#### 1. "FM" or "AM"

Select the desired function repeatedly until the desired waveband is displayed.

2. ▷ "1" ... "12" for FM stations.
- ▷ "1" ... "6" for AM stations.
- ▷ "A1" ... "A6" for automatically stored stations.

Press and hold the desired function button or turn the right knob until the desired station is displayed.

### Radio Data System, RDS

RDS broadcasts additional information, such as the station name or text messages, in the FM waveband. When playing a station with multiple frequencies, the system automatically switches to the frequency with the best reception, if needed.

Some stations broadcast the type of program received, or PTY, via RDS. This information is displayed briefly when the station is selected, for instance NEWS.

PTY can also be used to display catastrophe alerts, such as "ALARM".

The alert is issued on the loudspeakers.

### Switching the RDS on/off

1. "SET"
2. "RDS"

When the RDS is switched off, the PTY function is switched off as well.

### Switching the program type display on/off

1. "SET"
2. "PTY"

### HD Radio™ reception

Many stations broadcast both analog and digital signals. These stations can be received digitally and therefore with better sound quality. A digital radio network must be available to be able to receive digital stations.

License conditions

HD Radio™ technology manufactured under license from iBiquity Digital Corp. U. S. and Foreign Patents. HD Radio™ and the HD and HD Radio logos are proprietary trademarks of iBiquity Digital Corp.

### Activating/deactivating digital radio reception

1.  Press the button.
2. "TUNER"
3. "SET"
4. "HD"

### Displays

- ▷ "HD": a station is received digitally.
- ▷ "(HD)": a station broadcasts digital signals but digital radio reception is switched off.

In areas in which the selected station is not continuously received in digital mode, playback switches between analog and digital reception. In this case, switch off digital radio reception.

### Selecting the programs of a digital station

Some stations broadcast multiple programs. To select one of these programs:

1.   Press the button repeatedly until the desired digital station is displayed. If a station broadcasts multiple programs, the following display appears, for example: "HD1"
2. "LIST"

- "HD1" ... "HD8" Select the desired program. Up to eight programs can be selected per station.

### Displaying additional information

For digital stations, additional information can be displayed on the current track, such as the name of the artist.

"INFO"

### Operational displays

- ▷ "acquiring": the system is looking for digital stations.
- ▷ "No Signal": no digital stations are being received.

### Satellite radio

Over 100 different channels with high fidelity can be received. The channels are offered in fixed packages and must be activated.

You may experience signal drops and muting events related to this new technology.

### Activating or deactivated channels

-  Press the button.
- "SAT"
- "CAT"
- Select the desired category.  
The channels are displayed.  
✓ This symbol identifies the current channel.

### Activating

- Turn the right knob to select a channel that is not yet activated.
- Press the right knob to confirm a channel.  
A phone number and the electronic serial number, ESN, are displayed. The electronic serial number is required for activation.
- To have the channels activated, call the phone number.

### Deactivating

-  Press the button.
- "SAT"
- "SAT"  
Hold the button down.  
A phone number and the electronic serial number, ESN, are displayed. The electronic serial number is required for deactivation.
- To have the channels deactivated, call the phone number.

### Selecting and storing a channel

-  Press the button.
- "SAT"
- "CAT"
- Select the desired category.
- Select the desired channel.

To display all channels:

"ALL"

To store a channel:

-  Select the symbol.
- "SAT"  
Press the button repeatedly until the desired memory level, SAT 1 or SAT 2, is reached.
- "1" ... "6"  
Press and hold the function button under the desired memory location until the channel is audible again after a brief interruption.

### Changing to the current channel

"CURR"

### Additional information

The name of the channel and additional information on the current track are displayed, such as the name of the artist.

- Select the desired channel.
- "INFO"

## Changing the channel using the buttons



Press the button for the corresponding direction. The next enabled channel is opened.

## Search



1. Press and hold the button for the corresponding direction. The activated channels appear on the display one after the other.
2. Release the button to select the displayed channel.

## Notes

When there is a signal blockage or the transmission is suspended momentarily for more than 4 seconds, a message will appear on the display. Service may be interrupted or unavailable for specific reasons such as environmental or topographic conditions and others that Satellite Radio cannot directly control. Signal may not be available under tunnels, in parking garages, next to tall buildings, nearby trees with dense foliage, nearby mountains or other possible strong sources of radio interference. Service should resume normally after the source of signal unavailability has been cleared.

## CD/multimedia

### CD player and CD/DVD changer

#### Filling the CD player

Insert the CD into the CD drive with the printed side up.

Playback begins automatically.

Reading can take a few minutes with compressed audio files.

## Starting the CD player

A CD is contained in the CD player.

1. Switch on the car radio if necessary.
2.  Press the button.
3. "CD"

## Starting the CD/DVD changer

1. Switch on the car radio if necessary.
2. Fill the CD/DVD compartments, refer to page 125.
3.  Press the button.
4. "DVD"
5. Press the button of the desired CD/DVD number.

The corresponding CD/DVD number is shown on the display. At the end of the last track, the device changes to the next CD/DVD.

## Skipping to another track



Press the button repeatedly until the desired track is played.

With the right knob:

Turn the right knob until the desired track is played back.

## Fast forward/reverse



Hold the button down.

Tracks can be heard but are distorted.

## Briefly playing and selecting a track

"SC"

All tracks are played briefly one after the other.

To interrupt the function and select a track:

"SC"

## Random playback

"RND"



To end random playback:

"RND"

### Compressed audio files

CD players and CD/DVD changers can play back CDs or DVDs with compressed audio data: MP3 and WMA.

### Selecting a track

1. "LIST"
2. Select the desired directory using the right knob.
  - ▷  : press the right knob to open a directory.
  - ▷  : press the right knob to close a directory.
3. Select other directories if you wish.
4. Highlight the desired track and press the right knob.

You can scroll through the directories during playback.

To change to the current track:

"CURR"

### Displaying information on the track

Any information stored on the currently selected track can be displayed.

1. "LIST"
2. "TRACK"

## CD/DVD changer

### In the glove compartment

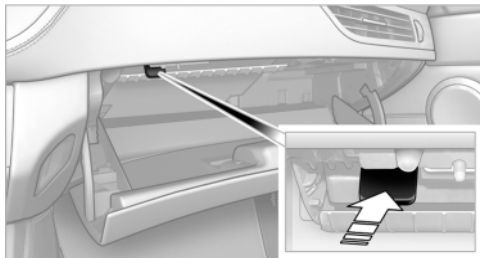

The BMW CD/DVD changer for six CDs/DVDs is located in the glove compartment.

Press the lever.

The CD/DVD changer is tilted down.

To close: fold the CD/DVD changer up until it engages.



Fold the CD/DVD changer up

Always fold the CD/DVD changer back up after filling and emptying it; otherwise, the DVD changer could be damaged. ◀

### Controls and displays

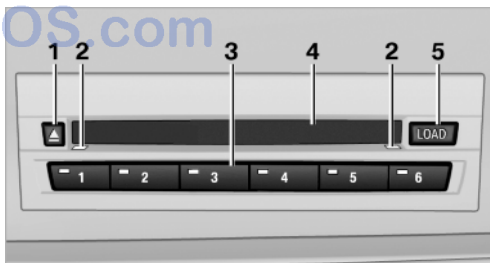

- 1 Empty CD/DVD compartments
- 2 LEDs on the CD/DVD slot
- 3 Buttons for CD/DVD compartments
- 4 CD/DVD slot
- 5 Load CD/DVD compartments

## Loading the CD/DVD compartments individually

1.  Press the button.  
The LED on the first empty compartment flashes.
2. Select another compartment if necessary.
3. Wait for the LEDs on the DVD slot to flash.
4. Insert a single CD or DVD in the middle.  
The CD/DVD is drawn in automatically and placed into the selected compartment.

### Sliding in CDs/DVDs

Do not insert the CD/DVD until the LEDs on the DVD slot are flashing; otherwise, the CD/DVD or the CD/DVD changer could be damaged. Do not continue to push on the CD/DVD; this may cause it to jam and prevent it from being able to eject again. ◀

## Filling all vacant CD/DVD compartments

1.  Press the button for a longer period.  
The LEDs on the empty CD compartments flash.
2. Wait for the LEDs on the DVD slot to begin flashing and then insert each CD or DVD into the center of the slot.  
The CDs/DVDs are drawn in automatically and placed into the vacant compartments.

### Sliding in CDs/DVDs

Do not insert the CD/DVD until the LEDs on the DVD slot are flashing; otherwise, the CD/DVD or the CD/DVD changer could be damaged. Do not continue to push on the CD/DVD; this may cause it to jam and prevent it from being able to eject again. ◀

After they are inserted, it may take several minutes for the CDs/DVDs to be read in.

## Removing a single CD/DVD

1.  Press the button.
2. Select the CD/DVD compartment.  
The CD/DVD is partially ejected.
3. Remove the CD/DVD.

## Removing all CDs/DVDs

1.  Press the button for a longer period.
2. Remove the CDs/DVDs.

## Malfunctions

If all LEDs on the CD/DVD changer flash rapidly, the system is malfunctioning.

To eliminate the malfunction:

1. Press one of the buttons:



The CD/DVD last inserted is ejected.

2. Remove the CD/DVD.

If the LEDs stop flashing rapidly, the CD/DVD changer is functional again.

## Audio playback

The audio track of a DVD can be played back even if video playback is not possible in the vehicle.



Only the main film without the previews or extras can be played back.

## Starting playback

A DVD is located in the DVD changer.

1.  AUDIO
2. "DVD"
3. Select the desired DVD.

## Selecting a chapter using the button

  Press the button repeatedly until the desired chapter is played.

## Fast forward/reverse

  Hold the button down.

## Selecting the language

The languages that are available depend on the DVD.

1. "AUDIO"
2. Select the desired language with the right knob.

## Operational displays

### CD player

- ▷ "Insert CD"  
The CD slot is empty.
- ▷ "Error CD"  
The CD cannot be read or is defective.
- ▷ "Temp. CD"  
Operating temperature is too high.

### CD/DVD changer

- ▷ "Insert DVD"  
The CD/DVD is incorrectly inserted or the compartments are empty.
- ▷ "Error DVD"  
The CD/DVD cannot be read or is defective.
- ▷ "Temp DVD"  
Operating temperature is too high.

## Notes

### CD/DVD player and changer

 Do not remove the cover  
BMW CD/DVD players and changers are officially designated Class 1 laser products. Do not operate if the cover is damaged; otherwise, severe eye damage can result. ◀

### CDs and DVDs

-  Use of CDs/DVDs
- ▷ Do not use self-recorded CDs/DVDs with labels applied, as these can become detached during playback due to heat buildup and can cause irreparable damage to the device.
  - ▷ Only use round CDs/DVDs with a standard diameter of 4.7 in/12 cm and do not play CDs/DVDs with an adapter, e.g., single CDs; otherwise, the CDs or the adapter may jam and no longer eject.
  - ▷ Do not use combined CDs/DVDs, e.g., DVD Plus, as the CDs/DVDs can jam and will no longer eject. ◀

### General malfunctions

- ▷ CD/DVD changers and players have been optimized for performance in vehicles. In some instances they may be more sensitive to faulty CDs/DVDs than stationary devices would be.
- ▷ If a CD/DVD cannot be played, first check whether it has been inserted correctly.

### Humidity

High levels of humidity can lead to condensation on the CD/DVD or the laser's scan lens, and temporarily prevent playback.

## Malfunctions involving individual CDs/ DVDs

If malfunctions occur only with particular CDs/ DVDs, this can be due to one of the following causes:

### Self-recorded CDs/DVDs

- ▷ Possible reasons for malfunctions with self-recorded CDs/DVDs are inconsistent data creation or recording processes, or poor quality or old age of the blank CD/DVD.
- ▷ Only label CDs/DVDs on the upper side with a pen intended for this purpose.

### Damage

- ▷ Avoid fingerprints, dust, scratches and moisture.
- ▷ Store CDs/DVDs in a sleeve.
- ▷ Do not subject CDs/DVDs to temperatures over 122 °F/50 °C, high humidity or direct sunlight.

### CDs/DVDs with copy protection

CDs/DVDs are often provided with a copy protection feature by the manufacturer. This can mean that some CDs/DVDs cannot be played or can only be played to a limited extent.

## MACROVISION

This product contains copyrighted technology that is based on multiple registered US patents and the intellectual property of the Macrovision Corporation and other manufacturers. The use of this copy protection must be approved by Macrovision. Media protected by this product - unless otherwise agreed with Macrovision - may only be used for private purposes. Copying of this technology is prohibited.

## External devices

### AUX-IN port

#### At a glance

- ▷ For connecting audio devices, e.g., MP3 player. The sound is output on the vehicle loudspeakers.
- ▷ Recommendation: use medium tone and volume settings on the audio device. The tone depends on the quality of the audio files.

### Connecting

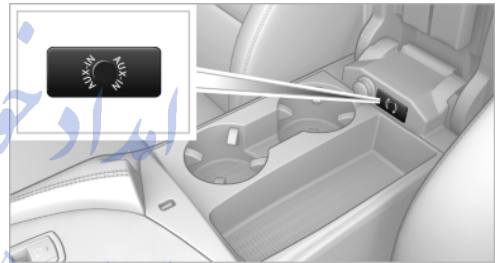

The AUX-IN port is in the center armrest.

Connect the headphone connector or line-out connector of the device to the AUX-IN port.

### Playback

1. Connect the audio device, switch it on and select a track on the audio device.
2.  Press the button.
3. "AUX"

### Volume

The volume of the sound output is dependent on the audio device. If this volume differs markedly from the volume of the other audio sources, it is advisable to adjust the volumes.

## Adjusting the volume

1.  Press the button.
2. "AUX"
3. "Vol-AUX"
4. Connect the audio device, switch it on and select a track on the audio device.

## USB audio interface/mobile phone audio interface

### At a glance

It is possible to connect external audio devices. The sound is output on the vehicle loudspeakers.

### Connectors for external devices

- ▷ Connection via USB audio interface: Apple iPod/iPhone, USB devices, e.g., MP3 players, USB flash drives, or mobile phones that are supported by the USB audio interface.
- ▷ Connection via snap-in adapter, refer to page 143, when equipped with extended connectivity of the music player in the mobile phone: Apple iPhone or mobile phones. Playback is only possible if no audio device is connected to the analog AUX-IN port.

Due to the large number of different audio devices available on the market, it cannot be ensured that every audio device/mobile phone is operable on the vehicle.

Ask your service center about suitable audio devices/mobile phones.

### Audio files

Standard audio files can be played back:

- ▷ MP3.
- ▷ WMA.
- ▷ WAV (PCM).
- ▷ AAC, M4A.
- ▷ Playback lists: M3U, WPL, PLS.

## File system

Standard file systems for USB devices are supported. The FAT 32 format is recommended.

## Connecting

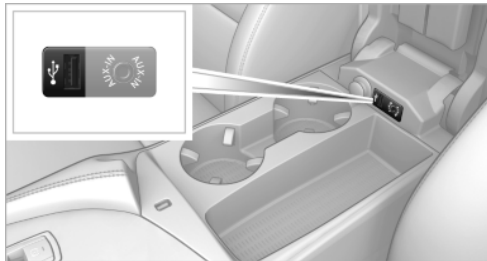

The USB audio interface is in the center armrest.

### Connection of Apple iPod/iPhone via USB audio interface

To connect the iPod, use the BMW cable adapter for the Apple iPod. Additional information can be obtained from your service center or on the Internet: [www.bmw.com](http://www.bmw.com).

Connect the Apple iPod/iPhone with the AUX-IN port and USB interface.

The Apple iPod/iPhone menu structure is supported by the USB audio interface.

### Connection of a USB device via the USB audio interface

Connect using a flexible adapter cable to protect the USB audio interface and the USB device against physical damage.

Connect the USB device to the USB interface.

### After connecting for the first time

Information on all music tracks, e.g. artist or type of music, as well as playback lists are transmitted into the vehicle. This may take some time, depending on the USB device and the number of tracks.

During transmission, the tracks can be called up via the file directory.



## Number of tracks

Information from up to four USB devices or for approx. 20,000 tracks can be stored in the vehicle. If a fifth device is connected or if more than 20,000 tracks are stored, information on existing tracks may be deleted.

## Copy protection

Music tracks with integrated Digital Rights Management (DRM) cannot be played.



## Playback

-  Press the button.
- "IPOD" or "USB"

## Changing the music track

### Skipping to another track



It is possible to skip to another track within the selected directory.

  Press the button repeatedly until the desired track is played.

With the right knob:

Turn the right knob until the desired track is played back.

### Fast forward/reverse

  Hold the button down.

Tracks can be heard but are distorted.

### Random playback

"RND"

To end random playback: "RND"

### Selecting a track

Depending on the connected device, the track can be selected via the following category:

- ▷ "LIST": playback lists.
- ▷ "DIR": device file structure.

▷ "GEN": musical genre.

▷ "ART": artist.

▷ "ALB": album.

- Select the desired category.
- If necessary, select the desired directory using the right knob.

▷  : press the right knob to open a directory.

▷  : press the right knob to close a directory.

3. Select other directories if you wish.

4. Highlight the desired track and press the right knob.

You can scroll through the directories during playback.

To change to the current track:

"CURR"

### Displaying information on the track

Any information stored on the currently selected track can be displayed.

"TRACK"

### Adjusting the volume

The volume of the sound output is dependent on the audio device. If this volume differs markedly from the volume of the other audio sources, it is advisable to adjust the volumes.

- "LEV"
- Turn the right knob until the desired volume is set and press the knob.

### Notes

Do not expose the audio device to extreme environmental conditions, such as very high temperatures; refer to the audio device operating instructions.

Depending on the configuration of the audio files, e.g., bit rates greater than 256 kbit/s, the files may not play back correctly in each case.

### Information on connection

- ▷ The connected audio device is supplied with a max. power of 500 mA if supported by the device. Therefore, do not additionally connect the device to a socket in the vehicle; otherwise, playback may be compromised.
- ▷ Do not use force when plugging the connector into the USB interface.
- ▷ Do not connect devices such as fans or lamps to the USB audio interface.
- ▷ Do not connect USB hard drives.
- ▷ Do not use the USB audio interface to recharge external devices.

امداد خودرو فارما

تلفن شبانه روزی: ۰۲۱-۸۸۸۶۲۰۸۵

FarmaSOS.com

# امداد خودرو فارما

تلفن شبانه روزی: ۰۲۱-۸۸۸۶۲۰۸۵

**FarmaSOS.com**



# امداد خودرو فارما

تلفن شبانه روزی: ۰۲۱-۸۸۸۶۲۰۸۵

[FarmaSOS.com](http://FarmaSOS.com)

## Communication

All of the options available to you for mobile communication with family, friends, business partners, and service providers are described in this chapter.

امداد خودرو فارما

تلفن شماره روزی: ۰۲۱-۸۸۸۶۲۰۸۵

FarmaSOS.com

# Telephone

## Vehicle equipment

This chapter describes all series equipment as well as country-specific and special equipment offered for this model series. Therefore, it also describes equipment that may not be found in your vehicle, for instance due to the selected special equipment or the country version. This also applies to safety-related functions and systems.

## At a glance

### Note

Equipment version with the full preparation package mobile phone or a hands-free system.

### The concept

Mobile phones can be connected with the vehicle via Bluetooth.

After these devices are paired once, they are recognized automatically when the ignition is switched on as soon as they are in the vehicle and can then be operated via the radio, the buttons on the steering wheel, and via voice activation.

After a suitable mobile phone is paired with the vehicle once, you can operate the mobile phone via the radio, the buttons on the steering wheel, and via voice activation.

Bluetooth® is a registered trademark of Bluetooth® SIG, Inc.

 Using the mobile phone while driving

Make entries only when traffic and road conditions allow. Do not hold the mobile phone in your hand while you are driving; use the hands-free system instead. If you do not observe this precaution, you can endanger the vehicle occupants and other road users. ◀

## Snap-in adapter

The snap-in adapter is used to:

- ▷ Hold the mobile phone.
- ▷ Recharge the battery.
- ▷ Connect the mobile phone to an outside antenna of the vehicle.

This provides for better network reception and consistent sound quality.

Avoid operating a mobile phone that has been detected by the vehicle on the keypad of the mobile phone, as this may lead to malfunctions.

## Approved mobile phones

Details on which mobile phones and external devices with a Bluetooth interface are supported by the mobile phone preparation package can be obtained at [www.bmwusa.com/bluetooth](http://www.bmwusa.com/bluetooth).

### Notes

At high temperatures, the charging function of the mobile phone may be limited and functions may not be executed.

## Playing music from the mobile phone

Depending on your mobile phone and the vehicle equipment, you can play the music data of the mobile phone in the vehicle.

## Controls

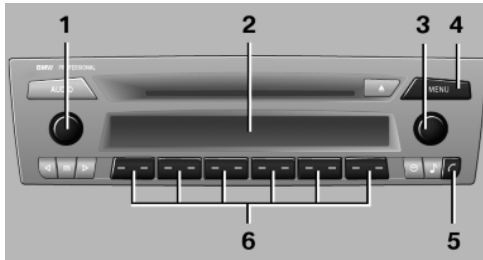

- 1 On/off, volume control.
- 2 Display.
- 3
  - ▷ Turn: highlight the menu item on the display or set the value.
  - ▷ Press: select the highlighted menu item or store the setting.
- 4 Opens the main menu.
- 5 Redial, accept a call, start dialing, terminate a call and change to the Telephone menu.
- 6 Function buttons for selecting the menu items shown directly above them on the display.

## Menu navigation

### Selecting menu items

There are two ways to select a menu item on the display.

### Using the right knob



- ▷ Highlight the menu item: turn the right knob.

- ▷ Select the menu item: press the right knob.

### Using the function buttons

**SET SC** Press the left or right side of the function button under the menu item.

If only one menu item is displayed above the function button, press the middle of the button.

### Representation in the Owner's Manual

"..." Identifies radio display texts used to select individual functions.

### Symbols on the display

Symbol	Meaning
✓	Function is selected.
←	Leave the menu, one menu back.
◀ ▶	Display additional menu items.
⬇	Scroll display. The list contains more than two entries.
📶	Reception of the wireless network: the display depends on the signal strength.
📞	Using the hands-free system.
✉	Message not read.
📧	Message read.

## Pairing/unpairing the mobile phone

### Requirements

- ▷ The mobile phone is suitable, refer to page 134.
- ▷ The mobile phone is ready for operation.
- ▷ Bluetooth is activated in the vehicle and on the mobile phone.

- ▷ Bluetooth presettings may need to be made on the mobile phone, e.g., for a connection without confirmation or visibility, refer to the mobile phone operating instructions.
- ▷ A number with at least four and a maximum of 16 digits was defined as the Bluetooth passkey. It is only required once for pairing.
- ▷ The ignition is switched on.

## Activating/deactivating Bluetooth

Bluetooth is not permitted everywhere. Comply with all safety guidelines and regulations.

To activate the connection:

1. Switch on the radio ready state or the ignition.
2.  Press the button.
3. "PHONE"
4. "BT-ON"

To deactivate the connection again:

1. "BT"
2. "BT-OFF"
3. "YES"

## Pairing and connecting



Pairing the mobile phone

To avoid becoming distracted and posing an unnecessary hazard both to your own vehicle's occupants and to other road users, only pair the mobile phone while the vehicle is stationary. ◀

1. Switch on the radio ready state or the ignition.
2.  Press the button.
3. "PHONE"
4. "BT"
5. "PAIR"

Turn the right knob to display the Bluetooth name of your vehicle.

6. To perform additional steps on the mobile phone, refer to the mobile phone operating instructions: for instance, search for or connect the Bluetooth device or a new device.

The Bluetooth name of the vehicle appears on the mobile phone display.

7. Select the Bluetooth name of the vehicle on the mobile phone display.

You are prompted by the radio or mobile phone to enter the same Bluetooth passkey.

8. Enter the passkey on the mobile phone and confirm it.

9. "ADD"

10. Enter the same passkey on the radio using the function buttons and confirm it.

To delete the last digit: "DELETE"

11. "OK"

Press twice if necessary.

If pairing was successful, the mobile phone appears on the radio display.

Four mobile phones can be paired with the vehicle at once. تلفن شتاب

If pairing was unsuccessful: What to do if..., refer to page 137.

## Repeating the pairing procedure/help

If pairing failed:

1. "REPEAT"
2. Repeat steps 6 to 10.

To display the Customer Relations phone number: "CALLS"

Turn the right knob to display the Customer Relations phone number and information needed for pairing.

## Following the initial pairing

- ▷ The mobile phone is detected/connected in the vehicle within a short period of time when the engine is running or the ignition is switched on.



- ▷ The phone book entries of the telephone stored on the SIM card or mobile phone are transmitted to the vehicle after detection, depending on the mobile phone.
- ▷ Four mobile phones can be paired.
- ▷ Specific settings may be necessary in some mobile phones, e.g., authorization or a secure connection; refer to the mobile phone operating instructions.

### Connecting a particular mobile phone

If more than one mobile phone is detected by the vehicle, the first mobile phone on the list is connected. A different detected mobile phone may be connected with the vehicle.

✓ The mobile phone is connected with the vehicle.

A different mobile phone can be connected by selecting it.

1. Switch on the radio ready state or the ignition.
2.  Press the button.
3. "PHONE"
4. "BT"
5. Turn the right knob until the mobile phone to be connected is displayed.
6. "PRIO"

Press the button repeatedly until the desired position is reached.

### Unpairing the mobile phone

1. Switch on the radio ready state or the ignition.
2.  Press the button.
3. "PHONE"
4. "BT"
5. Turn the right knob until the mobile phone to be unpaired is displayed.

6. "DELETE"
7. "YES"

### What to do if...

Information on suitable mobile phones, refer to page 134.

The mobile phone could not be paired or connected.

- ▷ Is Bluetooth activated in the vehicle and on the mobile phone? Activate Bluetooth on the vehicle and on the mobile phone.
- ▷ Do the Bluetooth passkeys on the mobile phone and the vehicle match? Enter the same passkey on the mobile phone and on the radio.
- ▷ Did it take longer than 30 seconds to enter the passkey? Repeat the pairing procedure.
- ▷ Are too many Bluetooth devices connected to the mobile phone or vehicle? Delete connections with other devices if necessary.
- ▷ Is the mobile phone in power-save mode or does it have only a limited remaining battery life? Charge the mobile phone in the snap-in adapter or via the charging cable.
- ▷ Depending on the mobile phone, it is possible that only one mobile phone can be connected to the vehicle. Unpair the connected mobile phone from the vehicle and pair and connect only one mobile phone.

The mobile phone no longer reacts?

- ▷ Switch the mobile phone off and on again.
- ▷ Is the ambient temperature too high or low? Do not expose the mobile phone to extreme environmental conditions.

No phone book entries or only some phone book entries are displayed, or they are incomplete.

- ▷ Transmission of the phone book entries is not yet complete.
- ▷ It is possible that only the phone book entries of the mobile phone or the SIM card are transmitted.

- ▷ It may not be possible to display phone book entries with special characters.
- ▷ The number of phone book entries to be stored is too high.
- ▷ Is the data volume of the contact too large, e. g., due to stored information such as notes? Reduce the data volume of the contact.

The phone connection quality is poor.

- ▷ The strength of the Bluetooth signal on the mobile phone can be adjusted, depending on the mobile phone.
- ▷ Insert the mobile phone into the snap-in adapter or place it in the area of the center console.
- ▷ Adjust the volume of the microphone and loudspeakers.

If all points in this list have been checked and the required function is still not available, contact Customer Relations or the service center.

## Controls

The following functions can be operated on the radio:

- ▷ Accept/reject a call.
- ▷ Dial a phone number.
- ▷ Dial a phone number from the phone book.
- ▷ Dial a stored phone number, such as from the list of accepted calls.
- ▷ In conjunction with the full preparation package mobile phone: BMW Assist, refer to page 145.

When the ignition and the radio ready state are switched off, such as after the remote control is removed, an existing call can be continued for up to 25 minutes on the hands-free system.

## Adjusting the volume



Turn the knob until the desired volume is selected. The setting is stored for the remote control currently in use.

The vehicle automatically adjusts the volume of the microphone on the telephone and the volume of the called party. Depending on the mobile phone, the volumes may need to be adjusted. The settings can only be created during a call and must be adjusted separately for each telephone. The settings are deleted when the telephone is unpaired.

## Incoming call

### Receiving calls

If the number of the caller is stored in the phone book and is transmitted by the network, the name of the contact is displayed. Otherwise, only the phone number is displayed.

### Accepting a call



Briefly press the button on the steering wheel or radio.

or

"YES"

### Rejecting a call

"NO"

### Ending a call



Briefly press the button on the steering wheel or radio.

or  
"END"

## Entering a phone number

### Dialing a number

1. Switch on the radio ready state or the ignition.
2.  Press the button.
3. "PHONE"
4. "#"
5. Enter the desired phone number on the buttons 0–9.

To delete the last digit: "DEL"

6.  Briefly press the button on the steering wheel or radio.  
or  
Press the right knob to dial the phone number.

### Phone book

Dialed phone numbers, incoming calls and entries in the phone book are stored on lists if the mobile phone is connected to the vehicle via Bluetooth.

Five lists are available:

- ▷ "A-Z"  
Entries of the phone book of the SIM card or of the mobile phone, which consist of a name and phone number, are sorted in alphabetical order.
- ▷ "TOP8"  
The Top 8 list contains the eight phone numbers that were dialed most frequently.
- ▷ "LAST8"  
The last eight phone numbers that were dialed are stored. The phone number dialed last is at the top of the list.
- ▷ "CALLS"

The phone numbers of the last eight accepted calls are stored. For this to be possible, it must be possible to transmit the phone number of the caller.

- ▷ "MISSED"

The phone numbers of the last eight calls that were not accepted are stored. For this to be possible, it must be possible to transmit the phone number of the caller.

### Dialing a phone number from the phone book

The list A-Z is available for phone book entries. If entries with different names but the same phone number are transferred to the vehicle from the mobile phone, only one entry is displayed.

The display of the phone book entries on the radio may differ from the display on the mobile phone, such as the order of the first and last names.

1. Switch on the radio ready state or the ignition.  
تلفن شماره زوری: ۰۲۱-۸۸۸۶۲۰۸۵
2.  Press the button.
3. "PHONE"
4. "A-Z"

5. ◀ ▶ The arrows indicate that additional letters can be displayed.

Turn the right knob to display additional letters if necessary.

6. Turn the right knob to select the first letter of the entry.
7. Select the entry with the function button.  
The phone number is dialed.

To display all entries:

1. Turn the right knob to select the first letter of the entry and press the knob.
2. Turn the right knob to select the desired entry and press the knob.  
or



Press the button on the steering wheel or radio to dial the number.



The phone number is dialed.

### Editing and dialing a phone number from the phone book

You can edit the phone number of an entry before making a call. This change is not stored in the phone book.

1. Selecting an entry.
2. "EDIT"
3. To delete a digit: "DEL"
4. Enter additional digits on the buttons 0–9.
5. Press the right knob to dial the phone number.

### Dialing a phone number from the phone book using the buttons on the steering wheel

1.  Press and hold the button to display the Telephone menu.
2. Press the arrow buttons on the steering wheel to leaf through the phone book.
3.  Press the button to dial the phone number.

### Dialing a phone number stored in a list

To select an entry and establish a connection:

1. Switch on the radio ready state or the ignition.
2.  Press the button.
3. "PHONE"
4. Select a list, for instance "TOP8"
5. Turn the right knob to select an entry and press the knob to dial the phone number.

### Deleting an individual entry

1. Select an entry from the list.

2. "DEL"

### DTMF suffix dialing

DTMF suffix dialing can be used for gaining access to network services or for controlling devices, e.g., to make a remote inquiry of an answering machine. The DTMF code is needed for this purpose.

This function is only available if a connection exists and if the hands-free system is being used.

1. "Keypad"
2. Enter the DTMF code on the buttons 0–9.
3. If necessary, press and hold the function button on the right or left to enter special characters.

### Displaying the call duration

During a call:

"DURAT"

### Hands-free system

#### General information

Calls that are being made on the hands-free system can be continued on the mobile phone and vice versa.

#### From the mobile phone to the hands-free system

Calls that were begun outside of the Bluetooth range of the vehicle can be continued on the hands-free system with the ignition switched on.

Depending on the mobile phone, the system automatically switches to the hands-free system.

If the system does not switch over automatically, follow the instructions on the mobile phone display; refer also to the mobile phone operating instructions.

## From the hands-free system to the mobile phone

Calls that are made on the hands-free system can in some cases be continued on the mobile phone; this depends on the mobile phone.

Follow the instructions on the mobile phone display; refer also to the mobile phone operating instructions.

## Voice operation

### General information

Depending on the vehicle equipment, the mobile phone can be operated by means of voice activation as described below.

### The concept

- ▶ The mobile phone can be operated without taking your hands from the steering wheel.
- ▶ In many cases, the entries are accompanied by announcements or questions.
- ▶ ›...‹ Verbal instructions for voice operation.

### Using voice activation

#### Activating the voice activation system

1.  Press the button on the steering wheel.
2. Say the command.

#### Terminating the voice activation system

-  Press the button on the steering wheel or ›Cancel‹.

### Possible commands

#### Having possible commands read aloud

-  Press the button on the steering wheel.  
›Help‹.

Possible commands are announced.

The digits from zero to nine are recognized. The digits can be spoken separately or combined in a sequence to accelerate the entry.

### Using alternative commands

The system often recognizes a number of different commands to run a function; for instance:

›Dial name‹ or ›Name‹

### Example: dialing a phone number

1.  Press the button on the steering wheel.
2. ›Dial number‹  
The system says: »Please say the number«.
3. For instance, ›123 456 790‹  
The system says: »123 456 790. Continue?«.
4. ›Dial‹  
The system says: »Dialing number«.

### Calling

#### Dialing a phone number

1. ›Dial number‹
2. Say the phone number.
3. ›Dial‹

#### Correcting the phone number

The sequence of digits can be deleted after the system has repeated the digits.

›Correct number‹

The command can be repeated as often as necessary.

#### Deleting a phone number

›Delete‹

All digits entered up to that point are deleted.

## Redialing

›Redial<

## Voice phone book

Depending on how your vehicle is equipped, it may be necessary to create your own voice phone book.

The entries must be entered using voice activation and are separate from the memory in the mobile phone. Up to 50 entries can be set up.

## Saving an entry

- ›Save name<
- Say the name. Do not exceed the speaking duration of approx. 2 seconds.
- Say the phone number after being prompted to do so by the system.
- ›Save<

## Deleting an entry

- ›Delete name<
- Say the name after being prompted to do so.
- Confirm the prompt: ›Yes<

## Deleting all entries

- ›Delete phonebook<
- Confirm the prompt: ›Yes<
- Confirm the prompt again: ›Yes<

## Reading and selecting entries

- ›Read phonebook<
- When the desired entry is read aloud: say ›Dial number<

## Selecting an entry

- ›Dial name<
- Say the name after being prompted to do so.
- Confirm the prompt: ›Yes<

## Adjusting the volume



Turn the left knob during an announcement.

- ▶ The volume remains constant even if the volume of other audio sources is changed.
- ▶ The volume is stored for the remote control currently in use.

## Notes

Do not use voice operation to initiate an Emergency Request. In stressful situations, the voice and vocal pitch can change. This can unnecessarily delay the establishment of a telephone connection.

Instead, use the SOS button, refer to page 176, in the vicinity of the interior mirror.

## Environmental conditions

- ▶ Say the commands, numbers, and letters smoothly and with normal volume, emphasis, and speed.
- ▶ Keep the doors, windows, and retractable hardtop closed to prevent noise interference.
- ▶ Avoid making other noise in the vehicle while speaking.

## BMW phone numbers

You can have several service phone numbers displayed even if BMW Assist is not activated. When you activate BMW Assist, the services of BMW Assist become available, refer to page 145.

- "Road Assist": BMW Roadside Assistance, if you require help in the event of a breakdown.
- "Serv. Appt.": BMW center, if you wish to arrange a service appointment.
- "Cust Relat.": Customer Relations, for information on all aspects of your vehicle.

## Displaying the phone numbers

1. Switch on the radio ready state or the ignition.
2.  Press the button.
3. "BMW"
4. Turn the right knob until the desired phone number is displayed.

## Snap-in adapter

### General information

More information on compatible snap-in adapters that support the functions of the mobile phone is available at the service center.

### Notes

At high temperatures, the charging function of the mobile phone may be limited and functions may not be executed.

When using the mobile phone via the vehicle, note the operating instructions of the mobile phone.

### Installation position

In the center armrest.

## Inserting/removing the snap-in adapter

1. Press button 1 and remove the cover.

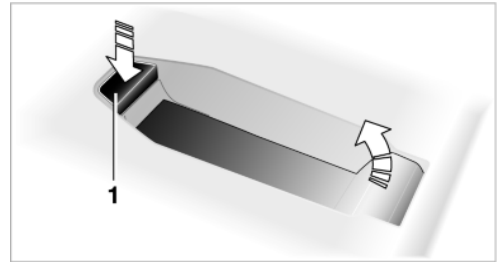

2. Insert the snap-in adapter at the front, arrow 1, and press down, arrow 2, until it engages.

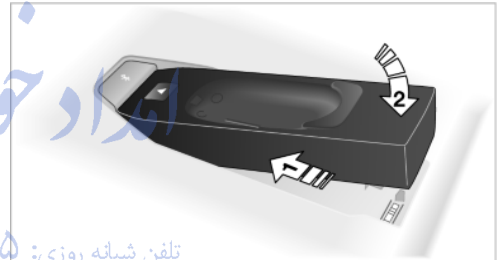

3. To remove the snap-in adapter: press button 1.

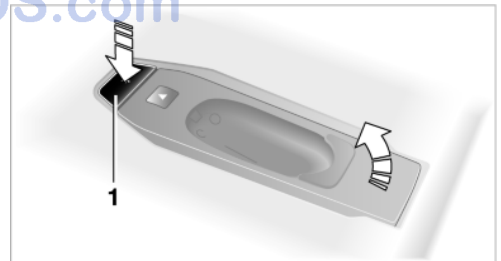

## Inserting the mobile phone

1. Depending on the mobile phone, remove the protective cap from the antenna connector and from the USB connection of the mobile phone.

2. With the buttons facing up, slide the mobile phone up toward the electrical contacts and press it down until it engages.

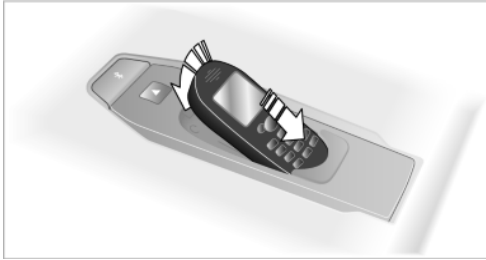

The battery is charged beginning with the radio ready state of the vehicle.

### Removing the mobile phone

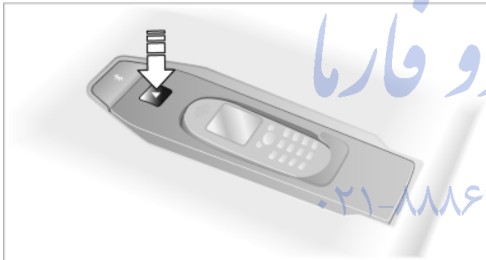

Press the button and remove the mobile phone.

امداد خودرو فارما  
تلفن شبانه روزی: ۰۸۵-۱۸۸۶۱-۲۱  
FarmaSOS.com



# ConnectedDrive

## Vehicle equipment

This chapter describes all series equipment as well as country-specific and special equipment offered for this model series. Therefore, it also describes equipment that may not be found in your vehicle, for instance due to the selected special equipment or the country version. This also applies to safety-related functions and systems.

## BMW Assist

### General information

BMW Assist provides you with certain services, e.g., transmission of the position data of your vehicle to the BMW Assist Response Center if an Emergency Request has been initiated.

Many BMW Assist services depend on the individually agreed upon contract.

After your contract has expired, the BMW Assist system will be deactivated by the BMW Assist Response Center without your having to visit a service center. After the BMW Assist system has been deactivated, no BMW Assist services will be available. The BMW Assist system can be reactivated by a service center after you sign a new contract.

### Requirements

- ▷ The installed BMW Assist system is logged in to a wireless communications network. This network must be capable of transmitting the services.
- ▷ To transmit position data, the vehicle must be able to determine the current position.
- ▷ The BMW Assist service contract was signed with your service center or with the BMW Assist Response Center. Enabling must have been completed.

- ▷ BMW Assist is activated.

### Services offered

- ▷ Emergency Request: when you press the SOS button, a connection to the BMW Assist Response Center is established. The BMW Assist Response Center then speaks with you and takes further steps to help you.
- ▷ Automatic Collision Notification: under certain conditions, a connection is established to the BMW Assist Response Center after a serious accident. If possible, the BMW Assist Response Center then speaks with you and takes further steps to help you.
- ▷ Enhanced Roadside Assistance: BMW Roadside Assistance can be contacted if assistance is needed in the event of a breakdown. If possible, the vehicle and position data are transmitted in the process.
- ▷ Customer Relations: connection with Customer Relations for information on all aspects of your vehicle.
- ▷ TeleService: data on your vehicle's service status or required inspections are transmitted to your service center, either automatically before a service due date or when you request a BMW service appointment.
- ▷ Remote Door Unlock: the BMW Assist Response Center provides assistance if, for example, the remote control is not available and the vehicle needs to be opened.
- ▷ Stolen Vehicle Recovery: after you report that your vehicle was stolen to the police, the BMW Assist Response Center can determine its position.
- ▷ In addition to these services, the optional Convenience Plan offers Concierge service and information for route planning, traffic, and weather. A limited number of calls can be made via the BMW Assist Response Center with Critical Calling if, for example,

the mobile phone is not available or discharged.

Press the SOS button to contact the BMW Assist Response Center.

## TeleService

### General information

TeleService supports communication with your service center.

- ▷ Data on the vehicle's service requirements can be sent directly to the service center. In this way, the service center can plan its work in advance. This shortens the duration of the service appointment.
- ▷ In the event of a breakdown, data on the vehicle's condition can be sent directly to Roadside Assistance.
- ▷ The service varies by country.
- ▷ Connection costs may ensue.
- ▷ Services may be restricted abroad.

### Requirements

- ▷ The vehicle is equipped with the BMW Assist and Bluetooth system.
- ▷ BMW Assist is activated.  
If BMW Assist is not activated, a mobile phone that has been recommended by BMW for TeleService and that is configured for mobile data communication must be connected with the vehicle.
- ▷ Wireless reception is available.
- ▷ The ignition is switched on.

### Using TeleService

The TeleServices are typically activated in the vehicle.

Even if the TeleServices are not active, a voice contact to Roadside Assistance is still possible.

To continue using or to deactivate the services, please contact your service partner or the BMW customer hotline.

## Activating or updating TeleServices or BMW Assist

To be able to use the services of TeleServices or BMW Assist, they must be activated.

1. Switch on the radio ready state or the ignition.
2.  Press the button.
3. "ASSIST"
4. "SET"
5. "SETUP"
6. "YES"

TeleServices and, if necessary, BMW Assist are activated and the data exchange with the service center can begin. Activation takes several minutes. The respective status is shown on the display.

## Concierge service

### General information

The BMW Assist Concierge service offers information on events, gas stations, and hotels, and provides phone numbers and addresses. Hotels can be booked directly by the BMW Assist Concierge service. The Concierge service is part of the optional Convenience Plan.

### Starting the Concierge service

1. Switch on the radio ready state or the ignition.
2.  Press the button.
3. "ASSIST"

4. "CONCIE"
5. Press the right knob to call the Concierge service.

### Reading messages

- Message was not read yet.

### Dialing a transferred phone number

1. Select the message and press the knob.
2. Select the phone number and press the knob.

### Deleting a message

1. Select the message and press the knob.
2. "DEL"

## Roadside Assistance

BMW Roadside Assistance can be contacted if assistance is needed in the event of a breakdown.

1. Switch on the radio ready state or the ignition.
2.  Press the button.
3. "ASSIST"
4. "RDASST"

Contact is established to Roadside Assistance. Roadside Assistance performs an in-depth diagnosis of the vehicle.

5. "ACCEPT"

Depending on the procedure Roadside Assistance uses to assist you, press the button.

## Automatic Service Request

The data regarding the maintenance status of your vehicle or pertaining to legally mandated inspections are automatically transmitted before a service due date.

## Manual service request

1. Switch on the radio ready state or the ignition.
2.  Press the button.
3. "ASSIST"
4. "SERV."

The data relevant to the service are transmitted. Your service center will contact you to arrange a service appointment.

## Customer Relations

Contact Customer Relations for information on all aspects of your vehicle.

1. Switch on the radio ready state or the ignition.
2.  Press the button.
3. "ASSIST"
4. "BMW"

## My Info

This service can be used to transmit text messages to the vehicle in conjunction with phone numbers via the BMW Assist Internet portal and to display these.

1. Switch on the radio ready state or the ignition.
2.  Press the button.
3. "ASSIST"
4. "MYINF"

The transmitted messages are displayed automatically.

5. To display an existing message: select the message and press the knob.

Up to ten messages can be displayed. If more messages are received, existing messages are deleted automatically.

### Reading messages

- ☑ Message was not read yet.

### Dialing a transferred phone number

If you received a message containing a phone number, you can forward it to your phone and dial the phone number.

1. Select the message and press the knob.
2. "CALL"

### Deleting a message

1. Select the message and press the knob.
2. "DEL"

## Services status

### Displaying the services

You are informed of any changes to the TeleServices or BMW Assist offer. In this case, you should update the services.

1. Switch on the radio ready state or the ignition.
2.  Press the button.
3. "ASSIST"
4. "SET"
5. "STATUS"
6. Turn the right knob to display the activated services.

## Displaying vehicle data

If TeleServices or BMW Assist is activated, you can have the vehicle identification number of your vehicle displayed.

1. Switch on the radio ready state or the ignition.
2.  Press the button.
3. "ASSIST"
4. "SET"
5. "PROFIL"

The BMW Assist profile of the vehicle is displayed.

امداد خودرو فارما

تلفن شبانه روزی: ۰۲۱-۸۸۸۶۲۰۸۵

FarmaSOS.com

# امداد خودرو فارما

تلفن شبانه روزی: ۰۲۱-۸۸۸۶۲۰۸۵

**FarmaSOS.com**



# امداد خود و فارما

تلفن شبانه روزی: ۰۲۱-۸۸۸۶۲۰۸۵

[FarmaSOS.com](http://FarmaSOS.com)

## Mobility

In order to always ensure your mobility, you will find important information on operating fluids, wheels and tires, maintenance and Roadside Assistance in the following.

امداد خودرو فارما

تلفن شماره روزی: ۰۲۱-۸۸۸۶۲۰۸۵

[FarmaSOS.com](http://FarmaSOS.com)

# Refueling

## Vehicle equipment

This chapter describes all series equipment as well as country-specific and special equipment offered for this model series. Therefore, it also describes equipment that may not be found in your vehicle, for instance due to the selected special equipment or the country version. This also applies to safety-related functions and systems.

## General information

**!** Refuel promptly  
At the latest, refuel at a range of 30 miles/50 km; otherwise, the engine function is not ensured and damage may occur. ◀

## Notes

**!** Switch off the engine before refueling  
Always switch off the engine before refueling; otherwise, fuel cannot be added to the tank and a message will be displayed. ◀

**!** Observe when handling fuel

- ▷ Take all precautionary measures and observe all applicable regulations when handling fuel.
- ▷ Do not carry any spare fuel containers in your vehicle. They can develop a leak and cause an explosion or cause a fire in the event of an accident. ◀

## Fuel filler flap

### Opening

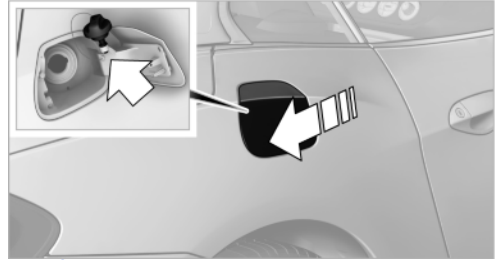

1. Briefly press the rear edge of the fuel filler flap.
2. Turn the fuel cap counterclockwise.
3. Place the fuel cap in the bracket attached to the fuel filler flap.

### Closing

Fit the fuel cap and turn it clockwise until you clearly hear a click.

**!** Do not pinch the retaining strap  
Do not pinch the retaining strap attached to the cap; otherwise, the cap cannot be closed properly and fuel vapors can escape. ◀



The warning lamp lights up briefly if the fuel cap is loose or missing. If this occurs, close the cap correctly.

### Manually unlocking fuel filler flap

In the event of a malfunction, you can release the fuel filler flap manually:



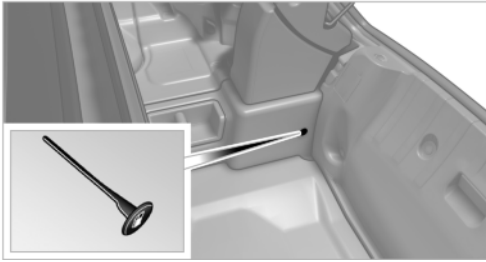

Pull the button in the trunk with the fuel pump symbol down. This releases the fuel filler flap.

### Observe the following when refueling



#### Handling fuels

Obey safety regulations posted at the gas station. ◀

When refueling, insert the filler nozzle completely into the filler pipe. Avoid lifting the filler nozzle while filling the tank, as that would lead to:

- ▶ Premature pump shutoff.
- ▶ Reduced efficiency of the fuel-vapor recovery system.

The fuel tank is full when the filler nozzle clicks off the first time.

### Fuel tank capacity

Approx. 14.5 gallons/55 liters.

FarmaSOS.com

# Fuel

## Vehicle equipment

This chapter describes all series equipment as well as country-specific and special equipment offered for this model series. Therefore, it also describes equipment that may not be found in your vehicle, for instance due to the selected special equipment or the country version. This also applies to safety-related functions and systems.

## Fuel quality

Do not use fuels that are labeled at the fuel pump as containing metals.

 Only refuel with lead-free gasoline without metal additives

Do not refuel with leaded gasoline or gasoline with metal additives, e. g., manganese or iron; otherwise, the catalytic converter and other components will be permanently damaged. ◀

 Do not refuel with ethanol E85  
Do not refuel with E85, i.e., fuel with an ethanol content of 85 %, or with Flex Fuel, as this would damage the engine and fuel supply system. ◀

## Required fuel

### Super Premium Gasoline/AKI 91

This gasoline is highly recommended.

### Gasoline with lower AKI

However, you may also use gasoline with less AKI.

The minimum AKI rating is: 89

If you use gasoline with this minimum AKI Rating, the engine may produce knocking sounds when starting at high outside temperatures.

This has no effect on the engine life.

 Minimum fuel grade  
Do not use any gasoline below the minimum specified fuel grade; otherwise, engine damage may occur. ◀

## Use high-quality brands

Field experience has indicated significant differences in fuel quality: volatility, composition, additives, etc., among gasolines offered for sale in the United States and Canada.

Fuels containing up to and including 10 % ethanol or other oxygenates with up to 2.8 % oxygen by weight, that is, 15 % MTBE or 3 % methanol plus an equivalent amount of co-solvent, will not void the applicable warranties with respect to defects in materials or workmanship.

 Minimum fuel grade  
The use of poor-quality fuels may result in driveability, starting and stalling problems especially under certain environmental conditions such as high ambient temperature and high altitude.

Should you encounter driveability problems which you suspect could be related to the fuel you are using, we recommend that you respond by switching to a recognized high-quality brand such as gasoline that is advertised as Top Tier Detergent Gasoline.

Failure to comply with these recommendations may result in unscheduled maintenance. ◀

**BMW** recommends BP fuels 

# Wheels and tires

## Vehicle equipment

This chapter describes all series equipment as well as country-specific and special equipment offered for this model series. Therefore, it also describes equipment that may not be found in your vehicle, for instance due to the selected special equipment or the country version. This also applies to safety-related functions and systems.

## Tire inflation pressure

### Information for your safety

It is not merely the tires' service life, but also driving comfort and, to a great extent, driving safety that depend on the condition of the tires and the maintenance of the specified tire pressure.

 Check the tire inflation pressure regularly. Regularly check the tire inflation pressure and correct it as needed: at least twice a month and before a long trip. If you fail to observe this precaution, you may be driving on tires with incorrect tire pressures, a condition that may not only compromise your vehicle's driving stability, but also lead to tire damage and the risk of an accident. ◀

### Checking the pressure

Only check the tire inflation pressure when the tires are cold. This means after a maximum of 1.25 miles/2 km driving or when the vehicle has been parked for at least 2 hours. When the tires are warm, the tire inflation pressure is higher.

After correcting the tire inflation pressure, reinitialize the Flat Tire Monitor, refer to page 75.

After correcting the tire inflation pressure, reset the Tire Pressure Monitor, refer to page 78.

## Pressure specifications

The tables below provide all the correct inflation pressures for the specified tire sizes at ambient temperature.

The inflation pressures apply to the tire sizes approved and tire brands recommended by BMW; a list of these is available from your service center.

For correct identification of the right tire inflation pressures, observe the following:

- ▷ Tire sizes of your vehicle.
- ▷ Maximum allowable driving speed.

### Tire inflation pressures for driving up to 100 mph or 160 km/h

For normal driving up to 100 mph/160 km/h, adjust pressures to the respective tire inflation pressures listed on the following pages in the column for traveling speeds up to 100 mph/160 km/h to achieve optimum driving comfort.

These tire inflation pressures can also be found on the driver's side door pillar when the driver's door is open.

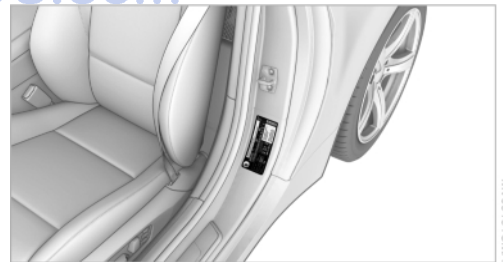

 Do not exceed the maximum permissible speed

The maximum permissible speed for these tire pressures is 100 mph/160 km/h. Do not exceed this speed; otherwise, tire damage and accidents could occur. ◀

### Tire inflation pressures for driving above 100 mph or 160 km/h



Adjust the tire inflation pressures

To drive at maximum speeds in excess of 100 mph/160 km/h, adjust pressures to the respective tire inflation pressures listed on the following pages in the column for traveling speeds

including those exceeding 100 mph or 160 km/h. Otherwise, tire damage and accidents could occur. ◀

Observe all national and local maximum speed limits; otherwise, violations of the laws could occur.

### Tire inflation pressures Z4 sDrive28i

Tire size	Pressure specifications in bar/PSI			
	Traveling speeds of up to 100 mph/160 km/h		Traveling speeds including those exceeding 100 mph/160 km/h	
All pressure specifications in the table are indicated in bar/psi with cold tires. Cold = ambient temperature				
Without Sport Package:				
225/45 R 17 91 V RSC	2.5/36	3.0/44	2.5/36	3.0/44
225/45 R 17 91 H M+S RSC	تلفن شبانه روزی: ۰۲۱-۸۸۸۶۲۰۸۵			
225/45 R 17 94 V M+S XL RSC				
Front: 225/45 R 17 91 V RSC	2.5/36	-	2.5/36	-
Rear: 255/40 R 17 94 V RSC	-	2.7/39	-	2.7/39
Front: 225/40 R 18 88 W RSC	2.5/36	-	2.5/36	-
Rear: 255/35 R 18 90 W RSC	-	2.9/42	-	2.9/42
Front: 225/35 R 19 88 Y XL RSC	2.5/36	-	2.5/36	-
Rear: 255/30 R 19 91 Y XL RSC	-	2.9/42	-	2.9/42
With Sport Package:				
225/45 R 17 91 W RSC	2.5/36	3.0/44	2.5/36	3.0/44
225/45 R 17 91 H M+S RSC				
225/45 R 17 94 V M+S XL RSC				
Front: 225/45 R 17 91 W RSC	2.5/36	-	2.5/36	-
Rear: 255/40 R 17 94 W RSC	-	2.7/39	-	2.7/39

Tire size	Pressure specifications in bar/PSI			
Front: 225/40 R 18 88 W RSC	2.5/36	-	2.6/38	-
Rear: 255/35 R 18 90 W RSC	-	2.9/42	-	3.1/45
Front: 225/35 R 19 88 Y XL RSC	2.5/36	-	2.5/36	-
Rear: 255/30 R 19 91 Y XL RSC	-	2.9/42	-	3.0/44

More details on the permissible load and weights, refer to page 204.

## Tire inflation pressures Z4 sDrive35i

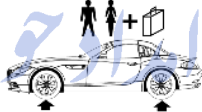
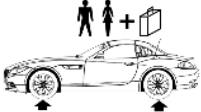
Tire size	Pressure specifications in bar/PSI			
	Traveling speeds of up to 100 mph/160 km/h		Traveling speeds including those exceeding 100 mph/160 km/h	
<p>All pressure specifications in the table are indicated in bar/psi with cold tires. Cold = ambient temperature</p> <div style="display: flex; justify-content: space-around; align-items: center;">   </div>				
Without Sport Package:				
225/45 R 17 91 H M+S RSC	2.5/36	3.0/44	2.5/36	3.0/44
225/45 R 17 94 V M+S XL RSC				
Front: 225/45 R 17 91 V RSC	2.5/36	-	2.5/36	-
Rear: 255/40 R 17 94 V RSC	-	2.7/39	-	2.7/39
Front: 225/40 R 18 88 W RSC	2.5/36	-	2.5/36	-
Rear: 255/35 R 18 90 W RSC	-	2.9/42	-	2.9/42
Front: 225/35 R 19 88 Y XL RSC	2.5/36	-	2.5/36	-
Rear: 255/30 R 19 91 Y XL RSC	-	2.9/42	-	2.9/42
With Sport Package:				
225/45 R 17 91 H M+S RSC	2.5/36	3.0/44	2.5/36	3.0/44
225/45 R 17 94 V M+S XL RSC				
Front: 225/45 R 17 91 W RSC	2.5/36	-	2.5/36	-
Rear: 255/40 R 17 94 W RSC	-	2.7/39	-	2.8/41
Front: 225/40 R 18 88 W RSC	2.5/36	-	2.7/39	-

Tire size	Pressure specifications in bar/PSI			
Rear: 255/35 R 18 90 W RSC	-	2.9/42	-	3.2/46
Front: 225/35 R 19 88 Y XL RSC	2.5/36	-	2.5/36	-
Rear: 255/30 R 19 91 Y XL RSC	-	2.9/42	-	3.0/44

More details on the permissible load and weights, refer to page 204.

### Tire inflation pressures Z4 sDrive35is

Tire size	Pressure specifications in bar/PSI			
	Traveling speeds of up to 100 mph/160 km/h		Traveling speeds including those exceeding 100 mph/160 km/h	

All pressure specifications in the table are indicated in bar/psi with cold tires.

Cold = ambient temperature

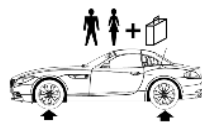
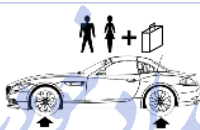

225/45 R 17 91 H M+S RSC	2.5/36	3.0/44	2.5/36	3.0/44
225/45 R 17 94 V M+S XL RSC				
Front: 225/40 R 18 88 W RSC	2.7/39	3.2/46	2.7/39	-
Rear: 255/35 R 18 90 W RSC	-	3.2/46	-	3.2/46
Front: 225/35 R 19 88 Y XL RSC	2.5/36	-	2.5/36	-
Rear: 255/30 R 19 91 Y XL RSC	-	3.0/44	-	3.0/44

More details on the permissible load and weights, refer to page 204.

### Tire identification marks

Knowledge of the labeling on the side of the tire makes it easier to identify and choose the right tires.

#### Tire size

Example: 225/45 R 17 91 V

225: nominal width in mm

45: aspect ratio in %

R: radial tire code

17: rim diameter in inches

91: load rating, not for ZR tires

V: speed rating, before the R on ZR tires

#### Speed letter

Q = up to 100 mph/160 km/h

T = up to 118 mph/190 km/h

H = up to 131 mph/210 km/h

V = up to 150 mph/240 km/h

W = up to 167 mph/270 km/h

Y = up to 186 mph/300 km/h

## Tire Identification Number

Tires with DOT codes meet the guidelines of the U.S. Department of Transportation.

DOT code:

DOT xxxx xxx 3311

xxxx: manufacturer code for the tire brand

xxx: tire size and tire design

3311: tire age

## Tire age

The tire manufacturing date is contained in the tire identification mark: DOT ... 3311 means that the tire was manufactured in the week 33 of 2011.

BMW recommends that you replace all tires after 6 years at most, even if some tires may last for 10 years.

## Uniform Tire Quality Grading

Quality grades can be found where applicable on the tire sidewall between tread shoulder and maximum section width. For example:

Treadwear 200 Traction AA

Temperature A

## DOT Quality Grades

Treadwear

Traction AA A B C

Temperature A B C

 All passenger car tires must conform to Federal Safety Requirements in addition to these grades. ◀

## Treadwear

The treadwear grade is a comparative rating based on the wear rate of the tire when tested under controlled conditions on a specified government test course. For example, a tire graded 150 would wear one and one-half (1 1/2) times as well on the government course as a tire graded 100. The relative performance of tires depends upon the actual conditions of their use,

however, and may depart significantly from the norm due to variations in driving habits, service practices and differences in road characteristics and climate.

## Traction

The traction grades, from highest to lowest, are AA, A, B, and C.

Those grades represent the tire's ability to stop on wet pavement as measured under controlled conditions on specified government test surfaces of asphalt and concrete. A tire marked C may have poor traction performance.

The traction grade assigned to this tire is based on straight-ahead braking traction tests, and does not include acceleration, cornering, hydroplaning, or peak traction characteristics.

## Temperature

The temperature grades are A, the highest, B, and C, representing the tire's resistance to the generation of heat and its ability to dissipate heat when tested under controlled conditions on a specified indoor laboratory test wheel. Sustained high temperature can cause the material of the tire to degenerate and reduce tire life, and excessive temperature can lead to sudden tire failure. The grade C corresponds to a level of performance which all passenger car tires must meet under the Federal Motor Vehicle Safety Standard No. 109. Grades B and A represent higher levels of performance on the laboratory test wheel than the minimum required by law.

 Temperature grade for this tire

The temperature grade for this tire is established for a tire that is properly inflated and not overloaded. Excessive speed, underinflation, or excessive loading, either separately or in combination, can cause heat buildup and possible tire failure. ◀

## RSC – Run-flat tires

The symbol identifying run-flat tires is a circle with the letters RSC on the sidewall, refer to page 161.

## M+S

Winter and all-season tires.

These have better winter properties than summer tires.

## XL

Designation for specially reinforced tires.

## Tire tread

### Summer tires

Do not drive with a tire tread depth of less than 0.12 in/3 mm.

There is an increased danger of hydroplaning if the tread depth is less than 0.12 in/3 mm.

### Winter tires

Do not drive with a tire tread depth of less than 0.16 in/4 mm.

Below a tread depth of 0.16 in/4 mm, tires are less suitable for winter operation.

### Minimum tread depth

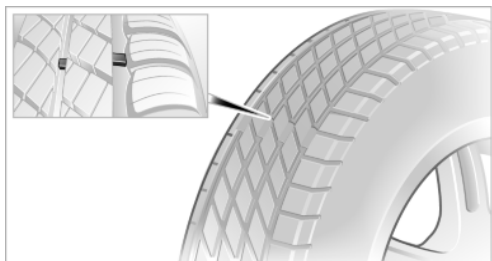

Wear indicators are distributed around the tire's circumference and have the legally required minimum height of 0.063 in/1.6 mm.

They are marked on the side of the tire with TWI, Tread Wear Indicator.

## Tire damage

Driving over rough or damaged road surfaces, as well as debris, curbs and other obstacles can cause serious damage to wheels, tires and suspension parts. This is more likely to occur with low-profile tires, which provide less cushioning between the wheel and the road. Be careful to avoid road hazards and reduce your speed, especially if your vehicle is equipped with low-profile tires.

Inspect your tires often for damage, foreign objects lodged in the tread, and tread wear.

Indications of tire damage or other vehicle defects:

- ▷ Unusual vibrations during driving.
- ▷ Unusual handling such as a strong tendency to pull to the left or right.



In case of tire damage

If there are indications of tire damage, reduce your speed immediately and have the wheels and tires checked right away; otherwise, there is the increased risk of an accident.

Drive carefully to the next service center or tire shop.

If necessary, have the vehicle towed. ◀



Repair of tire damage

For safety reasons, the manufacturer of your vehicle recommends that you do not have damaged tires repaired; they should be replaced. Otherwise, damage can occur as a result. ◀



## Run-flat tires

### Label



RSC label on the tire sidewall.

The wheels are composed of special rims and tires that are self-supporting, to a limited degree.

The support of the sidewall allows the tire to remain drivable to a restricted degree in the event of a pressure loss.

Driving can continue with a damaged tire, refer to page 77.

### Changing run-flat tires تلفن شماره روزی: ۰۸۵۲۰۸۸۶۲-۲۱

For your own safety, only use run-flat tires. No spare tire is available in the case of a flat tire. Your service center will be glad to advise you.

## Changing wheels and tires

### Mounting



Information on mounting tires

Have mounting and balancing performed only by a service center or tire specialist.

If this work is not carried out properly, there is the danger of subsequent damage and related safety hazards. ◀

### Wheel and tire combination

Information on the correct wheel-tire combination and rim versions for your vehicle can be obtained from your service center.

Incorrect wheel and tire combinations impair the function of a variety of systems such as ABS or DSC.

To maintain good handling and vehicle response, use only tires with a single tread configuration from a single manufacturer.

Following tire damage, have the original wheel and tire combination remounted on the vehicle as soon as possible.



Approved wheels and tires

The manufacturer of your vehicle recommends that you use only wheels and tires that have been approved for your particular vehicle model.

For example, despite having the same official size ratings, variations can lead to body contact and with it, the risk of severe accidents.

The manufacturer of your vehicle cannot evaluate non-approved wheels and tires to determine if they are suited for use, and therefore cannot ensure the operating safety of the vehicle if they are mounted. ◀

### Recommended tire brands

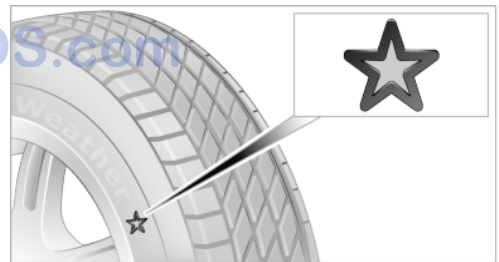

For each tire size, the manufacturer of your vehicle recommends certain tire brands. These can be identified by a star on the tire sidewall.

With proper use, these tires meet the highest standards for safety and handling.

### Retreaded tires

The manufacturer of your vehicle does not recommend the use of retreaded tires.



### Retreaded tires

Possibly substantial variations in the design and age of the tire casing structures can limit service life and have a negative impact on road safety. ◀

## Winter tires

The manufacturer of your vehicle recommends winter tires for winter roads or at temperatures below +45 °F/+7 °C.

Although so-called all-season M+S tires do provide better winter traction than summer tires, they do not provide the same level of performance as winter tires.

### Maximum speed of winter tires

If the maximum speed of the vehicle is higher than the permissible speed for the winter tires, then display a corresponding sign in the field of vision. You can obtain this sign from the tire specialist or from your service center.



### Maximum speed for winter tires

Do not exceed the maximum speed for the winter tires; otherwise, tire damage and accidents can occur. ◀

## Run-flat tires

For your own safety, only use run-flat tires. No spare tire is available in the case of a flat tire. Your service center will be glad to advise you.

## Rotating wheels between axles

The manufacturer of your vehicle advises against swapping wheels between the front and rear axles.

This can impair the handling characteristics.

Rotating the tires is not permissible when using different types of tires.

## Storage

Store wheels and tires in a cool, dry place with as little exposure to light as possible.

Always protect tires against all contact with oil, grease and fuels.

Do not exceed the maximum tire inflation pressure indicated on the side wall of the tire.

## Snow chains

Only certain fine-link snow chains have been tested by BMW, classified as safe for use and recommended. Consult your service center for more information.

Snow chains must be mounted in pairs and on the rear wheels only. Observe the manufacturer's instructions when mounting snow chains. Do not exceed a speed of 30 mph/50 km/h when using snow chains.

Do not initialize the Flat Tire Monitor if snow chains are mounted; otherwise, the instrument might issue an incorrect reading.

When driving with snow chains, it can be beneficial to temporarily activate DTC, refer to page 83.

FarmaSOS.com

# Engine compartment

## Vehicle equipment

This chapter describes all series equipment as well as country-specific and special equipment offered for this model series. Therefore, it also

describes equipment that may not be found in your vehicle, for instance due to the selected special equipment or the country version. This also applies to safety-related functions and systems.

## Important features in the engine compartment

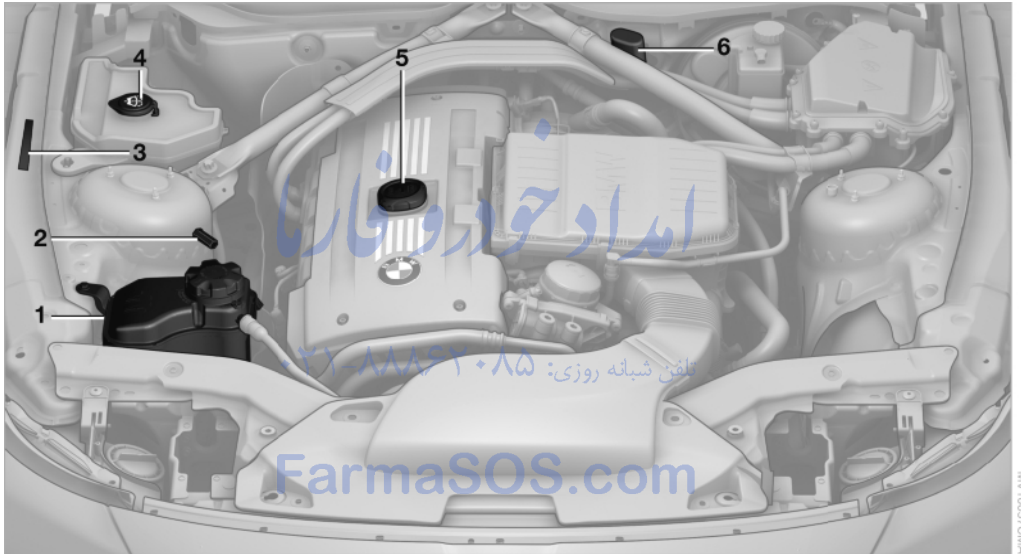

- |   |  |     |   |  |     |
|---|--|-----|---|--|-----|
| 1 | Coolant expansion tank   | 166 | 5 | Engine oil filler neck                   | 165 |
| 2 | Starting aid terminal, negative terminal                               | 178 | 6 | Starting aid terminal, positive terminal | 178 |
| 3 | Vehicle identification number  |     |   |  |     |
| 4 | Filler neck for washer fluid for the headlamp and window washer system | 52  |   |  |     |

# Hood

## Opening the hood

**!** Working in the engine compartment  
 Never attempt to perform any service or repair operations on your vehicle without the necessary professional technical training.

If you are unfamiliar with the statutory guidelines, have any work on the vehicle performed only by a service center.

If this work is not carried out properly, there is the danger of subsequent damage and related safety hazards. ◀

**!** To avoid damage, make sure that the wiper arms are resting against the windshield before you open the engine compartment. Do not open the engine hood before the engine has cooled down; otherwise, injuries may result. ◀

1. Pull the lever.

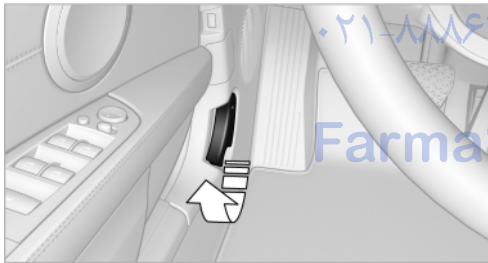

2. Push the release lever to the right and open the hood.

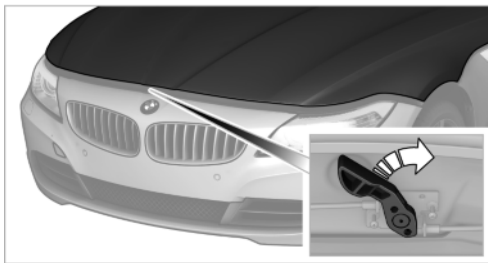

**!** Danger of injury when the hood is open  
 There is a danger of injury from protruding parts when the hood is open. ◀

## Closing the hood

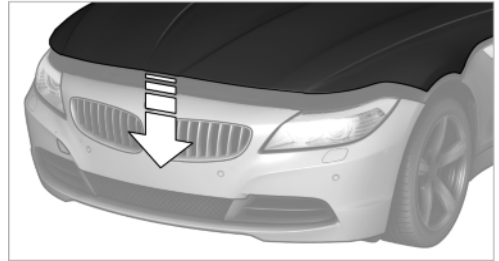

Close the hood from a height of approx. 16 in/ 40 cm with momentum. It must be clearly heard to engage.

**!** Hood open when driving  
 If you see any signs that the hood is not completely closed while driving, pull over immediately and close it securely. ◀

**!** Danger of pinching  
 Make sure that the closing path of the hood is clear; otherwise, injuries may result. ◀

## Checking the oil level

### The concept

Your car is equipped with an electronic engine oil level check.

### Requirements

- ▷ The engine must be running and warm after the vehicle has been driven for at least 6.2 miles/10 km.
- ▷ The vehicle is stopped or being driven on a level roadway.

## Display in the instrument cluster



1. Press button 1 in the turn indicator lever up or down repeatedly until the appropriate symbol appears in the display, accompanied by the word "OIL".
2. Press button 2 in the turn indicator lever. The oil level is checked and the reading displayed.

### Possible displays

 Too much engine oil  
Have the vehicle checked immediately; otherwise, surplus oil can lead to engine damage. ◀

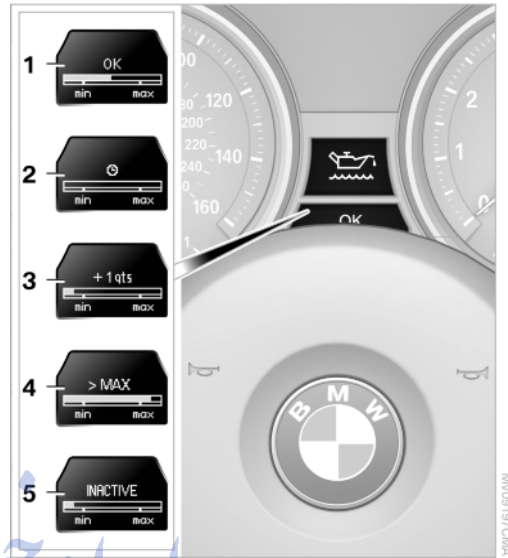

- 1 Oil level OK
- 2 Oil level is being checked. This can take about 3 minutes if the car is at a standstill on a level surface, or about 5 minutes while the car is on the move.
- 3 Oil level at minimum: add engine oil as soon as possible, but no more than 1 US quart / 1 liter.
- 4 Oil level is too high.
- 5 The oil level sensor is defective. Do not add engine oil. It is possible to continue driving. Note the newly calculated remaining mileage until the next oil service. Have the system checked as soon as possible.

### Adding engine oil

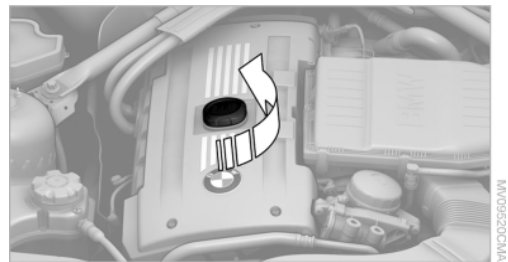

Depending on the engine, the filler neck is located in the middle, as shown, or at the front corner in the engine cover.

Add a maximum quantity of 1 US quart/1 liter of oil only after the following warning lamp lights up in the instrument cluster or the oil level monitor shows "+1qt" or "+1l".

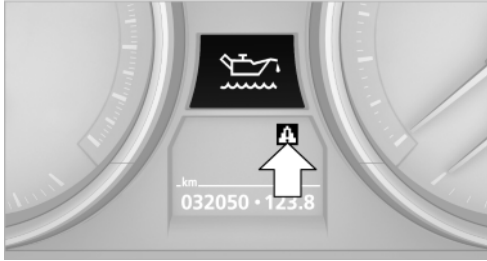

**!** Add oil promptly  
Add oil within the next 125 miles/200 km; otherwise, engine damage could result. ◀

**!** Protect children  
Keep oil, grease, etc., out of reach of children and heed the warnings on the containers to prevent health risks. ◀

### Oil types for refilling

#### Notes

**!** No oil additives  
Oil additives may lead to engine damage. ◀

**!** Viscosity classes of engine oils  
When selecting an engine oil, ensure that the engine oil belongs to one of the viscosity classes SAE 0W-40, SAE 0W-30, SAE 5W-40, or SAE 5W-30, or malfunctions or engine damage may occur. ◀

The engine oil quality is critical for the life of the engine.

Some oil types are not available in all countries.

### Approved oil types

#### Specification

BMW High Performance SAE 5W-30

BMW Longlife-01

BMW Longlife-01 FE

Further information on approved oil types can be obtained from the service center.

### Alternative oil types

If the approved engine oils are not available, up to 1 US quart/liter of an oil with the following specification can be used:

#### Specification

API SM or a higher quality standard

### Oil change

An oil change should be carried out by the service center only.

FarmaSOS.com

BMW recommends 

### Coolant

#### General information

**!** Danger of burns from hot engine  
Do not open the cooling system while the engine is hot; otherwise, escaping coolant may cause burns. ◀



### Suitable additives

Only use suitable additives; otherwise, engine damage may occur. The additives are harmful to your health. ◀

Coolant consists of water and additives.

Not all commercially available additives are suitable for your vehicle. Ask your service center for suitable additives.

## Checking the coolant level

1. Let the engine cool.
2. Turn the expansion tank cap counterclockwise slightly to allow any accumulated pressure to escape, then continue turning to open.
3. The coolant level is correct if it is between the maximum and minimum marks in the filler neck, refer also to the diagram next to the filler neck.

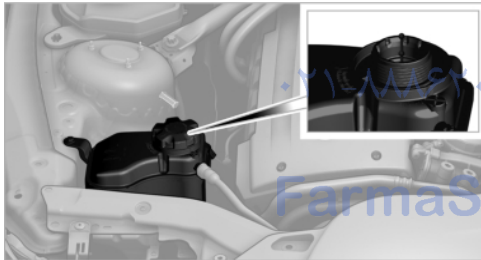

4. If the coolant is low, slowly add coolant up to the specified level; do not overfill.
5. Turn the cap until there is an audible click.
6. Have the cause of the coolant loss eliminated as soon as possible.

## Disposal



Comply with the appropriate environmental protection regulations when disposing of coolant additives.

# Maintenance

## Vehicle equipment

This chapter describes all series equipment as well as country-specific and special equipment offered for this model series. Therefore, it also describes equipment that may not be found in your vehicle, for instance due to the selected special equipment or the country version. This also applies to safety-related functions and systems.

## BMW Maintenance System

The maintenance system provides information on required maintenance measures and thus provides support in maintaining road safety and the operational reliability of the vehicle.

## Condition Based Service CBS

Sensors and special algorithms take into account the driving conditions of your vehicle. Based on this, Condition Based Service determines the maintenance requirements.

The system makes it possible to adapt the amount of maintenance you need to your user profile.

Details on the service requirements, refer to page 65, can be displayed on the instrument cluster.

## Service data in the remote control

Information on the required maintenance is continuously stored in the remote control. Your service center will read out this data and suggest the right array of service procedures for your vehicle.

Therefore, hand your service specialist the remote control that you used most recently.

## Storage periods

Storage periods during which the vehicle battery was disconnected are not taken into account.

If this occurs, have a service center update the time-dependent maintenance procedures, such as checking brake fluid and, if necessary, changing the engine oil and the microfilter/activated-charcoal filter.

## Service and Warranty Information Booklet for US models and Warranty and Service Guide Booklet for Canadian models

Please consult your Service and Warranty Information Booklet for US models and Warranty and Service Guide Booklet for Canadian models for additional information on service requirements. Maintenance and repair should be performed by your service center. Make sure to have regular maintenance procedures recorded in the vehicle's Service and Warranty Information Booklet for US models, and in the Warranty and Service Guide Booklet for Canadian models. These entries are proof of regular maintenance.



## Socket for OBD Onboard Diagnosis

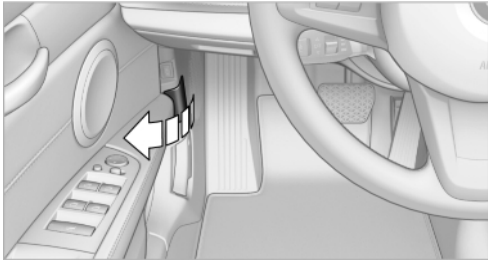

An OBD socket for testing components that are critical to exhaust composition is located under a cover on the driver's side.

stored in the remote control and can be read out with suitable devices, particularly when the vehicle is serviced. The data obtained in this way provide valuable information for service processes and repair or for optimizing and developing vehicle functions further. In addition, if you signed a service contract for Assist, certain vehicle data can be sent directly from the vehicle to facilitate the desired services.

## Emissions



- ▷ The warning lamp lights up:  
The emissions values are deteriorating. Have the vehicle checked as soon as possible.

- ▷ The warning lamp flashes under certain circumstances:

This indicates that there is excessive misfiring in the engine.

Reduce the vehicle speed and have the system checked immediately; otherwise, serious engine misfiring within a brief period can seriously damage emission control components, in particular the catalytic converter.



Display of the previously described malfunctions on Canadian models.

## Fuel cap



The indicator lamp lights up.

If the fuel cap is not properly tightened, the OBD system may conclude that fuel vapor is escaping. If the cap is then tightened, the display should go out in a short time.

## Data memory

Your vehicle records data relating to vehicle operation, faults and user settings. These data are

# Replacing components

## Vehicle equipment

This chapter describes all series equipment as well as country-specific and special equipment offered for this model series. Therefore, it also describes equipment that may not be found in your vehicle, for instance due to the selected special equipment or the country version. This also applies to safety-related functions and systems.

## Tool kit



The onboard vehicle tool kit is stored in a pouch under the trunk floor panel.

## Replacing the wiper blades

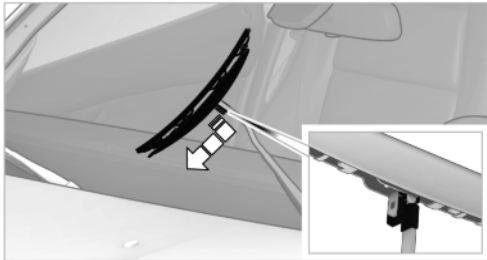

1. Fold up the wiper arm.
2. Fold the wiper blade upwards.

3. Press the hook.
4. Pull the wiper blade downward out of the holder and remove it toward the top left, see arrow.



Do not fold out the wiper arms

To avoid damage, make sure that the wiper arms are resting against the windshield before you open the engine compartment. ◀

## Lamp and bulb replacement

### General information

Lamps and bulbs make an essential contribution to vehicle safety.

The manufacturer of your vehicle recommends that you entrust corresponding procedures to your service center if you are unfamiliar with them or they are not described here.

You can obtain a selection of replacement bulbs at your service center.



Danger of burns

Only change bulbs when they are cool; otherwise, there is the danger of getting burned. ◀



Working on the lighting system

When working on the lighting system, you should always switch off the lights affected to prevent short circuits.

To avoid possible injury or equipment damage when replacing bulbs, observe any instructions provided by the bulb manufacturer. ◀



Do not touch the bulbs

Do not touch the glass of new bulbs with your bare hands, as even minute amounts of contamination will burn into the bulb's surface and reduce its service life.

Use a clean tissue, cloth or something similar, or hold the bulb by its base. ◀

### Light-emitting diodes LED

Light-emitting diodes installed behind translucent lenses serve as the light source for many of the controls and displays in your vehicle.

These light-emitting diodes, which operate using a concept similar to that applied in conventional lasers, are officially designated as Class 1 light-emitting diodes.



Do not remove the covers

Do not remove the covers, and never stare into the unfiltered light for several hours; otherwise, irritation of the retina could result. ◀

### Headlamp glass

Condensation can form on the inside of the external lamps in cool or humid weather. When you drive with the lights switched on, the condensation evaporates after a short time. The headlamp glasses do not need to be changed.

If the condensation in the headlamps does not evaporate after trips with the lights switched on, and the amount of moisture in the headlamps increases, for example if water droplets form, have them checked by your service center.

### Xenon headlamps

Because of the long life of these bulbs, the likelihood of failure is very low. Switching the lamps on and off frequently shortens their life.



Do not perform work/bulb replacement on xenon headlamps

Have any work on the xenon lighting system, including bulb replacement, performed only by a service center.

Due to the high voltage present in the system, there is the danger of fatal injuries if work is carried out improperly. ◀

### Parking lamps, roadside parking lamps, daytime running lights

H8 bulb, 35 watt

1. Switch off the lamps and take the remote control out of the ignition lock.
2. Turn the upper access cover to the left and remove it, see arrow.

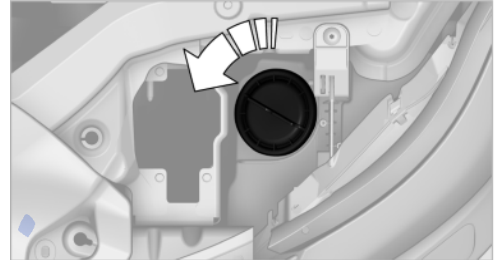

3. Turn the bulb by approx. 90°, see arrow 1, and pull it out, see arrow 2.

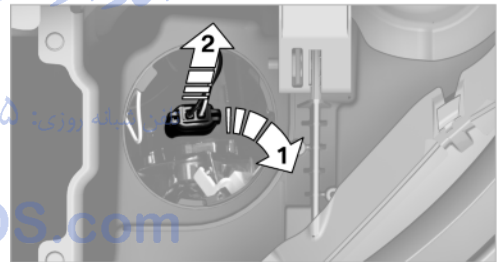

4. Disconnect the plug, change the bulb and reconnect the plug.
5. Insert the bulb and turn it until it stops.
6. Screw on the access cover tightly by turning it to the right.



Attach the access cover carefully

Be careful when attaching the access cover; otherwise, it may leak, causing damage to the headlamp system. ◀

### Turn signals, front

PY24W SV bulb, 24 watt

1. Turn the wheel outwards.



2. Turn both locks in the wheel house to the left and remove the cover.

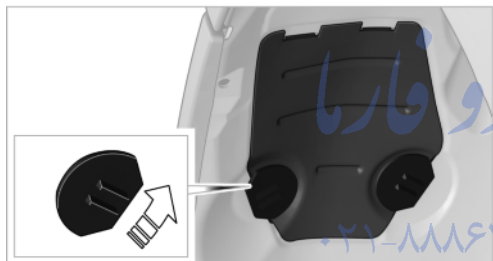

3. Turn the bulb holder to the left and remove it.
4. Turn the bulb to the right, see arrow, and remove it.

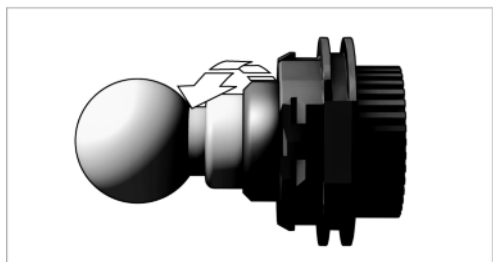

5. Change the bulb and screw it into the bulb holder toward the left.
6. Insert the bulb holder and turn it to the right.
7. Reattach the cover.

### Tail lamps

- ▷ Outer brake lamp, backup lamp: W16W bulb, 16 watt
- ▷ Inner brake lamp: H21W bulb, 21 watt

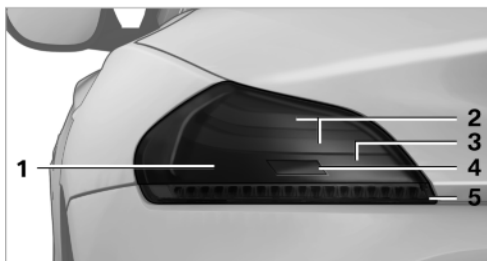

- 1 Outer brake lamp
- 2 Tail lamp, LED
- 3 Inner brake lamp
- 4 Backup lamp
- 5 Turn signal/dynamic brake lamp, LED

The lamps of bulbs 2 and 5 use LED technology. Follow the general instructions on lamps and bulbs, refer to page 170. Please contact your service center in the event of a malfunction.

### Changing the backup lamp and inner brake lamp



Press the locking mechanism in the trunk, see arrow, and remove the cover.

### Inner brake lamp

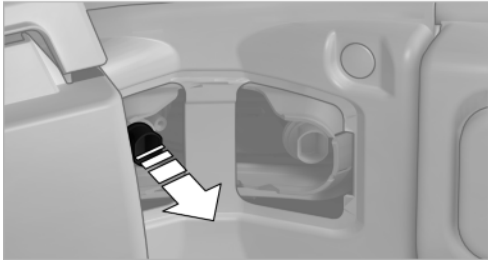

Pull out the bulb holder and replace the bulb.  
Fasten the bulb holder and attach the cover.

### Backup lamp

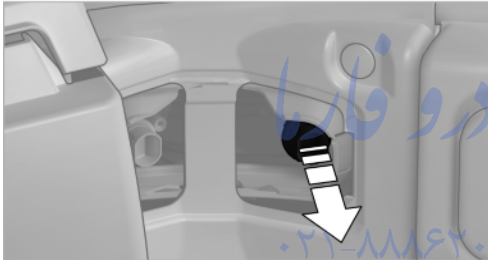

Pull out the bulb holder and replace the bulb.  
Fasten the bulb holder and attach the cover.

### Replacing the outer brake lamp

1. Remove the cover in the trunk.

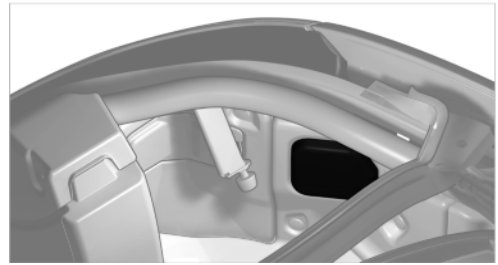

2. Pull out the bulb holder, see arrow, and change the bulb.

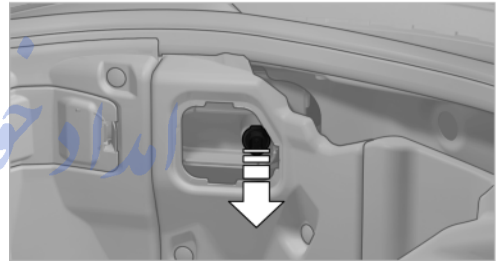

3. Attach the bulb holder.
4. Reattach the cover.

### License plate lamp, tail lamp, center brake lamp and turn signal

These lamps are made using LED technology.  
Please contact your service center in the event of a malfunction.

## Changing wheels

### Notes

Your vehicle is equipped with run-flat tires, refer to page 161, as standard equipment.

They do not need to be replaced immediately in the event of a puncture.

When mounting new tires or changing from summer to winter tires or vice versa, use run-flat tires for your own safety.

No spare tire is available in the case of a flat tire. The tools for changing wheels are available as accessories from your service center.

### Jacking points for the vehicle jack

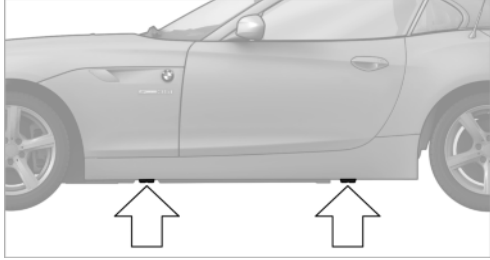

The jacking points for the vehicle jack are located in the positions shown.

### Lug bolt lock

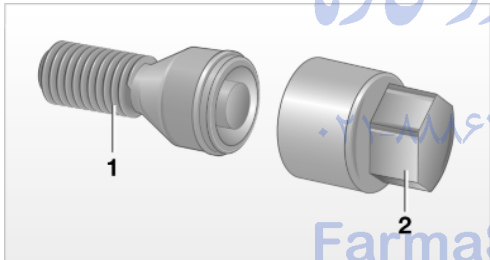

- 1 Lug bolt for adapter
- 2 Adapter, in onboard vehicle tool kit

### Removing

1. Attach adapter 2 to the wheel lug.
2. Unscrew lug bolt 1.

Remove the adapter after screwing the lug bolt back on.

## Vehicle battery

### Maintenance

The battery is maintenance-free, i.e., the electrolyte will last for the life of the battery.

Your service center will be glad to advise you on questions regarding the battery.

### Battery replacement



Use approved vehicle batteries.

Only use vehicle batteries that have been approved for your vehicle by the manufacturer; otherwise, the vehicle could be damaged and systems or functions may not be fully available. ◀

After a battery replacement, have the battery registered on the vehicle by your service center to ensure that all comfort functions are fully available.

### Charging the battery

#### Note



Do not connect the charger to the socket. Do not connect the battery charger to the socket installed in the vehicle at the factory as this could damage the vehicle. ◀

### Starting aid terminals

Only charge using the starting aid terminals, refer to page 178, in the engine compartment while the engine is switched off.

### Power failure

After a temporary power loss, some equipment needs to be reinitialized.

Individual settings need to be reprogrammed:

- ▷ Seat and mirror memory: store the positions again, refer to page 39.
- ▷ Time: update, refer to page 64.
- ▷ Date: update, refer to page 65.
- ▷ Radio station: store again, Professional Radio, refer to page 120.
- ▷ Interior rearview mirror with digital compass: recalibrate, refer to page 98.

## Disposing of old batteries



Have old batteries disposed of by your service center or bring them to a recycling center.

Maintain the battery in an upright position for transport and storage. Secure the battery so that it does not tip over during transport.

## Fuses

### Notes



Replacing fuses

Never attempt to repair a blown fuse and do not replace a defective fuse with a substitute of another color or amperage rating; this could lead to a circuit overload, ultimately resulting in a fire in the vehicle. ◀

A pair of plastic tweezers is found on the current distributor.

See the inside of the cover for information on fuse assignment.

### Below the glove box

1. Remove the screws 1 using the screwdriver from the onboard vehicle tool kit.
2. Remove cover 2, unwinding the cable to the footwell lamp if necessary.



3. Release the shiny fastener 3.

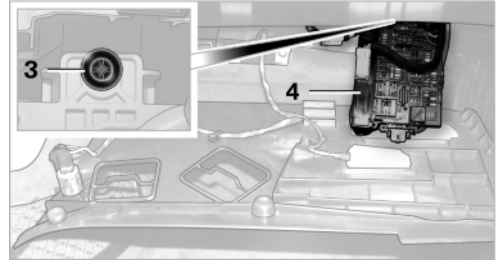

4. Fold the current distributor 4 downward and pull forward.

The cover is reinstalled in reverse order.

تلفن شبانه روزی: ۰۲۱-۸۸۸۶۲۰۸۵

FarmaSOS.com

# Breakdown assistance

## Vehicle equipment

This chapter describes all series equipment as well as country-specific and special equipment offered for this model series. Therefore, it also describes equipment that may not be found in your vehicle, for instance due to the selected special equipment or the country version. This also applies to safety-related functions and systems.

## Hazard warning system



The button for the hazard warning system is located on the center console.

## Emergency Request

### Requirements

- ▷ Equipment version with full preparation package mobile phone.  
An Emergency Request can be made, even if no mobile phones are paired with the vehicle.
- ▷ BMW Assist is activated.
- ▷ Radio ready state is activated.
- ▷ The BMW Assist system is logged in to a wireless communications network supported by BMW Assist.
- ▷ The Assist system is operable.

Only press the SOS button in an emergency.



Emergency Request not guaranteed

For technical reasons, the Emergency Request cannot be guaranteed under unfavorable conditions. ◀

### Service contract

- ▷ After your contract with BMW Assist has expired, the BMW Assist system can be deactivated by the service center without you having to visit a workshop.  
After deactivation, an Emergency Request is no longer possible.
- ▷ Under certain circumstances, the system can be reactivated by a service center after you sign a new contract.

### Initiating an Emergency Request

1. Briefly press the cover flap to open.



2. Press the SOS button until the LED in the button lights up.
  - ▷ The LED lights up: an Emergency Request was initiated.  
If the situation allows, wait in your vehicle until the voice connection has been established.
  - ▷ The LED flashes if the connection to the BMW Assist Response Center has been established.



After the Emergency Request arrives at the BMW Assist Response Center, the BMW Assist Response Center contacts you and takes further steps to help you.

Even if you are unable to respond, the BMW Assist Response Center can take further steps to help you under certain circumstances.

For this purpose, data that are used to determine the necessary rescue measures, such as the current position of the vehicle if it can be established, are transmitted to the BMW Assist Response Center.

- ▶ If the LED is flashing but the BMW Assist Response Center cannot be heard on the hands-free system, the hands-free system may be malfunctioning. However, the BMW Assist Response Center may still be able to hear you.

### Initiating an Emergency Request automatically

Under certain conditions, an Emergency Request is automatically initiated immediately after a severe accident. Automatic Collision Notification is not affected by pressing the SOS button.

### Warning triangle



The warning triangle is located in a holder in the trunk lid. Press the tabs to take it out.

### First aid kit

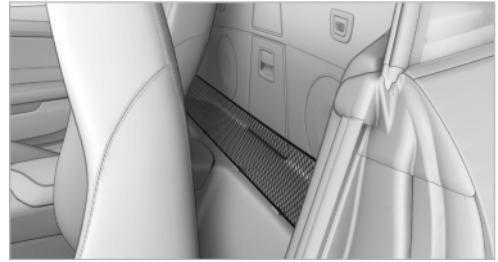

The first aid pouch is located on the lateral storage shelf behind the seats.

Some of the articles contained in the first aid pouch have a limited service life.

Check the expiration dates of the contents regularly and replace any items promptly.

### Roadside Assistance

#### Service availability

Roadside Assistance can be reached around the clock in many countries. You can obtain assistance there in the event of a vehicle breakdown.

### Jump-starting

#### Notes

If the battery is discharged, an engine can be started using the battery of another vehicle and two jumper cables. Only use jumper cables with fully insulated clamp handles.

To prevent personal injury or damage to both vehicles, adhere strictly to the following procedure.



Do not touch live parts

To avoid the risk of potentially fatal injury, always avoid all contact with electrical components while the engine is running. ◀

## Preparation

1. Check that the battery of the other vehicle has a voltage of 12 V. This information can be found on the battery.
2. Switch off the engine of the assisting vehicle.
3. Switch off any electronic systems/power consumers in both vehicles.



Bodywork contact between vehicles

Make sure that there is no contact between the bodywork of the two vehicles; otherwise, there is the danger of short circuits. ◀

## Starting aid terminals



Connecting order

Connect the jumper cables in the correct order; otherwise, there is the danger of injury from sparking. ◀

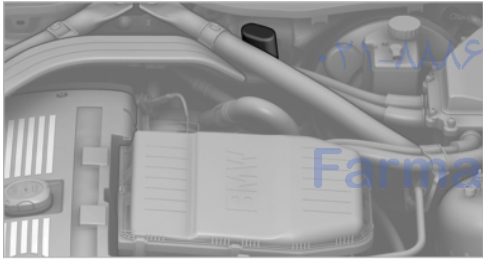

The so-called starting aid terminal in the engine compartment acts as the battery's positive terminal.

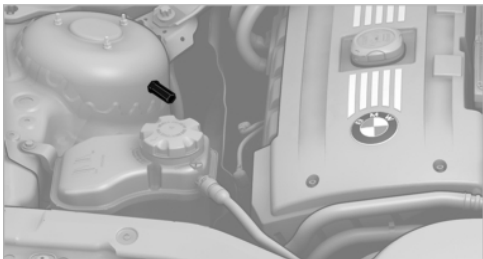

The body ground or a special nut acts as the negative terminal.

## Connecting jumper cables

1. Pull off the cap of the BMW starting aid terminal.
2. Attach one terminal clamp of the positive jumper cable to the positive terminal of the battery, or to the corresponding starting aid terminal of the vehicle providing assistance.
3. Attach the other end of the cable to the positive terminal of the battery, or to the corresponding starting aid terminal of the vehicle to be started.
4. Attach one terminal clamp of the negative jumper cable to the negative terminal of the battery, or to the corresponding engine or body ground of the vehicle providing assistance.
5. Attach the other end of the cable to the negative terminal of the battery, or to the corresponding engine or body ground of the vehicle to be started.

## Starting the engine

Never use spray fluids to start the engine.

1. Start the engine of the assisting vehicle and let it run for several minutes at an increased idle speed.  
If the vehicle being started has a diesel engine: let the engine of the assisting vehicle run for approx. 10 minutes.
2. Start the engine of the vehicle being started in the usual way.  
If the first starting attempt is not successful, wait a few minutes before making another attempt in order to allow the discharged battery to recharge.
3. Let both engines run for several minutes.
4. Disconnect the jumper cables in the reverse order.

Check the battery and recharge if necessary.

## Tow-starting and towing

### Tow fitting

The screw-in tow fitting should always be carried in the vehicle. It can be screwed in at the front or rear of the BMW.

It is stored in the onboard vehicle tool kit under the floor panel in the trunk, refer to page 170.



Tow fitting, information on use

- ▶ Use only the tow fitting provided with the vehicle and screw it all the way in.
- ▶ Use the tow fitting for towing on paved roads only.
- ▶ Avoid lateral loading of the tow fitting, e.g., do not lift the vehicle by the tow fitting.

Otherwise, damage to the tow fitting and the vehicle can occur. ◀

### Screw thread

#### Front

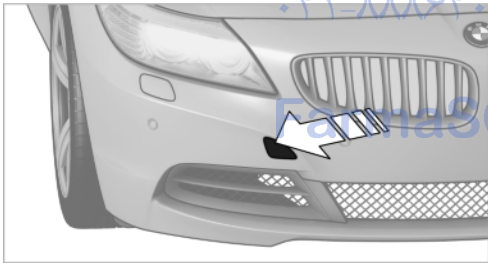

Release the cover panel in the bumper:

Press on the recess at the bottom left in the cover panel.

#### Rear

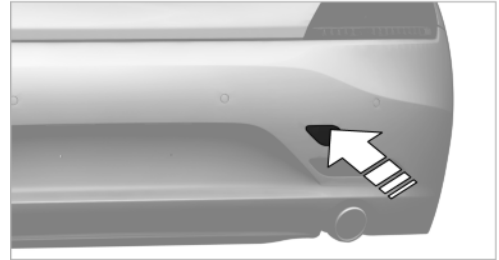

Release the cover panel in the bumper:

Press on the recess at the bottom center in the cover panel.

### Towing

#### General information



Light towing vehicle

The towing vehicle must not be lighter than the vehicle being towed; otherwise, it will not be possible to control the vehicle response. ◀



Attaching the tow bar/tow rope correctly

Attach the tow bar or tow rope to the tow fitting; connecting it to other vehicle parts may cause damage. ◀

#### 8-gear Sport automatic transmission

The vehicle is not permitted to be towed. Contact a service center in the event of a breakdown.



Observe in the event of a breakdown

Have the vehicle transported on a loading platform only, or damage may occur. ◀

#### Observe before towing



The parking brake is blocked

The parking brake cannot be released manually.

When the parking brake is blocked, do not tow with the front axle lifted or the vehicle can be damaged.

Contact your service center. ◀

### Manual transmission

Gearshift lever in neutral position.

### 7-gear Sport automatic transmission

 Manually release the transmission lock  
Manually release the transmission lock, even if there is no malfunction involving the transmission. Otherwise, there is the danger that the transmission lock will be engaged automatically during towing. ◀

Manually release the transmission lock, refer to page 58.

 Adhere to the towing speed and distance  
Do not exceed a towing speed of 30 mph/50 km/h and a towing distance of 30 miles/50 km or damage to the transmission can occur. ◀

### Observe during towing

 Observe the notes on towing  
Observe all notes on towing or vehicle damage or accidents can occur. ◀

- ▷ Make sure that the ignition is switched on; otherwise, the low beams, tail lamps, turn signals, and windshield wipers may be unavailable.
- ▷ When the engine is stopped, there is no power assist. Consequently, more force needs to be applied when braking and steering.
- ▷ Larger steering wheel movements are required.
- ▷ Switch on the hazard warning system, depending on local regulations.
- ▷ If the electrical system has failed, clearly identify the vehicle being towed by placing a sign or a warning triangle in the rear window.
- ▷ Do not tow the vehicle with the rear axle tilted, as the front wheels could turn.

### Towing methods

 Do not lift the vehicle  
Do not lift the vehicle by the tow fitting or body and chassis parts; otherwise, damage may result. ◀

### Tow bar

The tow fittings used should be on the same side on both vehicles.

Should it prove impossible to avoid mounting the tow bar at an offset angle, please observe the following:

- ▷ Clearance and maneuvering capability will be sharply limited during cornering.
- ▷ The tow bar will generate lateral forces if it is attached offset.

### Tow rope

When starting to tow the vehicle, make sure that the tow rope is taut.

To avoid jerking and the associated stresses on the vehicle components when towing, always use nylon ropes or nylon straps.

 Attaching the tow rope correctly  
Only secure the tow rope on the tow fitting; otherwise, damage can occur when it is secured on other parts of the vehicle. ◀

### Tow truck

 Do not lift the vehicle  
Do not lift the vehicle by the tow fitting or body and chassis parts; otherwise, damage may result. ◀

 Secure the vehicle against rolling off  
Apply the parking brake after towing and secure the vehicle against rolling off if necessary.

Have the operability of transmission position P checked by the service center. ◀

### Manual transmission

Have the BMW transported with a tow truck with a so-called lift bar or on a flat bed.

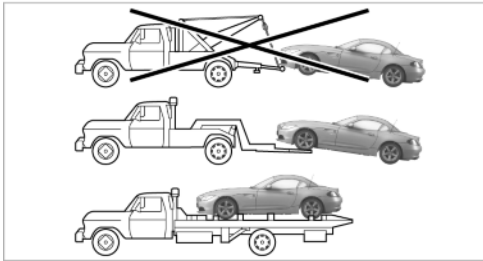

5. Stop at a suitable location, remove the tow bar or rope, and switch off the hazard warning system.
6. Have the vehicle checked.

### Sport automatic transmission

Have the BMW transported on a flat bed.

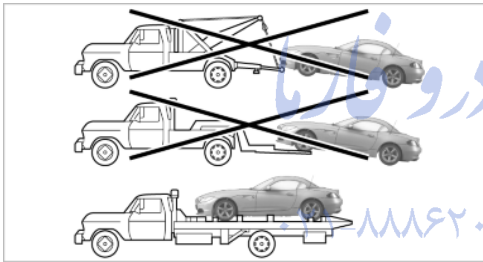

### Tow-starting

With the Sport automatic transmission, the engine cannot be started by tow-starting.

If possible, do not tow-start the vehicle but start the engine by jump-starting, refer to page 177, it. If the vehicle is equipped with a catalytic converter, only tow-start while the engine is cold.

1. Switch on the hazard warning system and comply with local regulations.
2. Switch on the ignition, refer to page 45.
3. Shift into 3rd gear.
4. Have the vehicle tow-started with the clutch pressed and slowly release the clutch. After the engine starts, immediately depress the clutch completely again.

# Care

## Vehicle equipment

This chapter describes all series equipment as well as country-specific and special equipment offered for this model series. Therefore, it also describes equipment that may not be found in your vehicle, for instance due to the selected special equipment or the country version. This also applies to safety-related functions and systems.

## Car washes

### Notes

 Steam jets or high-pressure washers  
When using steam jets or high-pressure washers, hold them a sufficient distance away and use a maximum temperature of 140 °F/ 60 °C.

Holding them too close or using excessively high pressures or temperatures can cause damage or preliminary damage that may then lead to long-term damage.

Follow the operating instructions for the high-pressure washer. ◀

 Cleaning sensors/cameras with high-pressure washers

When using high-pressure washers, do not spray the seals of the retractable hardtop and the exterior sensors and cameras, for Park Distance Control, for instance, for extended periods of time and only from a distance of at least 12 in/ 30 cm. ◀

Wash your vehicle frequently, particularly in winter.

Intense soiling and road salt can damage the vehicle.

## Washing in automatic car washes

Give preference to cloth car washes or those that use soft brushes in order to avoid paint damage.

### Notes

Note the following:

- ▶ Make sure that the wheels and tires are not damaged by the transport mechanisms.
- ▶ Fold in the exterior mirrors; otherwise, they may be damaged, depending on the width of the vehicle.
- ▶ Deactivate the rain sensor, refer to page 51, to avoid unintentional wiper activation.
- ▶ Unscrew the road antenna.

 Guide rails in car washes  
Avoid car washes with guide rails higher than 4 in/10 cm; otherwise, the vehicle body could be damaged. ◀

## Before driving into a car wash

The vehicle is able to roll if the following steps are taken.

### Manual transmission

1. Shift to neutral.
2. Release the parking brake, refer to page 49.
3. Switch the engine off.
4. Leave the remote control in the ignition lock.

### Sport automatic transmission

1. Insert the remote control into the ignition lock, even with Comfort Access.
2. Engage transmission position N.
3. Release the parking brake, refer to page 49.
4. Switch the engine off.
5. Leave the remote control in the ignition lock so that the vehicle can roll.

Transmission position P is engaged automatically:

- ▷ Automatically after approx. 30 minutes.
- ▷ When the remote control is removed from the ignition lock.

## Headlamps

- ▷ Do not rub dry and do not use abrasive or caustic cleansers.
- ▷ Soak areas that have been soiled e.g. due to insects, with shampoo and wash off with water.
- ▷ Thaw ice with de-icing spray; do not use an ice scraper.

## Retractable hardtop

When you open a wet hardtop, water drops may run into the cargo area. If necessary, remove items from the cargo area beforehand to avoid water stains or soiling.

## After washing the vehicle

After washing the vehicle, apply the brakes briefly to dry them; otherwise, braking action can be reduced and corrosion of the brake discs can occur.

## Vehicle care

### Car care products

BMW recommends using cleaning and care products from BMW, since these have been tested and approved.



Car care and cleaning products

Follow the instructions on the container.

When cleaning the interior, open the doors or windows.

Only use products intended for cleaning vehicles.

Cleansers can contain substances that are dangerous and harmful to your health. ◀

## Vehicle paint

Regular care contributes to driving safety and value retention.

Environmental influences can act on the vehicle paint. Tailor the frequency and extent of your car care to these influences.

## Leather care

Remove dust from the leather often, using a cloth or vacuum cleaner.

Otherwise, particles of dust and road grime chafe in pores and folds, and lead to increased wear and premature degradation of the leather surface.

To guard against discoloration, such as from clothing, provide leather care roughly every two months.

Clean light-colored leather more frequently as dust and dirt are more noticeable.

Use leather care products; otherwise, dirt and grease will gradually break down the protective layer of the leather surface.

Suitable care products are available from the service center.

## Upholstery material care

Vacuum regularly with a vacuum cleaner.

If they are very dirty, e.g., beverage stains, use a soft sponge or microfiber cloth with a suitable interior cleaner.

Clean the upholstery down to the seams using large sweeping motions. Avoid rubbing the material vigorously.



Damage from Velcro® fasteners

Open Velcro® fasteners on pants or other articles of clothing can damage the seat covers. Ensure that any Velcro® fasteners are closed. ◀

## Caring for special components

### Light-alloy wheels

Use wheel cleaner, particularly during the winter months. Do not use aggressive, acidic, strongly alkaline or abrasive cleaners, or steam jets above 140 °F/60 °C; follow the manufacturer's instructions.

### Chrome surfaces

Carefully clean components such as the radiator grille or door handles with an ample supply of water, possibly with shampoo added, particularly when they have been exposed to road salt.

### Rubber components

Aside from water, treat only with rubber cleansers.

When cleaning rubber seals, do not use any silicon-containing car care products in order to avoid damage or reduced noise damping.

### Fine wood parts

Clean fine wood facing and fine wood components only with a moist rag. Then dry with a soft cloth.

### Plastic components

These include:

- ▷ Imitation leather surfaces.
- ▷ Headliner.
- ▷ Lamp lenses.
- ▷ Instrument cluster cover.
- ▷ Matte black spray-coated components.
- ▷ Painted parts in the interior.

Clean with a microfiber cloth.

Moisten the cloth lightly with water if necessary.

Do not soak the headliner.

 Do not use cleansers that contain alcohol or solvents

Do not use cleansers that contain alcohol or solvents, such as lacquer thinners, heavy-duty

grease removers, fuel, or such; this could lead to surface damage. ◀

### Safety belts

Dirty belt straps impede the reeling action and thus have a negative impact on safety.



No chemical cleaning

Do not clean chemically; this can destroy the webbing. ◀

Use only a mild soapy solution, with the safety belts clipped into their buckles.

Do not allow the reels to retract the safety belts until they are dry.

### Carpets and floor mats



No objects in the area around the pedals

Keep floor mats, carpets, and any other objects out of the area of motion of the pedals; otherwise, the function of the pedals could be impeded while driving

Do not place additional floor mats over existing mats or other objects.

Only use floor mats that have been approved for the vehicle and can be properly fixed in place.

Ensure that the floor mats are securely fastened again when they are returned after being removed, such as for cleaning. ◀

Floor mats can be removed from the passenger compartment for cleaning.

When returning the floor mats, secure them again to prevent slipping.

If the floor carpets are very dirty, clean with a microfiber cloth and water or a textile cleaner. To prevent matting of the carpet, rub back and forth in the direction of travel only.



Cleaning the interior

When cleaning the interior, do not move both seats all the way forward while moving them to their uppermost position and leaning the backrests forward. Otherwise, the seats



could hit and damage the seal on the windshield and the sun visor. ◀

### Sensors/cameras

To clean the sensors or cameras of equipment such as the High-beam Assistant or Park Distance Control PDC, use a cloth moistened with a small amount of glass cleaner.

### Displays/screens

Use a microfiber cloth to clean the Control Display or instrument cluster, for example.



#### Cleaning displays

Do not use chemical or household cleaners.

Keep all fluids and moisture away from the unit.

Otherwise, they could affect or damage surfaces or electrical components.

Avoid pressing too hard when cleaning and do not use abrasive materials; otherwise, damage can result. ◀

### Long-term vehicle storage

Your service center can advise you on what to consider when storing the vehicle for longer than three months.

تلفن شبانه روزی: ۰۲۱-۸۸۸۶۲۰۸۵

FarmaSOS.com

# Indicator/warning lamps

## Vehicle equipment

This chapter describes all series equipment as well as country-specific and special equipment offered for this model series. Therefore, it also









describes equipment that may not be found in your vehicle, for instance due to the selected special equipment or the country version. This also applies to safety-related functions and systems.









## Overview



The indicator and warning lamps can light up in a variety of combinations and colors. See the table for information on causes and how to respond. Note whether a lamp comes on alone or in combination with another. Some lamps can light up in different colors. Corresponding distinctions are made in the text.

1	2	Cause	How to respond
		Turn signal	
		The high beams/headlamp flasher are switched on.	
		Fasten safety belts.	Fasten safety belt, refer to page 38.
BRAKE		Indication in US models	
		Lights up in red:	
		The parking brake is set.	Release the parking brake.
		Lights up in yellow:	
		Parking brake malfunctioning.	Have the system checked immediately.
PARK		Parking brake malfunctioning. Emergency braking with the parking brake not possible.	Have the system checked immediately.

1	2	Cause	How to respond
		Parking brake malfunctioning. Not functional while vehicle is stationary.	Secure vehicle against rolling when parked. Have the system checked immediately.
BRAKE PARK		Parking brake failed	Secure vehicle against rolling when parked. Have the system checked immediately.
(P)		Indication in Canadian models	
		Lights up in red: The parking brake is set.	Release the parking brake.
		Lights up in yellow: Parking brake malfunctioning.	Have the system checked immediately.
(P)		Parking brake malfunctioning. Emergency braking with the parking brake not possible.	Have the system checked immediately.
		Parking brake malfunctioning. Not functional while vehicle is stationary.	Secure vehicle against rolling when parked. Have the system checked immediately.
(!)		Parking brake failed	Secure vehicle against rolling when parked. Have the system checked immediately.
(P)			
		External temperature warning	Drive conservatively, refer to page 60.
		Lights up briefly: Approx. 2.1 US gal/8 liters of fuel remain in the tank. Remains on: The remaining range is no more than 30 miles/ 50 km, refer to page 61.	
		The engine refuses to start.	Depress the brake or clutch to start the engine, refer to page 46.



1	2	Cause	How to respond
		The ignition is switched on and driver's door is open.	Switch off the ignition, refer to page 45, or close the driver's door.
		To drive through automatic car washes, the transmission can be shifted to N. After approx. 30 minutes, the transmission automatically changes to P. The indicator lamp lights up just before the gear is changed automatically.	To keep the transmission in transmission position N, switch on the ignition.
		For some functions, the indicator lamp lights up if the desired function cannot be executed at the moment.	
		The parking lamps are still on.	Switch off the parking lamps, refer to page 68.
		The roadside parking lamps are still on	Switch off the roadside parking lamps, refer to page 70.
		A door is open.	
		The hood is open.	
		Lights up in red:	
		Roof activation system failure.	Roof cannot be moved. If the retractable hardtop does not lock, contact your nearest service center.
		The roof activation system is malfunctioning.	Roof movement incomplete. Please check if the roof is blocked, then press or pull the switch again.
		The roof is not locked.	Open the roof fully and close it again. Only continue driving after taking this measure.
		Lights up in yellow:	
		High temperature of roof motor.	Roof activation temporarily limited to closing only.

امداد خودرو فارما

تلفن شبانه روزی: ۰۲۱-۸۸۸۶۲۰۸۵

FarmaSOS.com

1	2	Cause	How to respond
		<p>The cargo area partition is not in the lower-most position.</p> <p>Roof activation only possible while vehicle is stationary.</p>	<p>Press down the cargo area partition until it engages on both sides.</p>
		<p>The vehicle is not level; roof activation is not possible.</p>	<p>Move the vehicle to a level surface.</p>
		<p>The trunk lid is open.</p>	
		<p>The fuel cap is missing or loose.</p>	<p>Make sure that the fuel cap is correctly positioned and close it until it clicks audibly. Do not jam the strap between the fuel cap and the vehicle.</p>
		<p>The windshield washer fluid level is too low.</p>	<p>Add washer fluid as soon as possible, refer to page 52.</p>
		<p>Lights up in red:</p> <p>Service is due.</p> <p>Lights up in yellow:</p> <p>The engine will start the next time the Start/ Stop button is touched, possibly without the brake or clutch being depressed</p>	<p>Arrange a service appointment.</p> <p>Check the service requirements, refer to page 65.</p>
		<p>The remote control is malfunctioning or, in cars with Comfort Access, was not detected.</p>	<p>The engine cannot be started. Have the remote control checked, if necessary.</p>
		<p>The battery in the remote control is discharged.</p>	<p>Use the remote control for a longer journey or, in cars with Comfort Access, replace the battery.</p>
		<p>The belt tensioners and/or airbag system has failed.</p>	<p>Have the system checked immediately.</p>



1	2	Cause	How to respond
		Lights up:	
			
		The Assist system has failed or is malfunctioning.	Have the system checked as soon as possible.
		Lights up in red:	
			
		Engine malfunction	Stop the car and switch off the engine. You cannot continue your journey. Contact your service center.
		Lights up in yellow:	
		Full engine power is no longer available.	You can continue your journey, but moderate your speed and exercise due caution. Have the engine checked as soon as possible.
		Indication in US models:	
		Warning lamp flashes:	
		Engine malfunction under high load. High engine load will result in damage to the catalytic converter.	You can continue your journey, but moderate your speed and exercise due caution. Have the vehicle checked immediately.
		Warning lamp comes on:	
		Engine malfunction with an adverse effect on exhaust emissions.	Have the vehicle checked as soon as possible.
		Indication in Canadian models:	
		Warning lamp flashes:	
		Engine malfunction under high load. High engine load will result in damage to the catalytic converter.	You can continue your journey, but moderate your speed and exercise due caution. Have the vehicle checked immediately.
		Warning lamp comes on:	

ایراد خودرو فارما

تلفن شبانه روزی: ۰۸۵ ۸۸۶۲۰۸۵  
FarmaSOS.com

SERVICE  
ENGINE  
SOON



1	2	Cause	How to respond
		Engine malfunction with an adverse effect on exhaust emissions.	Have the vehicle checked as soon as possible.
			
		Lights up in red:	
		The engine is overheating.	Carefully bring the car to a stop, switch off the engine and allow it to cool down. Do not open the hood; otherwise, there would be a risk of injury due to scalding. Contact your service center.
		Lights up in yellow:	
		The engine is too hot.	Continue driving at more moderate speed so that the engine can cool down. Have the engine checked without delay if the situation reoccurs.
			
		Lights up in red:	
		Battery is no longer being charged. Alternator malfunction.	Switch off all unnecessary electrical consumers. Have the power supply system checked without delay.
		Lights up in yellow:	
		The battery charge level is very low, the battery is old or is not securely connected.	Have the battery checked as soon as possible.
PARK		Indication in US models The parking brake is set.	
(P)		Indication in Canadian models The parking brake is set.	
BRAKE			
		Indication in US models	
		Lights up in red:	
		The brake fluid level is too low.	Reduced braking effect, stop the car carefully. Contact your service center.

1	2	Cause	How to respond
		Lights up in yellow: DBC failed. No power braking support during emergency braking.	You can continue your journey, but moderate your speed and exercise due caution. Have the system checked as soon as possible.
		Brake overheated	Allow the brake to cool down. You can continue your journey, but moderate your speed and exercise due caution.
		High brake load.	You can continue your journey, but moderate your speed and exercise due caution.



Indication in Canadian models

Lights up in red:

The brake fluid level is too low.

Reduced braking effect, stop the car carefully. Contact your service center.

Lights up in yellow:

DBC failed. No power braking support during emergency braking.

You can continue your journey, but moderate your speed and exercise due caution. Have the system checked as soon as possible.

The brake is overheating.

Allow the brake to cool down. You can continue your journey, but moderate your speed and exercise due caution.

High brake load.

You can continue your journey, but moderate your speed and exercise due caution.

BRAKE





Indication in US models



Brake pads worn.





Have the condition of the brake pads checked without delay.





1	2	Cause	How to respond
		Indication in Canadian models  Brake pads worn.	Have the condition of the brake pads checked without delay.
		Lights up in red:  The starter has failed.  Ignition malfunctioning. The engine can only be restarted when the brake is depressed.  Lighting system failed. Low beams/tail lamps and brake lights still operational. All other lamps failed.  Lights up in yellow:  Brake light control failed. The fuel supply is malfunctioning. Drive malfunctioning.	Have the system in question checked immediately.  The engine cannot be restarted.  Depress the brake to restart the engine.  You can continue your journey, but moderate your speed and exercise due caution. Have the system in question checked immediately.
		Flashing:  Dynamic Stability Control DSC or Dynamic Traction Control DTC is controlling drive and braking forces, refer to page 81.	
		Dynamic Traction Control DTC is activated, refer to page 82.	
		Dynamic Stability Control DSC and Dynamic Traction Control DTC are deactivated, refer to page 81.	Driving stability limited during acceleration and cornering.  Driving style must be readjusted.
		The suspension control system has failed, refer to page 81.	Driving stability limited during acceleration and cornering.  You can continue your journey, but moderate your speed and exercise due caution. Have the system checked as soon as possible.

1	2	Cause	How to respond
---	---	-------	----------------





BRAKE 		Indication in US models  Dynamic Stability Control DSC and DTC including drive-off assistant failed.	Driving stability limited during acceleration and cornering. You can continue your journey, but moderate your speed and exercise due caution. Have the system checked as soon as possible.
--	---	--	--











  		Indication in Canadian models  Dynamic Stability Control DSC and DTC including drive-off assistant and Flat Tire Monitor failed.	Driving stability limited during acceleration and cornering. You can continue your journey, but moderate your speed and exercise due caution. Have the system checked as soon as possible.
---	---	--	--



تلفن سپانه روزی: ۰۲۱-۸۸۸۶۲۰۸۵





ABS BRAKE 		Indication in US models  The driving stability control systems including ABS have failed, refer to page 81. Reduced braking and driving stability.	It is possible to continue driving. Drive at moderate speeds, avoiding abrupt braking maneuvers. Have the system checked as soon as possible.
---	---	--	---













FarmaSOS.com

ABS   		Indication in Canadian models	
--	---	-------------------------------	--

1	2	Cause	How to respond
		The driving stability control systems including ABS and the Flat Tire Monitor have failed, refer to page 81. Reduced braking and driving stability.	It is possible to continue driving. Drive at moderate speeds, avoiding abrupt braking maneuvers. Have the system checked as soon as possible.
ABS BRAKE 		Indication in US models	
		The vehicle electronics have failed.	You cannot continue your journey. Contact your service center.
ABS  		Indication in Canadian models	
		The vehicle electronics have failed.	You cannot continue your journey. Contact your service center.
		In vehicles with the Flat Tire Monitor Light up in yellow and red: A tire is deflated.	Carefully bring the car to a stop. Observe the additional information, refer to page 75.
		The Flat Tire Monitor was not initialized.	Initialize the Flat Tire Monitor, refer to page 75.
		Light up in yellow: Flat Tire Monitor failed. Punctures are not indicated.	Have the system checked.
		In vehicles with the Tire Pressure Monitor Light up in yellow and red:	
		There is a flat tire or substantial loss of inflation pressure in the indicated tire.	Carefully bring the car to a stop. Observe the additional information, refer to page 77.
		In vehicles with the Tire Pressure Monitor Light up in yellow:	

1	2	Cause	How to respond
		<p>Tire Pressure Monitor not initialized.</p> <p>The small lamp flashes yellow and then stays on, the large lamp lights up in yellow:</p> <p>Tire Pressure Monitor failed. Punctures are not indicated.</p> <p>Disturbance by systems or devices with the same radio frequency. After leaving the area of the disturbance, the system automatically becomes active again.</p>	<p>Check the inflation pressure and reset the system, refer to page 78.</p> <p>Have the system checked.</p>
		<p>In vehicles with the Tire Pressure Monitor</p> <p>The small lamp flashes yellow and then stays on, the large lamp lights up in yellow:</p> <p>Tire Pressure Monitor failed. Punctures are not indicated.</p> <p>A wheel without TPM electronics is mounted.</p>	<p>Have the system checked. Observe the additional information, refer to page 79.</p>
		<p>Lights up in yellow: transmission malfunction</p> <p>Malfunction in transmission position P.</p> <p>The gears that can be selected are restricted.</p> <p>Transmission limp-home program active with restricted range of gears, possibly with reduced acceleration.</p> <p>Gears can be engaged without depressing the brake.</p>	<p>Have the system checked immediately.</p> <p>When parking the vehicle, set the parking brake since transmission position P may be malfunctioning as well.</p> <p>It may be possible to correct the malfunction by restarting the engine.</p> <p>After switching off the engine, transmission position P is engaged automatically. It may not be possible to continue driving.</p> <p>You can continue your journey, but moderate your speed and exercise due caution. Have the system checked immediately.</p> <p>Always depress the brake to engage a gear.</p>

1	2	Cause	How to respond
		<p>Lights up in red:</p> <p>The transmission is overheating.</p> <p>Lights up in yellow:</p> <p>Manual transmission: the clutch temperature is too high.</p> <p>The automatic transmission is too hot.</p>	<p>Stop the car and engage transmission position P. Allow the transmission to cool down. You can continue your trip at moderate speeds. Have the system checked if the situation reoccurs.</p> <p>Allow the clutch to cool down. Cooling occurs while the vehicle is either stationary or moving. Avoid stop-and-go driving and driving below walking speed for lengthy periods. The clutch has cooled down when this message disappears. The clutch is not damaged.</p> <p>Avoid high engine loads. You can continue your journey, but moderate your speed and exercise due caution.</p>
		Transmission position P is not engaged. The vehicle is not secured against rolling.	
		The selector lever is malfunctioning.	The trip can be continued. Shift again if necessary. Have the system checked if the situation reoccurs.
		It is possible to engage the gear without depressing the brake.	To change the transmission position, always depress the brake.
		The pinch protection system of the power windows is malfunctioning.	Have the system checked.

1	2	Cause	How to respond
		<p>Cruise control deactivated:</p> <p>The driving stability control systems are active.</p> <p>The parking brake is set.</p> <p>The speed dropped below 20 mph/30 km/h.</p> <p>The engaged gear is not suitable for the speed being driven.</p>	
		The cruise control system has failed.	The trip can be continued. Have the system checked.
		The Park Distance Control has failed.	Have the system checked.
		A bulb of the exterior lighting system has failed.	Have the exterior lighting checked as soon as possible.
		A low-beam headlamp or front fog lamp has failed.	Have the low beams checked as soon as possible.
		A high-beam headlamp has failed.	Have the high-beam headlamps checked.
		The headlamp beam throw adjustment has failed.	Have the headlamp beam throw adjustment system checked.
		The adaptive light control has failed.	
		The coolant level is too low.	Add coolant immediately, refer to page 166.
		The engine oil pressure is too low.	Stop immediately and switch off the engine. You cannot continue your journey. Contact your service center.
		The engine oil level is too low.	Add engine oil immediately, refer to page 165.
		Lights up in red:	

1	2	Cause	How to respond
		<p>The service appointment is overdue.</p> <p>Lights up in yellow:</p> <p>Service is due.</p>	<p>Arrange a service appointment.</p> <p>Check the service requirements, refer to page 65.</p> <p>Arrange a service appointment.</p> <p>Check the service requirements, refer to page 65.</p>
		No service due.	Check the service requirements, refer to page 65.
		The time and date are no longer correct.	Set the time and date, refer to page 64.
		<p>Steering assistance has failed.</p> <p>Markedly different steering response.</p>	<p>You can continue your journey, but moderate your speed and exercise due caution. Have the system checked as soon as possible.</p>
		<p>Damping control is malfunctioning or has failed.</p> <p>Driving comfort is impaired.</p>	<p>You can continue your journey, but moderate your speed and exercise due caution. Have the system checked as soon as possible.</p>
		The engine was switched off by the Auto Start/Stop function.	To start the engine: press on the clutch pedal, refer to page 48.
		The Automatic Engine Start/Stop Function is deactivated.	<p>The Automatic Engine Start/Stop Function was deactivated using the button in the center console, refer to page 48. The engine will not be switched off or started automatically. To switch off/start the engine: press the Start/Stop button.</p>
		The Automatic Engine Start/Stop Function has failed.	<p>The engine will not be switched off or started automatically. Switch off or start the engine using the Start/Stop button. Have the system checked as soon as possible.</p>



# امداد خودرو فارما

تلفن شبانه روزی: ۰۲۱-۸۸۸۶۲۰۸۵

[FarmaSOS.com](http://FarmaSOS.com)



## Reference

This chapter contains the technical data and an index that will quickly take you to the information you need.

امداد خودرو فارما

تلفن شعبه فروش: ۰۲۱-۸۸۸۶۲۰۸۵

FarmaSOS.com

# Technical data

## Vehicle equipment

This chapter describes all series equipment as well as country-specific and special equipment offered for this model series. Therefore, it also

describes equipment that may not be found in your vehicle, for instance due to the selected special equipment or the country version. This also applies to safety-related functions and systems.

## Engine specifications

### Z4 sDrive28i

Displacement	cu in/cm <sup>3</sup>	122/1,997
No. of cylinders		4
Maximum output	hp	241
at engine speed	rpm	5,000
Maximum torque	lb ft/Nm	258/350
at engine speed	rpm	1,500 - 4,800

تلفن شبانه روزی: ۰۲۱-۸۸۸۶۲۰۸۵

### Z4 sDrive35i

Displacement	cu in/cm <sup>3</sup>	182/2,979
No. of cylinders		6
Maximum output	hp	300
at engine speed	rpm	5,800
Maximum torque	lb ft/Nm	300/407
at engine speed	rpm	1,400 - 5,000

### Z4 sDrive35is

Displacement	cu in/cm <sup>3</sup>	182/2,979
No. of cylinders		6
Maximum output	hp	335
at engine speed	rpm	5,900

Z4 sDrive35is

Maximum torque	lb ft/Nm	332/450
at engine speed	rpm	1,500

## Dimensions

### Z4 sDrive28i, Z4 sDrive35i

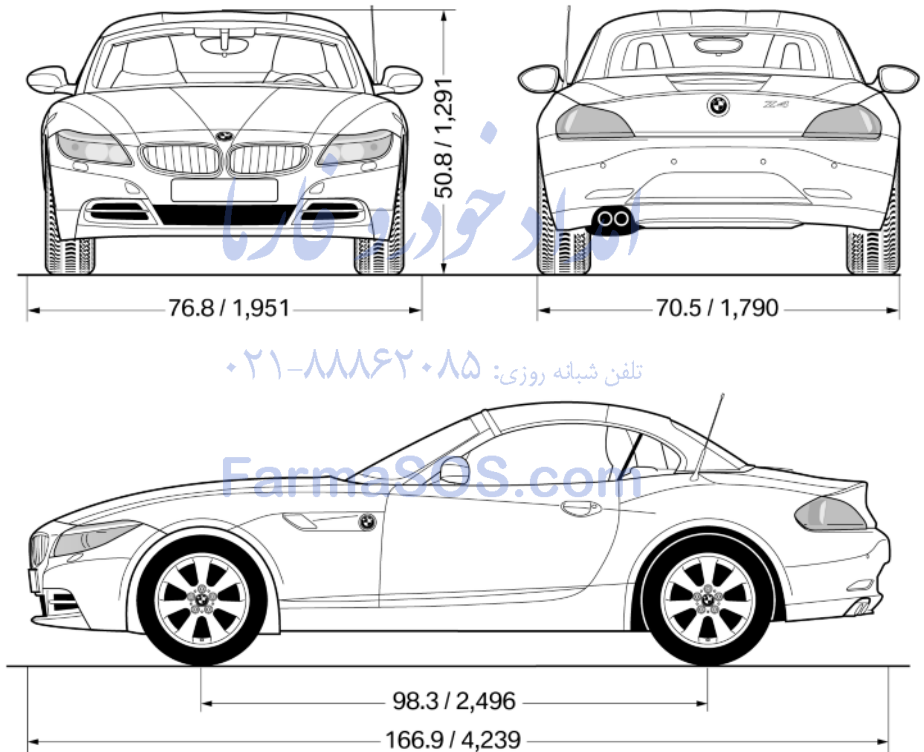

All dimensions given in inches/mm.

## Z4 sDrive35is

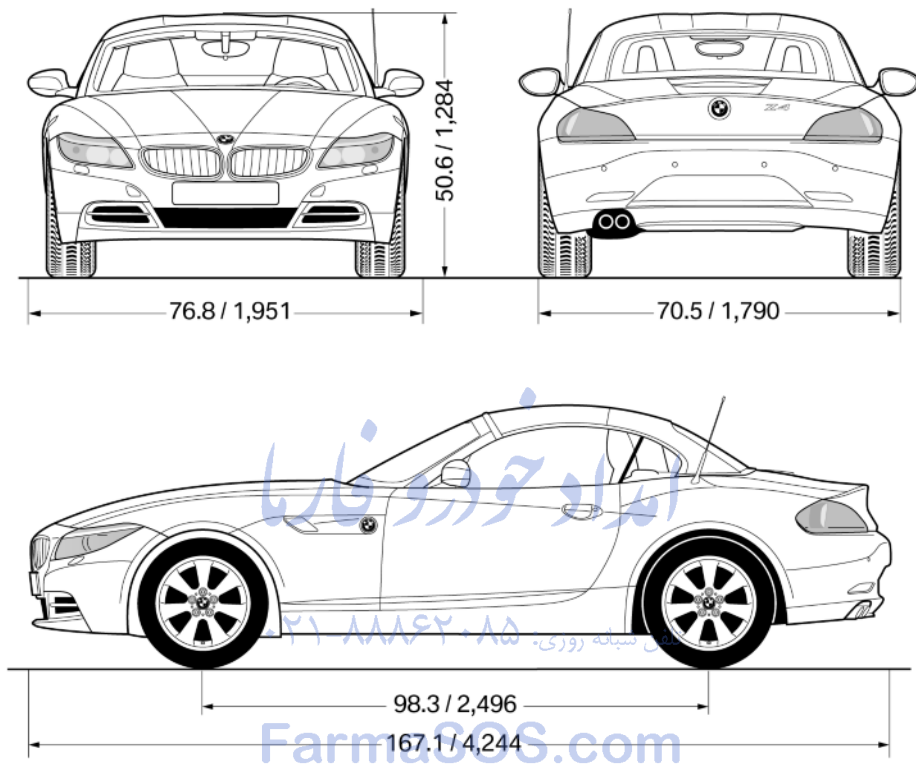

All dimensions given in inches/mm.

### Smallest turning circle

dia.: 35.1 ft/10.7 m

## Weights

### Z4 sDrive28i

Approved gross vehicle weight

Manual transmission	lbs/kg	3,858/1,750
With automatic transmission	lbs/kg	3,924/1,780

## Z4 sDrive28i

Load	lbs/kg	562/255
Approved front axle load	lbs/kg	1,742/790
Approved rear axle load	lbs/kg	2,227/1,010
Cargo area capacity	cu ft/l	6.4 - 10.9/180 - 310

## Z4 sDrive35i

## Approved gross vehicle weight

Manual transmission	lbs/kg	4,134/1,875
With automatic transmission	lbs/kg	4,178/1,895
Load	lbs/kg	562/255
Approved front axle load	lbs/kg	1,918/870
Approved rear axle load	lbs/kg	2,293/1,040
Cargo area capacity	cu ft/l	6.4 - 10.9/180 - 310

## Z4 sDrive35is

## Approved gross vehicle weight

Manual transmission	lbs/kg	—
With automatic transmission	lbs/kg	4,178/1,895
Load	lbs/kg	562/255
Approved front axle load	lbs/kg	1,918/870
Approved rear axle load	lbs/kg	2,293/1,040
Cargo area capacity	cu ft/l	6.4 - 10.9/180 - 310

## Capacities

			Notes
Fuel tank	US gal/liters	Approx. 14.5/55	Fuel quality, refer to page <a href="#">154</a>
Window washer system Including headlamp washers	US qt/liters	Approx. 6.3/6.0	Details, refer to page <a href="#">52</a>

امداد خودرو فارما

تلفن شبانه روزی: ۰۲۱-۸۸۸۶۲۰۸۵

FarmaSOS.com

# امداد خودرو فارما

تلفن شبانه روزی: ۰۲۱-۸۸۸۶۲۰۸۵

**FarmaSOS.com**

# Everything from A to Z

## Index

### A

- ABS, Antilock Brake System **81**
- Acceleration assistant, Launch Control **58**
- Accident, refer to Emergency Request, initiating **176**
- Activated charcoal filter with automatic climate control **95**
- Adaptive brake light, refer to Brake force display **80**
- Adaptive light control **70**
- Additives
  - Coolant **166**
  - Additives, oil **166**
- After washing vehicle **183**
- Airbags **73**
- Airbags
  - Indicator/warning lamps **75**
- Air circulation, refer to Recirculated air mode **90, 94**
- Air conditioner **90**
- Air conditioning mode
  - Air conditioner **90**
  - Automatic climate control **92**
  - Ventilation **91, 94**
- Air distribution
  - Automatic **93**
  - Individual **90**
  - Manual **90**
- Air flow rate **90, 93**
- Airing, refer to Ventilation **91, 94**
- Air outlets, refer to Air vents **89**
- Air pressure, refer to Tire inflation pressure **155**
- Air supply
  - Air conditioner **90**
  - Automatic climate control **92**
  - Ventilation **91, 94**
- Air vents **89**
- Air vents
  - Refer to Ventilation **91, 94**
- Alarm system **30**
- Alarm system
  - Avoiding unintentional alarms **31**
  - Ending an alarm **30**
  - Interior motion sensor **31**
  - Tilt alarm sensor **31**
- All around the headliner **16**
- All-season tires, refer to Winter tires **162**
- Alternating-code hand-held transmitter **97**
- Alternative oil types **166**
- Antifreeze
  - Coolant **166**
  - Washer fluid **52**
- Antilock Brake System, ABS **81**
- Anti-slip control, refer to DSC **81**
- Anti-theft protection **22**
- Anti-theft protection, lug bolts **174**
- Approved axle loads, refer to Weights **204**
- Approved engine oils **166**
- Approved gross vehicle weight, refer to Weights **204**
- Armrest, refer to Center armrest **103**
- Assist **145**
- Assistance, Roadside Assistance **177**
- Assistance systems, refer to Driving stability control systems **81**
- Assistance when driving off **84**
- Audio device, external **103**
- Automatic air distribution **93**
- Automatic air flow rate **93**
- Automatic car wash **182**
- Automatic climate control
  - Automatic air distribution **93**
- Automatic cruise control **85**
- Automatic Curb Monitor **40**
- Automatic Engine Start/Stop Function **47**
- Automatic headlamp control **69**
- Automatic recirculated air control **94**
- Automatic transmission
  - 7-gear with dual clutch **55**
  - 8-gear **53**
- AUTO program with automatic climate control **93**
- AUX-IN port **103, 127**
- Average fuel consumption **62**
- Average fuel consumption
  - Setting the units **63**
- Average speed **62**
- Axle loads, refer to Weights **204**

### B

- Backrest curvature, refer to Lumbar support **37**
- Backrests, refer to Seat adjustment **36**
- Backrest width adjustment **37**
- Backup lamps
  - Bulb replacement **172, 173**



- Band-aids, refer to First aid kit **177**
- Bar, refer to Towing methods **180**
- Battery
- Disposal **30, 175**
  - Power failure **174**
  - Remote control **20**
  - Replacement in the remote control **30**
  - Replacement, vehicle battery **174**
  - Vehicle **174**
- Before entering the car wash **182**
- Being towed **179**
- Belts, refer to Safety belts **38**
- Belt tensioners, refer to Safety belts **38**
- Beverage holder, refer to Cupholder **105**
- Blower, refer to Air flow rate **90, 93**
- BMW Assist **145**
- BMW Assist, refer to ConnectedDrive **145**
- BMW EfficientDynamics, refer to Saving fuel **112**
- BMW homepage **6**
- BMW Internet page **6**
- BMW Maintenance System **168**
- Bottle holder, refer to Cupholder **105**
- Brake assistant, refer to Dynamic Brake Control **81**
- Brake discs, breaking in **108**
- Brake force display **80**
- Brake force distribution, electronic **81**
- Brake lamps
- Brake force display **80**
  - Bulb replacement **172, 173**
- Brake lights, adaptive **80**
- Brake pads, breaking in **108**
- Brakes
- ABS **81**
- Braking
- Notes **109**
  - Parking brake **49**
  - Braking safely **109**
- Breakdown assistance **177**
- Breaking in **108**
- Bulbs, replacing, refer to Lamps and bulbs **170**
- Button for starting the engine, refer to Start/Stop button **45**
- Buttons on the steering wheel **12**
- Bypassing, see Starting aid **177**
- ## C
- California Proposition 65 Warning **7**
- Camera, care **185**
- Can holder, refer to Cupholder **105**
- Capacities
- Cargo area, refer to Weights **204**
  - Fuel tank, refer to Filling capacities **206**
- Car battery **174**
- Car care products **183**
- Care **182**
- Care, displays **185**
- Care, vehicle **183**
- Cargo **110**
- Cargo area
- Capacity **204**
  - Lamp, refer to Interior lamps **72**
  - Opening from the inside **27**
  - Opening from the outside **27**
- Cargo, securing **101**
- Cargo straps, securing cargo **112**
- Car key, refer to Integrated key/remote control **20**
- Carpet, care **184**
- Car phone
- Installation location, refer to Center armrest **103**
- Car vacuum cleaner, connecting, refer to Connecting electrical devices **100**
- Car wash **182**
- Car wash
- With Comfort Access **29**
- Catalytic converter, refer to Hot exhaust system **109**
- CBS Condition Based Service **168**
- CD/DVD changer **124**
- CD/DVD notes **126**
- Cell phone, installation location, refer to Center armrest **103**
- Center armrest **103**
- Center brake lamp
- Bulb replacement **173**
- Center console, refer to Around the center console **15**
- Central locking
- Comfort Access **28**
  - From the inside **26**
  - Setting the unlocking characteristics **22**
- Central locking system
- From the outside **21**
  - Principle **21**
- Changes, technical, refer to Safety **6**
- Changing wheels/tires **161**
- Chassis number, refer to Engine compartment **163**
- Check Control **66**
- Children, transporting safely **43**
- Child restraint fixing system **43**
- Child seats, refer to Transporting children safely **43**
- Chrome parts, care **184**
- Circulation of air, refer to Recirculated air mode **90, 94**

- Cleaning, displays **185**  
 Cleaning your BMW, refer to  
   Care **182**  
 Clock **60**  
 Clock  
   – 12h/24h format **63**  
 Closing  
   – From the inside **26**  
   – From the outside **22**  
 Cockpit **12**  
 Cold start, refer to Starting the  
   engine **46**  
 Combination instrument, refer  
   to Instrument cluster **14**  
 Combination switch  
   – Refer to Washer/wiper sys-  
   tem **51**  
 Comfort Access  
   – Battery replacement **30**  
   – In a car wash **29**  
 Comfort area, refer to Around  
   the center console **15**  
 COMFORT program, Dynamic  
   Driving Control **83**  
 Compartment for remote con-  
   trol, refer to Ignition lock **45**  
 Compartments, refer to Stor-  
   age compartments **104**  
 Compass **98**  
 Computer **62**  
 Computer  
   – Displays on the radio dis-  
   play **62**  
 Condensation under the vehi-  
   cle **110**  
 Condition Based Service  
   CBS **168**  
 Confirmation signals for lock-  
   ing/unlocking the vehicle **24**  
 ConnectedDrive **145**  
 Consumption, refer to Aver-  
   age fuel consumption **62**  
 Control Display, care **185**  
 Controls and displays **12**  
 Control systems, driving sta-  
   bility **81**  
 Convenient loading **23**  
 Convenient opening and clos-  
   ing  
   – Retractable hardtop **23**  
   – Window **23**  
 Convenient operation **26**  
 Convertible  
   – Enlarging the trunk **34, 100**  
 Convertible top, refer to Re-  
   tractable hardtop **33**  
 Coolant  
   – Checking the level **167**  
   – Temperature **61**  
 Cooling, maximum **93**  
 Cooling system, refer to Cool-  
   ant **166**  
 Corrosion on brake discs **110**  
 Courtesy lamps, refer to Inte-  
   rior lamps **72**  
 Cradle for telephone or mobile  
   phone  
   – Refer to Snap-in adapter in  
   center armrest storage com-  
   partment **103**  
 Cradle for telephone or mobile  
   phone, refer to Snap-in  
   adapter **143**  
 Cruise control **85**  
 Cruise control  
   – Malfunction **86**  
 Cupholder **105**  
 Curb weight, refer to  
   Weights **204**  
 Cylinders, number of, refer to  
   Engine data **202**
- D**
- Damage, tires **160**  
 Dashboard lighting, refer to In-  
   strument lighting **71**  
 Dashboard, refer to Cock-  
   pit **12**  
 Data, technical **202**  
 Data, technical  
   – Dimensions **203**  
   – Engine **202**  
   – Filling capacities **206**  
   – Weights **204**  
 Date  
   – Setting **65**  
 Daytime running lights **69**  
 DBC Dynamic Brake Con-  
   trol **81**  
 DCC, refer to Cruise con-  
   trol **85**  
 Defogging windows **91**  
 Defroster  
   – Rear window **91, 94**  
 Defrosting windows **91**  
 Digital clock **60**  
 Digital compass **98**  
 Dimming mirrors **41**  
 Directional indicators, refer to  
   Turn signals **50**  
 Displacement, refer to Engine  
   data **202**  
 Display lighting, refer to Instru-  
   ment lighting **71**  
 Displays and controls **12**  
 Displays, care **185**  
 Displays, cleaning **185**  
 Displays, refer to Instrument  
   cluster **14**  
 Disposal  
   – Coolant **166**  
   – Remote control battery **30**  
   – Vehicle battery **175**  
 Distance control, refer to  
   PDC **87**  
 Door key, refer to Remote con-  
   trol with integrated key **20**  
 Door lock **25**  
 Doors, manual operation **26**  
 Doors, unlocking and locking  
   – Confirmation signals **24**  
   – From the inside **26**  
   – From the outside **22**  
 DOT Quality Grades **159**  
 Draft-free ventilation **91, 95**  
 Drive-off assistant **84**  
 Drive-off assistant, refer to  
   DSC **81**  
 Driving notes, breaking in **108**  
 Driving notes, general **108**

Driving stability control systems **81**  
 Driving tips **108**  
 DSC Dynamic Stability Control **81**  
 DTC Dynamic Traction Control **82**  
 Dynamic Brake Control  
 DBC **81**  
 Dynamic Driving Control **82**  
 Dynamic Stability Control  
 DSC **81**  
 Dynamic Traction Control  
 DTC **82**

**E**

EBV electronic brake-force distribution **81**  
 EfficientDynamics, refer to  
 Saving fuel **112**  
 Electrical fault  
 – 7-gear automatic transmission **58**  
 Electrical malfunction  
 – Door lock **26**  
 – Driver's door **26**  
 – Fuel filler flap **152**  
 Electric seat adjustment **37**  
 Electronic brake-force distribution **81**  
 Electronic engine oil level check **164**  
 Electronic Stability Program  
 ESP, refer to DSC **81**  
 Emergency operation  
 – Fuel filler flap, unlocking manually **152**  
 Emergency Request **176**  
 Emergency service, refer to  
 Roadside Assistance **177**  
 Emergency unlocking  
 – Trunk lid, from the inside **28**  
 Energy, saving  
 – Automatic Engine Start/Stop Function **47**  
 Engine compartment **163**

Engine coolant, refer to Coolant **166**  
 Engine data **202**  
 Engine oil, adding **165**  
 Engine oil additives **166**  
 Engine oil, checking the level **164**  
 Engine oil, filling capacity **206**  
 Engine oil temperature **61**  
 Engine oil types, alternative **166**  
 Engine oil types, approved **166**  
 Engine, overheating, refer to  
 Coolant temperature **61**  
 Engine power, refer to Engine data **202**  
 Engine, RPM **202**  
 Engine start, Help **177**  
 Engine, starting **46**  
 Engine, starting  
 – Comfort Access **28**  
 – Start/Stop button **45**  
 Engine, stopping, Start/Stop button **45**  
 Engine, switching off **46**  
 Engine temperature **61**  
 Entry lamps, refer to Interior lamps **72**  
 Equipment, interior **96**  
 Error messages, refer to  
 Check Control **66**  
 ESP Electronic Stability Program, refer to DSC **81**  
 Exchanging wheels/tires **161**  
 Exhaust system **109**  
 Exterior mirrors **40**  
 Exterior mirrors  
 – Automatic dimming **41**  
 – Automatic heating **41**  
 – Folding in and out **41**  
 – Setting **40**  
 External audio device **103**  
 External start **177**  
 External temperature display **60**

External temperature display  
 – Changing the units **63**  
 – On the computer **63**  
 External temperature warning **60**  
 Eyes for securing cargo **112**

**F**

Failure messages, refer to  
 Check Control **66**  
 Failure of an electrical accessory **175**  
 False alarm  
 – Avoiding unintentional alarms **31**  
 – Ending an alarm **30**  
 Fastening safety belts, refer to  
 Safety belts **38**  
 Fasten safety belts reminder  
 – Refer to Safety belt reminder **39**  
 Filter  
 – Refer to Microfilter/activated-charcoal filter with automatic climate control **95**  
 – Refer to Microfilter for air conditioner **91**  
 Fine wood, care **184**  
 First aid kit **177**  
 Fittings  
 – For tow-starting and towing **179**  
 Flashing when locking/unlocking **24**  
 Flat tire, Flat Tire Monitor  
 FTM **75**  
 Flat Tire Monitor  
 – Snow chains **162**  
 Flat Tire Monitor FTM **75**  
 Flat tire, Tire Pressure Monitor  
 TPM **77**  
 Flat tire, warning lamp **76**  
 Flat tire, wheel change **173**  
 Flooding **109**  
 Floor carpet, care **184**  
 Floor mats, care **184**  
 Foot brake **109**

Footwell lamps, refer to Interior lamps **72**

For your own safety **6**

Front airbags **73**

FTM Flat Tire Monitor **75**

Fuel

- Refer to Average fuel consumption **62**

Fuel, average consumption **62**

Fuel consumption display

- Average fuel consumption **62**

Fuel display **61**

Fuel filler flap

- Unlocking in case of an electrical malfunction **152**

Fuel gauge **61**

Fuel quality **154**

Fuel tank capacity, refer to Filling capacities **206**

Fuel tank contents, refer to Filling capacities **206**

Fuses **175**

## G

Garage door opener, refer to Universal Garage Door Opener **96**

Gasoline **154**

Gasoline display **61**

Gear display

- 7-gear automatic transmission **55**
- 8-gear automatic transmission **55**

General driving notes **108**

Glove compartment **103**

Grilles, refer to Air vents **89**

Gross vehicle weight, refer to Weights **204**

## H

Handbrake, refer to Parking brake **49**

Hand-held transmitter, alternating code **97**

Hands-free microphone **15**

Hardtop **33**

Hazard warning system **15**

Head airbags **73**

Headlamp control, automatic **69**

Headlamp courtesy delay feature **68**

Headlamp flasher **50**

Headlamps, care **183**

Headlamps, cleaning **51**

Headliner **16**

Heating **89**

Heating

- Mirrors **41**
- Rear window **91, 94**
- Seats **38**

Heavy cargo, stowing **111**

Height adjustment

- Seats **36**
- Steering wheel **42**

Height, refer to Dimensions **203**

High-beam Assistant **71**

High beams **70**

High beams/low beams, refer to High-beam Assistant **71**

High beams, headlamp flasher **70**

High-pressure washers **182**

Hills **110**

Hill start assistant, refer to Drive-off assistant **84**

Holder for beverages **105**

Holder for remote control, refer to Ignition lock **45**

Homepage **6**

Hood **164**

Horn **12**

Hot exhaust system **109**

Hydroplaning **109**

Ice warning, refer to External temperature warning **60**

Icy roads, refer to External temperature warning **60**

Identification marks

- Tires **158**

Ignition **46**

Ignition

- Switched off **46**
- Switched on **46**

Ignition key position 1, refer to Radio ready state **45**

Ignition key position 2, refer to Ignition on **46**

Ignition key, refer to Remote control with integrated key **20**

Ignition lock **45**

Indication of a flat tire **76**

Indicator and warning lamps **15**

Indicator and warning lamps, Tire Pressure Monitor TPM **78**

Individual air distribution **90**

Inflation pressure monitoring, refer to Tire Pressure Monitor TPM **77**

Inflation pressure, refer to Tire inflation pressure **155**

Inflation pressure warning, tires **75**

Initializing

- Compass, refer to Calibrating **99**
- Flat Tire Monitor FTM **76**

Installation location

- Telephone **103**

Instrument cluster **14**

Instrument lighting **71**

Instrument panel, refer to Instrument cluster **14**

Instruments, refer to Cockpit **12**

Integrated key **20**

Interior equipment **96**  
 Interior lamps **72**  
 Interior lamps  
 – Remote control **23**  
 Interior rearview mirror **41**  
 Interior rearview mirror  
 – Automatic dimming **41**  
 – Compass **98**  
 Interior temperature, setting,  
 refer to Air conditioner **90**  
 Interior temperature, setting,  
 refer to Automatic climate  
 control **92**  
 Intermittent wipe **51**  
 Internet page **6**  
 Interval display, service re-  
 quirements **65**  
 iPod/iPhone **128**

## J

Jacking points **174**

## K

Keyless Go, refer to Comfort  
 Access **28**  
 Keyless opening and closing,  
 refer to Comfort Access **28**  
 Key Memory, refer to Personal  
 Profile **20**  
 Key, refer to Integrated key/re-  
 mote control **20**  
 Kick-down  
 – 7-gear automatic transmis-  
 sion **56**  
 – 8-gear automatic transmis-  
 sion **53**  
 Knee airbag **73**

## L

Lamps and bulbs, bulb re-  
 placement **170**  
 Lamps, replacing, refer to  
 Lamps and bulbs **170**

Lap-and-shoulder belt, refer to  
 Safety belts **38**  
 Lashing eyes, securing  
 cargo **112**  
 Launch Control, acceleration  
 assistant **58**  
 Leather, care **183**  
 LED, light-emitting di-  
 odes **171**  
 Length, refer to Dimen-  
 sions **203**  
 License plate lamp, bulb re-  
 placement **173**  
 Light **68**  
 Light-alloy wheels, care **184**  
 Light control **70**  
 Light-emitting diodes  
 LED **171**  
 Lighter  
 – Connecting electrical devi-  
 ces **100**  
 Lighting  
 – Instruments **71**  
 – Lamps and bulbs **170**  
 Light switch **68**  
 Load **111**  
 Loading **110**  
 Lockable lug bolts, refer to Lug  
 bolt lock **174**  
 Lock buttons, doors, refer to  
 Locking **27**  
 Locking  
 – From the inside **27**  
 – From the outside **23**  
 – Setting the confirmation sig-  
 nals **24**  
 – Without remote control, refer  
 to Comfort Access **28**  
 Locking the vehicle  
 – From the inside **26**  
 – From the outside **22**  
 Low beams **68**  
 Low beams, automatic, refer to  
 High-beam Assistant **71**  
 Lower back support, refer to  
 Lumbar support **37**  
 Lug bolt lock **174**  
 Lumbar support **37**

## M

M/S, automatic transmission  
 – 7-gear **57**  
 – 8-gear **54**  
 Maintenance **168**  
 Maintenance require-  
 ments **168**  
 Maintenance, service require-  
 ments **65**  
 Maintenance system,  
 BMW **168**  
 Malfunction  
 – Door lock **26**  
 – Fuel filler flap **152**  
 – Parking brake **50**  
 Malfunction warnings, refer to  
 Check Control **66**  
 Manual air distribution **90**  
 Manual mode  
 – 7-gear automatic transmis-  
 sion **57**  
 – 8-gear automatic transmis-  
 sion **54**  
 Manual operation  
 – Door lock **26**  
 – Driver's door **26**  
 – Fuel filler flap **152**  
 – Transmission lock **58**  
 Manual transmission **52**  
 Marking on approved  
 tires **161**  
 Marking, run-flat tires **161**  
 Master key, refer to Remote  
 control with integrated  
 key **20**  
 Maximum cooling **93**  
 Maximum speed, winter  
 tires **162**  
 Medical kit, refer to First aid  
 kit **177**  
 Memory, refer to Seat and mir-  
 ror memory **39**  
 Microfilter  
 – For air conditioner **91**  
 – With automatic climate con-  
 trol **95**

- Minimum tread depth, tires **160**
- Mirror
- Mirror memory, refer to Seat and mirror memory **39**
- Mirrors
- Automatic Curb Monitor **40**
  - Exterior mirrors **40**
  - Folding in, before driving into a car wash **41**
  - Heating **41**
  - Interior rearview mirror **41**
- Mobile communication devices in the vehicle **109**
- Mobile phone, installation location, refer to Center armrest **103**
- Modifications, technical, refer to Safety **6**
- Multifunction switch
- Refer to Turn signals/headlamp flasher **50**
- ## N
- Nets, refer to Storage compartments **104**
- New wheels and tires **161**
- Nozzles, refer to Air vents **89**
- Nozzles, refer to Ventilation **91, 94**
- Nylon rope, refer to Tow rope **180**
- ## O
- OBD Onboard Diagnostics **169**
- Odometer **60**
- Oil additives **166**
- Oil change interval, service requirements **65**
- Oil consumption **164**
- Oil level **164**
- Oil, refer to Engine oil **164**
- Oil types, alternative **166**
- Oil types, approved **166**
- Old batteries, disposal **175**
- Onboard computer, refer to Computer **62**
- Onboard Diagnostics OBD **169**
- Onboard vehicle tool kit **170**
- Opening and closing
- Comfort Access **28**
  - From the inside **26**
  - From the outside **22**
  - Using the door lock **25**
  - Using the remote control **22**
- Outside-air mode
- Automatic climate control **94**
- Outside air, refer to Recirculated air mode **90, 94**
- Overheating of engine, refer to Coolant temperature **61**
- Paint, vehicle **183**
- Park Distance Control PDC **87**
- Parked vehicle, condensation **110**
- Parking aid, refer to PDC **87**
- Parking lamps **68**
- Passenger airbags, deactivating **74**
- Passenger side mirror, tilting **40**
- PDC Park Distance Control **87**
- Personal Profile **20**
- Pinch protection
- Windows **32**
- Plastic, care **184**
- Pollen
- Refer to Microfilter/activated-charcoal filter with automatic climate control **95**
  - Refer to Microfilter for air conditioner **91**
- Power, refer to Engine data **202**
- Power windows, opening and closing **32**
- Power windows, refer to Windows **31**
- Pressure monitoring of tires, refer to Tire Pressure Monitor TPM **77**
- Pressure, tires **155**
- Pressure warning, tires **75**
- Pressure warning, tires
- Flat Tire Monitor **75**
  - Tire Pressure Monitor **77**
- Professional Radio **116**
- Protective function, refer to Pinch protection
- Windows **32**
- ## R
- Radiator fluid, refer to Coolant **166**
- Radio-operated key, refer to Remote control with integrated key **20**
- Radio ready state **45**
- Radio ready state
- Switched off **46**
  - Switched on **45**
- Radio setting, refer to Radio ready state **45**
- Rain sensor **51**
- Range **62**
- Reading lamps **72**
- Rear lamps
- Bulb replacement **172**
- Rear lamps, refer to Tail lamps **172**
- Rear lamps, refer to Tail lamps
- Bulb replacement **172, 173**
- Rearview mirror, refer to Mirrors **40**
- Rear window defroster **91, 94**
- Recirculated air mode **90, 94**
- Reclining seat, refer to Backrest **36**
- Recommended tire brands **161**

- Refueling [152](#)
- Remaining range, refer to Range [62](#)
- Remote control
- Battery replacement [30](#)
  - Comfort Access [28](#)
  - Garage door opener [96](#)
  - Malfunction [25, 29](#)
  - Removing from the ignition lock [45](#)
  - Trunk lid [23](#)
  - Universal [96](#)
- Replacement fuses, refer to Spare fuses [175](#)
- Replacement remote control [20](#)
- Replacing wheels/tires [161](#)
- Reporting safety defects [8](#)
- Reservoir for washer fluid [52](#)
- Restraining systems
- Refer to Safety belts [38](#)
- Restraint system
- For children [43](#)
- Retaining straps, securing cargo [112](#)
- Retractable hardtop
- Convenient opening and closing [23](#)
  - Opening and closing [34](#)
  - Remote control [23](#)
- Retreaded tires [161](#)
- Reverse gear
- 7-gear automatic transmission [56](#)
  - 8-gear automatic transmission [53](#)
  - Manual transmission [52](#)
- Roadside parking lamps [70](#)
- Roadworthiness test [65](#)
- Roof load capacity [204](#)
- Roof, refer to Retractable hardtop [33](#)
- Rope, refer to Tow-starting and towing [180](#)
- RPM, refer to Engine data [202](#)
- RSC Runflat System Component, refer to Run-flat tires [161](#)
- Rubber components, care [184](#)
- Run-flat tires [161](#)
- Run-flat tires
- Tire inflation pressure [155](#)
- Running lights, refer to Parking lamps/low beams [68](#)
- ## S
- Safety [6](#)
- Safety-belt height adjustment [39](#)
- Safety belts [38](#)
- Safety belts
- Damage [39](#)
  - Indicator/warning lamp [39](#)
  - Reminder [39](#)
- Safety belts, care [184](#)
- Safety systems
- Airbags [73](#)
  - Safety belts [38](#)
  - Safety tires [161](#)
- Saving fuel [112](#)
- Screw thread for tow fitting [179](#)
- Seat adjustment, electric [37](#)
- Seat adjustment, mechanical [36](#)
- Seat and mirror memory [39](#)
- Seat and mirror memory, retrieving automatically [24](#)
- Seat Belt Reminder, refer to Safety belt reminder [39](#)
- Seat belts
- Refer to Safety belts [38](#)
- Seat heating [38](#)
- Seats
- Adjusting [36](#)
  - Adjusting electrically [37](#)
  - Heating [38](#)
  - Memory, refer to Seat and mirror memory [39](#)
  - Storing the setting, refer to Seat and mirror memory [39](#)
- Sensors, care [185](#)
- Service and warranty [7](#)
- Service requirements, CBS Condition Based Service [168](#)
- Service requirements, display [65](#)
- Service, Roadside Assistance [177](#)
- Servotronic [84](#)
- Settings
- Clock, 12h/24h format [63](#)
- Settings and information [62](#)
- Settings, configuring, refer to Personal Profile [20](#)
- Shift paddles on steering wheel
- 7-gear automatic transmission [57](#)
  - 8-gear automatic transmission [54](#)
- Side airbags [73](#)
- Side windows, refer to Windows [31](#)
- Signal horn, refer to Horn [12](#)
- Sitting safely [36](#)
- Ski bag, refer to Through-loading opening with integrated transport bag [101](#)
- Slot for remote control [45](#)
- Snap-in adapter, mobile phone [143](#)
- Snap-in adapter, refer to Center armrest storage compartment [103](#)
- Socket, OBD Onboard Diagnostics [169](#)
- Socket, refer to Connecting electrical devices [100](#)
- SOS, refer to Emergency Request, initiating [176](#)
- Spare fuses [175](#)
- Special equipment, series equipment [6](#)
- Specified oil types [166](#)
- Speed, average [62](#)
- Speedometer [14](#)



- SPORT+ program, Dynamic Driving Control **83**
- Sport program
- 7-gear automatic transmission **57**
  - 8-gear automatic transmission **54**
- SPORT program, Dynamic Driving Control **83**
- Spray nozzles, refer to Cleaning the windshield and headlamps **51**
- Stability control systems **81**
- Start/Stop button
- Starting the engine **46**
  - Switching off the engine **46**
- Starting aid **177**
- Status of Owner's Manual **6**
- Steam jets **182**
- Steering wheel
- Adjusting **42**
  - Buttons on the steering wheel **12**
  - Lock **45**
- Stopping
- Engine **46**
- Storage compartments **104**
- Storage nets **100**
- Storage, tires **162**
- Storing the seat position, refer to Seat and mirror memory **39**
- Storing the vehicle **185**
- Summer tires, refer to Wheels and tires **155**
- Summer tires, tread **160**
- Suspension settings **82**
- Switches, refer to Cockpit **12**
- Switch for Dynamic Driving Control **82**
- Switching off
- Engine **46**
  - Vehicle **46**
- Symbols **6**
- Tailgate, opening from the inside **27**
- Tailgate, refer to Trunk lid **27**
- Tail lamps **172**
- Tail lamps
- Bulb replacement **172, 173**
- Tank display **61**
- Technical changes, refer to Safety **6**
- Technical data **202, 203**
- Telephone, installation location, refer to Center armrest **103**
- TeleService **146**
- Temperature, air conditioner **91**
- Temperature, automatic climate control **92**
- Temperature, coolant **61**
- Temperature display
- External temperature **60**
  - External temperature warning **60**
  - Setting the units **63**
- Temperature, engine oil **61**
- Theft alarm system, refer to Alarm system **30**
- Thigh support adjustment **37**
- Third brake lamp, refer to Center brake lamp **173**
- Through-loading opening with integrated transport bag **101**
- Tilting the passenger side mirror **40**
- Time
- Setting the time **64**
- Tire age **159**
- Tire damage **160**
- Tire identification marks **158**
- Tire pressure monitoring, refer to FTM **75**
- Tire Pressure Monitor TPM **77**
- Tire Pressure Monitor TPM
- Resetting the system **78**
  - System limitations **77**
  - Warning lamp **78**
- Tire Quality Grading **159**
- Tires, changing **161**
- Tires, flat tire **174**
- Tire size **158**
- Tires, pressure loss **78**
- Tires, pressure monitoring, refer to Tire Pressure Monitor TPM **77**
- Tires, run-flat tires **161**
- Tire tread **160**
- Tool kit, refer to Onboard vehicle tool kit **170**
- Tools, refer to Onboard vehicle tool kit **170**
- Torque, refer to Engine data **202**
- Tow bar **180**
- Tow fitting
- Screw thread **179**
- Tow fittings
- For tow-starting and towing **179**
- Towing **179**
- Towing methods **180**
- Tow rope **180**
- Tow-starting **179, 181**
- TPM, refer to Tire Pressure Monitor TPM **77**
- Traction control **82**
- TRACTION program, Dynamic Driving Control **83**
- Transmission
- 7-gear automatic transmission with dual clutch **55**
  - 8-gear automatic transmission **53**
  - Manual transmission **52**
  - Unlocking transmission lock manually, for 7-gear automatic transmission **58**
- Transmission lock, unlocking manually **58**
- Transmission lock, unlocking manually, with 7-gear automatic transmission **58**

## T

Tachometer **61**



- Transmission positions
  - 7-gear automatic transmission 55
  - 8-gear automatic transmission 53
- Transporting children safely 43
- Tread depth, tires 160
- Tread, tires 160
- Trip-distance counter, refer to Trip odometer 60
- Triple turn signal activation 50
- Trip odometer 60
- Trunk
  - Comfort Access 29
- Trunk lid
  - Comfort Access 29
  - Emergency unlocking 28
  - Opening from the inside 27
  - Opening from the outside 27
  - Remote control 23
- Turning circle, refer to Dimensions 203
- Turn signal
  - Indicator/warning lamp 14
- Turn signals 50
- Turn signals
  - Bulb replacement, front 172
  - Triple turn signal activation 50

## U

- Uniform Tire Quality Grading/UTQG 159
- Unintentional alarms 31
- Units
  - Average fuel consumption 63
  - Temperature 63
- Universal Garage Door Opener 96
- Universal remote control 96

- Unlocking
  - From the inside 27
  - From the outside 22
  - Hood 164
  - Setting the unlocking characteristics 22
  - Trunk lid 29
  - Without remote control, refer to Comfort Access 28
- Updates made after the editorial deadline 6
- Upholstery care 183
- USB audio interface 128

## V

- Vacuum cleaner, connecting, refer to Connecting electrical devices 100
- Vehicle
  - Battery replacement 174
  - Breaking in 108
  - Cargo 204
  - Dimensions, refer to Dimensions 203
  - Identification number, refer to Engine compartment 163
  - Weight 204
- Vehicle care 183
- Vehicle care, refer to Care 182
- Vehicle equipment 6
- Vehicle jack 174
- Vehicle paint 183
- Vehicle storage 185
- Vehicle, switching off 46
- Vehicle wash 182
- Ventilation
  - Draft-free 91, 95
  - Refer to Climate control 89
- Vents, refer to Air vents 89
- Voice activation, mobile phone 141

## W

- Warning and indicator lamps 15

- Warning messages, refer to Check Control 66
- Warning triangle 177
- Washer/wiper system 51
- Washing, vehicle 182
- Water on roads 109
- Wear indicator in tire 160
- Welcome lamps 68
- Wheelbase, refer to Dimensions 203
- Wheel change 173
- Wheels and tires 155
- Wheels, changing 161
- Wheels, Flat Tire Monitor FTM 75
- Width, refer to Dimensions 203
- Wind deflector 34
- Window, convenient opening and closing 23
- Windows, defrosting and defogging
  - Automatic climate control 94
- Windows, defrosting and removing condensation
  - Air conditioner 91
- Windows, pinch protection 32
- Windshield
  - Cleaning 51
  - Defrosting and defogging, air conditioner 91
  - Defrosting and defogging, automatic climate control 94
- Windshield, defrosting, refer to Defrosting windows 91
- Windshield wash 51
- Windshield wash
  - Filling capacity, reservoir 206
  - Nozzles 52
  - Washer fluid 52
- Windshield washer fluid 52
- Windshield wiper blades, changing 170
- Windshield wiper, refer to Washer/wiper system 51

- Winter storage, care [185](#)
- Winter tires, suitable tires [162](#)
- Winter tires, tread [160](#)
- Wiper blades, changing [170](#)
- Wiper fluid [52](#)
- Wood, care [184](#)
- Working in the engine compartment [164](#)
- Wrench/screwdriver, refer to Onboard vehicle tool kit [170](#)

## X

- Xenon headlamps
  - Bulb replacement [171](#)

## Y

- Your individual vehicle
  - Settings, refer to Personal Profile [20](#)

امداد خودرو فارما

تلفن شبانه روزی: ۰۲۱-۸۸۸۶۲۰۸۵

FarmaSOS.com

# امداد خودرو فارما

تلفن شبانه روزی: ۰۲۱-۸۸۸۶۲۰۸۵

**FarmaSOS.com**

More about BMW



The Ultimate Driving  
Machine

bmwusa.com

# امداد خودرو فارما

تلفن شبانه روزی: ۰۲۱-۸۸۸۶۲۰۸۵

[FarmaSOS.com](http://FarmaSOS.com)

01 40 2 609 184 ue

