

Contents

A-Z

THE BMW i8.
OWNER'S MANUAL.

امداد خودرو فارما

تلفن شبانه روزی: ۰۲۱-۸۸۸۶۲۰۸۵

FarmaSOS.com

BMW i. 



BMW i SUSTAINABILITY.

THE SPORTS CAR.
REINVENTED. •

امداد خودرو فارما

تلفن شبانه روزی: ۰۲۱-۸۸۸۶۲۰۸۵

FarmaSOS.com

THE SUSTAINABLE LIFE CYCLE OF BMW i.



01. DEVELOPMENT

- Lightweight carbon fiber construction to minimize weight.
- Efficient drive technology and perfect aerodynamics – resulting in less wind resistance.

امداد خودرو فارما

شماره تماس: ۰۸۵+۸۸۸۶۲-۲۱

FarmaSOS.com

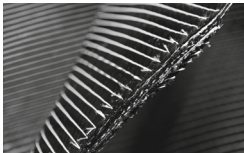

04. RECYCLING

- Re-use of battery modules, for example as temporary storage units for solar energy.
- Recycling carbon fibers by returning them to the production process.



03. UTILIZATION

- Optimal efficiency thanks to the innovative BMW eDrive technology.
- A combination of an electric drive system for emission-free driving and a BMW TwinPower Turbo engine for maximum performance.

امداد خودرو فارما

تلفن شبانه روزی: ۰۲۱-۸۸۸۶۳۰۸۵

FarmaSOS.com



02. PRODUCTION

- Use of renewable electricity for the production of BMW i vehicles.
- Reduction of energy and water consumption in production.

01. DEVELOPMENT

FOR OVER THREE QUARTERS OF A CENTURY, THE BASIC IDEA BEHIND THE CAR WAS LEFT UNTOUCHED.

Until now. BMW i has launched a groundbreaking sports car with a wide range of technological innovations – the BMW i8. The innovative BMW eDrive technology effectively combines an electric motor with a BMW TwinPower Turbo engine (hybrid electric vehicle). The result is a breathtaking plug-in hybrid sports car with the fuel consumption and emissions of a compact vehicle.

The weight of the BMW i8 is a result of the Life module – the passenger cell made of light and extremely robust carbon fiber. It substantially reduces the weight of the vehicle and has a significant impact on the design of the BMW i8. The principle of intelligent lightweight design has also been applied to all other components of the BMW i8. Moreover, streamflow aerodynamics reduce drag and energy consumption.

With its dynamic proportions and sporty, progressive design, the BMW i8 embodies lightness – as well as efficiency and sheer driving pleasure. The development process itself is the first of many innovations. In order to ensure that the BMW i8 is a truly sustainable product, measurable targets were defined at the design phase and throughout the entire life cycle of the vehicle, from the extraction of raw materials, production and use to recycling and the end of product life. The deliberate use of recycled and environmentally friendly materials in production guarantees holistic sustainability throughout the entire value chain.

For more information, visit www.bmw-i.com.

The Life module is made of ultra-light carbon fiber.



30%

lighter than aluminum.

امداد نوروز پارما
50%

lighter than steel.

تلفن شبانه روزی: ۰۲۱-۸۸۸۶۲۰۸۵

FarmaSOS.com

The interior features premium sustainable materials. Approximately 20% of the thermoplastics in the interior are produced using recycled or renewable materials.

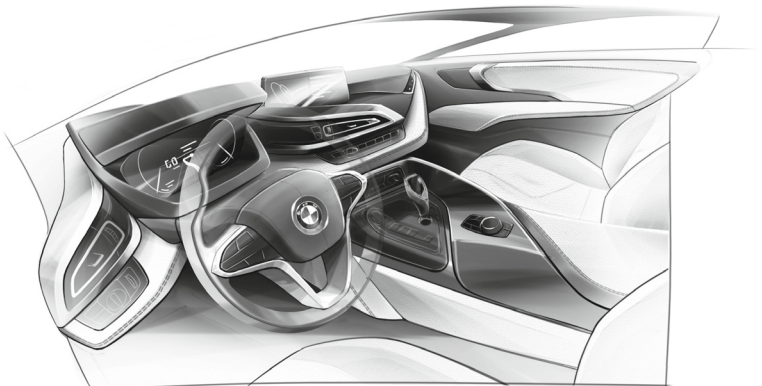

02. PRODUCTION

THE BMW i8: FORGED BY THE POWER OF WIND AND WATER.

Sustainability plays a crucial role for the BMW i8, and the same is true for the production process. All of the electricity required for the manufacturing process in the BMW i Plant in Leipzig is produced from renewable sources. BMW has been leading the way in sustainable production for a long time now, but BMW i has gone even further and significantly improved its facilities. The BMW i plant in Leipzig produces its own renewable electricity from wind power – directly on the factory premises – and operates on 100% clean electric power with zero emissions. It also features significantly reduced resource consumption.

Similarly, the carbon fiber production facility located in Moses Lake (USA) is powered completely by renewable electricity from the large number of hydroelectric plants in the area.

For BMW i sustainable production has not only an environmental dimension but a social one as well, creating future-proof job profiles and training BMW i's suppliers to comply with advanced sustainability standards.

-20%



water consumption

100%



use of energy from
renewable sources
at the Leipzig plant.



Consumption of energy and
resources for each BMW i8
produced.*

* Compared to the average
of all BMW models, which
sets the standard for the
automotive industry.

03. UTILIZATION

A SUSTAINABLE COMBINATION: INTELLIGENT ENERGY MANAGEMENT FOR INSPIRING PERFORMANCE AND OPTIMUM EFFICIENCY.

BMW has been pursuing its EfficientDynamics strategy for more than a decade. However, no other vehicle combines driving pleasure and sustainability like the BMW i8. Equipped with innovative BMW eDrive technology that intelligently combines an internal combustion engine with an electric drive system, the BMW i8 offers maximum performance and sustainable efficiency.

In an urban environment, the BMW i8 offers a range of up to 37 kilometers when traveling on electric power only. For longer distances, support is provided by the BMW TwinPower Turbo engine – with an especially intense boost feature in SPORT mode or maximum efficiency in ECO PRO mode. A predictive power management system developed specifically for the BMW i8 ensures optimal settings for the two drive units at all times.

Additionally, every driver can also help to optimize sustainability when recharging the car: if renewable energy is used to charge the battery, CO₂ emissions are reduced even further. Therefore, BMW i recommends green electricity suppliers to make an even greater contribution to environmental protection.

2.1 l/100 km

fuel consumption (EU)



49 g/km

CO₂ emissions

04. RECYCLING

FOR THE BMW i8 WE NOT ONLY PIONEER NEW MATERIALS, WE ALSO TAKE CARE OF THEIR RECYCLING.

Recycling is a given at BMW i. Excess material from carbon fiber production, carbon components and body parts, for instance, are valuable materials. That's why they are either reused as secondary raw materials for the in-house BMW i production cycle or recycled for other automotive and non-automotive applications. At the start of production for a BMW i8, more than 5% of the carbon fiber required is already recycled material. Together with its partners, BMW i is pioneering closed loops for up to 100% of carbon fiber from production residues or end-of-life vehicles.

The BMW Group is always looking for innovative solutions, and this is also the case when it comes to recycling high-voltage batteries. For example, the batteries could serve as temporary storage cells for renewable energy. A particularly effective application is to use the batteries to store solar and wind energy so that generated power can be used when it is actually needed.

100%



of old batteries can be used again as temporary storage units in solar power plants and wind farms, for example.

امداد خودرو فارما

تلفن شبانه روزی: ۰۲۱-۸۸۸۶۲۰۸۵

FarmaSOS.com

For more information about BMW i
and its sustainability philosophy, visit:
www.bmw-i.com/sustainability

امداد خودرو فارما

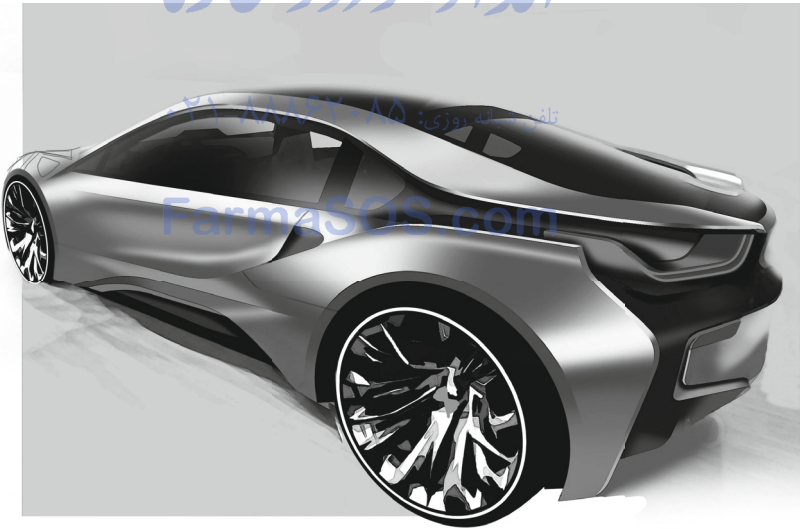

i8 Owner's Manual for Vehicle

Thank you for choosing a BMW i.

The more familiar you are with your vehicle, the better control you will have on the road. We therefore strongly suggest:

Read this Owner's Handbook before starting off in your new BMW i. Also use the Integrated Owner's Manual in your vehicle. It contains important information on vehicle operation that will help you make full use of the technical features available in your BMW i. The manual also contains information designed to enhance operating reliability and road safety, and to contribute to maintaining the value of your BMW i.

Any updates made after the editorial deadline can be found in the appendix of the Owner's Handbook for Vehicle.

We wish you a safe and enjoyable ride.

BMW AG

امداد خودرو فارما

تلفن شبانه روزی: ۰۲۱-۸۸۸۶۲۰۸۵

FarmaSOS.com

The Owner's Manual is available in many countries as an app.

Additional information on the Internet:

www.bmw.com/bmw_i_drivers_guide

امداد خودرو فارما

تلفن شبانه روزی: ۰۲۱-۸۸۸۶۲۰۸۵

FarmaSOS.com

© 2015 Bayerische Motoren Werke
Aktiengesellschaft

Munich, Germany

Reprinting, including excerpts, only with the written
consent of BMW AG, Munich.

US English II/15, 03 15 490

Printed on environmentally friendly paper, bleached
without chlorine, suitable for recycling.

ADDENDUM TO OWNER'S MANUAL

We wanted to provide you with some updates and clarifications with respect to the printed BMW Owner's Manual. These updates and clarifications will supersede the materials contained in that document.

1. Where the terms “service center,” “the service center,” “your service center,” “service specialist,” or “service” are used in the Owner's Manual, we wanted to clarify that the terms refer to a BMW dealer's service center or another service center or repair shop that employs trained personnel that can perform maintenance and repair work on your vehicle in accordance with BMW specifications.
2. Where the text of the Owner's Manual contains an affirmative instruction to contact a “service center” or “your service center,” we wanted to clarify that BMW recommends that, if you are faced with one of the situations addressed by that text, you contact or seek the assistance of a BMW dealer's service center or another service center or repair shop that employs trained personnel that can perform maintenance and repair work on your vehicle in accordance with BMW specifications.

While BMW of North America LLC, at no cost to you, will pay for repairs required by the limited warranties provided with respect to your vehicle and for maintenance under the Maintenance Program during the applicable warranty and maintenance coverage periods, you are free to elect, both during those periods and thereafter, to have maintenance and repair work provided by other service centers or repair shops.

3. Where the Owner's Manual makes reference to parts and accessories having been approved by BMW, those references are intended to reflect that those parts and accessories are recommended by BMW of North America LLC. You may elect to use other parts and accessories, but, if you do,

we recommend that you make sure that any such parts and/or accessories are appropriate for use on your vehicle.

4. At page 7, under the warranty section's discussion of homologation, where it states that you “cannot lodge warranty claims for your vehicle there,” the text should read that you “may not be able to lodge warranty claims for your vehicle there.”
5. At page 7, under the heading “Body work and working on the high-voltage system,” the text of that section should be disregarded and the following text should be read in lieu thereof: “BMW recommends to have modifications and work on the vehicle only be carried out by an authorized BMW i service center or one that operates according to BMW i specifications with personnel trained accordingly. If work is not carried out properly, there is the risk of fire and fatal injury from electrocution due to the high-voltage system's high voltage.”
6. At page 8, under the “Parts and Accessories” section, in the sixth sentence, the word “cannot” should read “does not.”
7. At page 53, in the “Check and replace safety belts” section, the text beginning, “This should only be done by your service center ...” should be disregarded and the following text should be read in lieu thereof: “BMW recommends having this work performed by a service center as it is important that this safety feature functions properly.”
8. At page 91, under the heading: “Special windshield,” the paragraph beginning, “Therefore, have the special windshield ...” should be disregarded and the following text should be read in lieu thereof: “BMW recommends that you have the special windshield replaced by the service center.”
9. At page 141 under the heading: “Objects within the range of movement of the pedals” and at page 190 under the heading:

“Carpets and floor mats,” the paragraph that begins: “Only use floor mats ...” should be disregarded and the following language should be read in lieu thereof: “The manufacturer of your vehicle recommends that you use floor mats that have been identified by it as appropriate for use in your vehicle and that can be properly fixed in place.”

10. At page 145, under the heading: “Have maintenance carried out,” the sentence beginning, “The maintenance should be carried out ...” should be disregarded and the following text should be read in lieu thereof: “BMW recommends that you have the maintenance carried out by your service center.”
11. At page 151, under the heading “Make sure that the charging device is in flawless operating condition,” the word “flawless” should read “proper.”
12. At page 163, under the heading “Tire inflation specifications,” the sentence beginning, “Tire inflation pressure specifications apply to approved tire sizes ...” should be disregarded.
13. At page 167, under the heading: “Mounting,” the paragraph beginning, “Have mounting and balancing ...” should be disregarded and the following text should be read in lieu thereof: “BMW recommends that you have mounting and balancing performed by your service center or a tire mounting specialist.”
14. At page 167, under the heading: “Approved wheels and tires,” the term “Approved” should be disregarded and in lieu thereof, the term “Recommended” should be read in its place. In addition, the text of that section should be disregarded and the following text should be read in lieu thereof:
The manufacturer of your vehicle strongly suggests that you use wheels and tires that have been recommended by the vehicle manufacturer for your vehicle type; otherwise, for example, despite having the same

official size ratings, variations can lead to body contact and with it, the risk of severe accidents.

The manufacturer of your vehicle does not evaluate non-recommended wheels and tires to determine if they are suitable for use on your vehicle.

15. At page 171, under the heading: “Snow Chains,” the text should be disregarded and the following text should be read in lieu thereof:

Only certain types of fine-link snow chains have been tested by the manufacturer of your vehicle and are determined by the manufacturer of your vehicle to be road safe and are recommended by the manufacturer of your vehicle.

Information about recommended snow chains is available from a service center.

16. At page 174, under the heading “Engine compartment access,” the sentence beginning, “If you are unfamiliar” should be disregarded.
17. At page 176, under the heading: “Engine Oil Change,” the text should be disregarded and in lieu thereof should be read as follows:
BMW recommends that you have the oil changed at your BMW dealer's service center or at another service center that has trained personnel that can perform the work in accordance with BMW specifications.
18. At page 179, under the heading: “Service and Warranty Information Booklet for US models and Warranty and Service Guide Booklet for Canadian models,” the second paragraph should be disregarded and the following text read in lieu thereof:
The manufacturer of your vehicle recommends that you have maintenance and repair performed by your BMW dealer's service center or another service center or repair shop that employs trained personnel that can perform maintenance and repair work on your vehicle in accordance with

BMW specifications. The manufacturer of your vehicle recommends that you maintain records of all maintenance and repair work performed on your vehicle.

19. At page 181 where it reads: “Have any work on the lighting system ... ,” the following words should be read as preceding that passage: “It is strongly suggested that you”
20. At page 181, under the “Battery replacement” section, the text should be disregarded and in lieu thereof the following text should be read:

Use of recommended vehicle batteries

The manufacturer of your vehicle recommends that you use vehicle batteries that it has tested and recommends for use in your vehicle; otherwise the vehicle could be damaged and systems or functions may not be fully available.

After a battery replacement, the manufacturer of your vehicle recommends that you have the battery registered on your vehicle by a service center to ensure that all comfort functions are fully available, and that any “check control” messages of these comfort functions are no longer displayed.

امداد خودرو فارما

تلفن شبانه روزی: ۰۲۱-۸۸۸۶۲۰۸۵

FarmaSOS.com

Contents

The fastest way to find information on a particular topic or item is by using the index, refer to page 198.

6 Notes

At a glance

14 Cockpit

18 iDrive

26 Voice activation system

29 Integrated Owner's Manual in the vehicle

31 BMW eDRIVE

34 Safety of the high-voltage system

Controls

38 Opening and closing

51 Adjusting

57 Transporting children safely

61 Driving

75 Displays

92 Lights

96 Safety

109 Driving stability control systems

113 Driving comfort

124 Climate control

129 Interior equipment

134 Storage compartments

Driving tips

138 Things to remember when driving

142 Loading

144 Increase range

Mobility

150 Charging vehicle

158 Refueling

161 Fuel

163 Wheels and tires

173 Engine oil

177 Coolant

178 Maintenance

180 Replacing components

183 Breakdown assistance

187 Care

Reference

194 Technical data

196 Appendix

198 Everything from A to Z

تلفن شبانه روزی: ۰۲۱-۸۸۸۶۲۰۸۵

FarmaSOS.com

Notes

Using this Owner's Manual

Orientation

The fastest way to find information on a particular topic is by using the index.

An initial overview of the vehicle is provided in the first chapter.

Updates made after the editorial deadline

Any updates made after the editorial deadline can be found in the appendix of the printed Owner's Handbook for Vehicle.

User's manual for Navigation, Entertainment, Communication

The topics Navigation, Entertainment, Communication and the short commands of the voice activation system can be retrieved on the Control Display via the Integrated Owner's Handbook.

Additional sources of information

The service center will be happy to answer any other questions you may have.

Information on BMW, e.g., on technology, is available on the Internet: www.bmwusa.com.

BMW i Driver's Guide App

The Owner's Manual is available in many countries as an app. Additional information on the Internet:

www.bmw.com/bmw_i_drivers_guide

Symbols

 Indicates precautions that must be followed precisely in order to avoid the possibility of personal injury and serious damage to the vehicle.

◀ Marks the end of a specific item of information.

 Refers to measures that can be taken to help protect the environment.

"..." Identifies display texts in vehicle used to select individual functions.

>...< Verbal instructions to use with the voice activation system.

»...« Identifies the answers generated by the voice activation system.

Symbols on vehicle components

 Indicates that you should consult the relevant section of this Owner's Manual for information on a particular part or assembly.

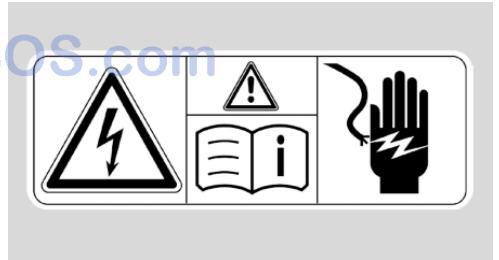

Indicates, on certain parts or assemblies, that incorrect use of high-voltage equipment or of orange-colored high-voltage components results in the risk of life-threatening injury from electric shock.

Vehicle features and options

This Owner's Manual describes all models and all standard, country-specific and optional

equipment that is offered in the model series. Therefore, in this Owner's Manual, we also describe and illustrate features that are not available in your vehicle, e.g., because of the selected optional features or the country-specific version.

This also applies to safety-related functions and systems.

The respectively applicable country provisions must be observed when using the respective features and systems.

On right-hand drive vehicles, some controls are arranged differently from what is shown in the illustrations.

Status of the Owner's Manual

Basic information

The manufacturer of your vehicle pursues a policy of constant development that is conceived to ensure that our vehicles continue to embody the highest quality and safety standards. In rare cases, therefore, the features described in this Owner's Manual may differ from those in your vehicle.

Updates made after the editorial deadline

Any updates made after the editorial deadline can be found in the appendix of the printed Owner's Handbook for Vehicle.

For your own safety

Warranty

Your vehicle is technically configured for the operating conditions and registration requirements applying in the country of first delivery - homologation. If your vehicle is to be operated in a different country it might be necessary to adapt your vehicle to potentially differing oper-

ating conditions and permit requirements. If your vehicle does not comply with the homologation requirements in a certain country you cannot lodge warranty claims for your vehicle there. Further information can be obtained from your Service Centre.

Working on the vehicle, maintenance and repairs

Advanced technology, especially the use of high-performance high-voltage electronics and modern materials such as carbon, requires special knowledge when making modifications to and working on the vehicle, as well as customized maintenance and repair work.

BMW recommends to have modifications and work on the vehicle, especially maintenance and repairs to the high-voltage system and carbon body as well as the retrofitting of accessories only be carried out by an authorized BMW i service center or one that operates according to BMW i specifications with personnel trained accordingly.



Body work and working on the high-voltage system

Do not perform any modifications or work on the vehicle, especially maintenance and repair work on the high-voltage system and the carbon body and avoid retrofitting accessories.

If work is not carried out properly, there is the risk of fire and fatal injury from electrocution due to the high-voltage system's high voltage.

BMW recommends to have modifications and work on the vehicle only be carried out by an authorized BMW i service center or one that operates according to BMW i specifications with personnel trained accordingly. ◀

Parts and accessories

BMW recommends using parts and accessories approved by BMW for this purpose.

Your BMW center is the right contact for genuine BMW parts and accessories, other prod-

ucts approved by BMW and related qualified advice.

BMW has tested these products for safety and suitability in relation to BMW vehicles.

BMW can assume responsibility for them. However, we cannot assume any responsibility whatsoever for parts and accessories that have not been specifically approved by BMW.

BMW cannot evaluate whether each individual product from another manufacturer can be used with BMW vehicles without presenting a safety hazard. This guarantee does not apply when country-specific government approval has been granted. Testing of this kind may fail to embrace the entire range of potential operating conditions to which components might be exposed on BMW vehicles. Such products could conceivably fail to comply with BMW's own stringent quality standards.

California Proposition 65 Warning

California laws require us to state the following warning:

Engine exhaust and a wide variety of automobile components and parts, including components found in the interior furnishings in a vehicle, contain or emit chemicals known to the State of California to cause cancer and birth defects and reproductive harm. In addition, certain fluids contained in vehicles and certain products of component wear contain or emit chemicals known to the State of California to cause cancer and birth defects or other reproductive harm. Battery posts, terminals and related accessories contain lead and lead compounds. Wash your hands after handling. Used engine oil contains chemicals that have caused cancer in laboratory animals. Always protect your skin by washing thoroughly with soap and water.

Service and warranty

We recommend that you read this publication thoroughly. Your vehicle is covered by the following warranties:

- ▷ New Vehicle Limited Warranty.
- ▷ Rust Perforation Limited Warranty.
- ▷ Federal Emissions System Defect Warranty.
- ▷ Federal Emissions Performance Warranty.
- ▷ California Emission Control System Limited Warranty.

Detailed information about these warranties is listed in the Service and Warranty Information Booklet for US models or in the Warranty and Service Guide Booklet for Canadian models.

Your vehicle has been specifically adapted and designed to meet the particular operating conditions and homologation requirements in your country and continental region in order to deliver the full driving pleasure while the vehicle is operated under those conditions. If you wish to operate your vehicle in another country or region, you may be required to adapt your vehicle to meet different prevailing operating conditions and homologation requirements. You should also be aware of any applicable warranty limitations or exclusions for such country or region. In such case, please contact Customer Relations for further information.

Maintenance

Maintain the vehicle regularly to sustain the road safety, operational reliability and the New Vehicle Limited Warranty.

Specifications for required maintenance measures:

- ▷ BMW Maintenance system
- ▷ Service and Warranty Information Booklet for US models
- ▷ Warranty and Service Guide Booklet for Canadian models

If the vehicle is not maintained according to these specifications, this could result in serious damage to the vehicle. Such damage is not covered by the BMW New Vehicle Limited Warranty.

Data memory

Many electronic components on your vehicle are equipped with data memories that temporarily or permanently store technical information about the condition of the vehicle, events and faults. This technical information generally records the state of a component, a module, a system or the environment:

- ▶ Operating mode of system components, fill levels for instance.
- ▶ Status messages for the vehicle and from its individual components, e.g., wheel rotation speed/vehicle speed, deceleration, transverse acceleration.
- ▶ Malfunctions and faults in important system components, e.g., lights and brakes.
- ▶ Responses by the vehicle to special situations such as airbag deployment or engaging the stability control system.
- ▶ Ambient conditions, such as temperature.

This data is purely technical in nature and is used to detect and correct faults and to optimize vehicle functions. Motion profiles over routes traveled cannot be created from this data. When service offerings are used, e.g., repair services, service processes, warranty claims, quality assurance, this technical information can be read out from the event and fault memories by the service personnel, including the manufacturer, using special diagnostic tools. You can obtain further information there if you need it. After an error is corrected, the information in the fault memory is deleted or overwritten on a continuous basis.

With the vehicle in use there are situations where you can associate these technical data with individuals if combined with other information, e.g., an accident report, damage to the vehicle, eye witness accounts — possibly with the assistance of an expert.

Additional functions that are contractually agreed with the customer - such as vehicle

emergency locating - you can transmit certain vehicle data from the vehicle.

Event Data Recorder EDR

This vehicle is equipped with an event data recorder EDR. The main purpose of an EDR is to record, in certain crash or near crash-like situations, such as an air bag deployment or hitting a road obstacle, data that will assist in understanding how a vehicle's systems performed. The EDR is designed to record data related to vehicle dynamics and safety systems for a short period of time, typically 30 seconds or less.

The EDR in this vehicle is designed to record such data as:

- ▶ How various systems in your vehicle were operating.
- ▶ Whether or not the driver and passenger safety belts were fastened.
- ▶ How far, if at all, the driver was depressing the accelerator and/or brake pedal.
- ▶ How fast the vehicle was traveling.

These data can help provide a better understanding of the circumstances in which crashes and injuries occur.

EDR data are recorded by your vehicle only if a nontrivial crash situation occurs; no data are recorded by the EDR under normal driving conditions and no personal data, e.g., name, gender, age, and crash location, are recorded.

However, other parties, such as law enforcement, could combine the EDR data with the type of personally identifying data routinely acquired during a crash investigation.

To read data recorded by an EDR, special equipment is required, and access to the vehicle or the EDR is needed. In addition to the vehicle manufacturer, other parties, such as law enforcement, that have the special equipment, can read the information if they have access to the vehicle or the EDR.

Vehicle identification number

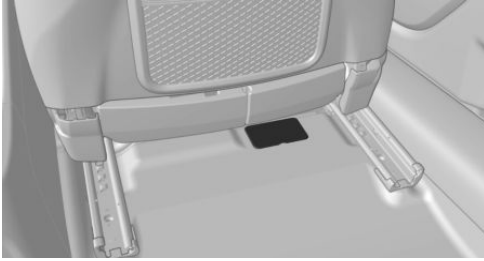

The vehicle identification number can be found under a cover under the front passenger seat.

The vehicle identification number can also be found behind the windshield.

formation about motor vehicle safety from <http://www.safercar.gov>.

For Canadian customers

Canadian customers who wish to report a safety-related defect to Transport Canada, Defect Investigations and Recalls, may call the toll-free hotline 1-800-333-0510. You can also obtain other information about motor vehicle safety from <http://www.tc.gc.ca/roadsafety>.

Reporting safety defects

For US customers

The following only applies to vehicles owned and operated in the US.

If you believe that your vehicle has a defect which could cause a crash or could cause injury or death, you should immediately inform the National Highway Traffic Safety Administration NHTSA, in addition to notifying BMW of North America, LLC, P.O. Box 1227, Westwood, New Jersey 07675-1227, Telephone 1-800-831-1117.

If NHTSA receives similar complaints, it may open an investigation, and if it finds that a safety defect exists in a group of vehicles, it may order a recall and remedy campaign.

However, NHTSA cannot become involved in individual problems between you, your dealer, or BMW of North America, LLC.

To contact NHTSA, you may call the Vehicle Safety Hotline toll-free at 1-888-327-4236 (TTY: 1-800-424-9153); go to <http://www.safercar.gov>; or write to: Administrator, NHTSA, 400 Seventh Street, SW., Washington, DC 20590. You can also obtain other in-

امداد خودرو فاروا

تلفن شبانه روزی: ۰۲۱-۸۸۸۶۲۰۸۵

www.asos.com

امداد خودرو فارما

تلفن شبانه روزی: ۰۲۱-۸۸۸۶۲۰۸۵

FarmaSOS.com



امداد خودرو فارما

شماره تماس: ۰۲۱-۸۸۸۶۲۰۸۵

FarmaSOS.com

At a glance

These overviews of buttons, switches and displays are intended to familiarize you with your vehicle. You will also become quickly acquainted with the available control concepts and options.

امداد خودرو فارما

تلفن شبانه روزی: ۰۲۱-۸۸۸۶۲۰۸۵

FarmaSOS.com

Cockpit

Vehicle features and options

This chapter describes all standard, country-specific and optional features offered with the series. It also describes features that are not necessarily available in your car, e. g., due to

the selected options or country versions. This also applies to safety-related functions and systems. The respectively applicable country provisions must be observed when using the respective features and systems.

All around the steering wheel

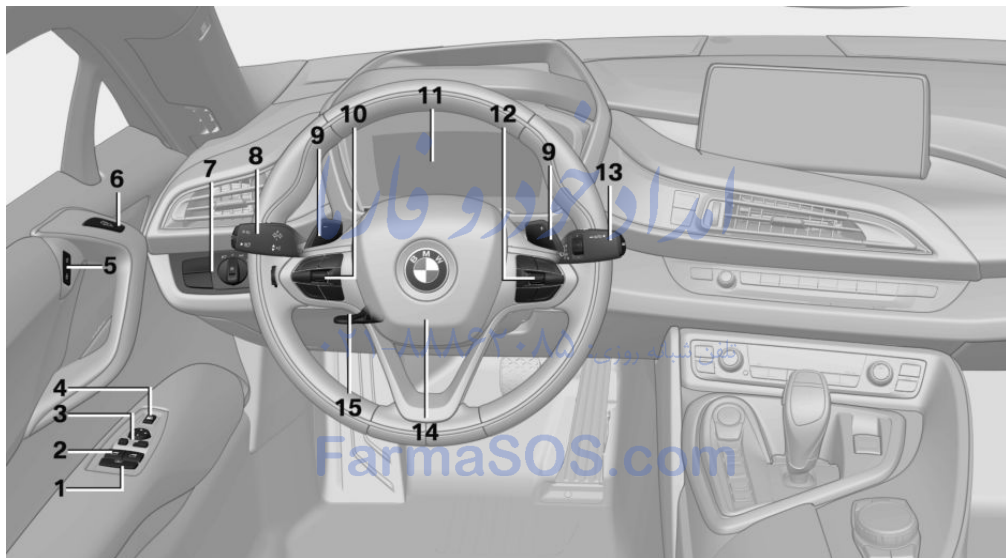

1 Open the tailgate 44

2 Power windows 49

3 Exterior mirror operation 54

4 Open fuel filler flap,
Tank vent 158

5 Lock, unlock vehicle 44

6 Opening the door 44

7 Lights



Parking lights 92



Low beams 92



Automatic headlight control 93

Daytime running lights 93

High-beam Assistant 94



Instrument lighting 95

8 Left steering column stalk



Turn signal 67



High beams, headlight flasher 67



High-beam Assistant 94



Roadside parking lights 93



On-board computer 87

9 Shift paddles 73

10 Steering wheel buttons, left



Store speed 113



Resume speed 114



Cruise control on/off, interrupting 113

Cruise control rocker switch 114

11 Instrument cluster 75

12 Steering wheel buttons, right



Entertainment source



Volume



Voice activation 26



Telephone

Thumbwheel for selection lists 86

13 Right steering column stalk



Wiper 68



Rain sensor 69



Clean the windshields and headlights 69





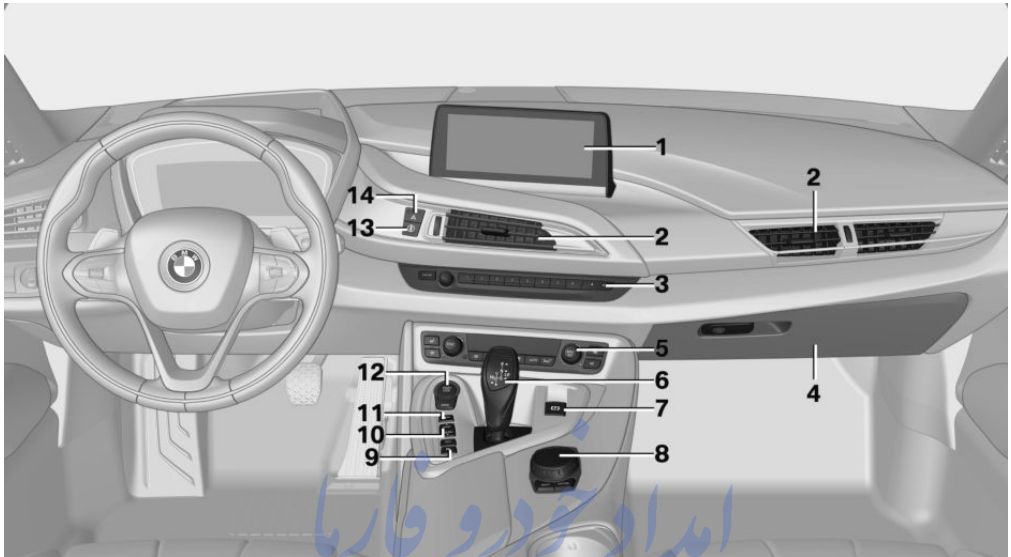

14 Horn, total area

15 Adjust steering wheel 56

FarmaSOS.com





All around the center console



- 1 Control Display 18
- 2 Ventilation 127
- 3 Radio/Multimedia, refer to Integrated Owner's Handbook
- 4 Glove compartment 134
- 5 Climate control 124
- 6 Steptronic Sport transmission 70
- 7 Parking brake 66
- 8 Controller with buttons 18
- 9  PDC Park Distance Control 115
Rearview camera 117
Surround View 117
- 10  Driving Dynamics Control 111
- 11 DSC Dynamic Stability Control 109
- 12  Start/Stop button 61
-  Max eDRIVE 64
- 13  Intelligent Safety 102
- 14  Hazard warning system 183

All around the roofliner



- | | | | | | |
|---|---|--|---|---|---------------------------|
| 1 |  | Intelligent Emergency Re-
quest 183 | 3 |  | Reading lights 95 |
| 2 |  | Indicator lamp, front-seat pas-
senger airbag 98 | 4 |  | Interior lights 95 |

FarmaSOS.com

iDrive

Vehicle features and options

This chapter describes all standard, country-specific and optional features offered with the series. It also describes features that are not necessarily available in your car, e. g., due to the selected options or country versions. This also applies to safety-related functions and systems. The respectively applicable country provisions must be observed when using the respective features and systems.

The concept

The iDrive combines the functions of many switches. Thus, these functions can be operated from a central location.



Using the iDrive during a trip

To avoid becoming distracted and posing an unnecessary hazard to your vehicle's occupants and to other traffic, never attempt to use the controls or enter information unless traffic and road conditions allow it. ◀

Control elements at a glance

Control elements

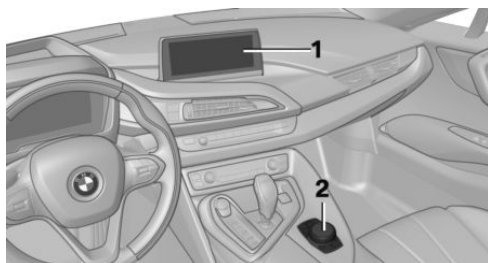

- 1 Control Display
- 2 Controller with buttons and, depending on the equipment version, with touchpad

Control Display

Hints

- ▶ To clean the Control Display, follow the care instructions.
- ▶ Do not place objects close to the Control Display; otherwise, the Control Display can be damaged.
- ▶ In the case of very high temperatures on the Control Display, e.g. due to intense solar radiation, the brightness may be reduced down to complete deactivation. Once the temperature is reduced, e.g. through shadow or climate control system, the normal functions are re-established.

Switching on

1. Turn on operations.
2. Press the controller.

Switch off

1.  Press button.
2. "Turn off control display"

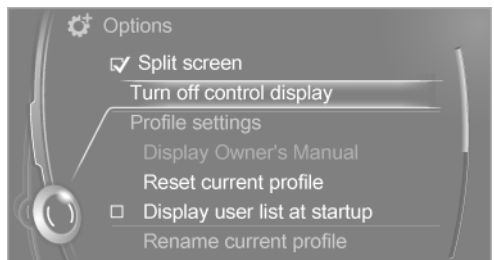

Controller

The buttons can be used to open the menus directly. The controller can be used to select menu items and enter the settings.

Some iDrive functions can be operated using the touchpad on the controller.

1. Turn.

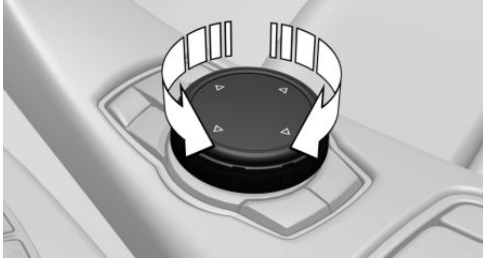

2. Press.

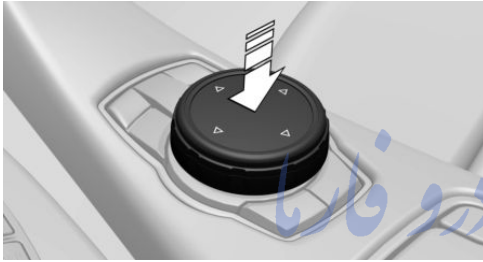

3. Move in four directions.

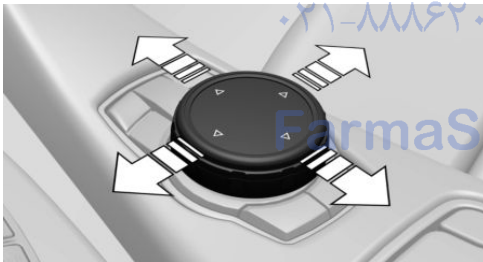

Buttons on controller

Press button	Function
MENU	Open the main menu.
RADIO	Opens the Radio menu.
MEDIA	Opens the Multimedia menu.
NAV	Opens the Navigation menu.
TEL	Opens the phone menu.

Press button	Function
BACK	Displays the previous panel.
OPTION	Opens the Options menu.

Operating concept

Opening the main menu

 Press button.

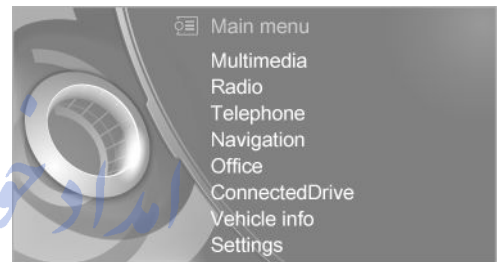

The main menu is displayed.

All iDrive functions can be called up via the main menu.

Selecting menu items

Highlighted menu items can be selected.

1. Turn the controller until the desired menu item is highlighted.



2. Press the controller.

Menu items in the Owner's Manual

In the Owner's Manual, menu items that can be selected are set in quotation marks, e.g., "Settings".

Changing between panels

After a menu item is selected, e.g., "Radio", a new panel is displayed. Panels can overlap.

- ▷ Move the controller to the left.
 - Closes current display and shows previous display.
 - Reopens previous display by pressing BACK button. In this case, the current panel is not closed.
- ▷ Move the controller to the right.
 - Opens new display on top of previous screen.

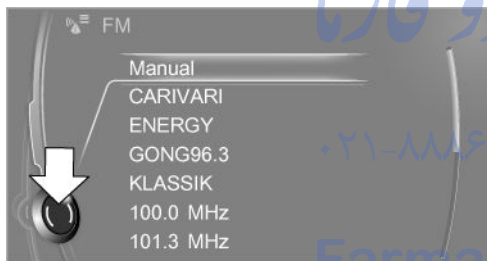

White marks to the left or right indicate that additional panels can be opened.

Display of an opened menu

When selecting a menu, it generally opens with the panel that was last selected in that menu. To display the first panel of a menu:

- ▷ Move the controller to the left repeatedly until the first panel is displayed.
- ▷ Press the menu button on the controller twice.

Opening the Options menu

 Press button.

The "Options" menu is displayed.



Additional options: move the controller to the right repeatedly until the "Options" menu is displayed.

Options menu

The "Options" menu consists of various areas:

- ▷ Screen settings, e.g., "Split screen".
 - This area remains unchanged.
- ▷ Control options for the selected main menu, e.g., for "Radio".
- ▷ If applicable, further operating options for the selected menu, e.g., "Store station".

Changing settings

1. Select a field.
2. Turn the controller until the desired setting is displayed.

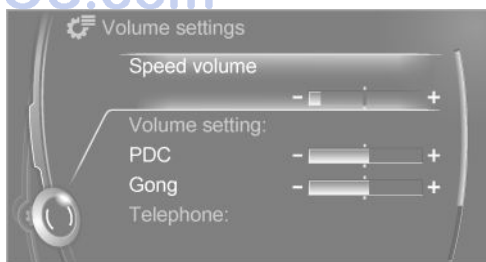

3. Press the controller.

Activating/deactivating the functions

Several menu items are preceded by a check-box. It indicates whether the function is activated or deactivated. Selecting the menu item activates or deactivates the function.

Function is activated.

- Function is deactivated.

Touchpad

Some iDrive functions can be operated using the touchpad on the controller:

Selecting functions

- "Settings"
- "Touchpad"
- Select the desired function.
 - "Speller": enter letters and numbers.
 - "Interactive map": viewing the interactive map.
 - "Browser": enter Internet addresses.
 - "Audio feedback": pronounces entered letters and numbers.

Entering letters and numbers

Entering letters requires some practice at the beginning. When entering, pay attention to the following:

- For the input of upper/lower case letters and numbers, it may be necessary to reel via the controller to the corresponding Input mode, refer to page 24, e.g. when the spelling of upper and lower case letters is identical.
- Enter characters as they are displayed on the Control Display.
- Always enter associated characters, such as accents or periods so that the letter can be clearly recognized. Possible input depends on the set language. Where necessary, enter special characters via the controller.
- To delete a character, slide to the left on the touchpad.
- To enter a blank space, slide to the right in the center of the touchpad.
- To enter a hyphen, slide to the right in the upper area of the touchpad.

- To enter an underscore, swipe to the right in the lower area of the touchpad.

Using interactive map and Internet

Via touch-pad move the interactive map in the navigation system and Internet sites.

Function	Controls
Move interactive map or Internet sites.	Swipe into respective direction.
Enlarge/shrink interactive map or Internet sites.	Drag in or out on the touchpad with fingers.
Display the menu or open a link in the Internet.	Tap once.

Changing settings

You may change control display settings via touchpad. Swipe left or right accordingly.

Example: setting the clock

Setting the clock

On the Control Display:

-  Press button. The main menu is displayed.
- Turn the controller until "Settings" is highlighted, and then press the controller.

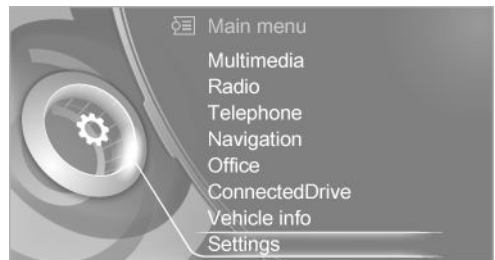

- If necessary, move the controller to the left to display "Time/Date".

- Turn the controller until "Time/Date" is highlighted, and then press the controller.

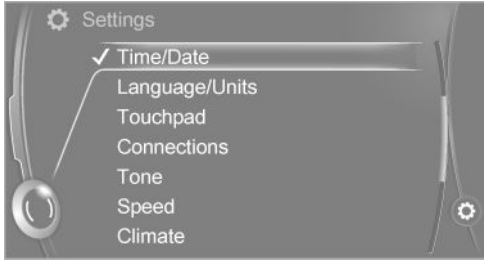

- Turn the controller until "Time:" is highlighted, and then press the controller.

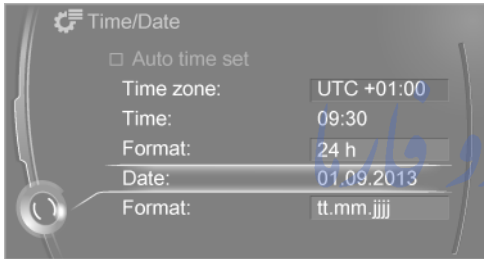

- Turn the controller to set the hours and press the controller.
- Turn the controller to set the minutes and press the controller.

Status information

Status field

The following information is displayed in the status field at the top right:

- ▷ Time.
- ▷ Current entertainment source.
- ▷ Sound output, on/off.
- ▷ Locating the vehicle.
- ▷ Wireless network reception strength.
- ▷ Phone status.
- ▷ Traffic bulletin reception.

Status field symbols

The symbols are grouped as follows.

Radio symbols

Symbol	Meaning
	HD Radio station is being received.



Telephone symbols

Symbol	Meaning
	Incoming or outgoing call.
	Missed call.
	Wireless network reception strength.
	Symbol flashes: network search.
	Wireless network is not available.
	Bluetooth is switched on.
	Roaming is active.
	Text message was received.
	Check the SIM card.
	SIM card is blocked.
	SIM card is missing.
	Enter PIN.

Entertainment symbols

Symbol	Meaning
	Music collection.
	Gracenote® database.
	AUX-IN port.
	USB audio interface.
	Mobile phone audio interface.

Additional symbols

Symbol	Meaning
	Spoken instructions are turned off.
	Check the current vehicle position.

Split screen

General information

Additional information can be displayed on the right side of the split screen, e.g., information from the on-board computer.

In the divided screen view, the so-called split screen, this information remains visible even when you change to another menu.

Switching the split screen on and off

On the Control Display:

-  Press button.
- "Split screen"

Selecting the display

On the Control Display:

-  Press button.
- "Split screen"
- Move the controller until the split screen is selected.

- Press the controller or select "Split screen content".
- Select the desired menu item.

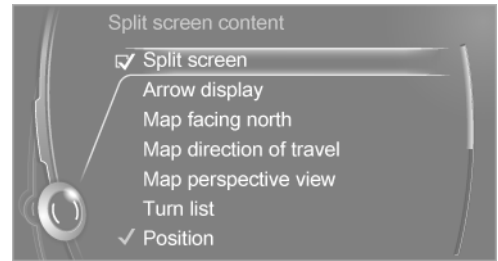



Programmable memory buttons

General information



The iDrive functions can be stored on the programmable memory buttons and called up directly, e.g., radio stations, navigation destinations, phone numbers and menu entries.

Settings are stored for the profile currently in use.

Saving a function

- Highlight the function via the iDrive.
- ... Press and hold the desired button, until a signal sounds.

Running a function

- ... Press button.
The function will work immediately. This means, e.g., that the number is dialed when a phone number is selected.

Displaying the button assignment

Touch buttons with bare fingers. Do not wear gloves or use objects.

The key assignment is displayed at top edge of screen.



Deleting the button assignments

1. Press buttons 1 and 8 simultaneously for approx. five seconds.
2. "OK"

Deleting personal in the vehicle

The concept

Depending on the usage, the vehicle saves personal data, such as stored radio stations. These personal data can be permanently deleted through iDrive.

General information

Depending on the equipment package, the following data can be deleted:

- ▷ Personal Profile settings.
- ▷ Stored radio stations.
- ▷ Stored Favorites buttons.
- ▷ Travel and computer information.
- ▷ Music collection.
- ▷ Navigation, e.g. stored destinations.
- ▷ Phone book.
- ▷ Online data, e.g. Favorites, cookies.
- ▷ Voice notes.
- ▷ Login accounts.
- ▷ RemoteApp smartphone tethering.

Altogether, the deletion of the data can take up to 30 minutes.

Functional requirement

Data can only be deleted while stationary.

Deleting data

Heed and follow the instructions on the Control Display.

1. Turn on operations.
2. "Settings"
3. Open "Options".
4. "Delete personal data"
5. "Continue"
6. "OK"

Entering letters and numbers

General information

On the Control Display:

1. Turn the controller: select letters or numbers.
2. Select additional letters or numbers if needed.
3. "OK": confirm the entry.

Symbol	Function
⬅	Press the controller: delete the letter or number.
⬅	Press the controller for an extended period: delete all letters or numbers.

Switching between cases, letters and numbers

Depending on the menu, you can reel between entering upper and lower case, letters and numbers:

Symbol	Function
A^BC	Enter the letters.
1@+	Enter the numbers.
abc or ABC	Tip controller up.

Without navigation system

@^A A^a a[@] Select the symbol.

Entry comparison

Entering names and addresses: choice is narrowed down with every letter entered and letters may be added automatically.

Entries are continuously compared with data stored in the vehicle.

- ▶ Only those letters are offered during input for which data is available.
- ▶ Target search: names of locations may be entered in languages available through Control Display.

تلفن شبانه روزی: ۰۲۱-۸۸۸۶۲۰۸۵

FarmaSOS.com

Voice activation system

Vehicle features and options

This chapter describes all standard, country-specific and optional features offered with the series. It also describes features that are not necessarily available in your car, e. g., due to the selected options or country versions. This also applies to safety-related functions and systems. The respectively applicable country provisions must be observed when using the respective features and systems.

The concept

- ▷ Most functions displayed on the Control Display can be operated by voice commands via the voice activation system. The system supports you with announcements during input.
- ▷ Functions that can only be used when the vehicle is stationary cannot be used via the voice activation system.
- ▷ The system uses a special microphone on the driver's side.
- ▷ ›...‹ Verbal instructions in the Owner's Manual to use with the voice activation system.

Requirements

Via the Control Display, set a language that is also supported by the voice activation system so that the spoken commands can be identified.

Set the language, refer to page 90.

Using voice activation

Activating the voice activation system

1.  Press button on the steering wheel.
2. Wait for the signal.
3. Say the command.

A command that is recognized by the voice activation system is announced and displayed in the instrument cluster.

 This symbol in the instrument cluster indicates that the voice activation system is active.

If no other commands are available, use function via iDrive.

Terminating the voice activation system

 Briefly press the button on the steering wheel or ›Cancel‹.

Possible commands

Most menu items on the Control Display can be voiced as commands.

The available commands depend on the menu that is currently displayed on the Control Display.

There are short commands for many functions.

You may select lists such as phone lists via voice activation. Read these lists out loud exactly as they show in the respective list.

Having possible commands read aloud

You can have available commands read out loud for you: ›Voice commands‹

E. g. if the "Settings" menu is displayed, the commands for the settings are read out loud.

Executing functions using short commands

Execute functions on the main menu via short commands. It almost doesn't matter which menu item is selected, e.g., ›Vehicle status‹.

Help dialog for the voice activation system

Calling up help dialog: ›Help‹

Additional commands for the help dialog:

- ▶ ›Help with examples‹: announces information about the current operating options and the most important commands for them.
- ▶ ›Help with voice activation‹: information about the principle of operation for the voice activation system is announced.

One example: open the tone settings

Via the main menu

The commands of the menu items are spoken just as they are selected via the controller.

1. Turn on the Entertainment sound output if needed.
2.  Press button on the steering wheel.
3. ›Radio‹
4. ›Tone‹

Via short command

The desired tone settings can also be started via a short command.

1. Turn on the Entertainment sound output if needed.
2.  Press button on the steering wheel.
3. ›Tone‹

Setting the voice dialog

Set system to standard dialog or use a short version.

The short version of the voice dialog plays back short messages in abbreviated form.

1. "Settings"
2. "Language/Units"
3. "Speech type:"
4. Select setting.

Adjusting the volume

Turn the volume button while giving an instruction until the desired volume is set.

- ▶ The volume remains constant even if the volume of other audio sources is changed.
- ▶ The volume is stored for the profile currently in use.

Hints on Emergency Requests

Do not use the voice activation system to initiate an Emergency Request. In stressful situations, the voice and vocal pitch can change. This can unnecessarily delay the establishment of a phone connection.

Instead, use the SOS button, refer to page 183, close to the interior mirror.

Environmental conditions

- ▶ Say the commands, numbers, and letters smoothly and with normal volume, emphasis, and speed.
- ▶ Always say commands in the language of the voice activation system.
- ▶ Keep the doors and windows closed to prevent noise interference.

- ▷ Avoid making other noise in the vehicle while speaking.

امداد خودرو فارما

تلفن شبانه روزی: ۰۲۱-۸۸۸۶۲۰۸۵

FarmaSOS.com

Integrated Owner's Manual in the vehicle

Vehicle features and options

This chapter describes all standard, country-specific and optional features offered with the series. It also describes features that are not necessarily available in your car, e. g., due to the selected options or country versions. This also applies to safety-related functions and systems. The respectively applicable country provisions must be observed when using the respective features and systems.

Integrated Owner's Manual in the vehicle

The Integrated Owner's Manual can be displayed on the Control Display. It specifically describes features and functions found in the vehicle.

Components of the Integrated Owner's Manual

The Integrated Owner's Manual consists of three parts, which offer various levels of information or possible access.

Quick Reference Guide

The Quick Reference Guide provides information how to operate the car, how to use basic vehicle functions or what to do in case of a breakdown. This information can also be displayed while driving.

Search by images

Image search provides information and descriptions. This is helpful when the terminology for a feature is not at hand.

Owner's Manual

Search for information and descriptions by entering terms selected from the index.

Select components

1.  Press button.
2. Turn the controller: open "Vehicle info".
3. Press the controller.
4. Selecting desired range:
 - ▷ "Quick reference"
 - ▷ "Search by pictures"
 - ▷ "Owner's Manual"

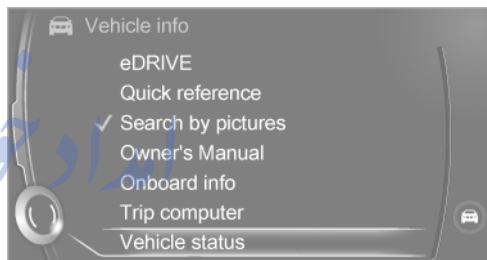

Leafing through the Owner's Manual

Page by page with link access

Turn the controller until the next or previous page is displayed.

Page by page without link access

Scroll through the pages directly while skipping the links.

Highlight the symbol once. Now simply press the controller to browse from page to page.



Scroll back.



Scroll forward.

Context help - Owner's Manual to the temporarily selected function

You may open the relevant information directly.

Opening via the iDrive

To move directly from the application on the Control Display to the Options menu:

1.  Press button or move the controller to the right repeatedly until the "Options" menu is displayed.
2. "Display Owner's Manual"



Opening when a Check Control message is displayed

Directly from the Check Control message on the Control Display:

"Display Owner's Manual"

Changing between a function and the Owner's Manual

To reel from a function, e. g., radio, to the Owner's Manual on the Control Display and to alternate between the two displays:

1.  Press button or move the controller to the right repeatedly until the "Options" menu is displayed.
2. "Display Owner's Manual"
3. Select the desired page in the Owner's Manual.
4.  Press button again to return to last displayed function.
5.  Press button to return to the page of the Owner's Manual displayed last.

To alternate permanently between the last displayed function and the Owner's Manual repeat steps 4 & 5. Opens a new display every time.

Programmable memory buttons

General information

The Owner's Manual can be stored on the programmable memory buttons and called up directly.

Storing

1. "Owner's Manual" Select via the iDrive.
2.  Press selected button for more than 2 seconds.

Executing

1.  Press button. The Owner's Manual is displayed immediately.

امداد خودرو فارما

تلفن شبانه روزی: ۰۸۵ ۸۸۶۲۰۸۵

FarmaSOS.com

BMW eDRIVE

Vehicle features and options

This chapter describes all standard, country-specific and optional features offered with the series. It also describes features that are not necessarily available in your car, e. g., due to the selected options or country versions. This also applies to safety-related functions and systems. The respectively applicable country provisions must be observed when using the respective features and systems.

BMW eDRIVE

Special features of the BMW i

High-voltage system

This BMW i is a hybrid vehicle. In addition to the combustion engine, the vehicle features a high-voltage system that consists of an electric motor and a high-voltage battery among other things.

Carbon body

The vehicle consists of two different functional units: the drive module made from aluminum and the life module made from carbon fiber reinforced plastic (carbon).

At a glance

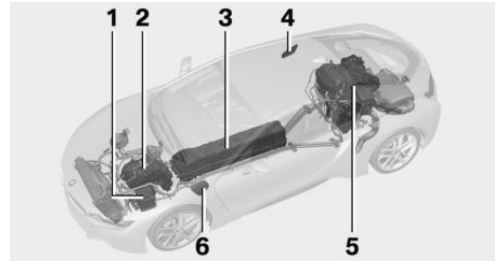

- 1 Vehicle battery
- 2 Electrical drive unit
- 3 High-voltage battery
- 4 Fuel filler flap
- 5 Combustion engine
- 6 Charging port

The concept

The hybrid system makes it possible to optimize fuel consumption and driving characteristics.

An electric motor assists the combustion engine. In certain driving situations, the vehicle can also be driven using only electric power, thereby reducing fuel consumption.

In addition to this, the electric motor acts like an alternator: during braking and coasting, it converts the vehicle's kinetic energy into electricity. The current is stored in the high-voltage battery and is used to drive the electric motor.

Functions

Acceleration boost: ASSIST and eBOOST

Driving off and accelerating require a lot of energy. To reduce fuel consumption during high acceleration and to optimize acceleration, the electric motor supports the combustion en-

gine. For this purpose, the electric motor is supplied by the high-voltage battery.

Electric driving: ePOWER

Under certain conditions, refer to page 64, the vehicle is powered only by the electric motor.

Variable drive configuration

The electric motor drives the front axle and the combustion engine the rear axle. Depending on the operating condition, the vehicle has the options of front-wheel drive, rear-wheel drive or bundled for four-wheel drive.

Follow instructions for electric driving eDRIVE, refer to page 64, driving with the combustion engine DRIVE, refer to page 65, and driving stability, refer to page 109.

Acoustic pedestrian protection

Depending on the country variant, the system generates continuous driving noise, refer to page 65, during electric driving up to approx. 20 mph/30 km/h.

Driving with the combustion engine: POWER

The combustion engine provides the performance to move the vehicle. If necessary, the high-voltage battery is charged at the same time.

The hybrid system always starts the combustion engine automatically.

Energy recovery: CHARGE

The high-voltage battery is charged while driving through energy recovery.

The electric motor acts as a generator and converts the kinetic energy of the vehicle into electric current.

Charging can take place in various situations while the vehicle is in motion:

- ▶ When the vehicle is rolling if the accelerator pedal is not pressed.
- ▶ During vehicle braking.

When exerting gentle pressure on the brakes, the vehicle is only braked by the electric motor. When the brake pedal is depressed further, the brake system is activated additionally. This is why only part of the brake energy is used to charge the high-voltage battery when exerting firm pressure on the brake.

The mark in the instrument cluster is located within the CHARGE range.

Sensible driving and early speed reduction are important to make full use of the energy recovery feature.

Display

The eDRIVE displays, refer to page 75, provide information about the current state of the drive and visualize the system's use in a diagram.

Energy-saving driving

To save energy while driving, read the following information:

Before driving

eDRIVE allows using the air conditioner even before driving off. The stationary climate control, refer to page 127, provides more range than full air conditioning while driving.

Parked car ventilation during the charging process can provide maximum range when driving off.

During driving

- ▶ General driving tips, refer to page 144, for increasing the range.
- ▶ Use the eDRIVE system efficiently, refer to page 138, for an optimized driving style.
- ▶ ECO PRO mode, refer to page 145, for increasing the range.

- Display of hybrid system utilization, refer to page 78
- Hints for saving fuel, refer to page 144, for reduction of the fuel consumption.

After the trip

- Charge vehicle, refer to page 150, and plan next trip.
- Prepare for long downtimes, refer to page 190.

BMW i Remote app

A special BMW i Remote App allows to control and display certain vehicle functions using a smartphone.

Safety information

Read the information on safe handling of the high-voltage system, refer to page 34.

Long-term

Follow the instructions for vehicle storage and for longer idle periods, refer to page 190.

FarmaSOS.com

Safety of the high-voltage system

Safety of the high-voltage system

Working on the vehicle



Maintenance and repairs

Have maintenance and repair work performed only by a service center or a workshop that works according to BMW specifications with appropriately trained personnel. Otherwise, there is the risk of fatal injury from electrocution due to the high-voltage system's high voltage. ◀



Body work and working on the high-voltage system

Do not perform any modifications or work on the vehicle, especially maintenance and repair work on the high-voltage system and the carbon body and avoid retrofitting accessories.

If work is not carried out properly, there is the risk of fire and fatal injury from electrocution due to the high-voltage system's high voltage.

BMW recommends to have modifications and work on the vehicle only be carried out by an authorized BMW i service center or one that operates according to BMW i specifications with personnel trained accordingly. ◀

Your vehicle's high-voltage system is a self-contained system. Safety is ensured as long as no work is performed on technical components or on the chassis.

High-voltage system: contact with water

The high-voltage system is typically safe even in the following example situations:

- ▷ Water in the footwell, for instance after a rainstorm when sunroof was kept open.
- ▷ Vehicle is in water but only up to the allowed height.

- ▷ Liquid escapes in the trunk.

In these cases there is no risk of injury from electrocution. Other damage to the vehicle is possible.

High-voltage system: automatic deactivation

If an accident occurs, the high-voltage system is switched off automatically to prevent risk of danger to occupants and other traffic.

Read the information on What to do after an accident, refer to page 186.

امداد خودرو فارما

تلفن شبانه روزی: ۰۲۱-۸۸۸۶۲۰۸۵

FarmaSOS.com



امداد خودرو فارما

تلفن مشاوره و خرید: ۰۲۱-۸۸۸۶۲۰۸۵

FarmaSOS.com

Controls

This chapter is intended to provide you with information that will give you complete control of your vehicle. All features and accessories that are useful for driving and your safety, comfort and convenience are described here.

امداد خودرو فارما

تلفن: ۰۲۱-۸۸۶۲۰۸۵

FarmaSOS.com

Opening and closing

Vehicle features and options

This chapter describes all standard, country-specific and optional features offered with the series. It also describes features that are not necessarily available in your car, e. g., due to the selected options or country versions. This also applies to safety-related functions and systems. The respectively applicable country provisions must be observed when using the respective features and systems.

Remote control/key

General information

The vehicle is supplied with two remote controls with integrated key.

Every remote control holds a replaceable battery.

You may set the key functions depending on the optional features and country-specific version. For Settings, refer to page 46.

The vehicle stores personal settings for every remote control. Personal Profile, refer to page 39.

The remote controls hold information on required maintenance. Service data in the remote control, refer to page 178

At a glance

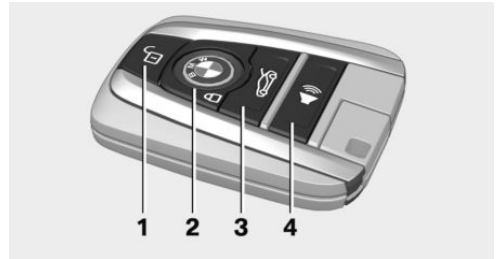

- 1 Unlocking
- 2 Locking
- 3 Unlock the tailgate
- 4
 - ▶ With alarm system: panic mode
 - ▶ Without panic mode: 
 Adjustable function: headlamp courtesy delay feature or stationary climate control.

Integrated key



Press button, arrow 1, and remove the key, arrow 2.

The integrated key fits the driver's door lock.

Replacing the battery



1. Remove integrated key from remote control.
2. Raise the cover of the battery compartment, arrow 1.
3. Remove the cover of the battery compartment, arrow 2.
4. Insert a battery of the same type with the positive side facing up.
5. Press the cover closed.



Take the used battery to a recycling center or to your service center.

New remote controls

New remote controls are available from the service center.

Loss of the remote controls

Lost remote controls can be disabled by your service center.

Emergency detection of remote control

Also in the following situations, radio-ready state and drive readiness can be established:

- ▶ Interference of radio transmission to remote control by external sources e.g., by radio masts.
- ▶ Empty battery in remote control.
- ▶ Interference from radio transmissions through mobile devices in close proximity to remote control.

- ▶ Interference of radio transmission by charger while charging items such as mobile devices in the vehicle.

A Check Control message is displayed if one attempts to turn on the radio-ready state or activate engine readiness.

Activation of drive readiness via emergency detection of the remote control

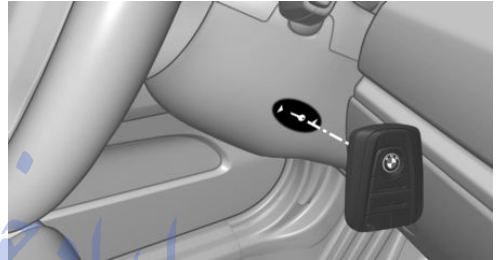

If a respective Check Control message appears, hold the remote control with its back against the marked area on the steering column. The BMW logo on the remote control should be at the same height as the marked area. Press the Start/Stop button within 10 seconds while pressing the brake pedal.

If the remote control is not recognized: slightly change the height position of the remote control and repeat the procedure.

Personal Profile

The concept

Personal Profile provides three profiles, using which personal vehicle settings can be stored. Every remote control has one of these profiles assigned.

If the vehicle is unlocked using a remote control, the assigned personal profile will be activated. All settings stored in the profile are automatically applied.

If several drivers use their own remote control, the vehicle will adjust the personal settings

during unlocking. These settings are also re-stored, if the vehicle has been used in the meantime by a person with a different remote control.

Changes to the settings are automatically saved in the personal profile.

Three personal profiles and a guest profile can be created.

Adjusting

The settings for the following systems and functions are saved in the active profile. The scope of storable settings is country- and equipment-dependable.

- ▷ Unlocking and locking.
- ▷ Lights.
- ▷ Climate control.
- ▷ Radio.
- ▷ Instrument cluster.
- ▷ Programmable memory buttons.
- ▷ Volumes, tone.
- ▷ Control Display.
- ▷ Navigation.
- ▷ Park Distance Control PDC.
- ▷ Head-up Display.
- ▷ Driving Dynamics Control.
- ▷ Intelligent Safety.

Profile management

Opening profiles

Regardless of the remote control in use a different profile may be activated.

1. "Settings"
 2. "Profiles"
 3. Select a profile.
- ▷ All settings stored in the called-up profile are automatically applied.
 - ▷ The called-up profile is assigned to the remote control being used at the time.

- ▷ If the profile is already assigned to a different remote control, this profile will apply to both remote controls. It cannot be differentiated anymore between the settings for the two remote controls.

Renaming profiles

A personal name can be assigned to every profile to avoid confusion between the profiles.

1. "Settings"
2. "Profiles"
3. "Options"
4. "Rename current profile"

Resetting profiles

The settings of the active profile are reset to their default values.

1. "Settings"
2. "Profiles"
3. "Options"
4. "Reset current profile"

Exporting profiles

Most settings of the active profile can be exported.

This can be helpful for securing and retrieving personal settings, before delivering the vehicle to a workshop, e.g. Profiles can be taken to another vehicle equipped with the Personal Profile function.

The following export options are available:

- ▷ Via BMW Online.
 - ▷ Via the USB port to a USB device.
- Popular file systems for USB devices are supported. FAT32 and exFAT are the recommended formats for profile export. Other formats may not support the export.
1. "Settings"
 2. "Profiles"

3. "Export profile"
4. BMW Online: "BMW Online"
USB interface: "USB device"

Alternatively, the settings and contacts can be exported via an app to a suitable smartphone.

Importing profiles

Profiles exported via BMW Online can also be imported via BMW Online.

Profiles stored on a USB device can be imported via the USB interface.

Existing settings are overwritten with the imported profile.

1. "Settings"
2. "Profiles"
3. "Import profile"
4. BMW Online: "BMW Online"
USB interface: "USB device"

Alternatively, the settings and contacts can be imported via an app from a suitable smartphone.

Using the guest profile

The guest profile is for individual settings that are saved in none of the three personal profiles.

This can be useful for drivers who are using the vehicle temporarily and do not have their own profile.

1. "Settings"
2. "Profiles"
3. "Guest"

The guest profile cannot be renamed. It is not assigned to the current remote control.

Display profile list during start

The profile list can be displayed during each start to select the desired profile.

1. "Settings"
2. "Profiles"

3. "Options"
4. "Display user list at startup"

LED in the driver's door

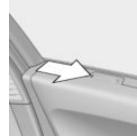

The signals of the LED have the following meanings:

- ▷ 1x flashing: door is locked.
The LED then still lights up for a certain time, if the vehicle was locked from the outside.
The LED then lights up permanently, if the vehicle was locked from the inside or automatically while driving off.
- ▷ 2x flashing: door is unlocked.
- ▷ More than 2x flashing: door malfunction. In this case, contact the service center.

Using the remote control

Note

 Take the remote control with you. People or animals left unattended in a parked vehicle can lock the doors from the inside. Always take the remote control with you when leaving the vehicle so that the vehicle can then be opened from the outside. ◀

Unlocking

 Press button on the remote control.

- ▷ All doors and the tailgate are being unlocked.
- ▷ The interior lamps are switched on. This function is not available, if the interior lamps were switched off manually.
- ▷ The welcome lamps are switched on, if this function was activated.

- ▶ Exterior mirrors folded through convenient closing are folded open.

You can set how the vehicle is to be unlocked. For Settings, refer to page 46.

Anti-theft protection is switched off.

The alarm system, refer to page 47, is disarmed.

Convenient opening



Press and hold this button on the remote control after unlocking.

The windows are opened, as long as the button on the remote control is pressed.

Locking



Locking from the outside

Do not lock the vehicle from the outside with people inside the car, as the vehicle cannot be unlocked from inside without special knowledge. ◀

The driver's door must be closed.



Press button on the remote control.

All doors and the tailgate are being locked.

Anti-theft protection is switched on. It prevents the doors from being unlocked using the door openers.

The alarm system, refer to page 47, is armed.

Switching on interior lights



Press button on the remote control with the vehicle locked.

This function is not available, if the interior lamps were switched off manually.

If the button is pressed again within 10 seconds after vehicle was locked, the interior motion sensor and tilt alarm sensor of the anti-theft warning system, refer to page 48, are turned off. After locking, wait 10 seconds before pressing the button again.

Unlocking the tailgate



Press button on the remote control for approx. 1 second.

The tailgate opens slightly, regardless of whether the vehicle was previously locked or unlocked.

Depending on the features and the country version, it is also possible to have door unlocked. Create the settings, refer to page 46.

If the doors were not unlocked, the tailgate is locked again as soon as it closes.



Do not place the remote control in the cargo area

Take the remote control with you and do not leave it in the cargo area; otherwise, the remote control is locked inside the vehicle when the tailgate is closed. ◀



Provide edge protection

Sharp objects or those with edges can hit the rear window while driving and damage the heat conductors of the rear window. Provide edge protection. ◀

Without alarm system: switching the headlamp courtesy delay feature on

The headlight courtesy delay feature function must be set for the remote control button. For Settings, refer to page 46.



Briefly press the button on the remote control.

The duration can be set in the Control Display.

With alarm system: panic mode

You can trigger the alarm system if you find yourself in a dangerous situation.



Press button on the remote control for at least 3 seconds.

To reel off the alarm: press any button.

Malfunction

Remote control detection by the vehicle can among others be malfunctioning under the following circumstances:

- ▶ The battery of the remote control is discharged. Replace the battery, refer to page 39.
- ▶ Interference of the radio connection from transmission towers or other equipment with high transmit power.
- ▶ Shielding of the remote control due to metal objects.
- ▶ Interference of the radio connection from mobile phones or other electronic devices in direct proximity.

Do not transport the remote control together with metal objects or electronic devices.

In the case of interference, the vehicle can also be unlocked and locked from the outside without remote control, refer to page 43.

For US owners only

The transmitter and receiver units comply with part 15 of the FCC/Federal Communication Commission regulations. Operation is governed by the following:

FCC ID:

- ▶ LX8766S.
- ▶ LX8766E.
- ▶ LX8CAS.
- ▶ LX8CAS2.
- ▶ MYTCAS4.

Compliance statement:

This device complies with part 15 of the FCC Rules. Operation is subject to the following two conditions:

- ▶ This device may not cause harmful interference, and
- ▶ this device must accept any interference received, including interference that may cause undesired operation.

Any unauthorized modifications or changes to these devices could void the user's authority to operate this equipment.

Without remote control

Locking from the outside

1. Close the driver's door from the outside.
2. Enter the vehicle via the front passenger side and close front passenger door.



3. Press button for central locking system.

Vehicle is locked.

4. Unlock the front passenger door via the lever in the door frame, refer to page 44.

5. Exit the vehicle on the front passenger side:

Make sure that the remote control is not in the vehicle.

6. Close the front passenger door.

Unlocking from the outside



The driver's door can be opened at the door lock using the integrated key, refer to page 38.

The alarm system is set off when the vehicle is opened using the door lock.



In order to terminate this alarm, unlock vehicle with the remote control or establish radio-ready state, if needed, through emergency detection of the remote control, refer to page 39.

From the inside

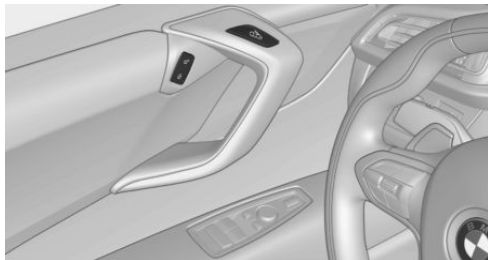
Unlocking and locking



Via the buttons for the central locking system.

- ▷  By pressing the button, the vehicle is locked with the doors closed.
- ▷  Pressing the button unlocks the vehicle.

The vehicle is not secured against theft when locking.

In the event of a severe accident, the vehicle is automatically unlocked. The hazard warning system and interior lights come on.

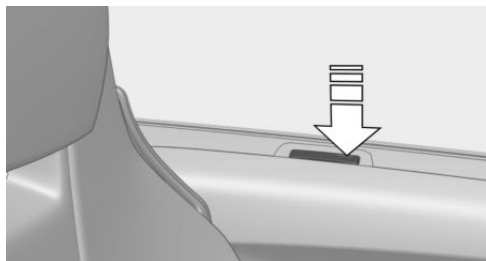

When there is a power failure or to unlock the door from the rear: first push down on the lever in the door frame in the front area, arrow. The lever is raised.

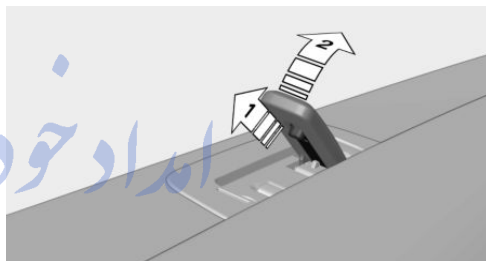

Pull the release on the bottom of the lever upwards, arrow 1, then push the lever forwards, arrow 2.

Unlocking and opening



Press button.

The door is unlocked and slightly open. Push the door outward.



Note swivel range of the door.

The folding doors swivel to the side and upward. Before opening, make sure that the swivel range is clear. Otherwise, the doors can be damaged. ◀

FarmaSOS.com

Hood

The hood should only be opened by the service center.

Tailgate

Opening

The tailgate swings back and up when it opens.

Ensure that adequate clearance is available before opening.

Opening from the outside

- ▷  Press button on the remote control for approx. 1 second.

As the case may be, the doors are also unlocked. Unlocking with the remote control, refer to page 42.

The tailgate is unlocked and can be swung upward.

Opening from the inside



With the vehicle is stationary, press the button in the door armrest.

Closing

Hints



Keep the closing path clear

Make sure that the closing path of the tailgate is clear; otherwise, injuries may result. ◀



Do not place the remote control in the cargo area

Take the remote control with you and do not leave it in the cargo area; otherwise, the remote control is locked inside the vehicle when the tailgate is closed. ◀



Provide edge protection

Sharp objects or those with edges can hit the rear window while driving and damage the heat conductors of the rear window. Provide edge protection. ◀

Emergency unlocking



Pull the handle inside the trunk.

The tailgate is unlocked.

Comfort Access

The concept

The vehicle can be accessed without activating the remote control.

All you need to do is to have the remote control with you, such as in your pants pocket.

The vehicle automatically detects the remote control when it is in close proximity or in the car's interior.

Comfort Access supports the following functions:

- ▷ Unlocking/locking of the vehicle.
- ▷ Convenient closing.
- ▷ Establish drive readiness.

Functional requirements

- ▷ There are no external sources of interference nearby.
- ▷ To lock the vehicle, the remote control must be located outside of the vehicle.
- ▷ The next unlocking and locking cycle is not possible until after approx. 2 seconds.
- ▷ Drive readiness can only be established if the remote control is in the vehicle.

Unlocking

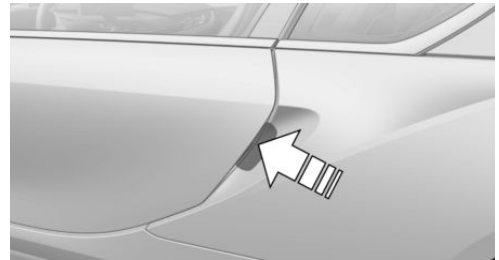

Before pressing the door opener button, draw your hand across the sensor surface, arrow.

This corresponds with pressing the button on the remote control. ☑

Locking

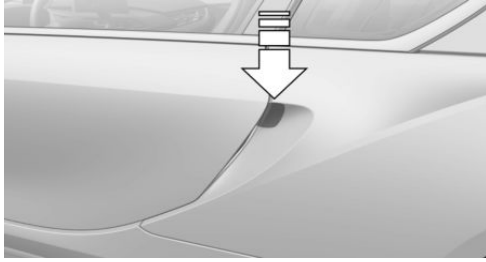

From above, touch the surface on the side wall with your finger for approx. 1 second, arrow.

This corresponds with pressing the button on the remote control. 🔄

To save battery power, ensure that all power consumers are turned off before locking the vehicle.

Convenient closing



Monitor closing

Monitor closing to ensure that no one becomes trapped. ◀

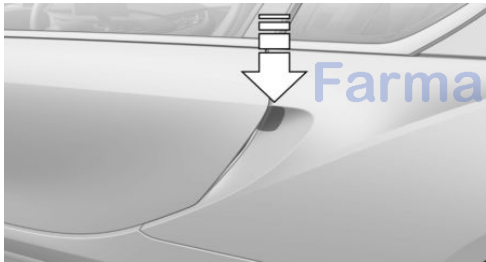

From above, touch the surface on the sidewall with your finger and hold it there, arrow.

This corresponds to pressing and holding 🔄 the remote control button.

Malfunction

Remote control detection by the vehicle can among others be malfunctioning under the following circumstances:

- ▷ The battery of the remote control is discharged. Replace the battery, refer to page 39.
- ▷ Interference of the radio connection from transmission towers or other equipment with high transmit power.
- ▷ Shielding of the remote control due to metal objects.
- ▷ Interference of the radio connection from mobile phones or other electronic devices in direct proximity.

Do not transport the remote control together with metal objects or electronic devices.

In the case of a malfunction, unlock and lock the vehicle using the buttons of the remote control or using the integrated key, refer to page 43.

Adjusting

Unlocking

The settings are saved in the active profile, refer to page 39.

Doors

1. "Settings"
2. "Doors/key"
3. 🗄 Select the symbol.
4. Select the desired function:
 - ▷ "Driver's door only"

Only the driver's door is unlocked. Pressing again unlocks the entire vehicle.
 - ▷ "All doors"

The entire vehicle is unlocked.

Tailgate

Depending on optional features and country version, this setting is not offered in some cases.

1. "Settings"
2. "Doors/key"
3.  Select the symbol.
4. Select the desired function:
 - ▷ "Tailgate"

The tailgate is unlocked.
 - ▷ "Tailgate + door(s)"

The tailgate and the doors are unlocked.

Confirmation signals from the vehicle

The settings are saved in the active profile, refer to page 39.

1. "Settings"
2. "Doors/key"
3. Deactivate or activate the desired confirmation signals.
 - ▷ "Acoustic sig. lock/unlock"
 - ▷ "Flash when lock/unlock"

Automatic locking

The settings are saved in the active profile, refer to page 39.

1. "Settings"
2. "Doors/key"
3. Select the desired function:
 - ▷ "Lock if no door is opened"

The vehicle locks automatically after a short period of time if no door is opened.
 - ▷ "Lock after start driving"

The vehicle locks automatically after you drive off.

Without alarm system: headlamp courtesy delay feature/standing climate control

The settings are saved in the active profile, refer to page 39.

1. "Settings"
2. "Doors/key"
3.  Select the symbol.
4. Select the desired function:
 - ▷ "Pathway lighting"

Headlight courtesy delay feature
 - ▷ "Comfort climate control"

Stationary climate control

Alarm system

The concept

When the vehicle is locked, the vehicle alarm system responds to:

- ▷ Opening a door, the hood or the tailgate.
- ▷ Movements in the interior.
- ▷ Changes in the vehicle tilt, e. g., during attempts at stealing a wheel.
- ▷ Disconnected battery voltage.

The alarm system briefly signals tampering:

- ▷ By sounding an acoustic alarm.
- ▷ By switching on the hazard warning system.
- ▷ By flashing the high beams.

Arming and disarming the alarm system

When you unlock or lock the vehicle, either with the remote control or via the Comfort Access, the alarm system is disarmed or armed at the same time.

Door lock and armed alarm system

The alarm system is triggered when the door is opened, when the vehicle is unlocked via the door lock.

Tailgate and armed alarm system

The tailgate can be opened even when the alarm system is armed.

After the tailgate is closed, it is locked and monitored again when the doors are locked. The hazard warning system flashes once.

Panic mode

You can trigger the alarm system if you find yourself in a dangerous situation.



Press button on the remote control for at least 3 seconds.

To switch off the alarm: press any button.

Indicator lamp on the interior rearview mirror

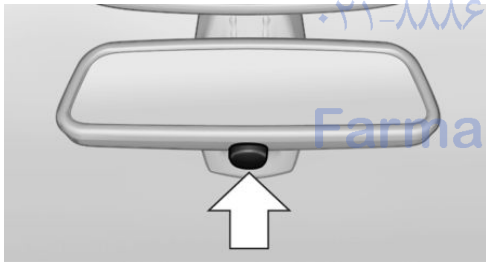

- ▷ The indicator lamp flashes briefly every 2 seconds:
The system is armed.
- ▷ The indicator lamp flashes after locking:
The doors, hood or tailgate is not closed properly, but the rest of the vehicle is secured.
After 10 seconds, the indicator lamp flashes continuously. Interior motion sensor and tilt alarm sensor are not active.

When the still open access is closed, interior motion sensor and tilt alarm sensor will be switched on.

- ▷ The indicator lamp goes out after unlocking:
The vehicle has not been tampered with.
- ▷ The indicator lamp flashes after unlocking until the radio-ready state is switched on, but no longer than approx. 5 minutes:
An alarm has been triggered.

Tilt alarm sensor

The tilt of the vehicle is monitored.

The alarm system responds in situations such as attempts to steal a wheel.

Interior motion sensor

The windows must be closed for the system to function properly.

Avoiding unintentional alarms

The tilt alarm sensor and interior motion sensor can be switched off together, such as in the following situations:

- ▷ In automatic car washes.
- ▷ In duplex garages.
- ▷ During transport on trains carrying vehicles, at sea or on a trailer.
- ▷ With animals in the vehicle.

Switching off the tilt alarm sensor and interior motion sensor



Press the remote control button again within 10 seconds as soon as the vehicle is locked.

The indicator lamp lights up for approx. 2 seconds and then continues to flash.



The tilt alarm sensor and interior motion sensor are turned off, until the vehicle is locked again.

Switching off the alarm

- ▷ Unlock vehicle with the remote control or establish radio-ready state, if needed through emergency detection of remote control, refer to page 39.
- ▷ With Comfort Access: if you are carrying the remote control on your person, touch the sensor surface, refer to page 45, before the door opener button.



Power windows

Hint

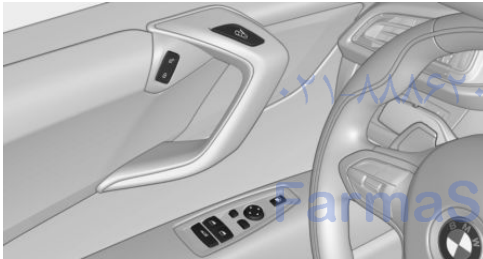
-  Take the remote control with you
-  Take the remote control with you when leaving the vehicle so that children, e.g., cannot operate the power windows and injure themselves. ◀





Opening



- ▷  Press the button to the resistance point.
The window opens while the switch is held.
- ▷  Press the switch beyond the resistance point.
The window opens automatically. Pressing the switch again stops the motion.

See also: Convenient opening, refer to page 42, via remote control.

Closing

-  Keep the closing path clear
-  Monitor closing and make sure that the closing path of the window is clear; otherwise, injuries may result. ◀



To close a window, the corresponding door must be closed.

- ▷  Pull the switch to the resistance point.
The window closes while the switch is held.
 - ▷  Pull the switch beyond the resistance point.
The window closes automatically. Pulling again stops the motion.
- See also: closing by means of Comfort Access, refer to page 45.

Pinch protection system

-  Danger of jamming even with pinch protection



Even with the pinch protection system, check that the window's closing path is clear; otherwise, the closing action may not stop in certain situations, e.g., if thin objects are present. ◀

-  No window accessories
-  Do not install any accessories in the window's range of movement; otherwise, the pinch protection system will be impaired. ◀

If closing force exceeds a specific margin as a window closes, closing is interrupted.

The window reopens slightly.

Closing without the pinch protection system

-  Keep the closing path clear
-  Monitor closing and make sure that the closing path of the window is clear; otherwise, injuries may result. ◀

E.g. danger from the outside or ice might prevent window from closing properly - proceed as follows:

1. Pull the reel past the resistance point and hold it there.
The pinch protection is limited and the window reopens slightly if the closing force exceeds a certain margin.
2. Pull the reel past the resistance point again within approx. 4 seconds and hold it there.
The window closes without jam protection.

امداد خودرو فارما

تلفن شبانه روزی: ۰۲۱-۸۸۸۶۲۰۸۵

FarmaSOS.com

Adjusting

Vehicle features and options

This chapter describes all standard, country-specific and optional features offered with the series. It also describes features that are not necessarily available in your car, e. g., due to the selected options or country versions. This also applies to safety-related functions and systems. The respectively applicable country provisions must be observed when using the respective features and systems.

Sitting safely

The ideal seating position can make a vital contribution to relaxed, fatigue-free driving.

The seating position plays an important role in an accident in combination with:

- Safety belts, refer to page 53.
- Head restraints, refer to page 54.
- Airbags, refer to page 96.

Seats

Hints

 Do not adjust the seat while driving
Do not adjust the driver's seat while driving, or the seat could respond with unexpected movement and the ensuing loss of vehicle control could lead to an accident. ◀

 Do not incline the backrest too far to the rear

Do not incline the backrest too far to the rear while driving, or there is a risk of slipping under the safety belt in the event of an accident. This would eliminate the protection normally provided by the belt. ◀



Keep the movement area unobstructed
When changing the seat position, keep the seat's area of movement unobstructed; otherwise, people might get injured or objects damaged. ◀

Rear seating positions

The vehicle is designed as a 2+2-seater. The utility of the rear seats is limited. In order to keep the risk of an injury during a collision or an accident as small as possible, the top edge of the backrest should be at least just above eye height.

Electrically adjustable seats

At a glance



- 1 Backrest tilt
- 2 Forward/backward, height, seat tilt

Adjustments in detail

1. Forward/back.

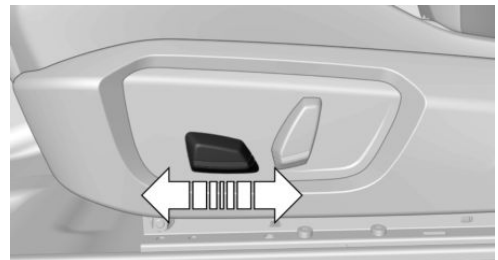

2. Height.

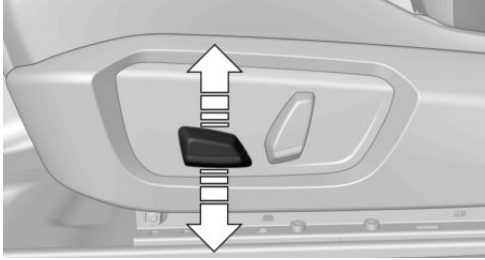

3. Seat tilt.

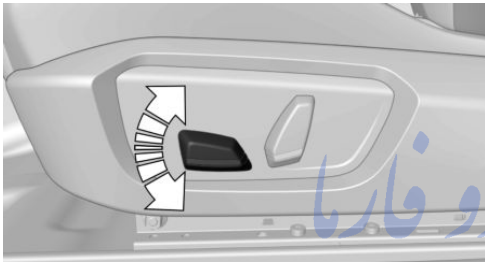

4. Backrest tilt.

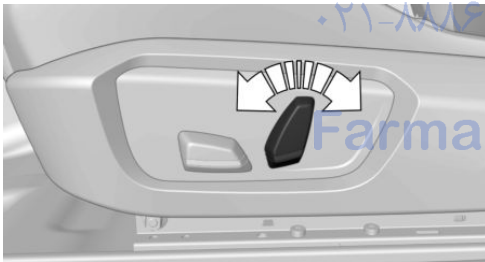

Entering the rear

Note

 Folding back and locking the backrest
Before driving off, fold back and lock the
backrests; otherwise, an unexpected seat
movement may cause an accident. ◀

Fold down seat back

1. Pull lever up to the stop.

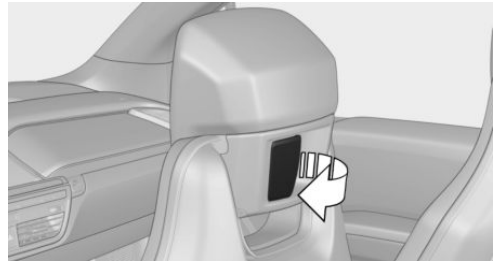

2. Fold backrest forward.

Front seat heating



Switching on



Press button once for each tempera-
ture level.

The maximum temperature is reached when
three LEDs are lit.

If the journey is continued within approx. 15
minutes, the seat heating is activated automat-
ically with the temperature selected last.

When ECO PRO, refer to page 145, is acti-
vated, the heater output is reduced.

Switch off



Press button longer.
The LEDs go out.

Safety belts

Seats with safety belt

The vehicle has four seats, each of which is equipped with a safety belt.

General information

Always make sure that safety belts are being worn by all occupants before driving off.

For the occupants' safety the belt locking mechanism triggers early. Slowly guide the belt out of the holder when applying it.

Although airbags enhance safety by providing added protection, they are not a substitute for safety belts.

The upper shoulder strap's anchorage point will be correct for adult seat occupants of every build if the seat is correctly adjusted.

Hints

 One person per safety belt
Never allow more than one person to wear a single safety belt. Never allow infants or small children to ride on a passenger's lap. ◀

 Putting on the belt
Lay the belt, without twisting, snugly across the lap and shoulders, as close to the body as possible. Make sure that the belt lies low around the hips in the lap area and does not press on the abdomen. Otherwise, the belt can slip over the hips in a frontal impact and injure the abdomen.

The safety belt must not lie across the neck, rub on sharp edges, be routed over breakable objects, or be pinched. ◀

 What reduces the restraining effect
Avoid wearing bulky clothing, and pull the shoulder belt periodically to readjust the tension. Make sure that the belt is not jammed; otherwise, the belt can be damaged and the restraining effect is reduced. ◀

Buckling the belt

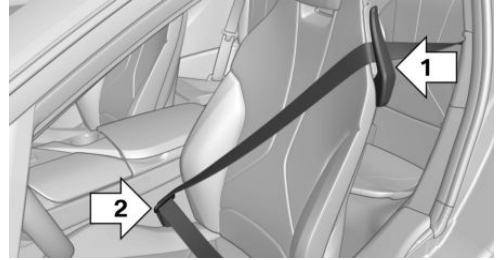

1. Insert belt in the belt buckle, arrow 1.
2. Insert the buckle tongue in the belt buckle, arrow 2.

Make sure you hear the latch plate engage in the belt buckle.

Unbuckling the belt

1. Hold the belt firmly.
2. Press the red button in the belt buckle.
3. Guide the belt back into its roll-up mechanism.

Safety belt reminder for driver's and passenger's seat

 The indicator lamp lights up and a signal sounds. Make sure that the safety belts are positioned correctly. The safety belt reminder is active at speeds above approx. 6 mph/10 km/h. It can also be activated if objects are placed on the front passenger seat.

Damage to safety belts

Wear and tear after accidents or when damaged otherwise:

Have the safety belts, including the safety belt tensioners, replaced and have the belt anchors checked.

 Check and replace safety belts
This should only be done by your service center; otherwise, this safety feature might not work properly. ◀

Front head restraints

Distance

The spacing is adjusted to the back of the head using the incline of the seat backrest.

Adjust the distance so that the head restraint is as close as possible to the back of the head.

Removing

The head restraints cannot be removed.

Mirrors

Exterior mirrors

General information

The mirror on the passenger side is more curved than the driver's side mirror.

Depending on the vehicle equipment, the mirror setting is stored for the profile currently in use. When the vehicle is unlocked via the remote control, the position is automatically retrieved if this function is active.

Note



Estimating distances correctly

Objects reflected in the mirror are closer than they appear. Do not estimate the distance to the traffic behind you based on what you see in the mirror, as this will increase your risk of an accident. ◀

At a glance



- 1 Adjusting 54
- 2 Left/right, Automatic Curb Monitor
- 3 Fold in and out 55

Selecting a mirror



To change over to the other mirror:
Slide the switch.

Adjusting electrically



The setting corresponds to the direction in which the button is pressed.

Adjusting manually

In case of electrical malfunction press edges of mirror.

Automatic Curb Monitor

The concept

If reverse gear is engaged, the mirror glass on the front passenger side is tilted downward. This improves your view of the curb and other low-lying obstacles when parking, e.g.

Activating



1. Slide the switch to the driver's side mirror position.
2. Engage selector lever position R.

Deactivating

Slide the switch to the passenger side mirror position.

Fold in and out

 Press button.

Possible at speeds up to approx. 15 mph/20 km/h.

E. g. this is advantageous

- ▶ In car washes.
- ▶ In narrow streets.
- ▶ For folding mirrors back out that were folded away manually.

Mirrors that were folded in are folded automatically at a speed of approx. 25 mph/40 km/h.

 Fold in the mirror in a car wash

Before washing the car in an automatic car wash, fold in the exterior mirrors by hand or with the button; otherwise, the mirrors could be damaged, depending on the width of the vehicle. ◀

Automatic heating

Both exterior mirrors are automatically heated whenever drive readiness is switched on.

Automatic dimming feature

Both exterior mirrors are automatically dimmed. Photocells are used to control the Interior rearview mirror, refer to page 55.

Interior rearview mirror, manually dimmable

Flip lever

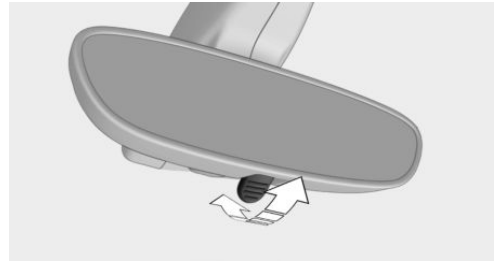

To reduce the blinding effect of the interior rear view mirror, flip the lever forward.

Interior rearview mirror, automatic dimming feature

The concept

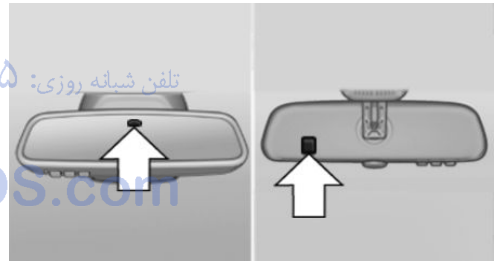

Photocells are used for control:

- ▶ In the mirror glass.
- ▶ On the back of the mirror.

Functional requirement

For proper operation:

- ▶ Keep the photocells clean.
- ▶ Do not cover the area between the inside rearview mirror and the windshield.

Steering wheel

Note



Do not adjust while driving

Do not adjust the steering wheel while driving; otherwise, an unexpected movement could result in an accident. ◀

Adjusting

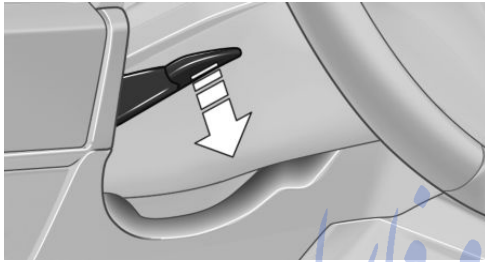

1. Fold the lever down.
2. Move the steering wheel to the preferred height and angle to suit your seating position.
3. Fold the lever back.

تلفن شبانه روزی: ۰۲۱-۸۸۸۶۲۰۸۵

FarmaSOS.com

Transporting children safely

Vehicle features and options

This chapter describes all standard, country-specific and optional features offered with the series. It also describes features that are not necessarily available in your car, e. g., due to

the selected options or country versions. This also applies to safety-related functions and systems. The respectively applicable country provisions must be observed when using the respective features and systems.

The right place for children

Note

 Children in the vehicle

Do not leave children unattended in the vehicle; otherwise, they could endanger themselves and other persons, e.g., by opening the doors. ◀

Children should always be in the rear

Accident research shows that the safest place for children is in the back seat.

 Transporting children in the rear

Only transport children younger than 13 years of age or shorter than 5 ft/150 cm in the rear in child restraint systems provided in accordance with the age, weight and size of the child; otherwise, there is an increased risk of injury in an accident.

Children 13 years of age or older must wear a safety belt as soon as a suitable child restraint system can no longer be used due to their age, weight and size. ◀

Children on the front passenger seat

Should it ever be necessary to use a child restraint system in the front passenger seat, make sure that the front, knee and side airbags on the front passenger side are deactivated. Automatic deactivation of front-seat passenger airbags, refer to page 98.

Note

 Deactivating the front-seat passenger airbags

If a child restraint system is used in the front passenger seat, deactivate the front-seat passenger airbags; otherwise, there is an increased risk of injury to the child when the airbags are activated, even with a child restraint system. ◀

Installing child restraint systems

Hints

 Manufacturer's information for child restraint systems

To select, mount and use child restraint systems, observe the information provided by the system manufacturer; otherwise, the protective effect can be lost. ◀

 Ensuring the stability of the child seat

When installing child restraint systems, make sure that the child seat is securely fastened to the backrest of the seat. Angle and headrest of the backrest might need to be adjusted or possibly be removed. Make sure that all backrests are securely locked. Otherwise the stability of the child seat can be affected, and there is an increased risk of injury because

of unexpected movement of the seat backrest. ◀

On the front passenger seat

Deactivating airbags

 Deactivating the front-seat passenger airbags

If a child restraint system is used in the front passenger seat, deactivate the front-seat passenger airbags; otherwise, there is an increased risk of injury to the child when the airbags are activated, even with a child restraint system. ◀

After installing a child restraint system in the front passenger seat, make sure that the front, knee and side airbags on the front passenger side are deactivated.

Deactivate the front-seat passenger airbags automatically, refer to page 98.

Seat position and height

Before installing a child restraint system, move the front passenger seat as far back as possible and adjust its height to the highest and thus best possible position for the belt and to offer optimal protection in the event of an accident.

If the upper anchorage of the safety belt is located in front of the belt guide of the child seat, move the passenger seat carefully forward until the best possible belt guide position is reached.

LATCH child restraint system

LATCH: Lower Anchors and Tether for Children.

Child seat security



The rear safety belts and the front passenger safety belt can be permanently locked to fasten child restraint systems.

The front passenger safety belt can be permanently locked to fasten child restraint systems.

Locking the safety belt

1. Pull out the strap completely.
2. Secure the child restraint system with the belt.
3. Allow the strap to be pulled in and pull it tight against the child restraint system. The safety belt is locked.

Unlocking the safety belt

1. Unbuckle the belt buckle.
2. Remove the child restraint system.
3. Allow the strap to be pulled in completely.

Note



Follow manufacturer's information for LATCH child restraint systems

To mount and use the LATCH child restraint systems, observe the operating and safety information from the system manufacturer; oth-

erwise, the level of protection may be reduced. ◀

Mounts for the lower LATCH anchors

The lower anchors may be used to attach the CRS to the vehicle seat up to a combined child and CRS weight of 65 lb/30 kg when the child is restrained by the internal harnesses.

Note

 Properly engage the lower LATCH anchors

Make sure that the lower LATCH anchors have properly engaged and that the child restraint system is resting snugly against the backrest; otherwise, the degree of protection may be reduced. ◀

Position



The corresponding symbol shows the mounts for the lower LATCH anchors. Seats equipped with lower anchors are marked with a pair, 2, of LATCH symbols. It is not recommended to use the inner lower anchors of standard outer



LATCH positions to fasten a child restraint system on the middle seat. Use the vehicle seat belt instead for the middle seat.

Before installing LATCH child restraint systems

Pull the belt away from the area of the child restraint system.

Assembly of LATCH child restraint systems

1. Mount the child restraint system; refer to the user's manual of the system.
2. Ensure that both LATCH anchors are properly connected.

Child restraint fixing system with a tether strap

Mounting points



The respective symbol shows the anchor for the upper retaining strap.

Seats with an upper Top Tether are marked with this symbol. It can be found on the rear seat backrest or the rear window shelf.

Note



Mounting eyelets

Use the mounting eyes only for the upper retaining strap to secure child restraint systems; otherwise, the mounting eyes could be damaged. ◀

Retaining strap guide



Retaining strap

Make sure the upper retaining strap does not run over sharp edges and is not twisted as it passes to the top anchor. Otherwise, the strap will not properly secure the child restraint system in the event of an accident. ◀

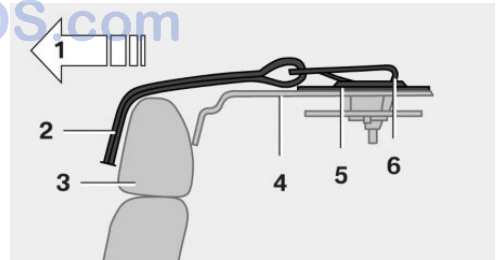

- 1 Direction of travel
- 2 Upper retaining strap
- 3 Head restraint
- 4 Rear window shelf
- 5 Mounting point/eye
- 6 Hook for upper retaining strap

Attaching the upper retaining strap to the mounting point

1. Lift the cover over the mounting point.
2. Guide the upper retaining strap over the head restraint.
3. Attach the hook of the retaining strap to the mounting eye.
4. Tighten the retaining strap by pulling it down.

امداد خودرو فارما

تلفن شبانه روزی: ۰۲۱-۸۸۸۶۲۰۸۵

FarmaSOS.com

Driving

Vehicle features and options

This chapter describes all standard, country-specific and optional features offered with the series. It also describes features that are not necessarily available in your car, e. g., due to the selected options or country versions. This also applies to safety-related functions and systems. The respectively applicable country provisions must be observed when using the respective features and systems.

Start/Stop button, drive readiness

The concept



The following ready states can be attained by pressing the Start/Stop button:

- ▷ Radio ready state on/off.
 - ▷ Operating readiness on/off.
- ▷ Activating/deactivating drive readiness.

To activate drive readiness, press the brake pedal.

Switching radio-ready state on/off

The radio-ready state is activated by pressing the Start/Stop button in the following situations:

- ▷ When the engine is running.
- ▷ When drive readiness is activated.

Some electronic systems/power consumers remain ready for operation.

The radio-ready state is switched off automatically:

- ▷ After approx. 8 minutes.
- ▷ When the vehicle is locked using the central locking system.

- ▷ Shortly before the battery is discharged completely, so that drive readiness is maintained.

The radio-ready state remains active if, e.g., the operating readiness is automatically switched off for the following reasons:

- ▷ Opening or closing the driver's door.
- ▷ Unfastening of the driver's safety belt.
- ▷ When automatically switching from low beams to parking lights.

Operating readiness on

The switched on operating readiness corresponds to the switched on ignition for conventional vehicles.

Press the Start/Stop button, and do not press on the brake pedal at the same time.

All vehicle systems are ready for operation.

Most of the indicator and warning lights in the instrument cluster light up for a varied length of time.

To save battery power when the engine is off, switch off operating readiness and any unnecessary electronic systems/power consumers.

Operating readiness is switched off automatically in the following situations:

- ▷ When locking the vehicle, even if the low beams are activated.
- ▷ Shortly before the battery is discharged completely, so that drive readiness is maintained.

Note

If the engine is switched off and operating readiness is switched on, the system automatically switches to the radio-ready state when the door is opened if the lights are turned off or, if correspondingly equipped, the daytime running lights are activated.

Operating readiness off

Press the Start/Stop button again without stepping on the brake.

All indicator lights in the instrument cluster go out.

To save battery power when the engine is off, switch off operating readiness and any unnecessary electronic systems/power consumers.

Operating readiness is switched off automatically in the following situations while the vehicle is stationary and the engine is off:

- ▷ When locking the vehicle, and when the low beams are activated.
- ▷ Shortly before the battery is discharged completely, so that drive readiness is maintained. This function is only available when the low beams are turned off.
- ▷ When opening or closing the driver door, if the driver's safety belt is unbuckled and the low beams are turned off.
- ▷ While the driver's safety belt is unbuckled with driver's door open and low beams off.

The low beams switch to parking lights after approx. 15 minutes of no use.

Selector lever position P is automatically engaged when operating readiness is switched off. In order for the vehicle to be able to roll, e.g. into a car wash, heed the information regarding washing in automatic car washes, refer to page 187.

Drive readiness

When drive readiness is activated, the vehicle is operational. Activated drive readiness is the equivalent of a running engine in conventional vehicles. Deactivated engine readiness is equivalent to switching the ignition off.

Selector lever position P is automatically engaged when drive readiness is switched off. In order for the vehicle to be able to roll, e.g. into a car wash, heed the information regarding washing in automatic car washes, refer to page 187.

Drive readiness in detail

The concept

The following are the different drive readiness variants:

- ▷ Electric drive readiness, Silent Start, refer to page 63.
The vehicle is powered by the electric motor.
- ▷ Starting the combustion engine, refer to page 63.
The vehicle is powered by the combustion engine.

Hints

 Do not leave the vehicle unattended
Do not leave the vehicle unattended with drive readiness active; otherwise, it may pose a risk. ◀

 Awareness of vehicle reduced when driven in electric mode

When driving in electric mode, note that due to the lack of engine noise pedestrians and other traffic might pay less attention to the vehicle due to missing engine noises. Please take special care when parking or leaving a parking space. ◀

Display on the Start/Stop button

General information



Drive readiness is also displayed through light indicators on the Start/Stop button.

Lighting pulses orange

- ▷ After unlocking and opening the door.
- ▷ After switching off drive readiness.

When the brake pedal is depressed, the lighting becomes more intense.

Lighting lights up steady blue

After drive readiness is switched on, light turns blue. The vehicle is ready to drive. The READY indicator lights up in the instrument cluster. In addition, a signal sounds.

Lighting off

Drive readiness, operating readiness and radio-ready state are turned off. The vehicle is in the idle state. The charging cable may be connected.

Activating drive readiness

1. Close the driver's door.
2. Depress the brake pedal.
3. Press the Start/Stop button.

Drive readiness is active, electric driving, Silent Start or Start of the combustion engine.

Electric drive readiness, Silent Start

The vehicle is ready for driving without starting the combustion engine.

Silent Start is possible if the requirements for Electric driving, refer to page 64, are met.

Display



READY indicates drive readiness.

Starting the combustion engine



Enclosed areas

Do not let the engine run in enclosed areas, since breathing in exhaust fumes may lead to loss of consciousness and death. The exhaust gases contain carbon monoxide, an odorless and colorless but highly toxic gas. ◀



Unattended vehicle

Do not leave the vehicle unattended with engine running or drive readiness switched on; otherwise, it may pose a risk.

Before leaving the vehicle, engage lever in position P P, and set the parking brake; otherwise, the vehicle is not secured against rolling away. ◀



Repeated starting in quick succession

Avoid trying to start the vehicle repeatedly and in quick succession. Otherwise, the fuel is not burned or is inadequately burned, posing a risk of overheating and damage to the catalytic converter. ◀

The combustion engine is started with Activate drive, refer to page 63, readiness under the following conditions:

- ▷ The temperature of the hybrid system is too high.
- ▷ The charge level or temperature of the high-voltage battery is too low.

Driving away

1. Activate drive readiness.
2. Apply the brake and engage lever in position P D, SPORT or R.
3. Release the parking brake.
4. Drive away.

Deactivating drive readiness

After parking the vehicle, you may hear noises due to operation of the hybrid system, such as for cooling of the high-voltage battery.

After stopping the vehicle:

1. Depress the brake pedal.
2. Set the parking brake.
3. Press the Start/Stop button.

The READY indicator goes out and a signal sounds. In case of longer idle times, follow the instructions in the Care chapter, refer to page 190.

Before driving into a car wash

So that the vehicle can roll into a car wash observe instructions for going into an automatic car wash, refer to page 187.

Electric driving: ePOWER

Note

 Awareness of vehicle reduced when driven in electric mode

When driving in electric mode, note that, due to the lack of engine noise, pedestrians and other traffic might pay less attention to the vehicle due to missing engine noises. Please take special care when parking or leaving a parking space. ◀

General information

In ePOWER, the vehicle is driven exclusively electrically. ePOWER works automatically.

Depending on the charging state of the high-voltage battery, maximum speed and range achieved can vary.

For electrical driving, certain Conditions, refer to page 64, must be satisfied.

Displays of the hybrid system, refer to page 77.

Requirements

- ▷ State of charge and temperature of the high-voltage battery is sufficient.
- ▷ Selector lever position D or R engaged.
- ▷ The accelerator pedal is only slightly depressed.
- ▷ The possible maximum speed for electric driving is not exceeded.
- ▷ The driver's door is closed.

Auto eDRIVE

General information

With each starting operation, Auto eDRIVE is activated using the Start/Stop button.

In Auto eDRIVE, the vehicle is driven in hybrid mode corresponding to the various driving situations, i.e. the drive combines combustion engine and electric motor. The respectively most effective drive type is preferred.

SAVE Battery, maintaining charging state

Should it be necessary, e.g., to conserve the electrical range for a later point in time on the trip, the current charging state of the high-voltage battery can be maintained with this function.

The function is possible under the following conditions:

- ▷ The fuel fill level is sufficient.
- ▷ Engaged selector lever position D
- ▷ Drive mode Auto eDrive

Switching on/off

1. "Settings"
2. "Auto eDRIVE"
3. "Hold state of charge"

MAX eDRIVE

General information



Max eDRIVE forces electric driving.

With Max eDRIVE, a speed of approx. 75 mph, approx. 120 km/h is possible.

In special situations, the speed limit can consciously be exceeded by applying the accelerator pedal beyond the full throttle point, kick-down. The combustion engine is automatically

activated and switched into AUTO eDRIVE mode.

Overview



Activating Max eDRIVE

eDRIVE Press button.

- ▷ LED lights up: max eDRIVE is activated.
- ▷ LED goes out: max eDRIVE is deactivated.

Acoustic pedestrian protection

Depending on the country-specific version, the system generates a continuous driving noise during electric driving up to approx. 20 mph/30 km/h.

A speaker system broadcasts the noise to the surroundings.

As a result, other traffic participants, e.g. pedestrians or cyclists, can better perceive the vehicle.

Switching on/off

Depending on the country-specific version, the system is automatically active after every driving-off or the system can be set on the Control Display.

1. "Settings"
2. "Pedestr. Protection"
3. "Activate"

Driving with the combustion engine: POWER

Depending on the operating state, the combustion engine is automatically switched on:

- ▷ Selector lever position Sport is set.
- ▷ Speed for electric driving is exceeded.
- ▷ The high-voltage battery has an insufficient charge.
- ▷ High-voltage battery is completely charged, e.g., when driving downhill.
- ▷ For improved traction, e.g., on slippery roads.
- ▷ During intense accelerations or on inclines.
- ▷ System-related requirement for hybrid components.
- ▷ Adapting to the course of the road when destination guidance is activated.

When reducing speed, the combustion engine is switched off when the conditions for electric driving, refer to page 64, are met.

Assistance for the combustion engine

Depending on the operating state, the electric motor provides assistance with additional propulsive power.

ASSIST

During normal vehicle operation, the electric motor assists the combustion engine, depending on the situation.

eBOOST

Accelerating quickly, such as when passing, requires the maximum available power from the electric motor. To do this, apply extra force to the accelerator pedal.

Energy recovery: CHARGE

The high-voltage battery is recharged in part through energy recovery. The electric motor acts as a generator when decelerating and converts the kinetic energy into electrical energy.

Energy can be recovered if the following conditions are met:

- ▷ The vehicle is moving.
- ▷ Speed higher than approx. 12 mph/20 km/h.
- ▷ Selector lever in selector lever position D, R or S.
- ▷ The high-voltage battery is not fully charged.
- ▷ Accelerator pedal is not operated.

Energy cannot be recovered in the following situations:

- ▷ Selector lever position N is set.
- ▷ While drive stability control systems control the vehicle, even though it is not indicated by an indicator light.
- ▷ The high-voltage battery is fully charged.
- ▷ When temperature of the high-voltage battery is very low or very high.

With cold external temperatures, it is possible that the energy recovery is temporarily unavailable after startup.

Parking brake

The concept

The parking brake is used to prevent the vehicle from rolling when it is parked.

Overview





 Parking brake

Setting

 Apply parking brake and further secure the vehicle if needed.

Set the parking brake firmly when parking; otherwise, the vehicle could roll. On steep upward and downward inclines, further secure the vehicle, e.g., by turning the steering wheel in the direction of the curb. ◀

 Take the remote control with you when leaving the vehicle so that children, e.g., cannot release the parking brake. ◀

 Pull the reel.
The LED lights up.

 The indicator lamp lights up red. The parking brake is set.

While driving

Use as emergency brake while driving:

Pull the reel and hold it. The vehicle brakes hard while the reel is being pulled.

 The indicator lamp lights up red, a signal sounds and the brake lights light up.

A Check Control message is displayed.

If the vehicle is slowed down to a speed of approx. 2 mph/3 km/h the parking brake is set.

Releasing

With drive readiness switched on:

 Press the reel while stepping on the brake pedal or selector lever position P is set.

The LED and indicator lamp go out.

The parking brake is released.

Automatic release

For automatic release, step on the accelerator pedal.

The LED and indicator lamp go out.

The parking brake is automatically released when you step on the accelerator:

- ▶ Drive readiness switched on.
- ▶ Drive mode engaged.
- ▶ Driver buckled in and doors closed.

 Inadvertent operation of the accelerator pedal

Make sure that the accelerator pedal is not operated unintentionally; otherwise, the vehicle is set in motion and there is a risk of an accident. ◀

Malfunction

In the event of a failure or malfunction of the parking brake, secure the vehicle against rolling using a wheel chock, e.g., when leaving it.

After a power failure

Putting the parking brake into operation

1. Switch on the ignition.

2.  Press the reel while stepping on the brake pedal or selector lever position P is set.



It may take several seconds for the brake to be put into operation. Any sounds associated with this are normal.

 The indicator lamp in the instrument cluster goes out as soon as the parking brake is ready for operation.

Turn signal, high beams, headlight flasher

Turn signal

Hints

-  Do not adjust the exterior mirrors
-  Do not adjust the exterior mirror while driving and when turn signals/hazard warning flashers are on, or else the additional turn signal lights in the exterior mirror are out of position and can't be seen. ◀

Using turn signals

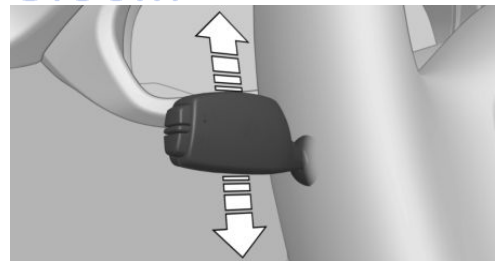

Press the lever beyond the resistance point.

To switch off manually, press the lever to the resistance point.

Unusually rapid flashing of the indicator lamp indicates that a turn signal bulb has failed.

Triple turn signal activation

Press the lever to the resistance point.

The turn signal flashes three times.

The function can be activated or deactivated.

On the Control Display:

1. "Settings"
2. "Lighting"
3. "Triple turn signal"

Settings are stored for the profile currently in use.

Signaling briefly

Press the lever to the resistance point and hold it there for as long as you want the turn signal to flash.

High beams, headlight flasher

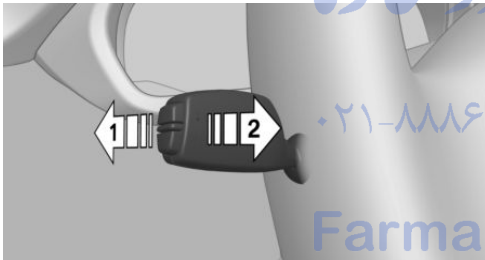

- ▷ High beams, arrow 1.
- ▷ Headlight flasher, arrow 2.

Washer/wiper system

Switching the wipers on/off and brief wipe

Hints

 Do not activate wipers if frozen to windshield

Do not switch on the wipers if they are frozen to the windshield; otherwise, the wiper blades and the wiper motor may be damaged. ◀



Do not activate wipers on dry windshield

Do not use the wipers if the windshield is dry, as this may damage the wiper blades or cause them to become worn more quickly. ◀

Switching on

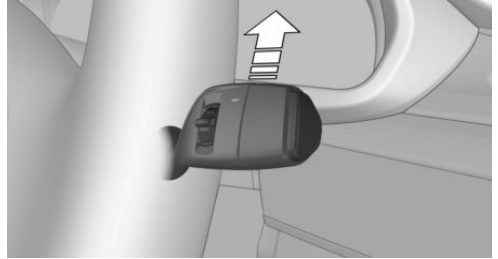

Push wiper lever up.

The lever automatically returns to its initial position when released.

- ▷ Normal wiper speed: push up once.

The wipers switch to intermittent operation when the vehicle is stationary.

- ▷ Fast wiper speed: press up twice or press once beyond the resistance point.

Wipers change to normal speed when vehicle comes to standstill.

Switch off and brief wipe

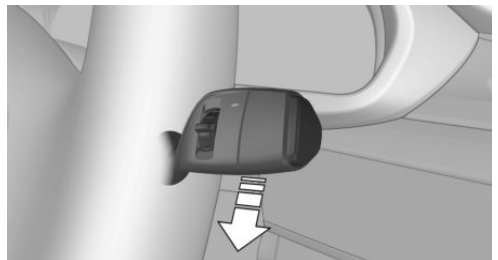

Push wiper lever down.

The lever automatically returns to its initial position when released.

- ▷ Single wipe: press down once.
- ▷ To switch off normal wipe: press down once.

- To switch off fast wipe: press down twice.

Interval mode or rain sensor

The concept

The rain sensor automatically controls the time between wipes depending on the intensity of the rainfall. The sensor is located on the windshield, directly behind the interior rearview mirror.

Activating/deactivating

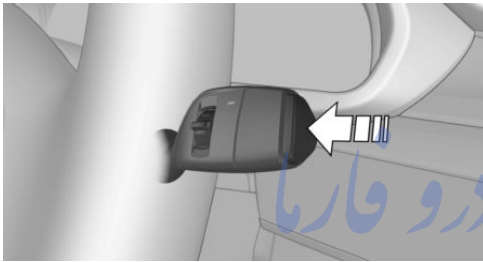

Press button on the wiper lever.

Wiping is started. If the vehicle is equipped with a rain sensor: LED in wiper lever lights up.

When wipers are frozen to windshield, wiper operation is deactivated.

-  Deactivate the rain sensor in car washes
- Deactivate the rain sensor when passing through an automatic car wash; otherwise, unintentional wiping can cause damages. ◀

Setting the frequency or sensitivity of the rain sensor

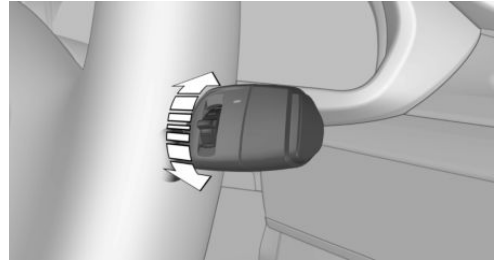

Turn the thumbwheel.

Clean the windshield

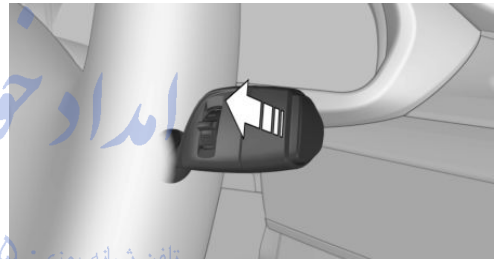

Pull the wiper lever towards you.

The system sprays washer fluid on the windshield and activates the wipers briefly.

-  Do not use the washer system at freezing temperatures

Do not use the washers if fluid could freeze onto the windshield which might impede your viewing field. Therefore use antifreeze fluid.

Avoid using the washer when the reservoir is empty; operation might damage pump. ◀

Windshield washer nozzles

The windshield washer nozzles are automatically heated while the ignition is switched on.

Fold-out position of the wipers

Fold wipers back when you want to change the blades or with pending low temperatures.

1. Switch the ignition on and off again.
2. With icy conditions make sure that blades are not frozen to the windshield.
3. Press the wiper lever up beyond the point of resistance and hold it for approx. 3 seconds, until the wiper remains in a nearly vertical position.

After the wipers are folded back down, the wiper system must be reactivated.

Folding wipers back down

Before switching the ignition on, fold the wipers back down to the windshield; otherwise, the wipers may become damaged when they are activated. ◀

1. Switch on the ignition.
2. Push wiper lever down. Wipers move to their resting position and are ready again for operation.

Washer fluid

Hints

Antifreeze for washer fluid

Antifreeze is flammable and can cause injury if it is used incorrectly.

Therefore, keep it away from possible sources of ignition.

Only keep it in the closed original container and inaccessible to children.

Follow the notes and instructions on the container.

United States: The washer fluid mixture ratio is regulated by the U.S. EPA and many individual states; do not exceed the allowable washer fluid dilution ratios limits that apply. Follow the usage instructions on the washer fluid con-

tainer. Use BMW's Windshield Washer Concentrate or the equivalent. ◀

Washer fluid reservoir

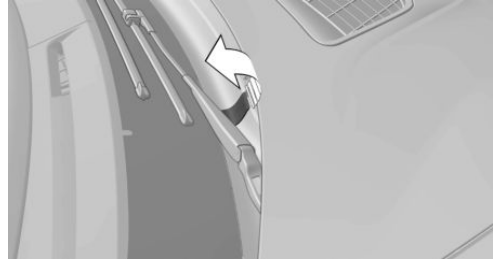

Open the cover.

All washer nozzles are supplied from one reservoir.

Fill with a mixture of windshield washer concentrate and tap water and – if required – with a washer antifreeze, according to the manufacturer's recommendations.

Mix the washer fluid before adding to find the right mixture.

Do not add windshield washer concentrate and antifreeze undiluted and do not fill with pure water; this could damage the wiper system.

Do not mix window washer concentrates of different manufacturers because they can clog the windshield washer nozzles.

Recommended minimum fill quantity:
0.2 US gal/1 liter.

Steptronic Sport transmission

Selector lever positions

D Drive

Position for normal vehicle operation. All gears for forward travel are activated automatically.

R is Reverse

Select only when the vehicle is stationary.

N Neutral:

The vehicle may roll. Use in automatic car washes, e.g.

When drive readiness is off, selector lever position P is automatically engaged.

P Park

Select only when the vehicle is stationary. The drive wheels are blocked.

P is engaged automatically:

- ▶ After drive readiness is deactivated with radio-ready state, refer to page 61, or operating readiness off, refer to page 62, when selector lever position D or R is set.
- ▶ With operating readiness off if selector lever position N is set.
- ▶ If the driver's safety belt is released, the driver's door is opened, and the brake pedal is not pressed while the vehicle is stationary and selector lever position D or R is set.

Before exiting the vehicle, make sure that selector lever position P is set. Otherwise, the vehicle may begin to move.

On uphill and downhill grades, secure the vehicle with the parking brake, refer to page 66, before shifting into selector lever position P.

Kickdown

Kickdown is used to achieve maximum driving performance. Step on the accelerator pedal beyond the resistance point at the full throttle position.

Engaging selector lever positions

- ▶ Selector lever position P can only be disengaged when the vehicle drive readiness is engaged and the brake pedal is depressed.
- ▶ With the vehicle is stationary, press on the brake pedal before shifting out of P or N;

otherwise, the shift command will not be executed: shift lock.



Press on the brake pedal until you start driving

To prevent the vehicle from creeping after you select a gear, maintain pressure on the brake pedal until you are ready to start. ◀

Engaging D, R and N



Briefly push the selector lever in the desired direction, beyond a resistance point if needed.

After releasing the selector lever, it returns to its center position.



Press unlock button, in order to:

- ▶ Engage R.
- ▶ Shift out of P.

Engaging P



Press button P.

Sport program and manual mode

Activating the sport program

By activating the Sport program, the vehicle is tuned for sporty driving.



Press the selector lever to the left out of selector lever position D.

SPORT

The SPORT indication is displayed in the instrument cluster.
The sport program of the vehicle is activated.

Activate manual mode

1. Press the selector lever to the left out of selector lever position D.
2. Push the selector lever forward or pull it backward.

Manual mode becomes active and the selector lever position is changed.

The engaged selector lever position is displayed in the instrument cluster, for instance M1.

Once maximum engine speed is attained, or if the engine is getting too hot, manual mode is automatically upshifted as needed.

Switching to manual mode

- ▷ To shift down: press the selector lever forward.
- ▷ To shift up: pull the selector lever rearwards.

The selector lever position will only be shifted at appropriate engine and road speeds and when necessary due to the temperature of the drivetrain, for example downshifting is not possible if the engine speed is too high.

The selected gear is briefly displayed in the instrument cluster, followed by the currently selected gear.

Ending the sport program/manual mode

Push the selector lever to the right.

D is displayed in the instrument cluster.

Automatic termination

Pressing the Driving Dynamics Control, refer to page 111, or the eDRIVE button, refer to page 65, terminates the Sport program of the vehicle.

The selector lever automatically tips back into the original position.

Shift paddles



The shift paddles on the steering wheel allow you to shift gears quickly while keeping both hands on the steering wheel.

The shift paddles can be used only when Driving with the combustion engine, refer to page 65.

If Auto eDrive, refer to page 64, is activated, the combustion engine starts first.

- ▶ Shift up: briefly pull right shift paddle.
- ▶ Shift down: briefly pull left shift paddle.

Gears will only be shifted at appropriate engine and road speeds, for example downshifting is not possible if the engine speed is too high.

The selected gear is briefly displayed in the instrument cluster, followed by the current gear. If the shift paddles on the steering wheel are used to shift gears in automatic mode, the transmission temporarily switches to manual mode.

In the manual mode, if there has been no acceleration or shifting of the shift paddles within a certain amount of time, the transmission switches back to automatic mode.

Displays in the instrument cluster



The selector lever position is displayed, e.g.: P.

Electronic unlocking of the transmission lock

General information

Electronically unlock the transmission lock to maneuver vehicle from the danger area.

Engaging selector lever position N

1. Depress the brake pedal.
2. Press and hold the Start/Stop button.
3. Press and hold the selector lever into position N, until position N is displayed in the instrument cluster.

A corresponding Check Control message is displayed.

4. Release Start/Stop button and selector lever.
5. Release brake.
6. Maneuver the vehicle from the danger area and secure it against moving on its own.

Launch Control

The concept

Launch Control enables optimum acceleration on surfaces with good traction.

Hints



Component wear

Do not use Launch Control too often; otherwise, this may result in premature wear of components due to the high stress placed on the vehicle. ◀

Do not use Launch Control during the break-in, refer to page 138, period.

To increase vehicle stability, activate DSC again as soon as possible.

Requirements

Launch Control is available when the combustion engine is warmed up, that is, after uninter-

rupted driving with the combustion engine of at least 6 miles/10 km.

To start with Launch Control do not steer the steering wheel.

Start with launch control

With the combustion engine running:

1.  Press button.
TRACTION is displayed in the instrument cluster and the indicator lamp for DSC OFF lights up.
2. Engage selector lever position S.
3. With the left foot, forcefully press down on the brake.
4. Press and hold down the accelerator pedal beyond the resistance point at the full throttle position.
A flag symbol is displayed in the instrument cluster.
5. The starting engine speed adjusts. Within 3 seconds, release the brake.

Before using Launch Control, allow the transmission to cool down for approx. 5 minutes.

امداد خودرو فارما
تلفن شبانه روزی: ۰۸۵-۸۸۸۶۲۰۲۱
FarmaSOS.com

Displays

Vehicle features and options

This chapter describes all standard, country-specific and optional features offered with the series. It also describes features that are not necessarily available in your car, e. g., due to the selected options or country versions. This also applies to safety-related functions and

The concept

The instrument cluster is a variable display. Some of the displays in the instrument cluster may differ from the way they are shown in this Owner's Handbook.

systems. The respectively applicable country provisions must be observed when using the respective features and systems.

Instrument cluster

If the program is changed or the Sport program activated via the Driving Dynamics Control, the display rendition adapts to the respective program.

Overview, instrument cluster



- | | | | |
|---|------------------------------|-----------------------------|---------------------------------|
| 1 | Speedometer | Selection list, e.g., radio | 86 |
| 2 | External temperature | 83 | 6 |
| 3 | Time | 83 | Performance display |
| 4 | Messages, e.g. Check Control | Navigation display | 138 |
| 5 | Driving Dynamics Control | 111 | Variable drive mode displays |
| | | | 76 |
| | | | 7 |
| | | | Trip odometer |
| | | | 83 |
| | | | 8 |
| | | | Selector lever position display |
| | | | 70 |
| | | | 9 |
| | | | READY indicator |
| | | | 63 |

10 Overall range [83](#)

11 Battery charge indicator [77](#)

12 Fuel gauge [82](#)

13 Computer [87](#)

Variable drive mode displays

ECO PRO displays

In ECO PRO, the instrument cluster switches to the ECO PRO displays. These displays support a driving style that saves on fuel consumption with more prominent representation of the efficiency display and various ECO PRO tips. ECO PRO, refer to page [145](#).

Charging screen



1 Charging status [155](#)

2 End of charging time [155](#)

Departure time with timer [156](#)

3 Maximum electrical range [155](#)

4 Stationary climate control [156](#)

5 Range for electric driving [155](#)

6 Charging state [77](#)

Displays of the hybrid system

Displays in the instrument cluster

The concept

The following functions of the hybrid system are displayed:

- ▶ High-voltage battery charge indicator, refer to page 77.
- ▶ Max eDrive, refer to page 64
- ▶ Maintaining charging state, refer to page 78.
- ▶ Electric driving: ePOWER, refer to page 77.
- ▶ Acceleration boost: eBOOST, refer to page 78.
- ▶ Energy recovery: CHARGE, refer to page 78.
- ▶ Drive readiness: READY, refer to page 77.

The display depends on the system's operating condition.

High-voltage battery charge indicator

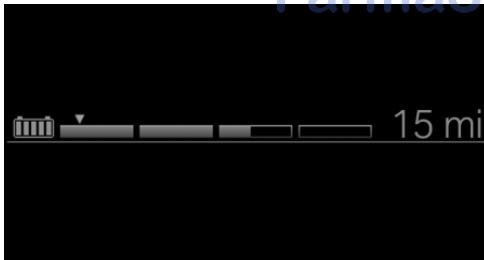

High voltage

Even if no fill level bars are displayed next to the battery symbol, the high-voltage system is still under high voltage. ◀

The fill level bars indicate the available charging state of the high-voltage battery when operating readiness and drive readiness are switched on.

In addition, the range for electric driving is displayed.

Drive readiness: READY



READY indicates drive readiness. For further information, please refer to Drive readiness in detail, refer to page 62.

Electric driving: ePOWER

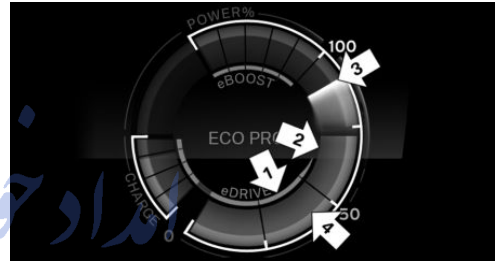

The inner narrow blue stripe, arrow 1, marks the range for electric driving.

If a white mark is located in the range after the stripe, arrow 2, the combustion engine is switched on.

In COMFORT and ECO PRO driving mode, the specified power of the electric motor and the internal combustion engine is indicated by a white mark, arrow 3.

In ECO PRO mode, the range for efficient driving style is colored blue, arrow 4.

For further information, please refer to Electric driving: eDRIVE, refer to page 64.

Energy recovery: CHARGE



The energy recovered is indicated in the COMFORT and ECO PRO modes by four bars in the CHARGE range. The high-voltage battery is being charged. Depending on the available output of the high-voltage battery, more or less eBOOST could be recovered. If the high-voltage battery is completely charged, no energy can be recovered. The four bars are grayed-out.

For further information, please refer to Energy recovery CHARGE, refer to page 66.

Acceleration boost: eBOOST



Five bars indicate the available output of the electric motor for the eBOOST, refer to page 31, acceleration boost. Depending on the available output of the high-voltage battery, there could be more or less eBOOST available. If the high-voltage battery is completely discharged, all five bars are grayed-out.

Maintaining charging state



☑ In the Maintaining charging state mode, the arrow indicates the charging state of the high-voltage battery that should be conserved for a later point in the trip.

- ▶ Gray arrow: maintaining charging state mode deactivated.
- ▶ Orange arrow: maintaining charging state mode activated.

Activating/deactivating the Maintaining charging state mode, refer to page 64.

Indications on the Control Display

Displaying the hybrid system utilization

1. "Vehicle info"
2. "eDRIVE"
3. "Consumption history"

Hybrid system utilization

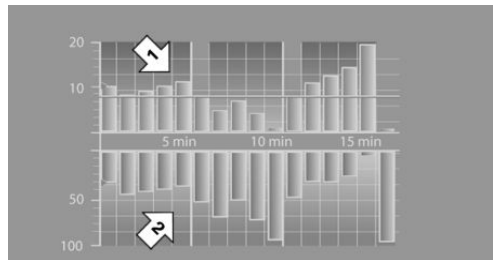

Gray bars indicate the fuel consumption of the combustion engine, arrow 1. Blue bars indicate the percentage utilization of the functions of the hybrid system, arrow 2.

One bar indicates one minute.

The combustion engine's average fuel consumption is indicated by a line above the bar display and as a value to the right of the graph.

Displaying the energy flow

1. "Vehicle info"
2. "eDRIVE"
3.  "Energy flow"

Energy flow of the hybrid system

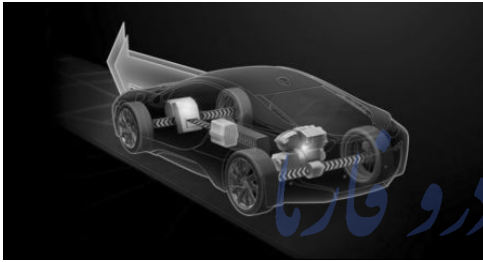

The following are displayed:

- ▶ Active components of the hybrid system.
- ▶ Direction of the energy flows:
 - Orange: energy flow of the combustion engine.
 - Blue: energy flow of the hybrid system
- ▶ Driving states:
 - ▶ ePOWER.
 - ▶ POWER.
 - ▶ eBOOST.
 - ▶ CHARGE.
 - ▶ Coasting.
 - ▶ Charging.
- ▶ System requirements of the hybrid system, e. g., drive system not yet warmed up to operating temperature.
- ▶ Driving requirement, e. g., transmission selector lever in the Sport position.

Adapting to the course of the road

When the navigation system destination guidance is active, hybrid operation adapts to specific route sections.

Use of the hybrid system is optional.

Symbols in the energy flow display indicate that a situation has been detected ahead and hybrid operation is prepared for it.

Symbols

Symbol	Meaning
	Downhill gradients: the system is ready to charge the high-voltage battery.
	Target zone: ePOWER electric driving is being prepared.



Downhill gradients: the system is ready to charge the high-voltage battery.



Target zone: ePOWER electric driving is being prepared.

Check Control

The concept

The Check Control system monitors functions in the vehicle and notifies you of malfunctions in the monitored systems.

A Check Control message is displayed as a combination of indicator or warning lights and text messages in the instrument cluster and in the Head-up Display.

In addition, an acoustic signal may sound and a text message may appear on the Control Display.

Indicator/warning lights

General information

The indicator and warning lights in the instrument cluster can light up in a variety of combinations and colors.

Several lights indicate function checks and light up only temporarily when drive readiness or operating readiness are activated.

Red lights

Airbag system



Airbag system and belt tensioner are defective.

Have the vehicle checked by the service center immediately.

Parking brake



The parking brake is set.

For additional information, refer to Release parking brake, refer to page 67.

Brake system



Continue to drive moderately.

Have the vehicle checked by the service center immediately.

BRAKE

Front-end collision warning



Illuminated: advance warning is issued, e.g., when there is the impending danger of a collision or the distance to the vehicle ahead is too small.

Increase distance.

Flashing: acute warning of the imminent danger of a collision when the vehicle approaches another vehicle at a relatively high differential speed.

Intervention by braking or make an evasive maneuver.

Pedestrian warning



If a collision with a person detected in this way is imminent, the symbol lights up and a signal sounds.

Yellow lights

Anti-lock Braking System ABS



Avoid abrupt braking if possible. Braking force boost in some cases defective. Stop carefully. Take into account longer brake travel. Have this checked by the service center immediately.



DSC Dynamic Stability Control



Flashing: DSC controls the drive and braking forces. The vehicle is stabilized. Reduce speed and adapt driving profile to the driving circumstances.

Illuminated: DSC failed. Have the system checked by the service center.

For additional information, refer to Dynamic Stability Control DSC, refer to page 109.

DSC Dynamic Stability Control is deactivated or DTC Dynamic Traction Control is activated



Dynamic Stability Control DSC is switched off or Dynamic Traction Control DTC is switched on.

For additional information, refer to Dynamic Stability Control, refer to page 109, and Dynamic Traction Control, refer to page 110.

Tire Pressure Monitor TPM



Illuminated: the Tire Pressure Monitor signals a loss of tire inflation pressure in a tire.

Reduce your speed and stop cautiously. Avoid sudden braking and steering maneuvers.

Flashing and then continuously illuminated: no flat tire or loss of tire inflation pressure can be detected.

► Interference through systems or devices with the same radio frequency: after leav-

ing the area of the interference, the system automatically becomes active again.

- ▶ TPM could not conclude the reset: perform the reset of the system again.
- ▶ A wheel without TPM electronics is fitted: have the service center check it if needed.
- ▶ Malfunction: have the system checked by your service center.

For more information, see Tire Pressure Monitor, refer to page 99.

Steering system



Steering system in some cases defective.

Have the steering system checked by the service center.

Engine functions



Have the vehicle checked by the service center.

For additional information, refer to On-board Diagnostics socket, refer to page 179.

Acoustic pedestrian protection inactive



Acoustic pedestrian protection possibly defective.

Have the system checked by the service center.

Green lights

Turn signal



Turn signal on.

Unusually rapid flashing of the indicator lamp indicates that a turn signal bulb has failed.

For additional information, refer to Turn signal, refer to page 67.

Parking lights, headlight control



Parking lights or headlights are activated.

For additional information, refer to Parking lights/low beams, headlight control, refer to page 92.

High-beam Assistant



High-beam Assistant is switched on.

High beams are activated and off automatically as a function of the traffic situation.

For additional information, refer to High-beam Assistant, refer to page 94.

Cruise control



The system is switched on. It maintains the speed that was set using the control elements on the steering wheel.

Blue lights

High beams



High beams are activated.

For additional information, refer to High beams, refer to page 68.

General lamps

Check Control



At least one Check Control message is displayed or is stored. The symbol is shown in the display of the instrument cluster.

Text messages

Text messages in combination with a symbol in the instrument cluster explain a Check Control message and the meaning of the indicator and warning lights.

Supplementary text messages

Additional information, such as on the cause of an error or the required action, can be called up via Check Control.

With urgent messages the added text will be automatically displayed on the Control Display.

Symbols

Depending on the Check Control message, the following functions can be selected.

- ▷  "Owner's Manual"

Display additional information about the Check Control message in the Integrated Owner's Manual.

- ▷  "Service request"

Contact your service center.

- ▷  "Roadside Assistance"

Contact Roadside Assistance.

Hiding Check Control messages

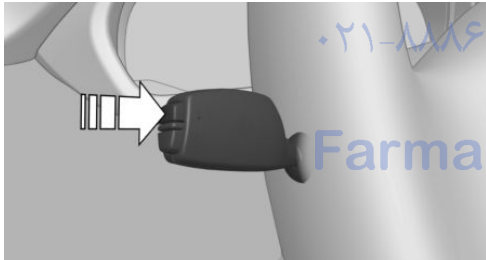

Press the onboard computer button on the turn signal lever.

- ▷ Some Check Control messages are displayed continuously and are not cleared until the malfunction is eliminated. If several malfunctions occur at once, the messages are displayed consecutively. These messages can be faded for approx. 8 seconds. After this time, they are displayed again automatically.
- ▷ Other Check Control messages are faded automatically after approx. 20 seconds.

They are stored and can be displayed again later.

Displaying stored Check Control messages

On the Control Display:

1. "Vehicle info"
2. "Vehicle status"
3.  "Check Control"
4. Select the text message.

Messages after trip completion

Special messages displayed while driving are displayed again after drive readiness is switched off.

Fuel gauge



Vehicle tilt position may cause the display to vary.

Hints on refueling, refer to page 158.

Tachometer

The tachometer is only available in the Sport program.

Always avoid engine speeds in the red warning field. In this range, the fuel supply is interrupted to protect the engine.

Engine oil temperature

If the engine oil along with the engine becomes too hot, a Check Control message is displayed.

Coolant temperature

If the coolant along with the engine becomes too hot, a Check Control message is displayed.

Check the coolant level, refer to page 177.

Odometer and trip odometer

Display

- ▷ Odometer, scope of the computer, refer to page 87.
- ▷ Trip odometer, lower right display in the instrument cluster.

Show/reset kilometers



Press the knob.

- ▷ With operating readiness turned off, the time, the external temperature and the odometer are displayed.
- ▷ When operating readiness is switched on, the trip odometer is reset.

External temperature

If the indicator drops to +37 °F/+3 °C or lower, a signal sounds.

A Check Control message is displayed.

There is an increased risk of ice on roads.



Ice on roads

Even at temperatures above +37 °F/+3 °C, roads might be icy.

Therefore, drive carefully on bridges and shaded roads, e.g., to avoid the increased risk of an accident. ◀

Time

The time is displayed in the instrument cluster.

Setting the time and time format, refer to page 89.

Date

The date is displayed in the computer.

Setting the date and date format, refer to page 89.

Range

Display



The following information about the range is displayed:

- ▷ Fill level bars of the fuel gauge, arrow 1.
- ▷ Charging state of the high-voltage battery, arrow 2.
- ▷ Range for electric driving, arrow 3.
- ▷ Total range from fuel supply and electric range, arrow 4.

Two Check Control messages indicate a limited total range.

The range display is dynamic and is influenced by several factors, such as driving style.



Refuel promptly

Refuel no later than at a range of 30 miles/50 km or engine operation might fail and damage might occur. ◀

Observe further Hints on refueling, refer to page 158.

Service requirements

The concept

The driving distance or the time to the next scheduled maintenance is displayed briefly in the instrument cluster after operating readiness is switched on.

Your service specialist can read the current service requirements from your remote control.

Display

Data regarding the service status or legally mandated vehicle inspections are automatically transmitted to your service center before a service due date.



Detailed information on service requirements

More information on the scope of service required can be displayed on the Control Display.

On the Control Display:

1. "Vehicle info"
2. "Vehicle status"
3.  "Service required"
Required maintenance procedures and legally mandated inspections are displayed.
4. Select an entry to call up detailed information.

Symbols

Symbols	Description
	No service is currently required.
	The deadline for scheduled maintenance or a legally mandated inspection is approaching.
	The service deadline has already passed.

Entering appointment dates

Enter the dates for the required inspections.

Make sure that the vehicle's date and time are set correctly.

On the Control Display:

1. "Vehicle info"
2. "Vehicle status"
3.  "Service required"
4. "§ Vehicle inspection"
5. "Date:"
6. Adjust the settings.
7. Confirm.

The entered date is stored.

Automatic Service Request

Data regarding the service status or legally mandated vehicle inspections are automatically transmitted to your service center before a service due date.

You can check when your service center was notified.

On the Control Display:

1. "Vehicle info"
2. "Vehicle status"
3. Open "Options".
4. "Last Service Request"

Gear shift indicator

The concept

The system recommends the most fuel efficient gear for the current driving situation.



Depending on the vehicle's features and country version of the vehicle, the gear shift indicator is active in the manual mode of the Steptronic transmission.

Suggestions to shift gear up or down are displayed in the instrument cluster.

The gear shift indicator is not available when Max eDRIVE is activated.

On vehicles without a gear shift indicator, the engaged gear is displayed.

Displays

Example	Description
	Fuel efficient gear is set.
	Shift into fuel efficient gear.

Speed limit detection

The concept

Speed limit detection

Speed limit detection uses a symbol in the shape of a traffic sign to display the currently detected speed limit. The camera in the area of the interior rearview mirror detects traffic signs at the edge of the road as well as variable overhead sign posts. Traffic signs with extra symbols for wet road conditions, etc. are also detected and compared with the vehicle's onboard data, such as for the rain sensor, and will be displayed depending on the situation. The system takes into account the information stored in the navigation system and also dis-

plays speed limits present on routes without signs.

Hints



Personal judgment

The system cannot serve as a substitute for the driver's personal judgment of the traffic situation.

The system assists the driver and does not replace the human eye. ◀

At a glance

Camera

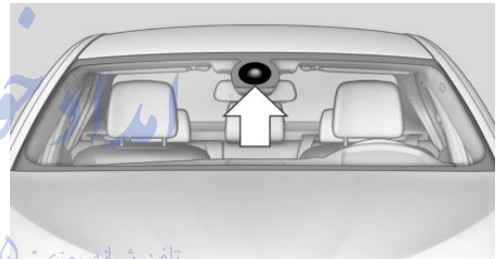

The camera is found near the interior rearview mirror.

Keep the windshield in the area behind the interior rearview mirror clean and clear.

Switching on/off

On the Control Display:

1. "Settings"
2. "Instrument cluster"
3. "Speed limit information"

If speed limit detection is switched on, it can be displayed on the info display in the instrument cluster.

Display

The following is displayed in the instrument cluster:

Speed limit detection

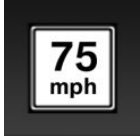

Current speed limit.



Speed limit detection is not available.

Speed limit detection can also be displayed in the Head-up Display.

System limits

The system may not be fully functional and may provide incorrect information in the following situations:

- ▷ In heavy fog, rain or snowfall.
- ▷ When signs are concealed by objects.
- ▷ When driving very close to the vehicle in front of you.
- ▷ When driving toward bright lights.
- ▷ When the windshield behind the interior rearview mirror is fogged over, dirty or covered by a sticker, etc.
- ▷ In the event of incorrect detection by the camera.
- ▷ If the speed limits stored in the navigation system are incorrect.
- ▷ In areas not covered by the navigation system.
- ▷ When roads differ from the navigation, such as due to changes in road routing.
- ▷ When passing buses or trucks with a speed sticker.
- ▷ If the traffic signs are non-conforming.
- ▷ During calibration of the camera immediately after vehicle shipment.

Selection lists in the instrument cluster

The concept

Depending on your vehicle's optional features, the following can be displayed or operated using the buttons and the thumbwheel on the steering wheel as well as the displays in the instrument cluster and the Head-up Display:

- ▷ Current audio source.
- ▷ Redial phone feature.
- ▷ Turn on voice activation system.

It also displays programs of the Driving Dynamics Control.

Display

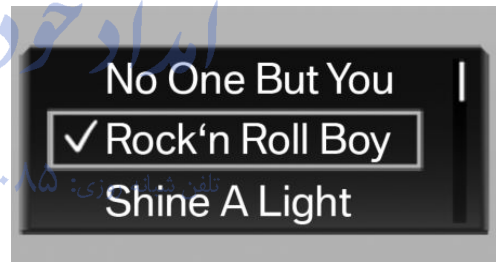

Depending on your vehicle's optional features, the list in the instrument cluster can differ from the illustration shown.

Activating a list and adjusting the setting

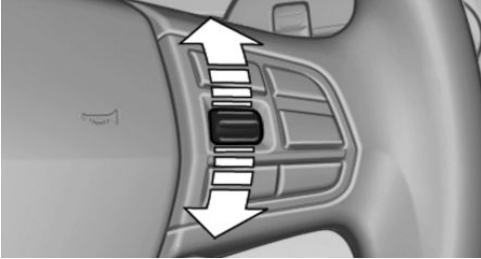

On the right side of the steering wheel, turn the thumbwheel to activate the corresponding list.

Using the thumbwheel, select the desired setting and confirm it by pushing the thumbwheel.

On-board computer

Display in the instrument cluster

The information from the computer is shown in the lower left area of the instrument cluster.

Calling up information on the info display

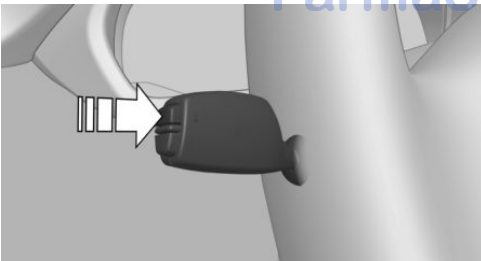

Press the onboard computer button on the turn signal lever.

Information is displayed in the info display of the instrument cluster.

Information at a glance

Repeatedly pressing the button on the turn signal lever calls up the following information in the info display:

- ▷ Kilometers.
- ▷ Average consumption, fuel.
- ▷ Average consumption, electric.
- ▷ Current consumption, electric.
- ▷ Average speed.
- ▷ Date.
- ▷ Time of arrival.
- ▷ Distance to destination.

Adjusting displays for computer

You can select what information from the computer is to be displayed in the instrument cluster.

On the Control Display:

1. "Settings"
2. "Instrument cluster"
3. Select the desired displays.

Information in detail

Total range

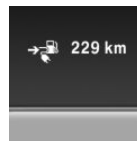

The total range considers the capacity of the fuel tank as well as the electric energy in the high-voltage battery.

Average fuel consumption

The average fuel consumption is calculated on the basis of various distances. Standstill with drive readiness turned off is not considered.

Current fuel consumption

Displays the current energy consumption. The efficiency of the driving can be monitored.

Average speed

Periods when vehicle is parked with drive readiness switched off are not included when calculating average speed.

Resetting average values

Press and hold the onboard computer button on the turn signal lever.

Time of arrival

The estimated time of arrival is displayed if a destination is entered in the navigation system before the trip is started.

The time must be correctly set.

Distance to destination

The distance remaining to the destination is displayed if a destination is entered in the navigation system before the trip is started.

The distance to the destination is adopted automatically.

Speed limit detection

Description of the speed limit detection, refer to page 85, function.

Trip computer

The vehicle features two types of board computers.

- ▷ "Onboard info": the values can be reset as often as necessary.
- ▷ "Trip computer": the values provide an overview of the current trip.

Resetting the trip computer

On the Control Display:

1. "Vehicle info"
2. "Trip computer"
3. "Reset": all values are reset.
"Automatically reset": all values are reset approx. 4 hours after the vehicle came to a standstill.

Display on the Control Display

Display the computer or trip computer on the Control Display.

1. "Vehicle info"
2. "Onboard info" or "Trip computer"

Resetting the fuel consumption or speed

On the Control Display:

1. "Vehicle info"
2. "Onboard info"
3. "Consumpt." or "Speed"
4. "Yes"

Speed warning

The concept

Displays a speed, when reached, should cause a warning to be issued.

The warning is repeated if the vehicle speed drops below the set speed once by at least 3 mph/5 km/h.

Displaying, setting or changing the speed warning

On the Control Display:

1. "Settings"
2. "Speed"
3. "Warning at:"
4. Turn the controller until the desired speed is displayed.
5. Press the controller.
Speed warning is stored.

Activating/deactivating the speed warning

On the Control Display:

1. "Settings"
2. "Speed"
3. "Warning"
4. Press the controller.

Setting your current speed as the speed warning

On the Control Display:

1. "Settings"
2. "Speed"
3. "Select current speed"
4. Press the controller.

The current vehicle speed is stored as the speed warning.

Settings on the Control Display

Time

Setting the time zone

1. "Settings"
2. "Time/Date"
3. "Time zone:"
4. Select the desired time zone.

The time zone is stored.

Setting the time

1. "Settings"
2. "Time/Date"
3. "Time:"
4. Turn the controller until the desired hours are displayed.
5. Press the controller.

6. Turn the controller until the desired minutes are displayed.
7. Press the controller.

The time is stored.

Setting the time format

1. "Settings"
2. "Time/Date"
3. "Format:"
4. Select the desired format.

The time format is stored.

Automatic time setting

Depending on your vehicle's optional features, the time, date and, if needed, the time zone are updated automatically.

1. "Settings"
2. "Time/Date"
3. "Auto time set"

Date

Setting the date

1. "Settings"
2. "Time/Date"
3. "Date:"
4. Turn the controller until the desired day is displayed.
5. Press the controller.
6. Make the necessary settings for the month and year.

The date is stored.

Setting the date format

1. "Settings"
2. "Time/Date"
3. "Format:"
4. Select the desired format.

The date format is stored.

Language

Setting the language

To set the language on the Control Display:

1. "Settings"
2. "Language/Units"
3. "Language:"
4. Select the desired language.

Settings are stored for the profile currently in use.

Setting the voice dialog

Voice dialog for the voice activation system, refer to page 27.

Units of measure

Setting the units of measure

To set the units for fuel consumption, route/distance and temperature:

1. "Settings"
2. "Language/Units"
3. Select the desired menu item.
4. Select the desired unit.

Settings are stored for the profile currently in use.

Brightness

Setting the brightness

To set the brightness of the Control Display:

1. "Settings"
2. "Control display"
3. "Brightness"
4. Turn the controller until the desired brightness is set.
5. Press the controller.

Settings are stored for the profile currently in use.

Depending on the light conditions, the brightness settings may not be clearly visible.

Activating/deactivating display of the current vehicle position

If GPS geolocation has been activated, the current vehicle position can be displayed in the BMW i Remote App or in the ConnectedDrive customer portal.

1. "Settings"
2. "GPS tracking"
3. "GPS tracking"

Head-up Display

The concept

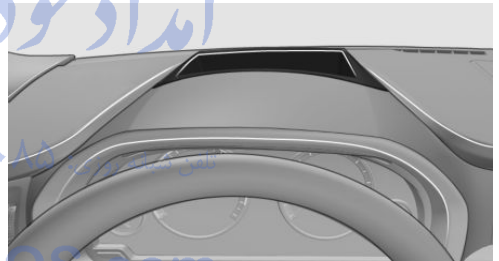

This system projects important information into the driver's field of vision, e.g., the speed.

The driver can get information without averting his or her eyes from the road.

Display visibility

The visibility of the displays in the Head-up Display is influenced by the following factors:

- ▷ Certain sitting positions.
- ▷ Objects on the cover of the Head-up Display.
- ▷ Sunglasses with certain polarization filters.
- ▷ Wet roads.
- ▷ Unfavorable light conditions.

If the image is distorted, check the basic settings.

Switching on/off

1. "Settings"
2. "Head-Up Display"
3. "Head-Up Display"

Display

Overview

- ▷ Speed.
- ▷ Navigation system.
- ▷ Check Control messages.
- ▷ Selection list from the instrument cluster.
- ▷ Driver assistance systems.

Some of this information is only displayed briefly as needed.

Selecting displays in the Head-up Display

On the Control Display:

1. "Settings"
2. "Head-Up Display"
3. "Displayed information"
4. Select the desired displays in the Head-up Display.

Settings are stored for the profile currently in use.

Setting the brightness

The brightness is automatically adjusted to the ambient brightness.

The basic setting can be adjusted manually.

On the Control Display:

1. "Settings"
2. "Head-Up Display"
3. "Brightness"
4. Turn the controller.

When the low beams are activated, the brightness of the Head-up Display can be additionally influenced using the instrument lighting.

Settings are stored for the profile currently in use.

Adjusting the height

On the Control Display:

1. "Settings"
2. "Head-Up Display"
3. "Height"
4. Turn the controller.

Settings are stored for the profile currently in use.

Setting the rotation

On the Control Display:

1. "Settings"
2. "Head-Up Display"
3. "Rotation"
4. Turn the controller.

Settings are stored for the profile currently in use.

Special windshield

The windshield is part of the system.

The shape of the windshield makes it possible to display a precise image.

A film in the windshield prevents double images from being displayed.

Therefore, have the special windshield replaced by a service center only.

Lights

Vehicle features and options

This chapter describes all standard, country-specific and optional features offered with the series. It also describes features that are not necessarily available in your car, e. g., due to the selected options or country versions. This also applies to safety-related functions and systems. The respectively applicable country provisions must be observed when using the respective features and systems.

Overview

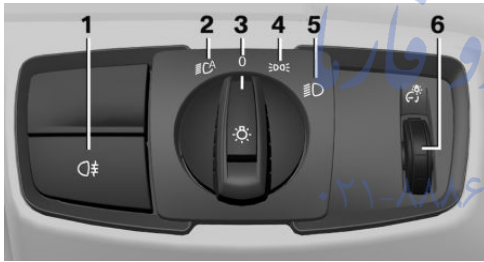

- 1 Rear fog lights
- 2 Depending on the equipment: automatic headlamp control, High-beam Assistant, welcome lamps, daytime running lights
- 3 Lights off, daytime running lights
- 4 Parking lights / daytime running lights
- 5 Low beams/welcome lights
- 6 Instrument lighting



Parking lights/low beams, headlight control

General information

Position of switch: 0, , 

With driver's door open and operating readiness turned off, the exterior lighting will be turned off automatically.

Parking lights

Position of switch   : the vehicle's lights light up on all sides, e.g., for parking.



Do not use the parking lights for extended periods; otherwise, they might drain the battery and it would then be impossible to start the engine.

When parking, it is preferable to switch on the one-sided roadside parking lights, refer to page 93.

Low beams

Position of switch  with operating readiness switched on: the low beams light up.

Welcome lights

When the vehicle is parked, leave the switch in position  or  : parking and interior lights come on briefly when the vehicle is unlocked depending on the ambient brightness.

Activating/deactivating

On the Control Display:

1. "Settings"
2. "Lighting"
3. "Welcome lights"

Settings are stored for the profile currently in use.

Headlight courtesy delay feature

The low beams stay lit for a short while if the headlight flasher is switched on after the radio-ready state is switched off.

Setting the duration

On the Control Display:

1. "Settings"
2. "Lighting"
3. "Pathway lighting:"
4. Set length of time.

Settings are stored for the profile currently in use.

Automatic headlight control

Position of switch  : the low beams are activated and off automatically, e.g., in tunnels, in twilight or if there is precipitation. The indicator lamp in the instrument cluster lights up.

When emerging from a tunnel during the day, the low beams are not switched off immediately but instead only after approx. 2 minutes.

A blue sky with the sun low on the horizon can cause the lights to be switched on.







Personal responsibility

The automatic headlight control cannot serve as a substitute for your personal judgment in determining when to turn the lights on in response to ambient lighting conditions.

E. g. the sensors are unable to detect fog or hazy weather. To avoid safety risks under these conditions, you should always switch on the lights manually. ◀

Daytime running lights

With the ignition switched on, the daytime running lights light up in position  ,  or  . After operating readiness is switched off, the parking lights light up in position  .

Activating/deactivating

In some countries, daytime running lights are mandatory, so it may not be possible to deactivate the daytime running lights.

On the Control Display:

1. "Settings"

2. "Lighting"

3. "Daytime running lamps"

Settings are stored for the profile currently in use.

Roadside parking lights

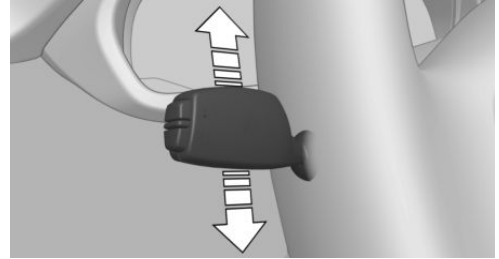

The vehicle can be illuminated on one side.

Switching on

With operating readiness switched off, press the lever either up or down past the resistance point for approx. 2 seconds.

Switch off

Briefly press the lever to the resistance point in the opposite direction.

Variable light distribution

The concept

This variable light distribution ensures that the roadway is still more effectively illuminated, depending on the vehicle speed.

The light distribution is automatically adjusted to the speed. The freeway lights are activated at speeds above 110 km/h after approx. 30 seconds or at a speed of 140 km/h.

Activating

Position of switch  with the ignition switched on.

Malfunction

A Check Control message is displayed.

Variable light distribution is disrupted or failed. Have the system checked as soon as possible.

High-beam Assistant

The concept

When the low beams are activated, this system automatically switches the high beams on and off. The procedure is controlled by a camera on the front of the interior rearview mirror. The assistant ensures that the high beams are activated whenever the traffic situation allows. The driver can intervene at any time and switch the high beams non and off as usual.



Note

 Personal responsibility

The High-beam Assistant cannot serve as a substitute for the driver's personal judgment of when to use the high beams. Therefore, manually reel off the high beams in situations where required to avoid a safety risk. ◀

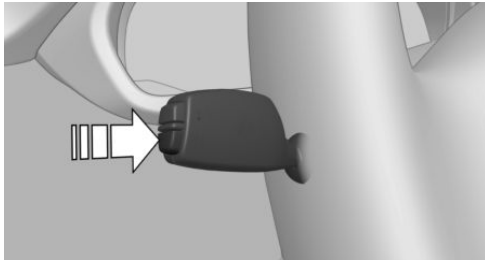
Activating



1. Depending on the equipment, turn the light switch into position  or  .
2. Press button on the turn signal lever, arrow.

 The indicator lamp in the instrument cluster lights up.

When the low beams are on, the lights are automatically brightened or dimmed.

The system responds to light from oncoming traffic and traffic driving ahead of you, and to adequate illumination, e.g., in towns and cities.



The blue indicator lamp in the instrument cluster lights up when the system switches on the high beams.

Switching the high beams on and off manually

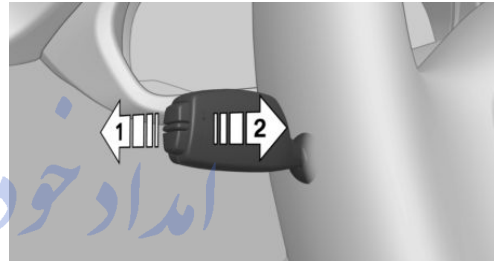

- ▷ High beams on, arrow 1.
- ▷ High beams off/headlight flasher, arrow 2.

The High-beam Assistant can be switched off when manually adjusting the light. To reactivate the High-beam Assistant, press the button on the turn signal lever.

System limits

The system is not fully functional in situations such as the following, and driver intervention may be necessary:

- ▷ In very unfavorable weather conditions, such as fog or heavy precipitation.
- ▷ When detecting poorly-lit road users such as pedestrians, cyclists, horseback riders and wagons; when driving close to train or ship traffic; and at animal crossings.
- ▷ In tight curves, on hilltops or in depressions, in cross traffic or half-observed oncoming traffic on freeways.
- ▷ In poorly-lit towns and cities and in the presence of highly reflective signs.

- At low speeds.
- When the windshield behind the interior rearview mirror is fogged over, dirty or covered with stickers, etc.

Instrument lighting

Adjusting



The parking lights or low beams must be switched on to adjust the brightness.

Adjust the brightness with the thumbwheel.

Interior lights

General information

The interior lights, footwell lights, access lights and courtesy lights are controlled automatically.

Thumb wheel for the instrument lighting controls brightness of some of these features.

Overview



- 1 Interior lights
- 2 Reading lamp

Switching the interior lights on and off



Press button.

To reel off permanently: press the button for approx. 3 seconds.

Switch back on: press button.

Reading lights



Press button.

Reading lights are located in the front next to the interior light.

Ambient light

Depending on your optional features lighting can be adjusted for some lights in the interior.

Selecting color scheme

On the Control Display:

1. "Settings"
2. "Lighting"
3. "Lighting design"
4. Select desired setting.

To deactivate the ambient light: "Off".

Setting the brightness

On the Control Display:

1. "Settings"
2. "Lighting"
3. "Brightness:"
4. Adjust the brightness.

Safety

Vehicle features and options

This chapter describes all standard, country-specific and optional features offered with the series. It also describes features that are not necessarily available in your car, e. g., due to

the selected options or country versions. This also applies to safety-related functions and systems. The respectively applicable country provisions must be observed when using the respective features and systems.

Airbags

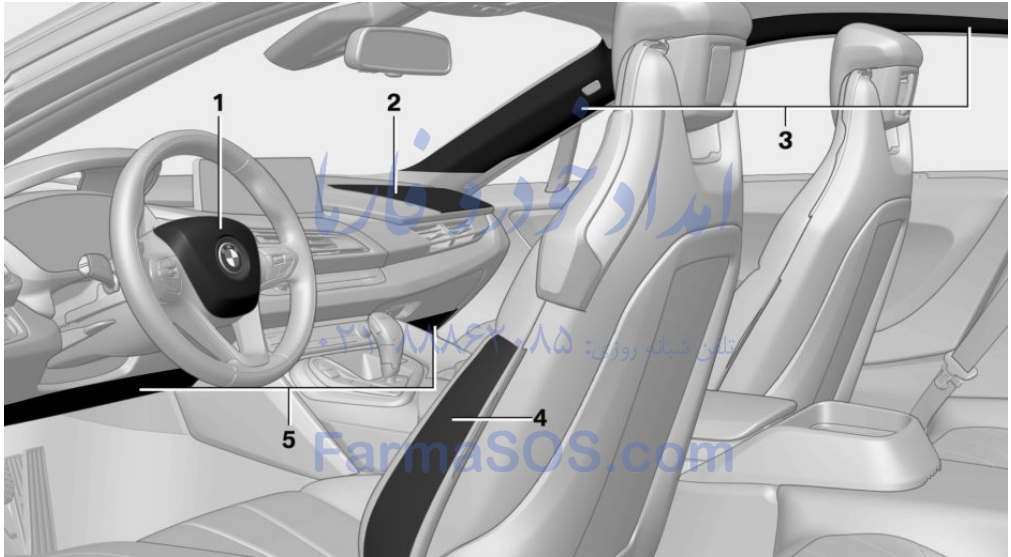

- 1 Front airbag, driver
- 2 Front airbag, front passenger
- 3 Head airbag
- 4 Side airbag
- 5 Knee airbags

Front airbags

Front airbags help protect the driver and front passenger by responding to frontal impacts in which safety belts alone would not provide adequate restraint.

Side airbags

In a lateral impact, the side airbag supports the side of the body in the chest and lap area.

Head airbags

In a lateral impact, the head airbag supports the head.

Knee airbag

The knee airbag supports the legs in a frontal impact.

Protective action

Airbags are not triggered in every impact situation, e.g., in less severe accidents or rear-end collisions.

 Information on how to ensure the optimal protective effect of the airbags

- ▷ Keep at a distance from the airbags.
- ▷ Always grasp the steering wheel on the steering wheel rim, holding your hands at the 3 o'clock and 9 o'clock positions, to keep the risk of injury to your hands or arms as low as possible when the airbag is triggered.
- ▷ There should be no person, animals, or objects between an airbag and a person.
- ▷ Do not use the cover of the front airbag on the front passenger side as a storage area.
- ▷ Dashboard and windshield on the front passenger side must stay clear - do not attach adhesive labels or coverings and do not attach brackets or cables, e. g., for GPS devices or mobile phones.
- ▷ Make sure that the front passenger is sitting correctly, i.e., keeps his or her feet and legs in the footwell; otherwise, leg injuries might occur when front airbag is activated.
- ▷ Do not place slip covers, seat cushions or other objects on the front passenger seat that are not approved specifically for seats with integrated side airbags.
- ▷ Do not hang pieces of clothing, such as jackets, over the backrests.
- ▷ Make sure that occupants keep their heads away from the side airbag and do not rest against the head airbag; otherwise, injuries might occur when airbag is activated.
- ▷ Do not remove the airbag system.
- ▷ Do not remove the steering wheel.

- ▷ Do not apply adhesive materials to the airbag cover panels, do not cover them or modify them in any way.
- ▷ Never modify either the individual components or the wiring in the airbag system. This also applies to steering wheel covers, the dashboard, the seats, the roof pillars and the sides of the roofliner. ◀

Even when you follow all instructions very closely, injury from contact with the airbags cannot be ruled out in certain situations.

The ignition and inflation noise may lead to short-term and, in most cases, temporary hearing impairment in sensitive individuals.

 Malfunction, deactivation and after deploying the airbags

Do not touch the individual components immediately after the system has been triggered; otherwise, you may risk burns.

Only have the airbags checked, repaired or dismantled and the airbag generator scrapped by the service center or an authorized repair shop for handling explosives.

Non-professional attempts to service the system could lead to failure in an emergency or unintentional activation of the airbag - both may lead to injury. ◀

Warnings and information on the airbags are also found on the sun visors.

Functional readiness of the airbag system

 With operating readiness turned on warning light in the instrument cluster lights up briefly indicating airbag system and belt tension are functional.

Airbag system malfunctioning

- ▷ Warning lamp does not come on when operating readiness is turned on.
- ▷ The warning lamp lights up continuously.

 In case of a malfunction have airbag system checked immediately.

In case of a malfunction have airbag system checked immediately; otherwise, there is a risk that the system does not function as expected in case of a severe accident. ◀

Automatic deactivation of the front-seat passenger airbags

The system reads if the front passenger seat is occupied by measuring the human body's resistance.

Front, knee and side airbag on the front passenger's side are either activated or deactivated.

 Leave feet in the footwell

Make sure that the front passenger keeps his or her feet in the footwell; otherwise, proper functioning of the front passenger airbag might not be assured. ◀

 Child restraint fixing system in the front passenger seat

Before transporting a child on the front passenger seat, refer to the safety notes and instructions for children on the front passenger seat, see Children. ◀

Malfunction of the automatic deactivation system

When transporting older children and adults, the front-seat passenger airbags may be deactivated in certain sitting positions. In this case, the indicator lamp for the front-seat passenger airbags lights up.

In this case, change the sitting position so that the front-seat passenger airbags are activated and the indicator lamp goes out.

If it is not possible to activate the airbags, have the person sit in the rear.

To enable correct recognition of the occupied seat cushion

- ▶ Do not attach covers, cushions, ball mats or other items to the front passenger seat unless they are specifically recommended by your vehicle's manufacturer.
- ▶ Do not place any electronic devices on the passenger seat if a child restraint system is to be installed on it.
- ▶ Do not place objects under the seat that could press against the seat from below.
- ▶ No moisture in or on the seat.

Indicator lamp for the front-seat passenger airbags



The indicator lamp for the front-seat passenger airbags indicates the operating state of the front-seat passenger airbags.

The lamp indicates whether the airbags are either activated or deactivated.



- ▶ The indicator lamp lights up when a child is properly seated in a child restraint fixing system or when the seat is empty. The airbags on the front passenger side are not activated.
- ▶ The indicator lamp does not light up when, e.g., a correctly seated person of sufficient size is detected on the seat. The airbags on the front passenger side are activated.

Detected child seats

The system generally detects children seated in a child seat, particularly in child seats required by NHTSA when the vehicle was manu-

factured. After installing a child seat, make sure that the indicator lamp for the front-seat passenger airbags lights up. This indicates that the child seat has been detected and the front-seat passenger airbags are not activated.

Strength of the driver's and front-seat passenger airbag

The explosive power that activates driver's/ front passenger's airbags very much depends on the positions of the driver's/front passenger's seat.

With a respective message appearing on Control Display calibrate the front seats to keep the accuracy of this function over the long-term.

Calibrating the front seats

A corresponding message appears on the Control Display.

1. Press the reel and move the respective seat all the way forward.
2. Press the reel forward again. The seat still moves forward slightly.
3. Readjust the seat to the desired position.

The calibration procedure is completed when the message on the Control Display disappears.

If the message continues to be displayed, repeat the calibration.

If the message does not disappear after a repeat calibration, have the system checked as soon as possible.



Unobstructed area of movement

Ensure that the area of movement of the seats is unobstructed to avoid personal injury or damage to objects. ◀

Tire Pressure Monitor TPM

The concept

The system monitors tire inflation pressure in the four mounted tires. The system warns you if there is a significant loss of pressure in one or more tires. For this purpose, sensors in the tire valves measure the tire inflation pressure and tire temperature.

Hints



Tire damage due to external factors

Sudden tire damage caused by external circumstances cannot be recognized in advance. ◀

With use of the system observe further information found under Tire inflation pressure, refer to page 163.

Functional requirements

The system must have been reset with the correct tire inflation pressure; otherwise, reliable signaling of tire inflation pressure loss is not assured.

Reset the system after each adjustment of the tire inflation pressure and after every tire or wheel change.

Always use wheels with TPM electronics to ensure that the system will operate properly.

Status display

The current status of the Tire Pressure Monitor TPM can be displayed on the Control Display, e.g., whether or not the TPM is active.

On the Control Display:

1. "Vehicle info"
2. "Vehicle status"
3. (!) "Tire Pressure Monitor (TPM)"

The status is displayed.

Status control display

Tire and system status are indicated by the color of the wheels and a text message on the Control Display.

All wheels green

System is active and will issue a warning relative to the tire inflation pressures stored during the last reset.

One wheel is yellow

A flat tire or major drop in inflation pressure in the indicated tire.

All wheels are yellow

A flat tire or major drop in inflation pressure in several tires.

Wheels, gray

The system cannot detect a flat tire. Reasons for this may be:

- ▷ The system is being reset.
- ▷ Malfunction.

Status information

The status control display additionally shows the current tire inflation pressures and, depending on the model, tire temperatures. It shows the actual values read; they may vary depending on driving style or weather conditions.

Carry out reset

Reset the system after each adjustment of the tire inflation pressure and after every tire or wheel change.

On the Control Display and on the vehicle:

1. "Vehicle info"
2. "Vehicle status"
3.  "Perform reset"
4. Switch on drive readiness – do not drive off.

5. Reset tire inflation pressure: "Perform reset".
6. Drive away.

The tires are shown in gray and the status is displayed.

After driving faster than 19 mph/30 km/h for a short period, the set tire inflation pressures are accepted as reference values. The reset is completed automatically while driving.

The progress of the reset is displayed.

After a successfully completed Reset, the wheels on the Control Display are shown in green and "Tire Pressure Monitor (TPM) active" is displayed.

You may interrupt this trip at any time. When you continue the reset resumes automatically.

Low tire pressure message



The yellow warning lamp lights up. A Check Control message is displayed.

- ▷ There is a flat tire or a major loss in tire inflation pressure.
- ▷ No reset was performed for the system. The system therefore issues a warning based on the tire inflation pressures before the last reset.

Reduce your speed and stop cautiously. Avoid sudden braking and steering maneuvers. Do not continue driving, and contact the service center.

If a Mobility System is not available, contact the service center.

A low tire inflation pressure might turn on DSC Dynamic Stability Control.

Required tire inflation pressure check message

A Check Control message is displayed in the following situations

- ▷ The system has detected a wheel change, but no reset was done.

- Inflation was not carried out according to specifications.
- The tire inflation pressure has fallen below the level of the last confirmation.

In this case:

- Check the tire pressure and correct as needed.
- Carry out a reset of the system after a tire change.

System limits

The system does not function properly if a reset has not been carried out, e.g., a flat tire is reported though tire inflation pressures are correct.

The tire inflation pressure depends on the tire's temperature. Driving or exposure to the sun will increase the tire's temperature, thus increasing the tire inflation pressure. The tire inflation pressure is reduced when the tire temperature falls again. These circumstances may cause a warning when temperatures fall very sharply.

Malfunction



The yellow warning lamp flashes and then lights up continuously. A Check Control message is displayed. No flat tire or loss of tire inflation pressure can be detected.

Display in the following situations:

- A wheel without TPM electronics is fitted: have the service center check it if needed.
- Malfunction: have the system checked by your service center.
- TPM was unable to complete the reset. Reset the system again.
- Interference through systems or devices with the same radio frequency: after leaving the area of the interference, the system automatically becomes active again.

Declaration according to NHTSA/ FMVSS 138 Tire Pressure Monitoring System

Each tire, including the spare (if provided) should be checked monthly when cold and inflated to the inflation pressure recommended by the vehicle manufacturer on the vehicle placard or tire inflation pressure label. (If your vehicle has tires of a different size than the size indicated on the vehicle placard or tire inflation pressure label, you should determine the proper tire inflation pressure for those tires.) As an added safety feature, your vehicle has been equipped with a tire pressure monitoring system (TPMS) that illuminates a low tire pressure telltale when one or more of your tires is significantly under-inflated. Accordingly, when the low tire pressure telltale illuminates, you should stop and check your tires as soon as possible, and inflate them to the proper pressure. Driving on a significantly under-inflated tire causes the tire to overheat and can lead to tire failure. Under-inflation also reduces fuel efficiency and tire tread life, and may affect the vehicle's handling and stopping ability. Please note that the TPMS is not a substitute for proper tire maintenance, and it is the driver's responsibility to maintain correct tire pressure, even if under-inflation has not reached the level to trigger illumination of the TPMS low tire pressure telltale. Your vehicle has also been equipped with a TPMS malfunction indicator to indicate when the system is not operating properly. The TPMS malfunction indicator is combined with the low tire pressure telltale. When the system detects a malfunction, the telltale will flash for approximately one minute and then remain continuously illuminated. This sequence will continue upon subsequent vehicle start-ups as long as the malfunction exists. When the malfunction indicator is illuminated, the system may not be able to detect or signal low tire pressure as intended. TPMS malfunctions may occur for a variety of reasons, including the installation of replacement or alternate tires or wheels on the vehicle

that prevent the TPMS from functioning properly. Always check the TPMS malfunction tell-tale after replacing one or more tires or wheels on your vehicle to ensure that the replacement or alternate tires and wheels allow the TPMS to continue to function properly.

Intelligent Safety

The concept

Intelligent Safety enables central operation of the driver assistance system.

The intelligent safety systems can help prevent an imminent collision.

- ▶ Front-end collision warning with City Braking function, refer to page 103.
- ▶ Pedestrian warning with City Braking function, refer to page 105.

Hints

Personal responsibility

The system does not serve as a substitute for the driver's personal judgment of the traffic situation.

Be aware of the traffic situation and the vehicle's surroundings at all times, otherwise accidents are still possible despite all warnings. ◀

Adapting your speed and driving style

The displays and warnings of the system do not relieve the driver of the responsibility to adapt his or her driving speed and style to the traffic conditions. ◀

Be alert

Due to system limitations, warnings may be not issued at all, or may be issued late or improperly. Therefore, always be alert and ready to intervene; otherwise, there is the risk of an accident. ◀

At a glance

Button in the vehicle



 Intelligent Safety button

Switching on/off

Some Intelligent Safety systems are automatically active after every departure. Some Intelligent Safety systems activate according to the last setting.

Press button briefly:

- ▶ The menu for the intelligent safety system is displayed. The systems are individually switched off according to their respective settings.
- ▶ LED lights up orange or goes out respective to their individual settings.

Adjust as needed. Individual settings are stored for the profile currently in use.

Press button again:

- ▶ All Intelligent Safety systems are activated.
- ▶ The LED lights up green.

Hold down button:

- ▶ All Intelligent Safety systems are turned off.
- ▶ The LED goes out.

Front-end collision warning with City Braking function

The concept

The system can help prevent accidents. If an accident cannot be prevented, the system will help reduce the collision speed.

The system sounds a warning before an imminent collision and actuates brakes independently if needed.

The automatic braking intervention is done with limited force and duration.

A camera in the area of the rearview mirror controls the system.

The front-end collision warning is available even if cruise control has been deactivated.

With the vehicle approaching another vehicle intentionally the collision warning is delayed avoiding false alarm.

General information

The system warns at two levels of an imminent danger of collision at speeds from approx.

3 mph/5 km/h. Time of warnings may vary with the current driving situation.

Appropriate braking kicks in at speeds of up to 35 mph/60 km/h.

Detection range

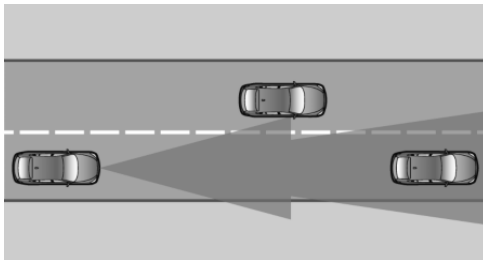

It responds to objects if they are detected by the system.

Hints



Personal responsibility

The system does not serve as a substitute for the driver's personal judgment of the traffic situation.

Be aware of the traffic situation and the vehicle's surroundings at all times, otherwise accidents are still possible despite all warnings. ◀



Adapting your speed and driving style

The displays and warnings of the system do not relieve the driver of the responsibility to adapt his or her driving speed and style to the traffic conditions. ◀



Be alert

Due to system limitations, warnings may be not issued at all, or may be issued late or improperly. Therefore, always be alert and ready to intervene; otherwise, there is the risk of an accident. ◀

At a glance

Button in the vehicle



Intelligent Safety button

Camera

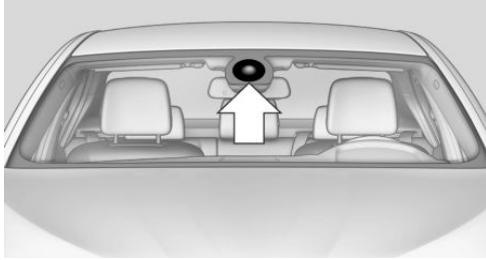

The camera is found near the interior rearview mirror.

Keep the windshield in the area behind the interior rearview mirror clean and clear.

Switching on/off

Switching on automatically

The system is automatically active after every driving-off.

Switching on/off manually



Press button briefly:

- ▶ The menu for the intelligent safety system is displayed. The systems are individually switched off according to their respective settings.

- ▶ LED lights up orange or goes out respective to their individual settings.

Adjust as needed. Individual settings are stored for the profile currently in use.



Press button again:

- ▶ All Intelligent Safety systems are activated.

- ▶ The LED lights up green.



Hold down button:

- ▶ All Intelligent Safety systems are turned off.

- ▶ The LED goes out.

Setting the warning time

The warning time can be set via iDrive.



1. "Settings"
2. "Frontal Coll. Warning"
3. Activate the desired time on the Control Display.

The selected time is stored for the profile currently in use.

Warning with braking function

Display

If a collision with a recognized vehicle is imminent a warning symbol appears in the instrument cluster and in the Head-Up Display.

Symbol	Measure
	The vehicle lights up red: prewarning. Brake and increase distance.
	The vehicle flashes red and an acoustic signal sounds: acute warning. You are requested to intervene by braking or make an evasive maneuver.



Prewarning

This warning is issued, e.g., when there is the impending danger of a collision or the distance to the vehicle ahead is too small.

The driver must intervene actively when there is a prewarning.

Acute warning with braking function

Warning of the imminent danger of a collision when the vehicle approaches another object at a relatively high differential speed.

The driver must intervene actively when there is an acute warning. If necessary, the driver is assisted by a minor automatic braking intervention in a possible risk of collision.

Acute warnings can also be triggered without previous prewarning.

Braking intervention

The warning prompts the driver himself/herself to react. During a warning, the maximum braking force is used. Premise for the brake booster is sufficiently quick and hard stepping on the brake pedal. The system can assist with some braking intervention if there is risk of a collision. At low speeds vehicles may thus come to a complete stop.

The braking intervention is executed only if DSC Dynamic Stability Control is switched on.

The braking intervention can be interrupted by stepping on the accelerator pedal or by actively moving the steering wheel.

Object detection can be restricted. Limitations of the detection range and functional restrictions are to be considered.

System limits

Detection range

The system's detection potential is limited.

Thus a warning might not be issued or be issued late.

E. g. the following situations may not be detected:

- ▶ Slow moving vehicles when you approach them at high speed.
- ▶ Vehicles that suddenly swerve in front of you, or sharply decelerating vehicles.
- ▶ Vehicles with an unusual rear appearance.
- ▶ Two-wheeled vehicles ahead of you.

Functional limitations

The system may not be fully functional in the following situations:

- ▶ In heavy fog, rain, sprayed water or snow-fall.
- ▶ In tight curves.

- ▶ If the driving stability control systems are deactivated, e.g. DSC OFF.
- ▶ If the field of view of the camera in the mirror is dirty or obscured.
- ▶ Up to 10 seconds after drive readiness is established.
- ▶ During calibration of the camera immediately after vehicle shipment.
- ▶ If there is constant blinding effects because of oncoming light, e. g., from the sun low in the sky.

Warning sensitivity

The more sensitive the warning settings are, e.g. the warning time, the more warnings are displayed. However, there may also be an excess of false warnings.

Pedestrian warning with city braking function

The concept

The system can help prevent accidents with pedestrians.

The system issues a warning in the city driving speed area if there is imminent danger of a collision with pedestrians and includes a braking function.

The camera in the area of the rearview mirror controls the system.

General information

In daylight the system warns of possible collisions with pedestrians at speeds from about 6 mph/10 km/h to about 35 mph/60 km/h shortly before a collision the system supports you with a braking intervention.

Under those circumstances it reacts to people who are within the detection range of the system.

Detection range

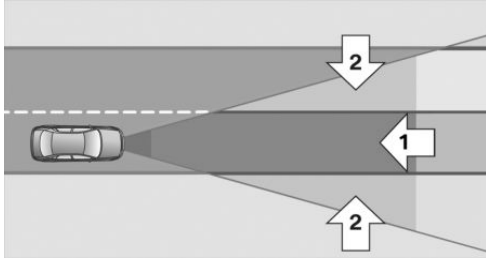

The detection area in front of the vehicle is divided into two areas.

- ▷ Central area, arrow 1, directly in front of the vehicle.
- ▷ Expanded area, arrow 2, to the right and left.

A collision is imminent if pedestrians are located within the central area. A warning is issued about pedestrians who are located within the extended area only if they are moving in the direction of the central area.

Hints



Personal responsibility

The system does not serve as a substitute for the driver's personal judgment of the traffic situation.

Be aware of the traffic situation and the vehicle's surroundings at all times, otherwise accidents are still possible despite all warnings. ◀



Adapting your speed and driving style

The displays and warnings of the system do not relieve the driver of the responsibility to adapt his or her driving speed and style to the traffic conditions. ◀



Be alert

Due to system limitations, warnings may be not issued at all, or may be issued late or improperly. Therefore, always be alert and ready to intervene; otherwise, there is the risk of an accident. ◀

At a glance

Button in the vehicle



Intelligent Safety button

Camera



The camera is found near the interior rearview mirror.

Keep the windshield in the area behind the interior rearview mirror clean and clear.

Switching on/off

Switching on automatically

The system is automatically active after every driving-off.

Switching on/off manually



Press button briefly:

- ▷ The menu for the intelligent safety system is displayed. The systems are individually switched off according to their respective settings.

- ▶ LED lights up orange or goes out respective to their individual settings.

Adjust as needed. Individual settings are stored for the profile currently in use.



Press button again:

- ▶ All Intelligent Safety systems are activated.
- ▶ The LED lights up green.



Hold down button:

- ▶ All Intelligent Safety systems are turned off.
- ▶ The LED goes out.

Warning with braking function

Display

If a collision with a person detected in this way is imminent, a warning symbol appears on the instrument cluster and in the Head-up Display.



The red symbol is displayed and a signal sounds.

Intervene immediately by braking or make an evasive maneuver.

Braking intervention

The warning prompts the driver himself/herself to react. During a warning, the maximum braking force is used. Premise for the brake booster is sufficiently quick and hard stepping on the brake pedal. The system can assist with some braking intervention if there is risk of a collision. At low speeds vehicles may thus come to a complete stop.

The braking intervention is executed only if DSC Dynamic Stability Control is switched on.

The braking intervention can be interrupted by stepping on the accelerator pedal or by actively moving the steering wheel.

Object detection can be restricted. Limitations of the detection range and functional restrictions are to be considered.

System limits

Detection range

The detection potential of the camera is limited.

Thus a warning might not be issued or be issued late.

E. g. the following situations may not be detected:

- ▶ Partially covered pedestrians.
- ▶ Pedestrians that are not detected as such because of the viewing angle or contour.
- ▶ Pedestrians outside of the detection range.
- ▶ Pedestrians having a body size less than 32 in/80 cm.

Functional limitations

The system may not be fully functional or may not be available in the following situations:

- ▶ In heavy fog, rain, sprayed water or snowfall.
- ▶ In tight curves.
- ▶ If the driving stability control systems are deactivated, e.g. DSC OFF.
- ▶ If the camera viewing field or the front windshield are dirty or covered.
- ▶ Up to 10 seconds after drive readiness is established.
- ▶ During calibration of the camera immediately after vehicle shipment.
- ▶ If there is constant blinding effects because of oncoming light, e. g., from the sun low in the sky.
- ▶ When it is dark outside.

Brake force display

The concept



- ▷ During normal brake application, the top brake lights light up.
- ▷ During heavy brake application, the lower brake lights light up in addition.

امداد خودرو فارما

تلفن شبانه روزی: ۰۲۱-۸۸۸۶۲۰۸۵

FarmaSOS.com

Driving stability control systems

Vehicle features and options

This chapter describes all standard, country-specific and optional features offered with the series. It also describes features that are not necessarily available in your car, e. g., due to the selected options or country versions. This also applies to safety-related functions and systems. The respectively applicable country provisions must be observed when using the respective features and systems.

Antilock Brake System ABS

ABS prevents locking of the wheels during braking.

The vehicle contains its steering power even during full brake applications, thus increasing active safety.

ABS is ready when car is ready to drive.

Brake assistant

When you apply the brakes rapidly, this system automatically produces the greatest possible braking force boost. It reduces the braking distance to a minimum during emergency stop. This system utilizes all of the benefits provided by ABS.

Do not reduce the pressure on the brake pedal for the duration of the emergency stop.

DSC Dynamic Stability Control

The concept

DSC prevents traction loss in the power wheels when driving off and accelerating.

DSC also recognizes unstable vehicle conditions such as fishtailing or nose-diving. Within the physical limits DSC helps to keep the vehicle on a steady course by reducing engine speed and by applying brakes to the individual wheels.

A change in the drive type, refer to page 32, can be made to improve traction.

Note



Adjust your driving style to the situation. An appropriate driving style is always the responsibility of the driver.

The laws of physics cannot be repealed, not even with DSC.

Therefore, do not reduce the additional safety margin by driving in a risky manner. ◀



Do not deactivate DSC when driving with roof load.

Do not deactivate Dynamic Stability Control DSC when driving with roof load, e.g. roof-mounted luggage rack.

Otherwise, driving safety is not given in driving-critical situation due to the elevated center of gravity. ◀

Overview

Button in the vehicle





DSC OFF button

Indicator/warning lights



The indicator lamp flashes: DSC controls the drive and braking forces.

The indicator lamp lights up: DSC has failed.

Deactivating DSC: DSC OFF



Automatic switching of the drive type

Depending on the operating state of the high-voltage system, the drive of the vehicle automatically switches between front-wheel, rear-wheel and four-wheel drive.

If DSC is deactivated, this may result in automatic change of the drive type for unstable driving situations.

To increase vehicle stability, activate DSC again as soon as possible. ◀

When DSC is deactivated, driving stability is reduced during acceleration and when driving in curves.

To increase vehicle stability, activate DSC again as soon as possible.

Deactivating DSC



Press and hold this button but not longer than approx. 10 seconds, until the indicator lamp for DSC OFF lights up in the instrument cluster and displays DSC OFF.

The DSC system is switched off.

The steering and, depending on the equipment, suspension are tuned for sporty driving.

Activating DSC



Press button.

DSC OFF and the DSC OFF indicator lamp go out.

Indicator/warning lights

When DSC is deactivated, DSC OFF is displayed in the instrument cluster.



The indicator lamp lights up: DSC is deactivated.

Automatic activation

When DSC is deactivated, automatic activation occurs in the following situations:

- ▷ The high-voltage battery has an insufficient charge.
- ▷ The vehicle has a flat tire.
- ▷ When activating cruise control in TRACTION or DSC OFF mode.

DTC Dynamic Traction Control

The concept

The DTC system is a version of the DSC where forward momentum is optimized.

The system ensures maximum headway on special road conditions or loose road surfaces, e.g., unplowed snowy roads, but with somewhat limited driving stability.

Activating the Dynamic Traction Control DTC provides maximum traction. Driving stability is limited during acceleration and when driving in curves.

Therefore drive with appropriate caution.

You may find it useful to briefly activate DTC under the following special circumstances:

- ▷ When driving in slush or on uncleared, snow-covered roads.
- ▷ When freeing vehicle from deep snow or driving off from loose grounds.
- ▷ When driving with snow chains.

Deactivating/activating DTC Dynamic Traction Control

Activating DTC



Press button.

TRACTION is displayed in the instrument cluster and the indicator lamp for DSC OFF lights up.

Deactivating DTC



Press button again.

TRACTION and the DSC OFF indicator lamp go out.

Performance Control

Performance Control enhances the agility of the vehicle.

To increase maneuverability, with a correspondingly sporty driving style, wheels are braked individually. The resulting braking power is simultaneously largely compensated by an engine intervention.

Due to the variable drive configuration, this intervention can be done either on the front axle, the rear axle or on both axles simultaneously.

Driving Dynamics Control

The concept

The Driving Dynamics Control helps to fine-tune the vehicle's settings and features. Various programs can be selected for this purpose.

Note

Pressing the Driving Dynamics Control deactivates the Sport program, refer to page 72, of the vehicle. The selector lever automatically switches out of the Sport program in selector lever position D. Use the Driving Dynamics

Control to select the COMFORT or ECO PRO programs.

Overview

Button in the vehicle



Operating the programs

Driving Dynamics Control	Program
	COMFORT
	ECO PRO



COMFORT

For balanced tuning.

With each starting operation, COMFORT is activated using the Start/Stop button.

Activating COMFORT



Press button repeatedly until COMFORT is displayed in the instrument cluster.

ECO PRO

ECO PRO, refer to page 145, provides consistent tuning to maximize range.

Comfort functions and the engine controller are adjusted.

The program can be configured to individual specifications.

Activating ECO PRO



Press button repeatedly until ECO PRO is displayed in the instrument cluster.

Configuring ECO PRO

1. Activate ECO PRO.
2. "Configure ECO PRO"

Make the desired settings.

Displays

Selected program

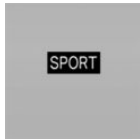

The instrument cluster displays the selected program.

Display on the Control Display

Program changes can be displayed on the Control Display.

1. "Settings"
2. "Control display"
3. "Driving mode info"



Driving off without delay

After releasing the foot brake, start driving without delay, since the drive-off assistant will not hold the vehicle in place for more than approx. 2 seconds and the vehicle will begin to roll back. ◀

امداد خودرو فارما

تلفن شبانه روزی: ۰۲۱-۸۸۸۶۲۰۸۵

FarmaSOS.com

Drive-off assistant

This system supports driving off on inclines. The parking brake is not required.

1. Hold the vehicle in place with the foot brake.
2. Release the foot brake and drive off without delay.

After the foot brake is released, the vehicle is held in place for approx. 2 seconds.

Depending on the vehicle load, the vehicle may roll back slightly.

Driving comfort

Vehicle features and options

This chapter describes all standard, country-specific and optional features offered with the series. It also describes features that are not necessarily available in your car, e. g., due to the selected options or country versions. This also applies to safety-related functions and systems. The respectively applicable country provisions must be observed when using the respective features and systems.

Cruise control

The concept

The system maintains a preset speed via the buttons on the steering wheel. The system brakes on downhill gradients if engine braking is insufficient.

General information

Depending on the driving settings, the features of the cruise control can change in certain areas.

Hints

 Unfavorable conditions





Do not use the system if unfavorable conditions make it impossible to drive at a constant speed, e.g.:

- ▷ On winding roads.
- ▷ In heavy traffic.
- ▷ On slippery roads, in fog, snow or rain, or on a loose road surface.

Otherwise, you could lose control of the vehicle and cause an accident. ◀

Overview

Buttons on the steering wheel

Press button	Function
	System on/off, interrupt
	Store speed
	Resume speed
	rocker switch: change, hold, store speed

Controls

Switching on

 Press button on the steering wheel.

 The indicator lamp in the instrument cluster lights up.

 Desired speed becomes current speed and will be displayed - beside the symbol - in the Info Display.

Cruise control can be used.

Switch off

 Deactivated or interrupted system

With deactivated or interrupted system use your brakes, steering and moves as usual to avoid the chance of an accident. ◀

 Press button.

- ▷ If active: press twice.
- ▷ If interrupted: press once.

The displays go out. The stored desired speed is deleted.

Interrupting

 When active, press the button.

The system is automatically interrupted if:

- ▷ The brakes are applied.
- ▷ Selector lever position D is disengaged.
- ▷ DTC Dynamic Traction Control is activated or DSC is deactivated.
- ▷ DSC is actively controlling stability.

Maintaining, storing, and changing the speed

Hints

 Adjusting the desired speed
Modify desired speed to road conditions and be ready to brake at all times; otherwise, there is the risk of an accident. ◀

Maintaining/storing the speed

 Press button.
Or:

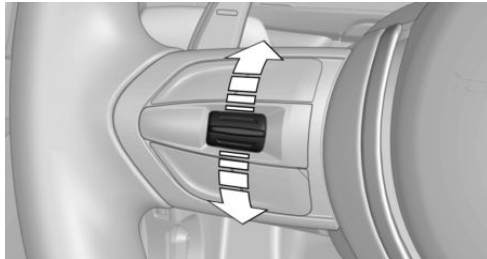

Press the rocker switch while the system is interrupted.

When the system is switched on, the current speed is maintained and stored as the desired speed.

This is displayed in the instrument cluster.

When cruise control is maintained or stored, DSC Dynamic Stability Control will be turned on if needed.

Changing the speed

Press the rocker switch up or down repeatedly until the desired speed is set.

If active, the displayed speed is stored and the vehicle reaches the stored speed when the road is clear.

- ▷ Each time the rocker switch is pressed to the point of resistance, the desired speed increases or decreases by approx. 1 mph/1 km/h.

- ▷ Each time the rocker switch is pressed past the point of resistance, the desired speed increases or decreases by a maximum of 5 mph/10 km/h.

The maximum speed that can be set depends on the vehicle.

- ▷ Pressing the rocker switch to the resistance point and holding it accelerates or decelerates the vehicle without requiring pressure on the accelerator pedal.

After the rocker switch is released, the vehicle maintains its final speed. Pressing the switch beyond the resistance point causes the vehicle to accelerate more rapidly.

Resuming the desired speed

 Press button.

The stored speed is reached and maintained.

Displays in the instrument cluster

Indicator lamp

 Depending on how the vehicle is equipped, the indicator lamp in the instrument cluster indicates whether the system is switched on.

Desired speed



The desired speed is displayed next to the symbol in the info display.

- ▶ The indicator lights up green: the system is active.
- ▶ The indicator lights up orange: the system has been interrupted.
- ▶ No display: system is switched off.

Brief status display



Selected desired speed.

If --- appears briefly on the display for Check Control messages, it is possible that the system requirements are currently not ready for operations.

Displays in the Head-up Display

Some system information can also be displayed in the Head-up Display.

PDC Park Distance Control

The concept

PDC is a support when parking. When you slowly approach an object in the rear - or also in the front of the vehicle if the feature is available - then the object is reported through:

- ▶ Signal tones.
- ▶ Visual display.

General information

Ultrasound sensors in the bumpers measure the distances from objects.

The maneuvering range, depending on the obstacle and environmental conditions, is approx. 6 ft/2 m.

An acoustic warning is first given:

- ▶ By the front sensors and the two rear corner sensors at approx. 24 in/60 cm.

- ▶ By the rear middle sensors at approx. 5 ft/1.50 m.

To ensure full functionality:

- ▶ Do not cover sensors, e.g., with stickers, bicycle racks.
- ▶ Keep the sensors clean and free of ice.
- ▶ When using high-pressure washers, do not spray the sensors for long periods and maintain a distance of at least 12 in/30 cm.

Hints



Personal responsibility

Even an active system does not relieve the driver from personal responsibility while driving.

Technically the system has its limits, it cannot independently react to all traffic situations.

Monitor your driving, be on the alert, observe the vehicle surroundings and other traffic and react when needed - risk of accident. ◀



Avoid driving fast with PDC

Avoid approaching an object too fast.

Avoid driving off fast while PDC is not yet active.

For technical reasons, the system may otherwise be too late in issuing a warning. ◀

Overview

With front PDC: button in vehicle



PDC Park Distance Control

Switching on/off

Switching on automatically

PDC switches on automatically in the following situations:

- ▷ If selector lever position R is engaged while the engine is running or in electric mode.
The rearview camera also switches on.
- ▷ If equipped with front PDC: when obstacles are detected behind or in front of the vehicle by PDC and the speed is slower than approx. 2.5 mph/4 km/h.

You may turn off automatic activation:

1. "Settings"
2. "Parking"
3. Select setting.
Settings are stored for the profile currently in use.

Automatic deactivation during forward travel

The system switches off when a certain driving distance or speed is exceeded.

Switch the system back on if needed.

With front PDC: switching on/off manually



Press button.

- ▷ On: the LED lights up.
- ▷ Off: the LED goes out.

The rearview camera image is displayed when the reverse gear is engaged by pressing the button.

Display

Signal tones

When approaching an object, an intermittent sound indicates the position of the object. E. g. if an object is detected to the left rear of the

vehicle, a signal tone sounds from the left rear speaker.

The shorter the distance to the object, the shorter the intervals.

If the distance to a detected object in the front is less than approx. 12 in/30 cm and in the rear less than approx. 20 in/50 cm, a continuous tone is sounded.

With front PDC: if objects are located both in front of and behind the vehicle, an alternating continuous signal is sounded.

The signal tone is switched off, when selector lever position P is engaged on vehicles with Steptronic transmission.

Volume

The volume of the PDC signal tone can be adjusted similar to the sound and volume settings of the radio.

Settings are stored for the profile currently in use.

Visual warning

The approach of the vehicle to an object can be shown on the Control Display. Objects that are farther away are already displayed on the Control Display before a signal sounds.

A display appears as soon as Park Distance Control (PDC) is activated.

The range of the sensors is represented in the colors green, yellow and red.

When the image of the rearview camera is displayed, the reel can be made to PDC:

🔊 "Rear view camera"

System limits

Limits of ultrasonic measurement

Ultrasonic measuring might not function under the following circumstances:

- ▷ For small children and animals.

- ▷ For persons with certain clothing, e.g. coats.
- ▷ With external interference of the ultrasound, e.g. from passing vehicles or loud machines.
- ▷ When sensors are dirty, iced over, damaged or out of position.
- ▷ Under certain weather conditions such as high relative humidity, rain, snowfall, extreme heat or strong wind.
- ▷ With tow bars and trailer couplings of other vehicles.
- ▷ With thin or wedge-shaped objects.
- ▷ With moving objects.
- ▷ With elevated, protruding objects such as ledges or cargo.
- ▷ With objects with corners and sharp edges.
- ▷ With objects with a fine surface structure such as fences.
- ▷ For objects with porous surfaces.

Low objects already displayed, e.g., curbs, can move into the blind area of the sensors before or after a continuous tone sounds.

False warnings

PDC may issue a warning under the following conditions even though there is no obstacle within the detection range:

- ▷ In heavy rain.
- ▷ When sensors are very dirty or covered with ice.
- ▷ When sensors are covered in snow.
- ▷ On rough road surfaces.
- ▷ On uneven surfaces, such as speed bumps.
- ▷ In large buildings with right angles and smooth walls, e.g., in underground garages.
- ▷ In automatic car washes.
- ▷ Through heavy pollution.

- ▷ Due to other ultrasound sources, e.g., sweeping machines, high pressure steam cleaners or neon lights.

Malfunction

A Check Control message is displayed.



Red symbol is displayed, and the range of the sensors is dimmed on the Control Display.

PDC has failed. Have the system checked.

To ensure full functionality:

- ▷ Keep the sensors clean and free of ice.
- ▷ dimmed Do not put any stickers on sensors.
- ▷ When using high-pressure washers, do not spray the sensors for long periods and maintain a distance of at least 12 in/30 cm.

Surround View

The concept

Surround View comprises various camera assistance systems that help the driver when parking, maneuvering, and at complex exits and intersections.

- ▷ Rearview camera, refer to page 117
- ▷ Top View, refer to page 120.
- ▷ Side View, refer to page 122.

Rearview camera

The concept

The rearview camera provides assistance in parking and maneuvering backwards. The area behind the vehicle is shown on the Control Display.

Hints



Check the traffic situation as well

Check the traffic situation around the vehicle with your own eyes. Otherwise, an accident could result from road users or objects that are not detected by the camera. ◀

At a glance

Button in the vehicle



Rearview camera

Camera

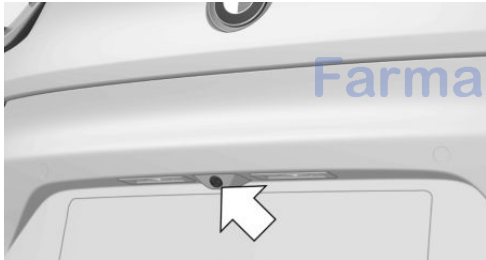

The camera lens is located between the license plate lights. The image quality may be impaired by dirt.

Clean the camera lens, refer to page 190.

Switching on/off

Switching on automatically

Engage selector lever position R with the engine running or drive readiness switched on.

Automatic deactivation during forward travel

The system switches off when a certain driving distance or speed is exceeded.

Switch the system back on if needed.

Switching on/off manually



Press button.

- ▷ On: the LED lights up.
- ▷ Off: the LED goes out.

The PDC is shown on the Control Display.

The rearview camera image is displayed when the reverse gear is engaged by pressing the button.

Switching the view via iDrive

With PDC activated or Top View switched on:

⌘ "Rear view camera"

The rearview camera image is displayed.

Display on the Control Display

Functional requirement

- ▷ The rearview camera is switched on.
- ▷ The trunk lid is fully closed.

Activating assistance functions

More than one assistance function can be active at the same time.

- ▷ Parking aid lines
 - ⌘ "Parking aid lines"
 - Lanes and turning radius are indicated.
- ▷ Obstacle marking
 - ⌘ "Obstacle marking"
 - Spatially-shaped markings are displayed.

Pathway lines

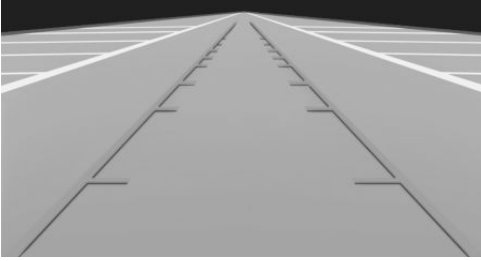

- ▶ Pathway lines can be superimposed on the image of the rearview camera.
- ▶ They help you to estimate how much space is needed when parking and maneuvering on level pavement.
- ▶ They are dependent on the current steering angle and are continuously adjusted to the steering wheel movements.

Turning circle lines

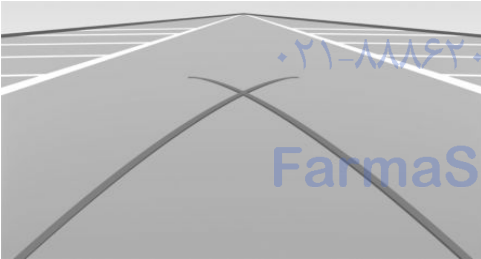

- ▶ Turning circle lines can only be superimposed on the rearview camera image together with pathway lines.
- ▶ They show the course of the smallest possible turning radius on a level road.
- ▶ Only one turning radius line is displayed after the steering wheel is turned past a certain angle.

Obstacle marking

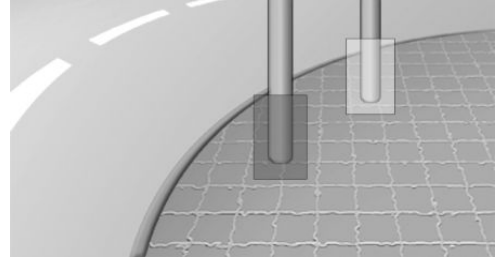

Obstacles behind the vehicle are detected by the PDC sensors and, when respectively equipped, detected by the rearview camera.

Obstacle markings can be faded into the image of the rearview camera.

Their colored margins match the markings of the PDC. This simplifies estimation of the distance to the object shown.

Parking using pathway and turning radius lines

1. Position the vehicle so that the turning radius lines lead to within the limits of the parking space.

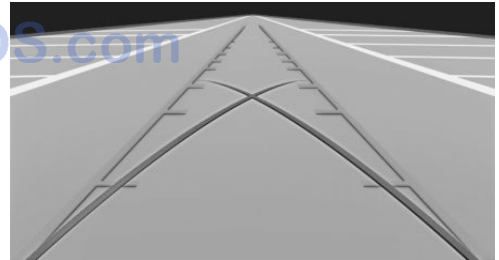

- Turn the steering wheel to the point where the pathway line covers the corresponding turning radius line.

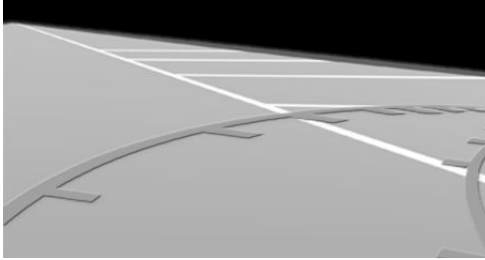

Display settings

Brightness

With the rearview camera switched on:

-  Select the symbol.
- Turn the controller until the desired setting is reached, and press the controller.

Contrast

With the rearview camera switched on:

-  Select the symbol.
- Turn the controller until the desired setting is reached, and press the controller.

System limits

Detection of objects

Very low obstacles as well as high, protruding objects such as ledges may not be detected by the system.

Assistance functions also take into account data of the PDC.

Follow instructions in the PDC chapter, refer to page 115.

The objects displayed on the Control Display under certain circumstances are closer than they appear. Do not estimate the distance from the objects on the display.

Top View

The concept

Top View provides assistance in parking and maneuvering. The area around the vehicle is shown on the Control Display.

General information

The image is captured by two cameras integrated in the exterior mirrors, by the rearview camera and a camera on the front of the vehicle.

The range is no more than approx. 6.5 ft/2 m to the side, front and rear.

Obstacles within this range are thus displayed early on the Control Display.

Hints



Check the traffic situation as well

Check the traffic situation around the vehicle with your own eyes. Otherwise, an accident could result from road users or objects that are not captured by the camera. ◀

Overview

Button in the vehicle



Top View

Cameras

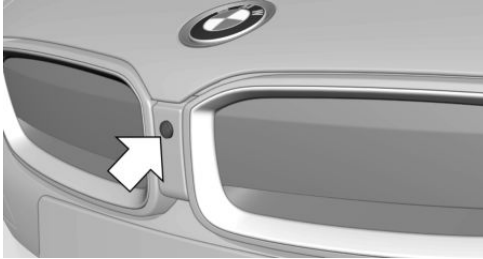

Front camera

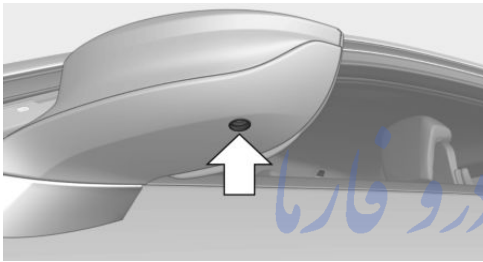

The lenses of the Top View cameras are located at the bottom of the exterior mirror housings. The image quality may be impaired by dirt.

Clean the camera lenses, refer to page 190.

Functional requirements

Top View can be used only to a limited extent in the following situations:

- ▷ With a door open.
- ▷ With the trunk lid open.
- ▷ With an exterior mirror folded in.
- ▷ In poor light.

The unavailable camera range is depicted by shading.

Switching on/off

Switching on automatically

With the engine running, engage lever in position P R.

The rearview camera image is displayed. To switch to the Top View:

 "Rear view camera"

Automatic deactivation during forward travel

The system switches off when a certain driving distance or speed is exceeded.

Switch the system back on if needed.

Switching on/off manually

 Press button.

- ▷ On: the LED lights up.
- ▷ Off: the LED goes out.

Top View is displayed.

The rearview camera image is displayed when the reverse gear is engaged by pressing the button.

Display

Display on the Control Display

The area surrounding the vehicle can be displayed on the Control Display.

The display appears as soon as Top View is activated.

When the image of the rearview camera is displayed, it is possible to reel to top view:

 "Rear view camera"

Brightness

With Top View switched on:

1.  Select the symbol.
2. Turn the controller until the desired setting is reached, and press the controller.

Contrast

With Top View switched on:

1.  Select the symbol.

- Turn the controller until the desired setting is reached, and press the controller.

Displaying the turning radius and pathway lines

- The static, red turning radius line shows the space needed to the side of the vehicle when the steering wheel is turned all the way.
- The variable, green pathway line assists you in assessing the amount of space actually needed to the side of the vehicle. The lane line depends on the engaged gear and the current steering angle. The track line is continuously adjusted for the steering wheel movement.

"Parking aid lines"

Turning circle and pathway lines are displayed.

System limits

A Check Control message is displayed when a camera is defective.

Side View

The concept

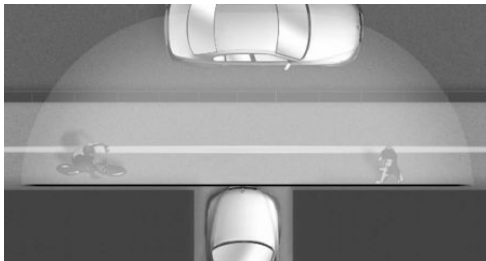

Side View provides an early look at cross traffic at blind driveways and intersections. Road users concealed by obstacles to the left and right of the vehicle can only be detected relatively late from the driver's seat. To improve the viewing, each camera, front and rear on the vehicle, detects the traffic area on the side.

Which camera is active is shown on the top edge of the screen.

Hints

The images of the cameras are displayed, depending on the gear selected, on the Control Display.



Check the traffic situation as well

Check the traffic situation around the vehicle on blind driveways and intersections with your own eyes. Otherwise, an accident could result from road users or objects located outside the picture areas of the Side View cameras. ◀

At a glance

Button in the vehicle



Side View

Cameras

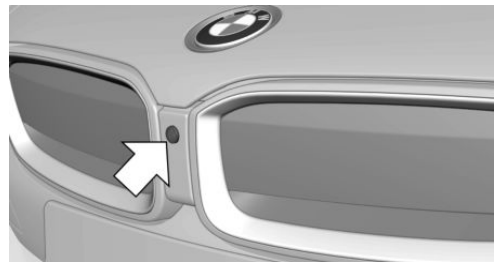

Front camera

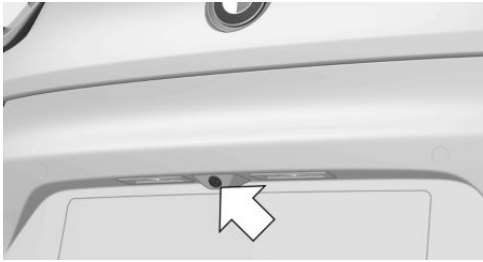

Rear camera

Two cameras are used for the detection.
The image quality may be impaired by dirt.
Clean the camera lenses, refer to page 190.

Switching on/off

Switching on/off manually



Press button.

Depending on the transmission position, the picture of the front or rear camera is displayed.

Switching off automatically

By switching into a different function or when changing gears.

Front Side View: when a certain driving distance or speed is exceeded.

Display

General information

The traffic area in front of or behind the vehicle is displayed on the Control Display.

Brightness

With the Side View switched on:

1. ☀ Select the symbol.
2. Turn the controller until the desired setting is reached, and press the controller.

Contrast

With the Side View switched on:

1. ● Select the symbol.
2. Turn the controller until the desired setting is reached, and press the controller.

Warning of crossing traffic

The concept

When an object approaching from the side is detected by the front or rear camera, this is depicted by a symbol in the Side View display.

Requirements

- ▷ Side View switched on.
- ▷ Your vehicle moves no faster than walking speed.
- ▷ To detect approaching objects, sufficient brightness, e.g., daylight is necessary.

Display



The yellow symbol is displayed if an approaching vehicle is detected by the camera.



A gray symbol is displayed if crossing traffic cannot be detected.

System limits

In the following situations, the warning about crossing traffic may be limited:

- ▷ In poor lighting or visibility conditions.
- ▷ If the camera is soiled or covered.

System limits

The objects displayed on the Control Display under certain circumstances are closer than they appear. Therefore, do not estimate the distance from the objects on the display.

The viewing angle is approx. 180°.

Climate control

Vehicle features and options

This chapter describes all standard, country-specific and optional features offered with the series. It also describes features that are not necessarily available in your car, e. g., due to

the selected options or country versions. This also applies to safety-related functions and systems. The respectively applicable country provisions must be observed when using the respective features and systems.

Automatic climate control

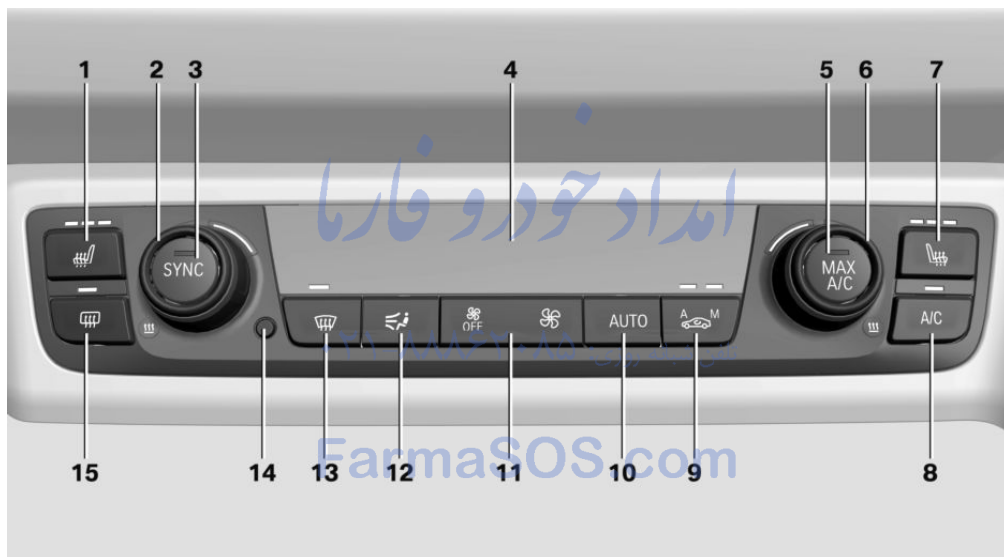

- | | |
|--|--|
| <ul style="list-style-type: none"> 1 Seat heating, left 52 2 Temperature, left 3 SYNC program 4 Display 5 Maximum cooling 6 Temperature, right 7 Seat heating, right 52 8 Cooling function 9 Automatic recirculated-air control/recirculated-air mode | <ul style="list-style-type: none"> 10 AUTO program 11 Air flow, AUTO intensity 12 Manual air distribution 13 Defrosts windows and removes condensation 14 Interior temperature sensor — always keep clear 15 Rear window defroster |
|--|--|

Hints



Sufficient ventilation

When remaining in the vehicle for an extended period of time, ensure sufficient external ventilation. Do not continuously use recirculated-air mode; otherwise the air quality in the interior continuously deteriorates and window condensation increases. ◀

Climate control functions in detail

Temperature



Turn the ring to set the desired temperature.

The selected temperature is shown on the display of the automatic climate control.

The automatic climate control reaches this temperature as quickly as possible, if needed by increasing the cooling or heating output, and then keeps it constant.

Do not rapidly switch between different temperature settings. Otherwise, the automatic climate control will not have sufficient time to adjust the set temperature.

To reduce the energy consumption, the cooling or heating output is reduced in ECO-PRO mode, refer to page 145. ECO PRO is shown on the display of the automatic climate control.

SYNC program



Press button.

The current setting of the temperature on the driver's side is transferred to the front passenger side.

The program is switched off if the setting on the front passenger side is changed.

Maximum cooling



Press button.

The system is set to the lowest temperature, optimum air flow and air circulation mode.

Air flows out of the vents to the upper body region. The vents need to be open for this.

The function is available above an external temperature of approx. 32 °F/0 °C and with the engine running or when electrical drive readiness is indicated.

Adjust air flow with the program active.

Cooling function

The car's interior can be cooled with the stationary climate control or via the A/C button with the engine running and/or with drive readiness activated.



Press button.

The air will be cooled and dehumidified and, depending on the temperature setting, warmed again.

Depending on the weather, the windshield and side windows may fog up briefly when the engine is started or drive readiness is activated.

The cooling function is switched on automatically with the AUTO program.

When using the automatic climate control, condensation water, refer to page 141, develops that exits underneath the vehicle.

Automatic recirculated-air control/ recirculated-air mode

You may respond to unpleasant odors or pollutants in the immediate environment by temporarily suspending the supply of outside air. The system then recirculates the air currently within the vehicle.



Press button repeatedly to select an operating mode:

- ▷ LEDs off: outside air flows in continuously.
- ▷ Left LED on, automatic recirculated-air control: a sensor detects pollutants in the outside air and shuts off automatically.
- ▷ Right LED on, recirculated-air mode: the supply of outside air into the vehicle is permanently blocked.

Recirculated air mode switches off automatically at low external temperatures after a certain amount of time in order to avoid window fogging.

To prevent window fogging, recirculated air mode switches off automatically after a certain amount of time, depending on the environmental conditions.

If the windows are fogged over, switch off the recirculated-air mode and press the AUTO button to utilize the condensation sensor. Make sure that air can flow to the windshield.

Sufficient ventilation

When remaining in the vehicle for an extended period of time, ensure sufficient external ventilation. Do not continuously use recirculated-air mode; otherwise the air quality in the interior continuously deteriorates and window condensation increases. ◀

AUTO program

 Press button. Air flow, air distribution and temperature are controlled automatically.

Depending on the selected temperature, AUTO intensity program and outside influences, the air is directed to the windshield, side windows, upper body, and into the footwell.

The cooling function, refer to page 125, is switched on automatically with the AUTO program.

At the same time, a condensation sensor controls the program so as to prevent window condensation as much as possible.

To switch off the program: press the button again or manually adjust the air distribution.

Intensity of the AUTO program

With the AUTO program activated, the automatic intensity control can be changed.

 Press the left or right side of the button: decrease or increase the intensity.

The selected intensity is shown on the display of the automatic climate control.

Air flow, manual

To manually adjust air flow turn off AUTO program first.

 Press the left or right side of the button: decrease or increase air flow.

The selected air flow is shown on the display of the automatic climate control.

The air flow of the automatic climate control may be reduced automatically to save battery power. تلفن شبانه روزی

Manual air distribution

 Press button repeatedly to select a program:

- ▷ Windows.
- ▷ Upper body region.
- ▷ Footwell.
- ▷ Windows and upper body region.
- ▷ Windows and footwell.
- ▷ Upper body region and footwell.
- ▷ Windows, upper body region, and footwell.

The selected air distribution is shown on the display of the automatic climate control.

If the windows are fogged over, press the AUTO button to utilize the condensation sensor.

Defrosts windows and removes condensation



Press button.

Ice and condensation are quickly removed from the windshield and the front side windows.

For this purpose, point the side vents onto the side windows as needed.

Adjust air flow with the program active.

If the windows are fogged over, you can also switch on the cooling function or press the AUTO button to utilize the condensation sensor.

Rear window defroster



Press button.

The rear window defroster switches off automatically after a certain period of time.

Switching the system on/off

Switch off



Press and hold the left button until the control switches off.

Switching on

Press any button except

- ▷ Rear window defroster.
- ▷ Seat heating.

Microfilter/activated-charcoal filter

In external and recirculated air mode the microfilter/activated charcoal filter filters dust, pollen, and gaseous pollutants out of the air.

This filter should be replaced during scheduled maintenance, refer to page 178, of your vehicle.

Ventilation

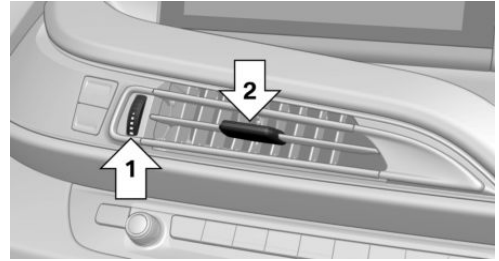

- ▷ Thumbwheel for continuous opening and closing of the vent, arrow 1.
- ▷ Lever for changing the air flow direction, arrow 2.

Adjusting the ventilation

- ▷ Ventilation for cooling:
 - Direct vent in your direction when vehicle's interior is too hot.
- ▷ Draft-free ventilation:
 - Adjust the vent to let the air flow past you.

Stationary climate control

The concept

Stationary climate control cools or heats the interior prior to departure to a comfortable temperature.

The interior temperature is lowered with high cooling output.

The system may heat the interior. Snow and ice can be removed more easily.

The air automatically exits through the vents to the windshield, the side windows, the upper body region and into the footwell.

The stationary climate control can be switched on and off via the following systems:

- ▷ Direct operation, refer to page 128.
- ▷ Preselected departure times, refer to page 128.

With the BMW i Remote App, refer to page 128, the standing air conditioning can be switched on.

The system switches off automatically after a certain period of time.

If stationary climate control is used during the charging process, less air conditioning capacity will be required while driving. This optimizes the range.

Functional requirements

- ▷ When the departure time is preselected: depends on internal, external and set temperature.
- ▷ Direct operation via iDrive: any external temperature.
- ▷ Charging cable connected or high-voltage battery sufficiently charged.
- ▷ Motor switched off and/or drive readiness deactivated.
- ▷ The vents are open to allow air to flow out.

Switching on/off directly • ۲۱-۸۸۸۶۲۰۸۵ :تلفن شبانه روزی

On the Control Display:

1. "Settings"
2. "Climate"
3. "Activate comfort climate control"

☞ The symbol on the automatic climate control flashes if the stationary climate control is switched on.

Activate climate control at departure time

The reel-on time is automatically determined based on the temperature. The system promptly switches on before the selected departure time.

On the Control Display:

1. "Settings"
2. "Departure time"
3. "Departure 1:"

4. "Precondition for departure time"

5. Set and activate Desired departure time, refer to page 156.

☞ The symbol on the automatic climate control lights up when the departure time is activated.

☞ The symbol on the automatic climate control flashes when the stationary climate control has been switched on.

If drive readiness is switched off, changes can be made on the Control Display. Departure time can only be changed once. Scheduled departure times are not adjusted. Settings for climate control and charging operation are also applied for scheduled departure times.

Activating with BMW i Remote App

Using the BMW i Remote App, the system can be directly switched on or via a preset departure time.

FarmaSOS.com

Interior equipment

Vehicle features and options

This chapter describes all standard, country-specific and optional features offered with the series. It also describes features that are not necessarily available in your car, e. g., due to the selected options or country versions. This also applies to safety-related functions and systems. The respectively applicable country provisions must be observed when using the respective features and systems.

Universal Integrated Remote Control

The concept

The universal garage door opener can operate up to 3 functions of remote-controlled systems such as garage door drives or lighting systems. The universal garage door opener replaces up to 3 different hand-held transmitters. To operate the remote control, the buttons on the interior rearview mirror must be programmed with the desired functions. The hand-held transmitter for the particular system is required in order to program the remote control.

! During programming
During programming and before activating a device using the universal garage door opener, ensure that there are no people, animals or objects in the area of the remote-controlled device; otherwise, there is a risk of injury or damage.

Also follow the safety instructions of the hand-held transmitter. ◀

Before selling the vehicle, delete the stored functions for the sake of security.

Compatibility



If this symbol is printed on the packaging or in the instructions of the system to be controlled, the system is generally compatible with the universal garage door opener.

If you have any questions, please contact:

- ▷ Your service center.
- ▷ www.homelink.com on the Internet.

HomeLink is a registered trademark of Gentex Corporation.

Control elements on the interior rearview mirror

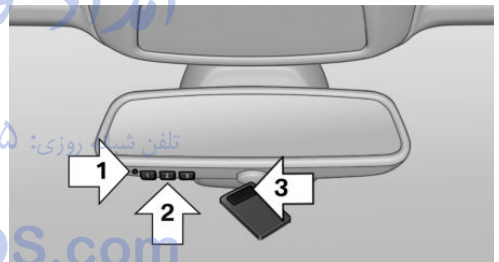

- ▷ LED, arrow 1.
- ▷ Buttons, arrow 2.
- ▷ The hand-held transmitter, arrow 3, is required for programming.

Programming

General information

1. Switch on the ignition.
2. Initial setup:

Press and hold the left and right button on the interior rearview mirror simultaneously for approximately 20 seconds until the LED on the interior rearview mirror flashes. This

erases all programming of the buttons on the interior rearview mirror.

3. Hold the hand-held transmitter for the system to be controlled approx. 1 to 3 in/2.5 to 8 cm away from the buttons of the interior rearview mirror. The required distance depends on the manual transmitter.
4. Simultaneously press and hold the button of the desired function on the hand-held transmitter and the button to be programmed on the interior rearview mirror. The LED on the interior rearview mirror will begin flashing slowly.
5. Release both buttons as soon as the LED flashes more rapidly. The LED flashing faster indicates that the button on the interior rearview mirror has been programmed. If the LED does not flash faster after at least 60 seconds, change the distance between the interior rearview mirror and the hand-held transmitter and repeat the step. Several more attempts at different distances may be necessary. Wait at least 15 seconds between attempts.

Canada: if programming with the hand-held transmitter was interrupted, hold down the interior rearview mirror button and repeatedly press and release the hand-held transmitter button for 2 seconds.

6. To program other functions on other buttons, repeat steps 3 to 5.

The systems can be controlled using the interior rearview mirror buttons.

Special feature of the alternating-code wireless system

If you are unable to operate the system after repeated programming, please check if the system to be controlled features an alternating-code system.

Read the system's operating manual, or press the programmed button on the interior rearview mirror longer. If the LED on the interior

rearview mirror starts flashing rapidly and then stays lit constantly for 2 seconds, the system features an alternating-code system. Flashing and continuous illumination of the LED will repeat for approximately 20 seconds.

For systems with an alternating-code system, the universal garage door opener and the system also have to be synchronized.

Please read the operating manual to find out how to synchronize the system.

Synchronizing is easier with the aid of a second person.

To synchronize:

1. Park the vehicle within range of the remote-controlled system.
2. Program the relevant button on the interior rearview mirror as described.
3. Locate and press the synchronizing button on the system being programmed. You have approx. 30 seconds for the next step.
4. Hold down the programmed button on the interior rearview mirror for approximately 3 seconds and then release it. If necessary, repeat this step up to three times in order to finish synchronization. Once synchronization is complete, the programmed function will be carried out.

Reprogramming individual buttons

1. Switch on the ignition.
2. Press and hold the interior rearview mirror button to be programmed.
3. As soon as the interior rearview mirror LED starts flashing slowly, hold the hand-held transmitter for the system to be controlled approx. 1 to 3 in/2.5 to 8 cm away from the buttons of the interior rearview mirror. The required distance depends on the manual transmitter.

4. Likewise, press and hold the button of the desired function on the hand-held transmitter.
5. Release both buttons as soon as the interior rearview mirror LED flashes more rapidly. The LED flashing faster indicates that the button on the interior rearview mirror has been programmed. The system can then be controlled by the button on the interior rearview mirror.

If the LED does not flash faster after at least 60 seconds, change the distance and repeat the step. Several more attempts at different distances may be necessary. Wait at least 15 seconds between attempts.

Canada: if programming with the hand-held transmitter was interrupted, hold down the interior rearview mirror button and repeatedly press and release the hand-held transmitter button for 2 seconds.

Controls



Before operation

Before operating a system using the universal garage door opener, ensure that there are no people, animals, or objects within the range of movement of the remote-controlled system; otherwise, there is a risk of injury or damage.

Also follow the safety instructions of the hand-held transmitter. ◀

The system, such as the garage door, can be operated using the button on the interior rearview mirror while the engine is running or when the ignition is started. To do this, hold down the button within receiving range of the system until the function is activated. The interior rearview mirror LED stays lit while the wireless signal is being transmitted.

Deleting stored functions

Press and hold the left and right button on the interior rearview mirror simultaneously for ap-

proximately 20 seconds until the LED flashes rapidly. All stored functions are deleted. The functions cannot be deleted individually.

Sun visor

Glare shield

Fold the sun visor down or up.

Vanity mirror

A vanity mirror is located in the sun visor behind a cover. When the cover is opened, the mirror lighting switches on.

Connecting electrical devices

Hints



Do not connect charging devices to the 12 volt socket in the vehicle

Do not connect battery chargers to the factory-installed 12 volt sockets in the vehicle as this may damage the vehicle battery due to an increased power consumption. ◀



Replace the cover after use

Reinsert the lighter or socket cover after use, otherwise objects may get into the lighter socket or fixture and cause a short circuit. ◀

Sockets

General information

The lighter socket can be used as a socket for electrical equipment while the engine is running or when the ignition is switched on.

Note

The total load of all sockets must not exceed 140 watts at 12 volts.

Do not damage the socket by using unsuitable connectors.

Center console

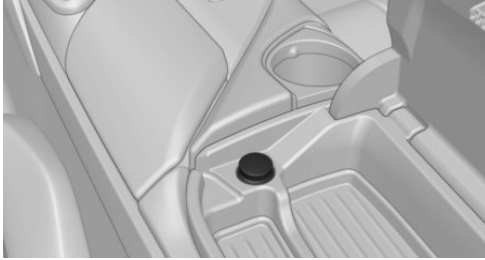

The socket is located between the front seats. Remove the cover.

In the front passenger footwell

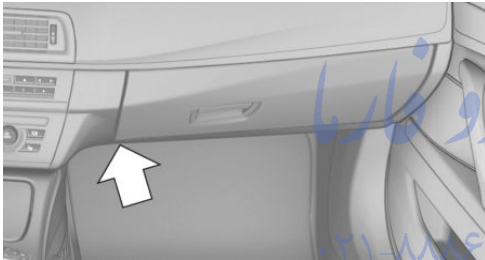

The socket is located below the glove compartment.

USB interface for data transfer

The concept

Connection for importing and exporting data on USB devices, e.g.:

- ▷ Personal Profile settings, refer to page 39.
- ▷ Music collection.
- ▷ Importing Trips.

Hints

Observe the following when connecting:

- ▷ Do not use force when plugging the connector into the USB interface.

- ▷ Do not connect devices such as fans or lights to the USB interface.
- ▷ Do not connect USB hard drives.
- ▷ Do not use the USB interface for recharging external devices.

At a glance

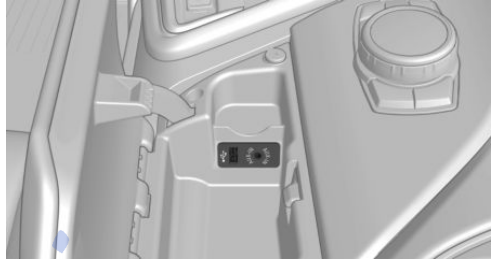

The socket is located between the front seats.

Cargo area

Cargo cover

General information

The cargo cover is located under the tailgate. The cover can be folded forward or removed to load bulky luggage.

Note

 Do not deposit any objects on the cargo cover

Do not deposit any objects on the cargo cover. Otherwise, this could damage the cargo cover or the cargo partition. ◀

Removing

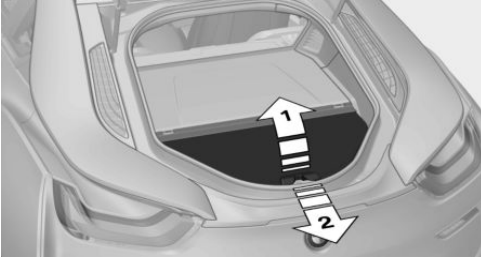

Raise the cover, arrow 1, and pull it back to remove, arrow 2.

Installing

Place the cover in the brackets and fold it down.

امداد خودرو فارما

تلفن شبانه روزی: ۰۲۱-۸۸۸۶۲۰۸۵

FarmaSOS.com

Storage compartments

Vehicle features and options

This chapter describes all standard, country-specific and optional features offered with the series. It also describes features that are not necessarily available in your car, e. g., due to the selected options or country versions. This also applies to safety-related functions and systems. The respectively applicable country provisions must be observed when using the respective features and systems.

Hints

 No loose objects in the car's interior
Do not stow any objects in the car's interior without securing them; otherwise, they may present a danger to occupants e.g., during braking and evasive maneuvers. ◀

 Do not place anti-slip mats on the dashboard

Do not place anti-slip mats on the dashboard. The mat materials could damage the dashboard. ◀

Storage compartments

The following storage compartments are available in the vehicle interior:

- ▷ Glove compartment on the front passenger side, refer to page 134.
- ▷ Between the front seats, refer to page 134.
- ▷ Rear seat, refer to page 135.

Glove compartment

Front passenger side

Note

 Close the glove compartment again immediately

Close the glove compartment immediately after use while driving; otherwise, injury may occur during accidents. ◀

Opening

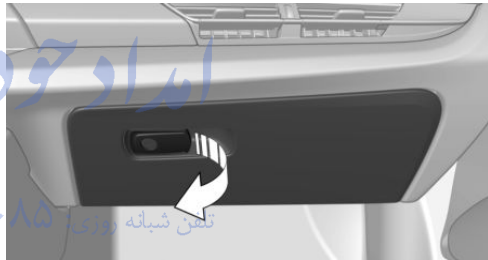

Pull the handle.

Closing

Fold cover closed.

Between the front seats

Center armrest

Open

A storage compartment is located in the center armrest between the seats.

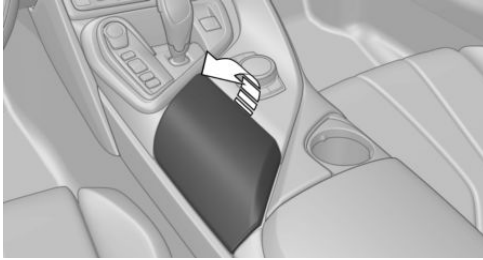

To open, pull upward, arrow.

Front cup holder

Hints

 Shatter-proof containers and no hot drinks

Use light and shatter-proof containers and do not transport hot drinks. Otherwise, there is the increased danger of injury in an accident. ◀

 Unsuitable containers

Do not forcefully push unsuitable containers into the cupholders. This may result in damage. ◀

Overview



Between the seats.

Connection for an external audio device



An external audio device, e.g., an MP3 player, can be connected via the AUX-IN port or the USB audio interface in the center armrest.

Rear seat

Rear cup holder

Hints

 Shatter-proof containers and no hot drinks

Use light and shatter-proof containers and do not transport hot drinks. Otherwise, there is the increased danger of injury in an accident. ◀

 Unsuitable containers

Do not forcefully push unsuitable containers into the cupholders. This may result in damage. ◀

Overview



In the rear of the center console.



امداد خودرو فارما

تلفن خدمات مشتریان: ۰۲۱-۸۸۸۶۲۰۸۵

FarmaSOS.com

Driving tips

This chapter provides you with information useful in dealing with specific driving and operating modes.

امداد خودرو فارما

تلفن شماره اورژانس: ۸۵-۸۸۶۲-۲۱

FarmaSOS.com

Things to remember when driving

Vehicle features and options

This chapter describes all standard, country-specific and optional features offered with the series. It also describes features that are not necessarily available in your car, e. g., due to the selected options or country versions. This also applies to safety-related functions and systems. The respectively applicable country provisions must be observed when using the respective features and systems.

Breaking-in period

General information

Moving parts need time to adjust to one another (break-in time).

The following instructions will help accomplish a long vehicle life and good efficiency.

During break-in, do not use the Launch Control, refer to page 73.

Engine, transmission, and axle drive

Up to 1,200 miles/2,000 km

Do not exceed the maximum engine and road speed:

- ▷ For gasoline engine 4,500 rpm and 100 mph/160 km/h.

Avoid full load or kickdown under all circumstances.

From 1,200 miles/2,000 km

The engine and vehicle speed can gradually be increased.

Tires

Tire traction is not optimal due to manufacturing circumstances when tires are brand-new;

they achieve their full traction potential after a break-in time.

Drive conservatively for the first 200 miles/300 km.

Brake system

Brakes require an initial break-in period of approx. 300 miles/500 km to achieve optimal performance between brake discs and brake pads. Drive moderately during this break-in period.

Following part replacement

The same break-in procedures should be observed if any of the components above-mentioned have to be renewed in the course of the vehicle's operating life.

Using eDRIVE efficiently

The concept

eDRIVE operates automatically. Proactive driving utilizes energy consumption and energy recovery optimally. Energy recovery is used to charge the high-voltage battery. It is important for the supply of electrical components and thus a prerequisite for an extensive range. Energy consumption and recovery depend very much, among other things, on your driving style.

Optimizing driving style

Performance display

The driving style can be optimized using the performance display in ECO PRO mode.



The driving style is efficient as long as the accelerator pedal pointer is within the lower range highlighted in blue during acceleration and deceleration.

The energy recovery occurs during coasting and braking and is displayed in the performance display by the accelerator pedal indicator.

The accelerator pedal pointer is within the CHARGE range.

Efficient energy recovery:

- ▶ The accelerator pedal moves to the left within the blue range of the CHARGE display, arrow 1.
- ▶ The energy use while driving can be optimized by efficient acceleration.

Efficient acceleration:

- ▶ The accelerator pedal moves to the right within the blue range of the eDRIVE display, arrow 2.
- ▶ Use deceleration during coasting as often as possible for energy recovery.

 Brake according to traffic and circumstances

Brake in accordance with the traffic conditions, or there is the risk of accident. ◀

Using drive modes and assistance systems

Max eDRIVE

Max eDRIVE, refer to page 64, forces electric driving. Electric driving is especially efficient

for short distances, low to medium speeds and in stop-and-go traffic.

SAVE battery

SAVE Battery, refer to page 64, conserves the electric range for a later point in time. In this case, the vehicle is driven primarily by the combustion engine.

ECO PRO

ECO PRO, refer to page 145, supports a driving style that saves on fuel consumption. For this purpose, the engine control and comfort features, e. g. the climate control output, are adjusted.

Discharge of the high-voltage battery

Longer idle periods, refer to page 190, can reduce the charging state of the high-voltage battery.



Do not allow the vehicle to sit idle for extended periods with a low charging state

Before storing the vehicle for an extended period, check the battery charge indicator to ensure that the high-voltage battery is fully charged. During the idle period, connect the vehicle to a charging station at a suitable charging location. If necessary, the high-voltage battery will be charged automatically. Make sure that the charging process takes place. Regularly check the charging state. Don't allow battery charge status to drop too low - it will damage the battery. ◀

General driving notes

Closing the tailgate



Drive with the tailgate closed

Only drive with the tailgate closed; otherwise, in the event of an accident or braking and evasive maneuvers, passengers and other traf-

fic may be injured, and the vehicle may be damaged. ◀

If driving with the tailgate open cannot be avoided:

- ▷ Drive moderately.

Hot exhaust system

 Hot exhaust system

High temperatures are generated in the exhaust system.

Do not remove the heat shields installed and never apply undercoating to them. Make sure that flammable materials, e. g. hay, leaves, grass, etc. do not come in contact with the hot exhaust system while driving, while in idle position mode, or when parked. Such contact could lead to a fire, resulting in an increased risk of serious personal injury as well as property damage.

Do not touch hot exhaust pipes; otherwise, there is a danger of getting burned. ◀

Mobile communication devices in the vehicle

 Mobile communication devices in the vehicle

It is not recommended to use mobile phones, such as mobile phones, in the vehicle interior without a direct connection to an external aerial. Otherwise, the vehicle's electronics and mobile communication devices can interfere with each other. In addition, there is no assurance that the radiation generated during transmission will be conducted away from the vehicle interior. ◀

Hydroplaning

 Hydroplaning

When driving on wet or slushy roads, reduce your speed to prevent hydroplaning. ◀

On wet or slushy roads, a wedge of water can form between the tires and road surface.

This phenomenon is referred to as hydroplaning. It is characterized by a partial or complete loss of contact between the tires and the road surface, ultimately undermining your ability to steer and brake the vehicle.

Driving through water

 Observe water level and speed

Do not exceed the maximum water level and maximum speed; otherwise, the vehicle's engine, the electrical systems and the transmission may be damaged. ◀

Drive through calm water only and only if it is not deeper than 9.8 inches/25 cm and at this height, no faster than walking speed, up to 3 mph/5 km/h.

Braking safely

Your vehicle is equipped with ABS as a standard feature.

Applying the brakes fully is the most effective way of braking in situations needed.

Steering is still responsive. You can still avoid any obstacles with a minimum of steering effort.

Pulsation of the brake pedal and sounds from the hydraulic circuits indicate that ABS is in its active mode.

In certain braking situations, the perforated brake discs can cause functional problems. However, this has no effect on the performance and operational reliability of the brake.

Objects within the range of movement of the pedals

 No objects in the area around the pedals

Keep floor mats, carpets, and any other objects out of the pedal area; otherwise, the function of the pedals could be impeded while driving and create the risk of an accident.

Do not place additional floor mats over existing mats or other objects.

Only use floor mats that have been approved for the vehicle and can be properly attached to floor.

Ensure that the floor mats are securely fastened again after they were removed for cleaning, e.g. ◀

Driving in wet conditions

When roads are wet, salted, or in heavy rain, press brake pedal ever so gently every few miles.

Ensure that this action does not endanger other traffic.

The heat generated in this process helps dry the brake discs and pads.

In this way braking efficiency will be available when you need it.

Hills



Avoid stressing the brakes

Avoid placing excessive stress on the brake system. Light but consistent brake pressure can lead to high temperatures, brakes wearing out and possibly even brake failure. ◀



Do not drive in neutral

Do not drive in neutral, in the ECO PRO driving program, or with drive readiness switched off, as doing so disables engine braking. In addition, steering and brake assist are unavailable with the engine stopped. ◀

Drive long or steep downhill gradients in the gear that requires least braking efforts. Otherwise the brakes may overheat and reduce brake efficiency.

You can increase the engine's braking effect by shifting down, going all the way to first gear, if needed.

On downhill sections, use energy recovery if possible to decelerate the vehicle.

Brake disc corrosion

Brake disc corrosion and contamination of the brake pads are favored by:

- ▷ Low mileage.
- ▷ Extended periods when the vehicle is not used at all.
- ▷ Infrequent use of the brakes.

Corrosion will built up when the maximum pressure applied to the brake pads during braking is not reached - thus discs don't get cleaned.

Corrosion buildup on the brake discs will cause a pulsating effect on the brakes in their response - generally that cannot be corrected.

Condensation under the parked vehicle

When using the automatic climate control, condensation water develops collecting underneath the vehicle.

These traces of water under the vehicle are normal.

Loading

Vehicle features and options

This chapter describes all standard, country-specific and optional features offered with the series. It also describes features that are not necessarily available in your car, e. g., due to the selected options or country versions. This also applies to safety-related functions and systems. The respectively applicable country provisions must be observed when using the respective features and systems.

Hints



Overloading the vehicle

To avoid exceeding the approved capacity of the tires, never overload the vehicle. Overloading can lead to overheating and increases the rate at which damage develops inside the tires. This could result in a sudden loss of tire inflation pressure. ◀



No fluids in the cargo area

Make sure that fluids do not leak into the cargo area; otherwise, the vehicle may be damaged. ◀



Heavy and hard objects

Do not stow any heavy and hard objects in the car's interior without securing them; otherwise, they may present a danger to occupants, e.g., during braking and evasive maneuvers. ◀

vehicle and unstable driving situations may result.



2. Determine the combined weight of the driver and passengers that will be riding in your vehicle.
3. Subtract the combined weight of the driver and passengers from XXX kilograms or YYY pounds.
4. The resulting figure equals the available amount of cargo and luggage load capacity.

For example, if the YYY amount equals 1,000 lbs and there will be four 150 lbs passengers in your vehicle, the amount of available cargo and luggage load capacity is 400 lbs: 1,000 lbs minus 600 lbs = 400 lbs.

5. Determine the combined weight of luggage and cargo being loaded on the vehicle. That weight may not safely exceed the available cargo and luggage load capacity calculated in Step 4.

Determining the load limit

1. Locate the following statement on your vehicle's placard:
 - ▶ The combined weight of occupants and cargo should never exceed XXX kg or YYY lbs. Otherwise, damage to the

Load

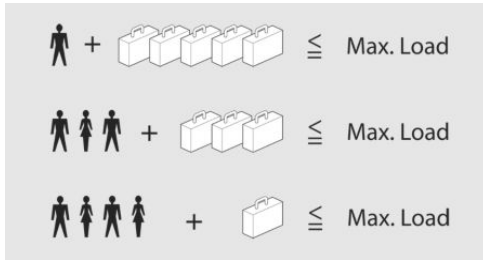

The maximum load is the sum of the weight of the occupants and the cargo.

The greater the weight of the occupants, the less cargo that can be transported.

Stowing cargo

- ▶ Cover sharp edges and corners on the cargo.
- ▶ Heavy cargo: do not exceed the maximum load of the trunk floor. The maximum load capacity is 61 lbs / 28 kg. Stow the cargo as far to the front as possible and below in the trunk.

FarmaSOS.com

Increase range

General information

The vehicle contains comprehensive technologies for reducing the energy consumption and for maximizing the range.

The range depends on a number of different factors.

The implementation of certain measures, driving style and regular maintenance can increase range and thereby also reduce the environmental impact.

Remove unnecessary cargo

Additional weight increases fuel consumption.

Remove attached parts following use

Attached parts on the vehicle impair the aerodynamics and increase the energy consumption.

Closing the windows

Open windows increase air resistance and therefore lead to greater fuel consumption.

Tires

General information

Tires can affect energy consumption in various ways, for instance energy consumption can be influenced by tire size.

Check the tire inflation pressure regularly

Check and, if needed, correct the tire inflation pressure at least twice a month and before starting on a long trip.

Low tire inflation pressure increases rolling resistance and thus raises energy consumption and tire wear.

Standing air conditioning

Run advance climate control, refer to page 127, in the vehicle during charging if possible before driving off.

Heating and cooling operations are very energy intensive and substantially reduce the electric range.

Look well ahead when driving

Avoid unnecessary acceleration and braking.

By maintaining a suitable distance to the vehicle driving ahead of you.

Driving smoothly and proactively reduces fuel consumption.

Longer braking procedures result in more efficient charging of the high-voltage battery via energy recovery from braking.

Use coasting

When approaching a red light, take your foot off the accelerator and let the vehicle coast to a halt.

Switch off any functions that are not currently needed

Functions such as seat heating and the rear window defroster require a lot of energy and reduce the range, especially in city and stop-and-go traffic.

Reel off these functions if they are not needed.

The ECO PRO driving program supports the energy conserving use of comfort features. These functions are automatically deactivated partially or completely.

Have maintenance carried out

Have vehicles maintained regularly to achieve optimal vehicle efficiency and operating life. The maintenance should be carried out by your service center.

Also note the BMW Maintenance System, refer to page 178.

ECO PRO

The concept

ECO PRO supports a driving style that saves on fuel consumption. For this purpose, the engine control and comfort features, e. g. the climate control output, are adjusted.

Under certain conditions the engine is automatically decoupled from the transmission in the D selector lever position and the engine is switched off. Selector lever position D remains engaged.

At a glance

ECO PRO

- ▷ Reduce heat output or heating cycle for exterior mirror, rear window and seat heating.

- ▷ What reduces the the cooling and heating output of the climate control system.

Activate ECO PRO



Press button repeatedly until ECO PRO is displayed in the instrument cluster.

Configuring ECO PRO

Via the Driving Dynamics Control

1. Activate ECO PRO.
2. "Configure ECO PRO"
3. Configure the program.

Via the iDrive

1. "Settings"
 2. "ECO PRO mode"
- Or

1. "Settings"
2. "Driving mode"
3. "Configure ECO PRO"

Configure the program.

- ▷ "Limit at:"

Adjust the ECO PRO speed.

- ▷ "ECO PRO speed warning":

The output is reduced once the set ECO PRO speed is reached.

ECO PRO climate control

"ECO PRO climate control"

Climate control is set to be fuel-efficient.

By making a slight change to the set temperature, or slowly adjusting the rate of heating or cooling of the car's interior, fuel consumption can be economized.

The outputs of the seat heater and the Additionally heat output to seats and exterior mirror is reduced.

The mirror heating is made available when outside temperatures are very cold.

ECO PRO potential

Shows potential savings with the current settings in percentages.

Display in the instrument cluster

Efficiency display



A mark in the performance display informs about the current driving style.

Mark in the CHARGE range, arrow 1: indication for energy recovery and braking.

Mark in the ePOWER area, arrow 2: display when accelerating.

Your driving style's efficiency is shown by the bar's color:

- ▷ Blue display: efficient driving style as long as the mark moves within the blue range.
- ▷ Gray display: adjust driving style, e. g., by reduced acceleration.

The display switches to blue as soon as all conditions for fuel-efficiency-optimized driving are met.

ECO PRO Tip



Driving tip

As soon as one of the conditions for efficient driving is no longer fulfilled, respective driving

instructions are displayed as a symbol in the instrument cluster.

Symbols

An additional symbol and a text message are displayed on the control display.

Symbol	Measure
	For efficient driving back off the accelerator or delay accelerating to allow time to assess road conditions.
	Reduce speed to the selected ECO PRO speed.

Note

The efficiency display and ECO PRO tips in the instrument cluster appear when the ECO PRO display is activated.

Activating driving style and ECO PRO tips:

1. "Settings"
2. "Instrument cluster"
3. "ECO PRO Info"

Indications on the Control Display

eDRIVE

Information on fuel consumption and technology can be displayed while driving.

1. "Vehicle info"
2. "eDRIVE"

Displaying ECO PRO Tips

ECO PRO Tips can be displayed while driving as a note in the split screen in the energy flow display.

Displaying ECO PRO Tips:

1. "Vehicle info"
2. "eDRIVE"
3.  "ECO PRO Tips"

Settings are stored for the profile currently in use.

امداد خودرو فارما

تلفن شبانه روزی: ۰۲۱-۸۸۸۶۲۰۸۵

FarmaSOS.com



امداد خودرو فارما

طابق شبانه روزی: ۰۲۱-۸۸۸۶۲۰۸۵

FarmaSOS.com

Mobility

In order to always ensure your mobility, you will find important information on operating fluids, wheels and tires, maintenance and Roadside Assistance in the following.

امداد خودرو فارما

تلفن شماره روزی: ۰۲۱-۸۸۸۶۲۰۸۵

FarmaSOS.com

Charging vehicle

Vehicle features and options

This chapter describes all standard, country-specific and optional features offered with the series. It also describes features that are not necessarily available in your car, e. g., due to the selected options or country versions. This also applies to safety-related functions and systems. The respectively applicable country provisions must be observed when using the respective features and systems.

The concept

The vehicle can be charged using various charging cables at charging stations or household sockets. Control and monitoring of the charging process are handled completely automatically. The charge current strength can be set by means of the Control Display.

General information

High-voltage battery

The high-voltage battery is used as an energy accumulator. The high-voltage battery can be charged by energy recovery during the trip or via the power grid.

When charging via the power grid, you can choose between the following variants.

- ▷ Level 1 charging via a household socket.
- ▷ Level 2 charging via a Level 2 charging station.

Level 1 charging is possible via a household socket within a voltage range of 100 volts to 240 volts.

For optimal use of the energy from the power grid, charging at a Level 2 charging station, such as BMW i Wallbox, is recommended.

Charge current

The charge current strength is indicated in amperes.

The vehicle cannot automatically detect the maximum permissible charge current strength of the power grid during charging via a household socket or charging station.

Level 1 charging

Prior to the first Level 1 charging at your own household socket, as well as when charging at external electrical power sockets in Level 1, the allowed charge current strength must be determined, e.g. by a qualified electrician.

The charge current strength for Level 1 charging, refer to page 155, can be adjusted in the vehicle in three steps.

At delivery, the charge current for Level 1 charging is set to "Low".

Depending on the country-specific version, one of four ampere ratings is printed on the Level 1 charging cable. This ampere rating is the limit which must be adhered to for the vehicle if the charge current is set to "Maximum". According to the market-specific version, the charge current strength changes differently if the setting "Reduced" or "Low" is selected.

"Maximum"	"Reduced"	"Low"
8 A	6 A	6 A
10 A	7.5 A	6 A
12 A	9 A	6 A
15 A	11.25 A	7.5 A

Depending on the charge current, the charging duration changes.

Maintaining charging state

Should it be necessary, e.g., to conserve the electrical range for a later point in time on the trip, the current charging state of the high-voltage battery can be maintained with Maintaining charging state, refer to page 64.

Hints

Working with electrical current

When working with electrical current, observe the safety regulations. Otherwise, with high voltage or excess current there is a risk to persons and property, e.g., from electrocution or fire. ◀

Have the charging device checked before commissioning

Before the initial charging process, have your own charging device checked at the charging location by a qualified electrician, that is, charging port on the vehicle, charging cable, charging station or household socket and connected circuits. Otherwise, there is a danger of damage to the vehicle and overloading of the supply mains at the charging location. ◀

Follow instructions at the charging station

When working with electrical current, follow the instructions at the charging station. Otherwise, there is a risk of an accident. ◀

Make sure that the charging device is in flawless operating condition

Only use the charging device in a flawless condition. Otherwise, a risk of fire may result, e.g., from the device heating up because of, say, worn contacts or damage. ◀

No simultaneous charging and refueling

Do not refuel while a charging cable is plugged in, and maintain an adequate safety distance from highly flammable materials. Otherwise, there is a danger of personal injury and

property damage from burning fuel vapors, e.g., if the charging cable is improperly plugged in or unplugged. ◀

Have the charging port cleaned by trained personnel

If the charging port is dirty, have the car cleaned only by appropriately trained personnel. Otherwise, there is a danger of injury from high voltage. ◀

Charging cable

General information

Use a Level 1 charging cable, Level 2 charging cable or the permanently installed charging cable of a charging station to charge the vehicle.

Different charging cables can be required depending on the country.

Hints

Use approved charging cables only

Use only approved charging cables or charging stations for charging. Otherwise, there is a danger of property damage or personal injury, e.g., from burning cables. Information about the approved charging cables can be obtained from the service center. ◀

Use the charging cable only for charging the vehicle, and do not extend it

Use the charging cable only for charging the vehicle and do not extend it with cables or adapters. Otherwise, it may not be possible to complete the charging process or property damage might occur, e.g., due to a cable fire. ◀

Do not use any damaged charging cables

Do not use any damaged charging cables. Otherwise, there is a risk of injury from high voltage. ◀

Level 1 charging cable

With the Level 1 charging cable, it is permissible to perform charging from grounded household sockets. At the power connection of a household socket, charging is done with alternating current.

When a Level 1 charging cable is used, this may produce efficiency values other than indicated on the energy label.

Level 2 charging cable

The Level 2 charging cable makes it possible to recharge at sockets of designated Level 2 charging stations using a special plug. Charging is performed with alternating current at designated Level 2 charging stations. The charging process can be completed faster than at household sockets.

If necessary, the charging cable is attached to the charging station.

Storage

The Level 1 charging cable is located in the trunk.

The Level 2 charging cable can be stored in the same place.

If required, store the charging cable with the installed plug cover to prevent moisture in the charging cable plug.

Connection

To connect, engage selector lever in position P and unlock the vehicle. Set the parking brake if needed.

1. Tap on the charging port flap, arrow.



2. Connect either a Level 1 or Level 2 charging cable to the household socket or the port on the charging station.
3. Remove cover of the charging cable plug if needed.
4. Insert the charging cable plug corresponding to the charging port, and push it in until it latches.

When charging at a charging station, follow the instructions at the charging station.

Remove

When the vehicle is locked, the charging cable is locked. Unlock the vehicle before removing the cable.

1. Unlock the vehicle by remote control if it is locked.

Charging cable is unlocked.

2. Press the release button on the handle, arrow 1, and grasp the charging cable at the gripping areas.

Charging process is interrupted.

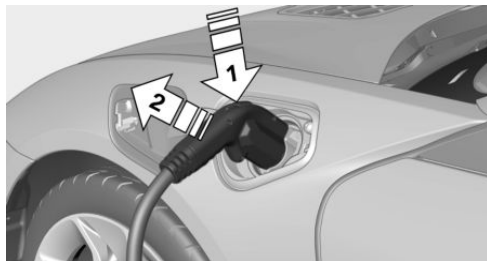

3. Remove the charging cable from the charging port, arrow 2.
4. Close the charging port flap.
5. Attach cover of the charging cable plug if needed.
6. Disconnect either the Level 1 or Level 2 charging cable from the household socket or the port on the charging station as needed.
7. Stow the charging cable.

At a charging station, insert the permanently installed charging cable in the place provided for it.

Manual release

The charging cable may be locked during the charging process if the vehicle is locked.

Manual unlocking of the charging cable

In case of an electrical malfunction, the charging cable can be manually unlocked.

When charging at a charging station, complete the charging process at the charging station before unlocking the charging cable.

1. Open door on the side of the charging port flap.
2. Open cover, arrow 1.

 Pull the blue knob, Arrow 2. Charging cable is manually unlocked.



3. Grasp the charging cable at the gripping areas.
4. Remove charging cable.

Charging operation

Hints

 Following safety instructions of the power mains connection

During the charging process, heed the safety instructions of the respective power mains connection. Otherwise, there could be a risk of personal injury or property damage from high voltage, e.g., from electrocution or fire. ◀

 Using a Level 1 charging cable at other household sockets

Before charging at other household sockets, adapt the charging current strength to the mains. Otherwise, there is a risk of fire, e.g., from overheating of the household socket or overloading of the power mains. ◀

Starting charging process

1. Engage selector lever position P. Set the parking brake if needed.
2. Planning charging process, refer to page 154.
3. Switch off drive readiness.

4. Connect either a Level 1 or Level 2 charging cable to the household socket or the port on the charging station.
5. Open charging port flap.
6. Connect charging cable to the vehicle, refer to page 152.

At high temperatures, initially the high-voltage battery is cooled. The charging process can be started with a delay.

Display of the charging status

The charging status is indicated by the indicator light at the charging port.



- ▷ Lamp white: charging cable can be connected or removed.
- ▷ Lamp flashes yellow: charging process is being initialized
- ▷ Lamp blue: charging process is started at a set time.
- ▷ Lamp flashes blue: charging process active.
- ▷ Lamp flashes red: fault in the charging process.
- ▷ Lamp green: charging process completed.

When the vehicle is locked, the indicator lamp goes out after some time.

When the vehicle is unlocked, the blue indicator lamp flashes continuously. The other indicator lights go out after some time.

To check the charging process, press the  key on the remote control. The charging status is indicated on the indicator lamp. In some cases the vehicle is locked.

Additional messages regarding the charging status, e.g., probable end of charging or the planned departure time, can be displayed in the instrument cluster, on the Control Display and via the BMW i Remote App on the smartphone.

Planning charging process

The charging process can be adapted to constraints, e.g., the cost of electricity. The vehicle can control the charging process in such a way that the charging process is completed at the departure time. A departure time must be set for this purpose, refer to page 156.

The following settings are available:

- ▷ Immediate charging.
- ▷ Set time window for favorable charging.
- ▷ Set charging via a Level 1 charging cable.

If drive readiness is switched off, changes can be made on the Control Display. Departure time can only be changed once. Scheduled departure times are not adjusted. Settings for standing air conditioning and loading process are accepted for planned departure times too.

Immediate charging

The charging process starts as soon as the charging cable is connected.

1. "Settings"
2. "Charging"
3. "Charge immediately"

Setting time window for favorable charging

When departure time is set, a time window for charging with a favorable electricity rate can be set.

1. "Settings"
2. "Charging"
3. "Low cost charging"

4. Set rate begin. Turn the controller until the desired time is set and press the controller.
5. Set rate end. Turn the controller until the desired time is set and press the controller.

Setting charging via a Level 1 charging cable

Depending on the electrical mains, the vehicle must be charged with a different charging current strength, refer to page 150.

1. "Settings"
2. "Charging"
3. "AC charging power:"

Settings are stored. When you change charging locations you also might need to change the setting for charging.

Set the charge current strength at other household sockets to "Low".

Stopping charging process

The charging operation can be stopped at any time by removing the charging cable and continued at a later time by connecting the charging cable in order to use other loads on the power connection or to prevent simultaneous high power from multiple loads.

The charging operation is interrupted when the vehicle is unlocked and automatically resumed after a brief time or when it is locked.

Continue charging operation

If the charging operation is interrupted, e.g., through a temporary power failure, the charging operation is automatically continued after the interruption.

Terminating charging process

1. Removing the charging cable from the vehicle, refer to page 152.
2. Stow the charging cable as required.
3. Close the charging port flap.
4. Lock vehicle if it is unlocked.

Displays in the instrument cluster

The charging state indicator light, refer to page 77, shows the charging state of the high-voltage battery in the instrument cluster, if operating readiness is switched on. If all segments are filled, the high-voltage battery is fully charged.

Even if no segments are filled, the high-voltage system is still under high voltage.

Information regarding the charging process are shown on the charging screen, refer to page 76.

Display Meaning



Blue plug: charging process active or completed.

White plug: charging interruption.



Running light: animated with active charging operation.



End of charging time or set departure time.



Charging progress bar.



Indicator in blue: charged electrical range.



Indicator in white: maximum electrical range.



White clock: departure time set.

Blue plug: charging process active or completed.



White plug: charging interruption.



Climate control activated at departure time.



Flashing: ventilation active.

Display	Meaning
	Flashing: heating active.
	Flashing: cooling active.



Departure time

The concept

For optimum range and climate control, the departure time can be set before parking the car.

With a set departure time, the vehicle is climate controlled during the charging process when climate control is set. Climate control output is reduced during the trip. This increases the range during electric driving.

The following settings are possible at departure time:

- ▷ Climate control at departure time.
- ▷ Planning a one-time departure time.
- ▷ Planning of up to three regular departure times per day of the week.

If drive readiness is switched off, changes can be made on the Control Display. Departure time can only be changed once. Scheduled departure times are not adjusted. Settings for climate control and charging operation are also applied for scheduled departure times.

Climate control at departure time

1. "Settings"
2. "Departure time"
3. "Precond. for departure"

Setting departure time

1. "Settings"
2. "Departure time"
3. "Departure 1:"

4. Set the day of the week if needed.

Turn the controller until the desired day of the week is set and press the controller.

To select other days of the week, repeat the operation.

5. Set the time.

Turn the controller until the desired time is set and press the controller.

Up to three departure times can be set.

Activating the departure time

1. "Settings"
2. "Departure time"
Set departure times are displayed.
3. E. g. "Activate depart. time 1"

Up to three departure times can be activated.

The set departure time will be deactivated, if the departure time was ignored three times in a row.

Climate control

General information

The following settings for climate control of the vehicle are possible:

- ▷ Activate stationary climate control immediately, refer to page 127.
With stationary climate control activated and no charging cable connected, the range is reduced.
- ▷ Planned climate control at the set departure time, refer to page 128.

Discharged high-voltage and vehicle battery

General information

In addition to the high-voltage battery, the vehicle has a 12 volt vehicle battery, which is re-

quired for operation of the onboard electronics.

With a discharged vehicle battery, no operation of the vehicle is possible.

Place vehicle in service

To place the vehicle in service, charge as usual.

If there is no possibility of charging on site, contact the service center.

Charging vehicle with a discharged vehicle battery

1. Unlock the vehicle, if needed, using the integrated key, refer to page 38.
2. Secure the vehicle against rolling.
3. Connect either a Level 1 or Level 2 charging cable to the household socket or the port on the charging station.
4. Attach charging cable corresponding to the charging socket connection.

Charging is started. The charging status is not displayed. Do not open vehicle during this time.

After several minutes, the vehicle is slightly charged. The onboard electronics are ready again. It is again possible to open the vehicle. The charging status as well as the charging state of the high-voltage battery can be displayed again.

If the vehicle battery cannot be charged, contact the service center.

Refueling

Vehicle features and options

This chapter describes all standard, country-specific and optional features offered with the series. It also describes features that are not necessarily available in your car, e. g., due to the selected options or country versions. This also applies to safety-related functions and systems. The respectively applicable country provisions must be observed when using the respective features and systems.

Hints

Observe the fuel recommendation, refer to page 161, prior to refueling.

 Refuel promptly

Refuel no later than at a range of 30 miles/50 km or engine operation might fail and damage might occur. ◀

To also ensure all engine functions under unfavorable conditions, e.g. steep vehicle inclinations, at least 2.6 US gal/10 liters fuel should be refueled.

 Do not refuel unless the engine is at a standstill and the selector lever is in position P/N

Do not refuel unless the engine is at a standstill and the selector lever is in position P/N, otherwise the buildup of pressure may cause the fuel nozzle to shut off prematurely. ◀

Tank vent

The concept

The vehicle is equipped with a special fuel tank. It is designed for special requirements that arise with the hybrid operation of the vehi-

cle, e.g., alternating drive with combustion engine or electric motor.

General information

In the fuel tank, excess pressure can build up due to gasoline vapors which are dissipated before the tank lid is opened.

Overview

The button is located on the driver's side on the door armrest.

Tank venting

1. Switch off drive readiness.

2.  Press button to start the pressure equalization.

The status of the tank venting is displayed in the instrument cluster. In rare cases, the tank venting can last several minutes.

If the tank venting has been completed, a message is displayed in the instrument cluster. The tank lid is released for opening.

3. Open the fuel filler flap.

If the fuel filler flap is not opened within 10 minutes after the fuel filler flap was released, the fuel filler flap relocks. Press button again.

Fuel lid

Opening

Before opening, vent the tank, refer to page 158.

1. Briefly press the rear edge of the fuel filler flap.



2. Turn the tank lid counterclockwise.



3. Place the tank lid in the bracket attached to the fuel filler flap.

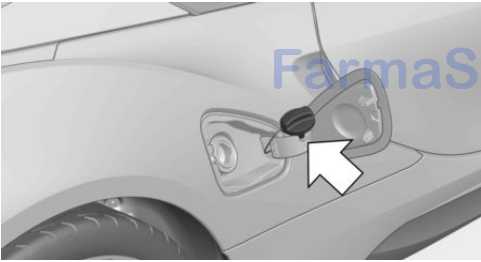

Closing

1. Fit the lid and turn it clockwise until you clearly hear a click.
2. Close the fuel filler flap.



Do not pinch the retaining strap
Do not pinch the retaining strap attached to the lid; otherwise, the lid cannot be closed properly and fuel vapors can escape. ◀

Manually unlocking fuel filler flap

In the event of an electrical malfunction, e.g. The release is located in the trunk.

1. Open the cover on the right side trim.



2. Pull the green knob with the fuel pump symbol. This releases the fuel filler flap.



3. Open the fuel filler flap.
4. Carefully open the fuel filler flap. Excess pressure can build up in the fuel tank from gasoline vapor.

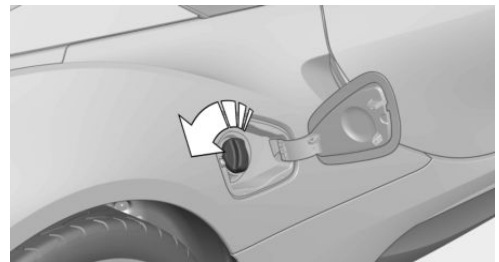

5. Fuel the vehicle as usual. This may be difficult due to the residue pressure in the tank, caused by frequent stopping of the fuel pump nozzle, e.g.

Observe the following when refueling

The fuel tank is full when the filler nozzle clicks off the first time.

 Do not overfill the fuel tank

Do not overfill the fuel tank; otherwise fuel may eslide, causing harm to the environment and damaging the vehicle. ◀

 Handling fuels

Observe safety regulations posted at the gas station. ◀

 No simultaneous charging and refueling

Do not refuel while a charging cable is plugged in, and maintain an adequate safety distance from highly flammable materials. Otherwise, there is a danger of personal injury and property damage from burning fuel vapors, e.g., if the charging cable is improperly plugged in or unplugged. ◀

تلفن شبانه روزی: ۰۲۱-۸۸۸۶۲۰۸۵

FarmaSOS.com

Fuel

Vehicle features and options

This chapter describes all standard, country-specific and optional features offered with the series. It also describes features that are not necessarily available in your car, e. g., due to the selected options or country versions. This also applies to safety-related functions and systems. The respectively applicable country provisions must be observed when using the respective features and systems.

Fuel recommendation

Note



General fuel quality

Even fuels that conform to the specifications can be of low quality. This may cause engine problems, for instance poor engine start-up behavior, poor handling and/or poor performance. Switch gas stations or use a brand name fuel with a higher octane rating. ◀

Gasoline

For the best fuel efficiency, the gasoline should be sulfur-free or very low in sulfur content.

Fuels that are marked on the gas pump as containing metal must not be used.



Refuel only with unleaded gasoline without metallic additives.

Do not refuel with any leaded gasoline or gasoline with metallic additives, e. g. manganese or iron, as this can cause permanent damage to the catalytic converter and other components. ◀

Fuels with a maximum ethanol content of 25 %, i. e. E10 or E25, may be used for refueling.

Ethanol should satisfy the following quality standards:

US: ASTM 4806–xx

CAN: CGSB-3.511–xx

xx: comply with the current standard in each case.



Do not use a fuel with a higher percentage of ethanol

Do not use a fuel with a higher ethanol percentage than recommended or one with other types of alcohol, e.g. M5 to M100; otherwise this could damage the engine and fuel supply system. ◀

Recommended fuel grade

BMW recommends AKI 93.

Minimum fuel grade

BMW recommends AKI 91.



Minimum fuel grade

Do not use any gasoline below the minimum fuel grade as this may impair engine performance. ◀

If you use gasoline with this minimum AKI Rating, the engine may produce knocking sounds when starting at high outside temperatures. This has no effect on the engine life.



Fuel quality

The use of poor-quality fuels may result in harmful engine deposits or damage. Additionally, problems relating to drivability, starting and stalling, especially under certain environmental conditions such as high ambient temperature and high altitude, may occur.

If drivability problems are encountered, we recommend switching to a high quality gasoline brand and a higher octane grade — AKI number — for a few tank fills. To avoid harmful en-

gine deposits, it is highly recommended to purchase gasoline from Top Tier retailers.

Failure to comply with these recommendations may result in the need for unscheduled maintenance.◀

امداد خودرو فارما

تلفن شبانه روزی: ۰۲۱-۸۸۸۶۲۰۸۵

FarmaSOS.com

Wheels and tires

Vehicle features and options

This chapter describes all standard, country-specific and optional features offered with the series. It also describes features that are not necessarily available in your car, e. g., due to the selected options or country versions. This also applies to safety-related functions and systems. The respectively applicable country provisions must be observed when using the respective features and systems.

Tire inflation pressure

Safety information

The tire characteristics and tire inflation pressure influence the following:

- ▷ The service life of the tires.
- ▷ Road safety.
- ▷ Driving comfort.

Checking the tire inflation pressure



Check the tire inflation pressure regularly

Regularly check the tire inflation pressure, and correct it as needed: at least twice a month and before a long trip. If you fail to observe this precaution, you may be driving on tires with incorrect tire pressures, a condition that may not only compromise your vehicle's driving stability, but also lead to tire damage and the risk of an accident. ◀

Tires have a natural, consistent loss of tire inflation pressure.

Tires heat up while driving, and the tire inflation pressure increases along with the tire's temperature. The tire inflation pressure specifications relate to cold tires or tires with the ambient temperature.

Only check the tire inflation pressure when the tires are cold. This means after driving no more than 1.25 miles/2 km or when the vehicle has been parked for at least 2 hours.

The displays of inflation devices may under-read by up to 1.45 psi/0.1 bar.

For Flat Tire Monitor: after correcting the tire inflation pressure, reinitialize the Flat Tire Monitor.

For Tire Pressure Monitor: after correcting the tire inflation pressure, reset the Tire Pressure Monitor.

Tire inflation pressure specifications

The tire inflation pressure table, refer to page 164, contains all tire inflation pressure specifications for the specified tire sizes at the ambient temperature. Tire inflation pressure specifications apply to approved tire sizes and recommended tire brands. This information can be obtained from your service center.

To identify the correct tire inflation pressure, please note the following:

- ▷ Tire sizes of your vehicle.
- ▷ Maximum permitted driving speed.

Tire inflation pressures up to 100 mph/160 km/h

For speeds of up to 100 mph/160 km/h and for optimum driving comfort, note the pressure values in the tire inflation pressure table, refer to page 164, and adjust as necessary.



These pressure values can also be found on the tire inflation pressure label on the driver's door pillar.

! Maximum permissible speed
Do not exceed 100 mph/160 km/h; otherwise, tire damage and accidents may result. ◀

Tire inflation pressure values up to 100 mph/160 km/h

i8

Tire size	Pressure specifications in bar/PSI	
Specifications in bar/PSI with cold tires		
215/45 R 20 95 V M+S XL Std	2.2 / 32	2.2 / 32
F: 195/50 R 20 93 W XL Std	2.2 / 32	-
R: 215/45 R 20 95 W XL Std	-	2.2 / 32
F: 215/45 R 20 95 W XL Std	2.2 / 32	-
R: 245/40 R 20 99 W XL Std	-	2.2 / 32

Tire inflation pressures at max. speeds above 100 mph/160 km/h

! Speeds above 100 mph/160 km/h
In order to drive at maximum speeds in excess of 100 mph/160 km/h, please observe, and, if necessary, adjust tire pressures for speeds exceeding 100 mph/160 km/h from the relevant table on the following pages. Otherwise tire damage and accidents could occur. ◀

Tire inflation pressure values over 100 mph/160 km/h

i8

Tire size	Pressure specifications in bar/PSI	
Specifications in bar/PSI with cold tires		
215/45 R 20 95 V M+S XL Std	2.3 / 33	2.8 / 41
F: 195/50 R 20 93 W XL Std	2.5 / 36	-
R: 215/45 R 20 95 W XL Std	-	3.0 / 44
F: 215/45 R 20 95 W XL Std	2.3 / 33	-
R: 245/40 R 20 99 W XL Std	-	2.8 / 41

Tire identification marks

Tire size

245/45 R 18 96 Y
245: nominal width in mm
45: aspect ratio in %
R: radial tire code

18: rim diameter in inches
 96: load rating, not for ZR tires
 Y: speed rating, before the R on ZR tires

Speed letter

Q = up to 100 mph, 160 km/h
 R = up to 106 mph, 170 km/h
 S = up to 112 mph, 180 km/h
 T = up to 118 mph, 190 km/h
 H = up to 131 mph, 210 km/h
 V = up to 150 mph, 240 km/h
 W = up to 167 mph, 270 km/h
 Y = up to 186 mph, 300 km/h

Tire Identification Number

DOT code: DOT xxxx xxx 0115
 xxxx: manufacturer code for the tire brand
 xxx: tire size and tire design
 0115: tire age
 Tires with DOT codes meet the guidelines of the U.S. Department of Transportation.

Tire age

DOT ... 0115: the tire was manufactured in the 1st week of 2015.

Recommendation

Regardless of wear and tear, replace tires at least every 6 years.

Uniform Tire Quality Grading

Quality grades can be found where applicable on the tire sidewall between tread shoulder and maximum section width.

For example: Treadwear 200; Traction AA; Temperature A

DOT Quality Grades

Treadwear
 Traction AA A B C

Temperature A B C

All passenger car tires must conform to Federal Safety Requirements in addition to these grades.

Treadwear

The treadwear grade is a comparative rating based on the wear rate of the tire when tested under controlled conditions on a specified government test course. For example, a tire graded 150 would wear one and one-half, 1 g, times as well on the government course as a tire graded 100. The relative performance of tires depends upon the actual conditions of their use, however, and may depart significantly from the norm due to variations in driving habits, service practices and differences in road characteristics and climate.

Traction

The traction grades, from highest to lowest, are AA, A, B, and C.

Those grades represent the tire's ability to stop on wet pavement as measured under controlled conditions on specified government test surfaces of asphalt and concrete. A tire marked C may have poor traction performance. The traction grade assigned to this tire is based on straight-ahead braking traction tests, and does not include acceleration, cornering, hydroplaning, or peak traction characteristics.

Temperature

The temperature grades are A, the highest, B, and C, representing the tire's resistance to the generation of heat and its ability to dissipate heat when tested under controlled conditions on a specified indoor laboratory test wheel. Sustained high temperature can cause the material of the tire to degenerate and reduce tire life, and excessive temperature can lead to sudden tire failure. The grade C corresponds to a level of performance which all passenger car tires must meet under the Federal Motor Vehicle Safety Standard No. 109. Grades Band

A represent higher levels of performance on the laboratory test wheel than the minimum required by law.

 Temperature grade for this tire

The temperature grade for this tire is established for a tire that is properly inflated and not overloaded. Excessive speed, underinflation, or excessive loading, either separately or in combination, can cause heat buildup and possible tire failure.

If necessary, have the vehicle towed. ◀

M+S

Winter and all-season tires with better cold weather performance than summer tires.

Tire tread

Summer tires

Do not drive with a tire tread depth of less than 0.12 in/3 mm.

There is an increased danger of hydroplaning if the tire tread depth is less than 0.12 in/3 mm.

Winter tires

Do not drive with a tire tread depth of less than 0.16 in/4 mm.

Below a tread depth of 0.16 in/4 mm, tires are less suitable for winter operation.

Minimum tread depth

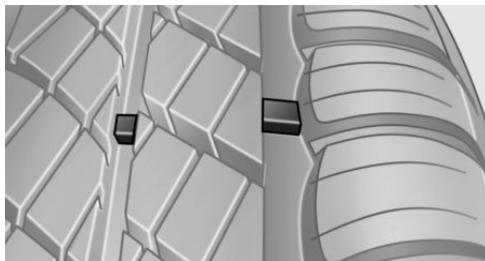

Wear indicators are distributed around the tire's circumference and have the legally required minimum height of 0.063 in/1.6 mm.

They are marked on the side of the tire with TWI, Tread Wear Indicator.

Tire damage

General information

Inspect your tires often for damage, foreign objects lodged in the tread, and tread wear.

Hints

Driving over rough or damaged road surfaces, as well as debris, curbs and other obstacles can cause serious damage to wheels, tires and suspension parts. This is more likely to occur with low-profile tires, which provide less cushioning between the wheel and the road. Be careful to avoid road hazards and reduce your speed, especially if your vehicle is equipped with low-profile tires.

Indications of tire damage or other vehicle defects:

- ▷ Unusual vibrations while driving.
- ▷ Unusual handling such as a strong tendency to pull to the left or right.

Damage can, e. g., be caused by driving over curbs, road damage, or similar things.

**In case of tire damage**

If there are indications of tire damage, reduce your speed immediately and have the rims and tires checked right away; otherwise, there is the increased risk of an accident.

Drive carefully to the nearest service center. If necessary, have the vehicle towed or transported there. Otherwise, tire damage can become life threatening for vehicle occupants and also other traffic. ◀

**Repair of tire damage**

For safety reasons, the manufacturer of your vehicle recommends that you do not have damaged tires repaired; they should be replaced. Otherwise, damage can occur as a result. ◀

Changing wheels and tires

Mounting

**Information on mounting tires**

Have mounting and balancing performed only by a service center.

If work is not carried out properly, there is a danger of subsequent damage and related safety hazards. ◀

Wheel and tire combination

You can ask the service center about the right wheel/tire combination and wheel rim versions for the vehicle.

Incorrect wheel and tire combinations impair the function of a variety of systems such as ABS or DSC.

To maintain good handling and vehicle response, use only tires with a single tread configuration from a single manufacturer.

Following tire damage, have the original wheel and tire combination remounted on the vehicle as soon as possible.

**Approved wheels and tires**

You should only use wheels and tires that have been approved by the vehicle manufacturer for your vehicle type; otherwise, e.g., despite having the same official size ratings, variations can lead to chassis contact and with it, the risk of severe accidents

The manufacturer of your vehicle cannot evaluate non-approved wheels and tires to determine if they are suited for use, and therefore cannot guarantee the operating safety of the vehicle. ◀

Recommended tire brands

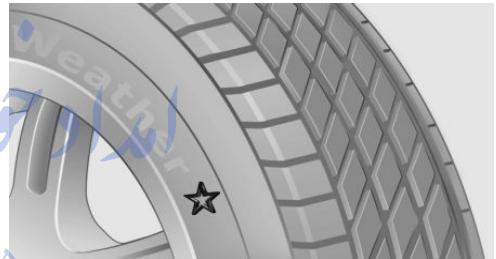

For each tire size, the manufacturer of your vehicle recommends certain tire brands. These can be identified by a star on the tire sidewall. With proper use, these tires meet the highest standards for safety and handling.

New tires

Tire traction is not optimal due to manufacturing circumstances when tires are brand-new; they achieve their full traction potential after a break-in time.

Drive conservatively for the first 200 miles/300 km.

Retreaded tires

The manufacturer of your vehicle does not recommend the use of retreaded tires.

**Retreaded tires**

Possibly substantial variations in the design and age of the tire casing structures can limit service life and have a negative impact on road safety. ◀

Winter tires

Winter tires are recommended for operating on winter roads.

Although so-called all-season M+S tires provide better winter traction than summer tires, they do not provide the same level of performance as winter tires.

Maximum speed of winter tires

If the maximum speed of the vehicle is higher than the permissible speed for the winter tires, then a respective symbol is displayed in your field of vision. You can obtain this sign from the tire specialist or from your service center.

**Maximum speed for winter tires**

Do not exceed the maximum speed for the respective winter tires; otherwise, tire damage and accidents can occur. ◀

Rotating wheels between axles

Different wear patterns can occur on the front and rear axles depending on individual driving conditions. The tires can be rotated between the axles to achieve even wear. Your service center will be glad to advise you. After rotating, check the tire pressure and correct if needed.

Rotating the tires is not permissible on vehicles with different tire sizes or rim sizes on the front and rear axles.

Storage

Store wheels and tires in a cool, dry place with as little exposure to light as possible.

Always protect tires against all contact with oil, grease and fuels.

Do not exceed the maximum tire inflation pressure indicated on the side wall of the tire.

Mobility System**The concept**

With the Mobility System, minor tire damage can be sealed quickly to enable continued travel. To accomplish this, sealant is pumped into the tires, which seals the damage from the inside.

The compressor can be used to check the tire inflation pressure.

Hints

- ▷ Follow the instructions on using the Mobility System found on the compressor and sealant container.
- ▷ Use of the Mobility System may be ineffective if the tire puncture measures approx. 1/8 in/4 mm or more.
- ▷ Contact the nearest service center if the tire cannot be made drivable.
- ▷ If possible, do not remove foreign bodies that have penetrated the tire.
- ▷ Pull the speed limit sticker off the sealant container and apply it to the steering wheel.
- ▷ The use of a sealant can damage the TPM wheel electronics. In this case, have the electronics checked at the next opportunity and have them replaced if needed.

**Enclosed areas**

Do not let the engine run in enclosed areas, since breathing in exhaust fumes may lead to loss of consciousness and death. The exhaust gases contain carbon monoxide, an odorless and colorless but highly toxic gas. ◀

Storage

The Mobility System is located behind the left side trim in the trunk.

Sealing container

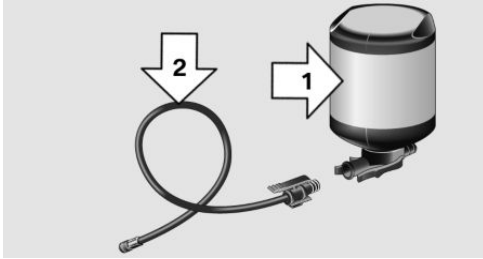

- ▷ Sealing container, arrow 1.
- ▷ Filling hose, arrow 2.

Observe use-by date on the sealant container.

Filling the tire with sealant

1. Shake the sealing container.

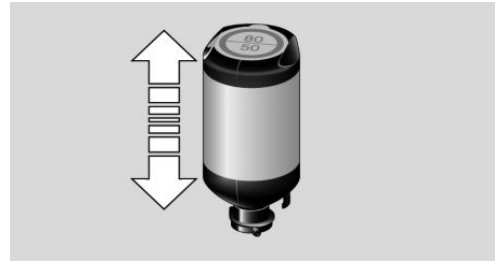

2. Take the connection hose completely out of the compressor housing. Do not kink the hose.

Compressor

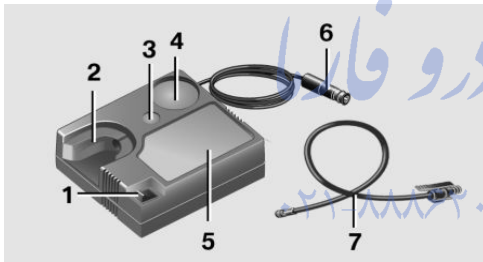

- 1 On/off reel
- 2 Holder for bottle
- 3 Reduce inflation pressure
- 4 Inflation pressure dial
- 5 Compressor
- 6 Connector/cable for socket
- 7 Connection hose — stowed in the bottom of the compressor



3. Attach the connection hose to the connector of the sealing container, ensuring that it engages audibly.

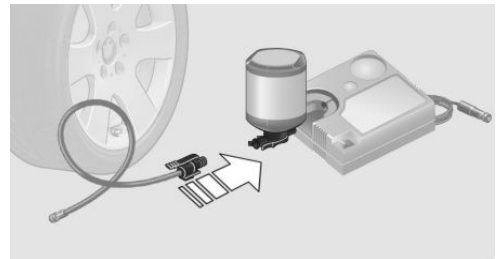

- Slide the sealing container upright into the holder on the compressor housing, ensuring that it engages audibly.

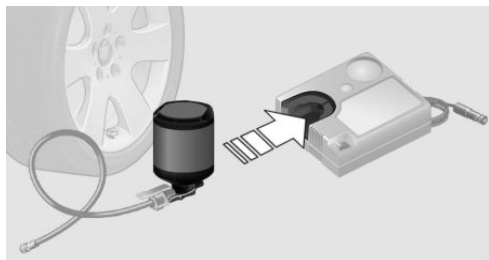

- Screw the connection hose onto the tire valve of the defective wheel.

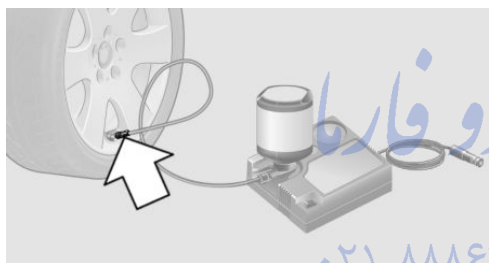

- With the compressor switched off, insert the plug into a power socket inside the vehicle.

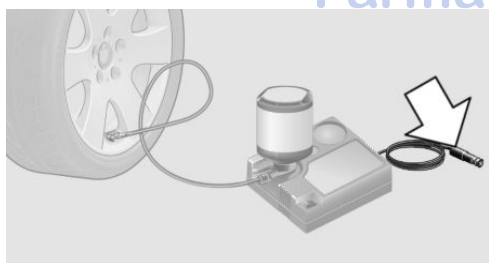

- With operating readiness or drive readiness switched on, reel on the compressor.

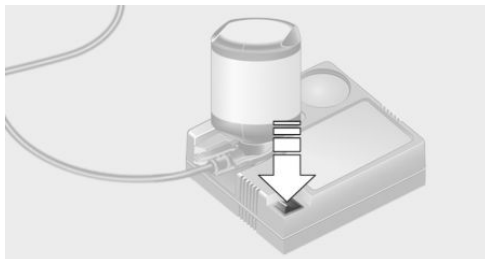

- ⚠** Switch off the compressor after 10 minutes

Do not allow the compressor to run longer than 10 minutes; otherwise, the device will overheat and may be damaged. ◀

Let the compressor run for approx. 3 to 8 minutes to fill the tire with sealant and achieve a tire inflation pressure of approx. 2.5 bar.

While the tire is being filled with sealant, the tire inflation pressure may sporadically reach approx. 5 bar. Do not reel off the compressor at this point. تلفن شبانه ۰۲۱-۸۸۸۶۲۰۰

If a tire inflation pressure of 2 bar is not reached:

- Switch off the compressor.
- Unscrew the filling hose from the wheel.
- Drive 33 ft/10 m forward and back to distribute the sealant in the tire.
- Inflate the tire again using the compressor.

If a tire inflation pressure of 2 bar cannot be reached, contact your service center.

Stowing the Mobility System

- Remove the connection hose of the sealant container from the wheel.
- Remove the connection hose from the sealant container.

3. Wrap the empty sealant container and connection hose in suitable material to avoid dirtying the cargo area.
4. Stow the Mobility System back in the vehicle.

Distributing the sealant

Immediately drive approx. 5 miles/10 km to ensure that the sealant is evenly distributed in the tire.

Do not exceed a speed of 50 mph/80 km/h.

If possible, do not drive at speeds less than 12 mph/20 km/h.

To correct the tire inflation pressure

1. Stop at a suitable location.
2. Screw the connection hose onto the tire valve stem.

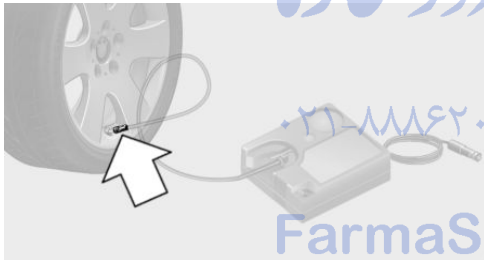

3. Attach the connection hose directly to the compressor.

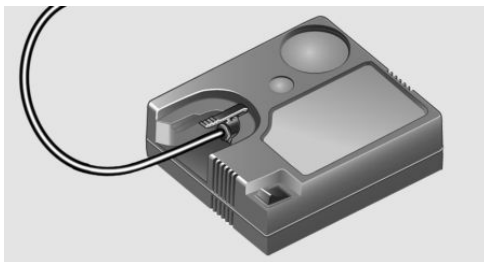

4. Insert the connector into a power socket inside the vehicle.

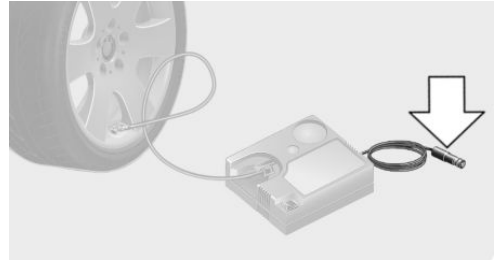

5. Correct the tire inflation pressure to 2.5 bar.
 - ▶ Increase pressure: with operating readiness or drive readiness switched on, reel on the compressor.
 - ▶ To reduce the pressure: press the button on the compressor.

Continuing the trip

Do not exceed the maximum permissible speed of 50 mph/80 km/h.

Reinitialize the Tire Pressure Monitor.

Replace the defective tire and the sealant container of the Mobility System as soon as possible.

Snow chains

Fine-link snow chains

Only certain types of fine-link snow chains have been tested by the manufacturer of the vehicle, classified as road-safe and approved.

Information about the approved snow chains are available from the service center.

Use

Use only in pairs on the rear wheels, equipped with the tires of the following size:

- ▶ 215/45 R 20

Follow the snow chain manufacturer's instructions.

Make sure that the snow chains are always sufficiently tight. Retighten as needed according to the chain manufacturer's instructions.

Do not initialize the Tire Pressure Monitor after mounting snow chains, as doing so may result in incorrect readings.

When driving with snow chains, activate the Sport program with the selector lever. This ensures that the rear wheels are being powered.

When driving with snow chains, briefly activate Dynamic Traction Control if needed.

Maximum speed with snow chains

Do not exceed a speed of 30 mph/50 km/h when using snow chains.

امداد خودرو فارما

تلفن شبانه روزی: ۰۲۱-۸۸۸۶۲۰۸۵

FarmaSOS.com

Engine oil

Vehicle features and options

This chapter describes all standard, country-specific and optional features offered with the series. It also describes features that are not necessarily available in your car, e. g., due to the selected options or country versions. This also applies to safety-related functions and systems. The respectively applicable country provisions must be observed when using the respective features and systems.

General information

The engine oil consumption is dependent on the driving style and driving conditions. When a sporty driving style is used, the engine oil consumption, e.g., is clearly higher.

Therefore, regularly check the engine oil level after refueling.

When a dynamic driving style is used, such as when cornering fast, the system is unable to measure the engine oil level. With this driving style, measure the engine oil level using a detailed measurement, refer to page 173.

The vehicle is equipped with electronic oil measurement.

Electronic oil measurement

Status display

The concept

The engine oil level is monitored electronically while driving and shown on the Control Display.

If the engine oil level reaches the minimum level, a check control message is displayed.

Requirements

A current measured value is available after approx. 30 minutes of driving. During a shorter trip, the status of the last, sufficiently long trip is displayed.

With frequent short-distance trips, regularly perform a detailed measurement.

Displaying the engine oil level

On the Control Display:

1. "Vehicle info"
2. "Vehicle status"
3.  "Engine oil level"

Engine oil level display messages

Different messages appear on the display depending on the engine oil level. Pay attention to these messages.

If the engine oil level is too low, within the next 125 miles/200 km Add engine oil, refer to page 175.



Engine oil level too low

Add engine oil immediately; otherwise, an insufficient amount of engine oil could result in engine damage. ◀

Take care not to add too much engine oil.



Too much engine oil

Have the vehicle checked immediately; otherwise, surplus engine oil can lead to engine damage. ◀

Detailed measurement

The concept

In the detailed measurement the engine oil level is checked and displayed via a scale.

Gasoline engine:

If the engine oil level reaches the minimum level, a check control message is displayed.

Diesel engine:

During the measurement, the idle speed is increased somewhat.

Requirements

- ▷ Vehicle is on level road.
- ▷ Drive readiness is established.
- ▷ Selector lever position N engaged and accelerator pedal not depressed.
- ▷ Engine is running and is at operating temperature.

Performing a detailed measurement

In order to perform a detailed measurement of the engine oil level:

1. "Vehicle info"
2. "Vehicle status"
3.  "Measure engine oil level"
4. "Start measurement"

The engine oil level is checked and displayed via a scale.

Time: approx. 1 minute.

Engine compartment access

The engine compartment is located under the tailgate.

 Working in the engine compartment
Never attempt to perform any service or repair operations on your vehicle without the necessary professional technical training.

If you are unfamiliar with the statutory guidelines, have any work on the vehicle performed only by a service center.

If work is not carried out properly, there is a danger of subsequent damage and related safety hazards. ◀



Never reach into the engine compartment

Never reach into spaces or gaps in the engine compartment; otherwise, there is a risk of injury, e.g., from rotating or hot parts. ◀

Removing covers

1. Turn screws counterclockwise to undo them, arrows 1, and remove cargo cover, arrow 2.

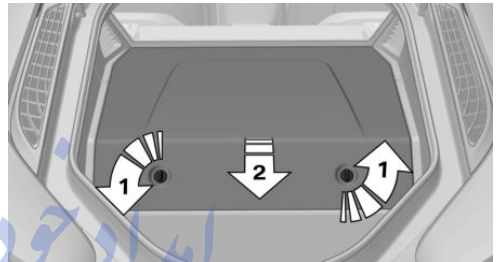

2. Remove insulation.

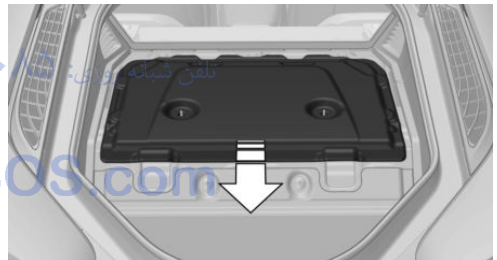

3. Turn screws counterclockwise to undo them and remove engine compartment cover, arrow .

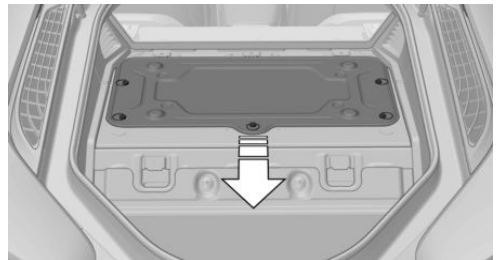

Attaching the covers

1. Insert, arrows 1, press down, arrows 2, and push in, arrow 3 engine compartment cover. Turn screws clockwise to tighten.

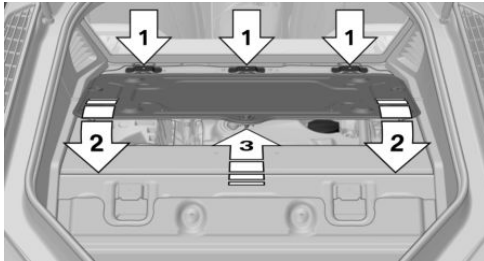



2. Insert insulation.
3. Insert cargo cover, and turn screws clockwise to tighten.

Adding engine oil

General information

Switch off operating readiness and safely park the vehicle before engine oil is added.

Hints

-  Adding engine oil
Add oil within the next 125 miles/200 km; otherwise, this may cause engine damage. ◀
-  Do not add too much engine oil
When too much engine oil is added, immediately have the vehicle checked, otherwise, this may cause engine damage. ◀
-  Protect children
Keep oil, grease, etc., out of reach of children and observe the warnings on the containers to prevent health risks. ◀

Oil filler neck



The oil filler neck is located in the engine compartment. Engine compartment access, refer to page 174.



Only add engine oil when the message is displayed in the instrument cluster. The quantity to be added is indicated in the message displayed in the instrument cluster.

Engine oil types to add

Hints

-  No oil additives
Oil additives may lead to engine damage. ◀
-  Viscosity grades for engine oils
When selecting an engine oil, ensure that the engine oil belongs to one of the viscosity grades SAE 0W-40, SAE 0W-30, SAE 5W-40, and SAE 5W-30 or malfunctions or engine damage may occur. ◀

The engine oil quality is critical for the life of the engine.

Suitable engine oil types

You can add engine oils that meet the following oil rating standards:

Gasoline engine

BMW Longlife-01.

BMW Longlife-01 FE.

Further information regarding the oil specifications and viscosities of engine oils can be acquired with the service center.

Alternative engine oil types

If an engine oil suitable for continuous use is not available, up to 1 US quart/liter of an engine oil with the following oil rating can be added:

Gasoline engine

API SM or superior oil rating.

Engine oil change:

The vehicle manufacturer recommends that you let the service center change the motor oil.

BMW recommends
Original BMW Engine Oil.

امداد خودرو فارما

تلفن شبانه روزی: ۰۲۱-۸۸۸۶۲۰۸۵

FarmaSOS.com

Coolant

Vehicle features and options

This chapter describes all standard, country-specific and optional features offered with the series. It also describes features that are not necessarily available in your car, e. g., due to the selected options or country versions. This also applies to safety-related functions and systems. The respectively applicable country provisions must be observed when using the respective features and systems.

Coolant level

If necessary, have the service center check the coolant level and add coolant as needed.

امداد خودرو فارما

تلفن شبانه روزی: ۰۲۱-۸۸۸۶۲۰۸۵

FarmaSOS.com

Maintenance

Vehicle features and options

This chapter describes all standard, country-specific and optional features offered with the series. It also describes features that are not necessarily available in your car, e. g., due to the selected options or country versions. This also applies to safety-related functions and systems. The respectively applicable country provisions must be observed when using the respective features and systems.

BMW maintenance system

The maintenance system indicates required maintenance measures, and thereby provides support in maintaining road safety and the operational reliability of the vehicle.

In some cases scopes and intervals may vary according to the country-specific version. Replacement work, spare parts, fuels and lubricants and wear materials are calculated separately. Additional information is available from the service center.

Note



Maintenance and repairs

Have maintenance and repair work performed only by a service center or a workshop that works according to BMW specifications with appropriately trained personnel. Otherwise, there is the risk of fatal injury from electrocution due to the high-voltage system's high voltage. ◀

Condition Based Service CBS

Sensors and special algorithms take into account the driving conditions of your vehicle. Based on this, Condition Based Service recognizes the maintenance requirements.

The system makes it possible to adapt the amount of maintenance corresponding to your user profile.

Detailed information on service requirements, refer to page 84, can be displayed on the Control Display.

Service data in the remote control

Information on the required maintenance is continuously stored in the remote control. Your service center will read out this data and suggest the right array of service procedures for your vehicle.

Therefore, hand your service specialist the remote control with which the vehicle was driven most recently.

Storage periods

Storage periods during which the vehicle battery was disconnected are not taken into account.

If this occurs, have a service center update the time-dependent maintenance procedures, such as checking brake fluid and, if needed, changing the engine oil and the microfilter/activated-charcoal filter.

Service and Warranty Information Booklet for US models and Warranty and Service Guide Booklet for Canadian models

Please consult your Service and Warranty Information Booklet for US models and Warranty and Service Guide Booklet for Canadian models for additional information on service requirements.

Maintenance and repair should be performed by your service center. Make sure to have regular maintenance procedures recorded in the vehicle's Service and Warranty Information Booklet for US models, and in the Warranty and Service Guide Booklet for Canadian models. These entries are proof of regular maintenance.

Socket for OBD Onboard Diagnosis

Note



Socket for Onboard Diagnosis

The socket for onboard diagnostics may only be used by the service center or a workshop that operates in accordance with the specifications of the vehicle manufacturer with correspondingly trained personnel and other authorized persons. Otherwise, use may result in operating problems for the vehicle. ◀

Position

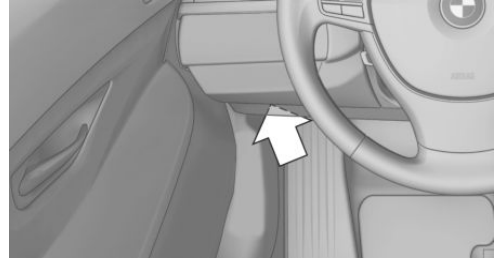

There is an OBD socket on the driver's side for checking the primary components in the vehicle's emissions.

Emissions



▶ The warning lamp lights up: Emissions are deteriorating. Have the vehicle checked as soon as possible.

▶ The warning lamp flashes under certain circumstances:

This indicates that there is excessive misfiring in the engine.

Reduce the vehicle speed and have the system checked immediately; otherwise, serious engine misfiring within a brief period can seriously damage emission control components, in particular the catalytic converter.

Replacing components

Vehicle features and options

This chapter describes all standard, country-specific and optional features offered with the series. It also describes features that are not necessarily available in your car, e. g., due to the selected options or country versions. This also applies to safety-related functions and systems. The respectively applicable country provisions must be observed when using the respective features and systems.

Wiper blade replacement

Hints

 Do not fold down the wipers without wiper blades

Do not fold down the wipers if wiper blades have not been installed; this may damage the windshield. ◀

Replacing the wiper blades

1. To change the wiper blades, fold up, refer to page 70, the wiper arms.
2. Fold up the wipers.

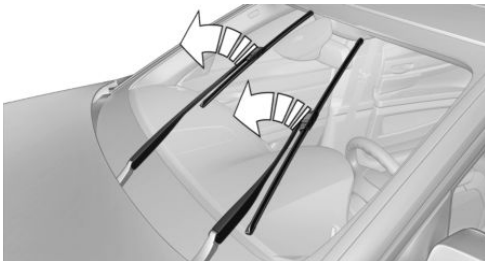

3. Position the wiper blade in a horizontal position.

4. Remove the wiper blade toward one side.



5. Insert the new wiper blade in reverse order of removal until it locks in place.
6. Fold down the wipers.

Lamp and bulb replacement

General information

All headlights and lights are made using LED or laser technology. Contact your service center in the event of a malfunction.

Headlight glass

Condensation can form on the inside of the external lights in cool or humid weather. When driving with the light switched on, the condensation evaporates after a short time. The headlight glass does not need to be changed.

If the headlights do not dim despite driving with the light switched on, increasing humidity forms, e. g. water droplets in the light, have the service center check this.

Light-emitting diodes (LEDs)

Some items of equipment use light-emitting diodes installed behind a cover as a light source.

These light-emitting diodes, which are related to conventional lasers, are officially designated as Class 1 light-emitting diodes.

Hints

 Do not perform any work on the lighting system

Have any work on the lighting system, including bulb replacement, performed only by a service center. Due to the high voltage present in the system, there is a danger of fatal injuries if work is carried out improperly. ◀

 Irritation of the retina
Never look directly into the headlights or their light sources for a lengthy period of time, otherwise this could irritate your retinas. ◀

 Do not remove the covers
Do not remove the covers, and never stare into the unfiltered light for several hours; otherwise, irritation of the retina could result. ◀

Changing wheels

Hints

When sealants are used, an immediate wheel change when there is a loss of tire inflation pressure in the event of a flat tire is unnecessary.

Which is why no spare tire is available.

The tools for changing wheels are available as accessories from your service center.

Jacking points for the vehicle jack

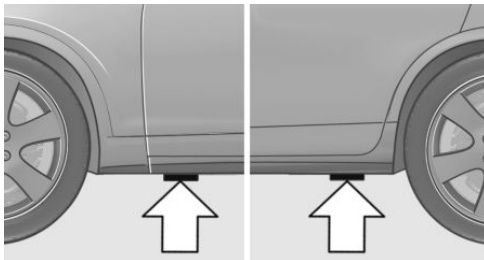

The jacking points for the vehicle jack are located at the positions shown.

Vehicle battery

The vehicle battery has 12 volts. The battery supplies the onboard electronics with energy. Information about the high-voltage system, refer to page 150.

Maintenance

The battery is maintenance-free.

The added amount of acid is sufficient for the service life of the battery.

Further information about the battery can be obtained from your service center.

Battery replacement

 Use approved vehicle batteries only
Only use vehicle batteries that have been approved for your vehicle by the manufacturer; otherwise, the vehicle could be damaged and systems or functions may not be fully available. ◀

After a battery replacement, have the battery registered on the vehicle by the service center to ensure that all comfort features are fully available and that any Check Control messages of these comfort features are no longer displayed.

Charge vehicle battery

 Do not use any charging devices
Do not charge the vehicle battery with an external charging device; otherwise, there is a risk of property damage, e. g., to the vehicle's electronics. ◀

Charging a discharged battery, refer to page 156.

Power failure

After a temporary power loss, some equipment needs to be newly initialized or individual settings updated, e. g.:

▷ Time: update.

- ▷ Date: update.

Disposing of old batteries



Have old batteries disposed of by your service center or bring them to a recycling center.

Maintain the battery in an upright position for transport and storage. Secure the battery so that it does not tip over during transport.

Fuses

Hints



Replacing fuses

Never attempt to repair a blown fuse and do not replace a defective fuse with a substitute of another color or amperage rating; this could lead to a circuit overload, ultimately resulting in a fire in the vehicle. ◀

Replacing fuse

The fuses are located in the passenger footwell under the dashboard.

1. To open, loosen screws, arrow 1.

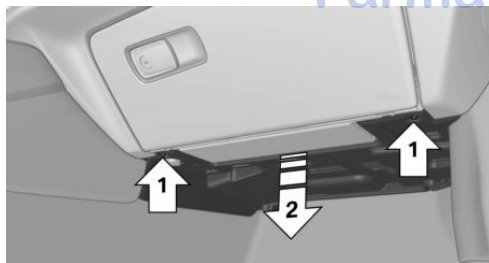

2. Remove cover, arrow 2.

Information on the fuse types and locations is found on a separate sheet.

3. Replace the fuse in question.
4. The installation is done in reverse order from the removal.

Breakdown assistance

Vehicle features and options

This chapter describes all standard, country-specific and optional features offered with the series. It also describes features that are not necessarily available in your car, e. g., due to the selected options or country versions. This also applies to safety-related functions and systems. The respectively applicable country provisions must be observed when using the respective features and systems.

Hazard warning flashers



The button is located in the center console.

Intelligent Emergency Request

The concept

In case of an emergency, an Emergency Request can be made through this system.

General information

Only press the SOS button in an emergency.

Hints



Emergency Request not guaranteed

For technical reasons, the Emergency Request cannot be guaranteed under unfavorable conditions. ◀

Overview



SOS button in the roofliner

Requirements

- ▷ The SIM card integrated in the vehicle has been activated.
- ▷ The radio-ready state is switched on.
- ▷ The Assist system is functional.

Initiating an Emergency Request

1. Press the cover briefly to open it.
2. Press the SOS button until the LED at the button lights up green.
 - ▷ The LED lights up green: an Emergency Request was initiated.

If a cancel prompt appears on the display, the Emergency Request can be aborted.

If the situation allows, wait in your vehicle until the voice connection has been established.
- ▷ The LED flashes green when a connection to the BMW Response Center has been established.

When the emergency request is received at the BMW Response Center, the BMW Response Center contacts you and takes further steps to help you.

Even if you are unable to respond, the BMW Response Center can take further steps to help you under certain circumstances.

For this, data are transmitted to the BMW Response Center which serve to determine the necessary rescue measures. E. g. the current position of the vehicle, if it can be established.

- ▶ If the LED is flashing green, but the BMW Response Center can no longer be heard via the speaker, you can nevertheless still be heard at the BMW Response Center.

Initiating an Emergency Request automatically

Under certain conditions, an Emergency Request is automatically initiated immediately after a severe accident. Automatic Collision Notification is not affected by pressing the SOS button.

Warning triangle

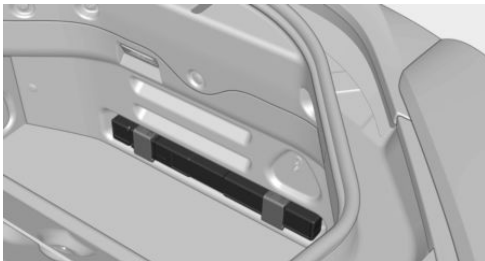

The warning triangle is located in the bottom of the trunk.

Release the Velcro® fastener to remove it.

First aid kit

Note

Some of the articles have a limited service life.

Check the expiration dates of the contents regularly and replace any expired items promptly.

Storage

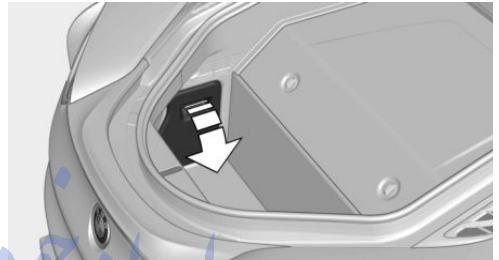

The first aid kit is located in the trunk, behind the folding cover on the left side.

Jump-starting



Not jumping or directly charging the vehicle battery

Do not jump or directly charge the vehicle battery using conventional jump starting; otherwise, because of the high voltage of the drive system, there is a danger of fatal injury from electrocution. ◀

If the high-voltage battery and the vehicle battery are discharged, it is not possible to operate the vehicle. In this case, do not give a jump start, but instead charge the battery as usual using the charging cable, refer to page 156.

Tow-starting and towing

Transporting your vehicle

Note

Your vehicle is not permitted to be towed. Therefore, contact a service center in the event of a breakdown.

! Do not have the vehicle towed. Have your vehicle transported on a loading platform only; otherwise, damage may occur. ◀

Tow truck

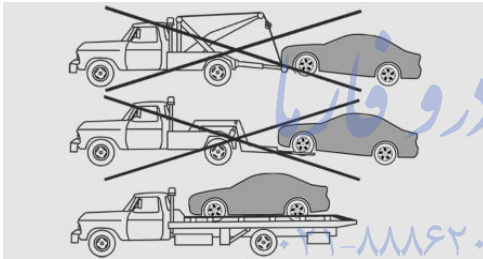

The vehicle should only be transported on a loading platform.

! Do not lift the vehicle. Do not lift the vehicle by the tow fitting or body and chassis parts; otherwise, damage may result. ◀

Use tow fitting located in the front only for positioning the vehicle.

Pushing vehicle

To remove a disabled vehicle from the danger area, push it for a short distance at a speed of no more than 6 mph/10 km/h.

The vehicle can only be pushed in selector lever position N.

In order to ensure that the vehicle can roll, proceed as follows:

1. Switch on drive readiness, refer to page 61.
2. Depress brake pedal.
3. Engage selector lever position N.

If there are electrical malfunctions, it may happen that you can't change the selector lever position.

Towing other vehicles

The tow-starting or towing of other vehicles with the BMW i8 is not possible.

Tow fitting

The screw-in tow fitting should always be carried in the vehicle.

The tow fitting can be screwed in at the front of your BMW.

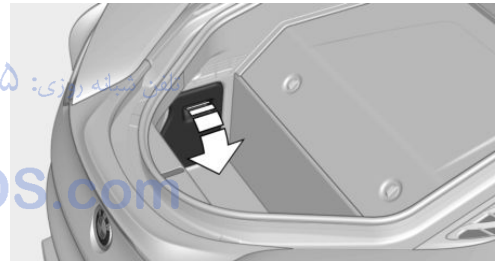

The tow fitting is located under the first aid kit behind the left folding cover in the trunk.

- !** Tow fitting, information on use
- ▶ Use only the tow fitting provided with the vehicle and screw it all the way in.
 - ▶ Use the tow fitting for towing on paved roads only.
 - ▶ Use tow fitting located in the front only for positioning the vehicle.
 - ▶ Avoid lateral loading of the tow fitting, e.g., do not lift the vehicle by the tow fitting.

Otherwise, damage to the tow fitting and the vehicle can occur. ◀

Screw thread for tow fitting

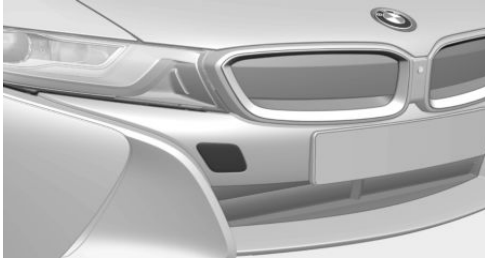

Press on the mark on the edge of the cover to push it out.

- ▷ Secure the crash site.
- ▷ Immediately notify rescue forces, police, or firefighters of the fact that your vehicle is equipped with a high-voltage system.
- ▷ Engage selector lever position P, apply the parking brake, and reel off the ignition or deactivate drive readiness.
- ▷ Lock the vehicle after exiting.
- ▷ Do not inhale any gases esiding from the high-voltage battery; if needed, maintain a safe distance from the vehicle.

Tow-starting

Steptronic transmission

Do not tow-start the vehicle.

Tow-starting the engine is not possible due to the Steptronic transmission.

Have the cause of the starting problems fixed.

What to do after an accident

Hints



After an accident

After an accident, do not touch any high-voltage components such as orange colored high-voltage cables or parts that are in contact with exposed high-voltage cables. Otherwise, there is the risk of fatal injury from electrocution due to the system's high voltage. ◀



Esiding fluids

Do not touch any fluids esiding from the high-voltage battery, or the skin can sustain chemical burns. ◀

General information

If you are involved in an accident with your vehicle, compliance with the following additional safety precautions is required with regard to the high-voltage system:

Care

Vehicle features and options

This chapter describes all standard, country-specific and optional features offered with the series. It also describes features that are not necessarily available in your car, e. g., due to the selected options or country versions. This also applies to safety-related functions and systems. The respectively applicable country provisions must be observed when using the respective features and systems.

Car washes

General information

Regularly remove foreign objects, e.g. leaves, from the air outlet grills in the hood.

Wash your vehicle frequently, particularly in winter. Intense soiling and road salt can damage the vehicle.

Hints

 Closing the charging port flap
Close the charging port flap while washing the vehicle. Otherwise, the vehicle could be damaged. ◀

 Steam jets or high-pressure washers
When using steam jets or high-pressure washers, hold them a sufficient distance away and use a maximum temperature of 140 °F/60 °C.

Ensure that a distance of at least 31.5 inches/80 cm from the charging port flap is maintained. Holding them too close or using excessively high pressures or temperatures can cause damage or preliminary damage that may then lead to long-term damage.

Follow the user's manual for the high-pressure washer. ◀

 Cleaning sensors/camera lenses with high-pressure washers

When using high-pressure washers, do not spray the sensors and camera lenses on the outside of the vehicle for long periods and maintain a distance of at least 12 in/30 cm. ◀

 Have the charging port cleaned by trained personnel

If the charging port is dirty, have the car cleaned only by appropriately trained personnel. Otherwise, there is a danger of injury from high voltage. ◀

Automatic car washes

Hints

- ▶ Give preference to cloth car washes or those that use soft brushes in order to avoid paint damage.
- ▶ Make sure that the wheels and tires are not damaged by the transport mechanisms.
- ▶ Fold in the exterior mirrors; otherwise, they may be damaged, depending on the width of the vehicle.
- ▶ Deactivate the rain sensor, refer to page 69, to avoid unintentional wiper activation.
- ▶ In some cases, an unintentional alarm can be triggered by the interior motion sensor of the alarm system. Follow the instructions on avoiding an unintentional alarm, refer to page 48.

 Guide rails in car washes
Avoid car washes with guide rails higher than 4 in/10 cm; otherwise, the vehicle body could be damaged. ◀

Before driving into a car wash

In order to ensure that the vehicle can roll in a car wash, take the following steps:

1. Drive into the car wash.
2. Engage selector lever position N.
3. Press the Start/Stop button.

In this way, operating readiness remains switched on, and a Check-Control message is displayed.

To activate drive readiness:

1. Depress the brake pedal.
2. Press the Start/Stop button.

Pressing the Start/Stop button without stepping on the brake turns operating readiness off.

Selector lever position

Selector lever position P is engaged automatically:

- ▷ With operating readiness turned off.
- ▷ After approx. 15 minutes.

Headlights

- ▷ Do not rub dry and do not use abrasive or acidic cleansers.
- ▷ Soak areas that have been dirtied e. g., from insects, with shampoo and wash off with water.
- ▷ Thaw ice with de-icing spray; do not use an ice scraper.

After washing the vehicle

After washing the vehicle, apply the brakes briefly to dry them; otherwise, braking action can be reduced and corrosion of the brake discs can occur.

Completely remove all residues on the windows, to minimize loss of visibility due to smearing and to reduce wiper noises and wiper blade wear.

Vehicle care

Car care products

BMW recommends using care and cleaning products from BMW, since these have been tested and approved.



Car care and cleaning products

Follow the instructions on the container.

When cleaning the interior, open the doors or windows.

Only use products intended for cleaning vehicles.

Cleansers can contain substances that are dangerous and harmful to your health. ◀

Vehicle paint

Regular care contributes to driving safety and value retention. Environmental influences in areas with elevated air pollution or natural contaminants, such as tree resin or pollen can affect the vehicle's paintwork. Tailor the frequency and extent of your car care to these influences.

Aggressive substances such as spilled fuel, oil, grease or bird droppings, must be removed immediately to prevent the finish from being altered or discolored.

Leather care

Remove dust from the leather often, using a cloth or vacuum cleaner.

Otherwise, particles of dust and road grime chafe in pores and folds, and lead to increased wear and premature degradation of the leather surface.

To guard against discoloration, such as from clothing, provide leather care roughly every two months.

Clean light-colored leather more frequently because soiling on such surfaces is substantially more visible.

Use leather care products; otherwise, dirt and grease will gradually break down the protective layer of the leather surface.

Suitable care products are available from the service center.

Upholstery material care

Vacuum regularly with a vacuum cleaner.

If upholstery is very dirty, e.g., with beverage stains, use a soft sponge or microfiber cloth with a suitable interior cleaner.

Clean the upholstery down to the seams using large sweeping motions. Avoid rubbing the material vigorously.



Damage from Velcro® fasteners

Open Velcro® fasteners on pants or other articles of clothing can damage the seat covers. Ensure that any Velcro® fasteners are closed. ◀

Caring for special components

Light-alloy wheels

When cleaning the vehicle, use only neutral wheel cleaners having a pH value from 5 to 9. Do not use abrasive cleaning agents or steam jets above 140 °F/60 °C. Follow the manufacturer's instructions.

Aggressive, acidic or alkaline cleaning agents can destroy the protective layer of adjacent components, such as the brake disk.

Chrome surfaces

Carefully clean components such as the radiator grille or door handles with an ample supply of water, possibly with shampoo added, particularly when they have been exposed to road salt.

Rubber components

Aside from water, treat only with rubber cleansers.

When cleaning rubber seals, do not use any silicon-containing car care products in order to avoid damage or noises.

Plastic components

These include:

- ▷ Imitation leather surfaces.
- ▷ Roofliner.
- ▷ Lamp lenses.
- ▷ Instrument cluster cover.
- ▷ Matt black spray-coated components.
- ▷ Painted parts in the interior.
- ▷ Carbon parts in the interior.

Clean with a microfiber cloth.

Dampen cloth lightly with water.

Do not soak the roofliner.



No cleansers that contain alcohol or solvents

Do not use cleansers that contain alcohol or solvents, such as lacquer thinners, heavy-duty grease removers, fuel, or such; this could lead to surface damage. ◀

Safety belts

Dirty belt straps impede the reeling action and thus have a negative impact on safety.



Chemical cleaning

Do not clean chemically; this can destroy the webbing. ◀

Use only a mild soapy solution, with the safety belts clipped into their buckles.

Do not allow the reels to retract the safety belts until they are dry.

Carpets and floor mats



No objects in the area around the pedals

Keep floor mats, carpets, and any other objects out of the pedal area; otherwise, the function of the pedals could be impeded while driving and create the risk of an accident.

Do not place additional floor mats over existing mats or other objects.

Only use floor mats that have been approved for the vehicle and can be properly attached to floor.

Ensure that the floor mats are securely fastened again after they were removed for cleaning, e.g. ◀

Floor mats can be removed from the car's interior for cleaning.

If the floor carpets are very dirty, clean with a microfiber cloth and water or a textile cleaner. To prevent matting of the carpet, rub back and forth in the direction of travel only.

Sensor/camera lenses

To clean sensors and camera lenses, use a cloth moistened with a small amount of glass detergent.

Displays/monitors

 Cleaning displays and screens
Do not use any chemical or household cleaning agents; otherwise, surfaces can be affected. ◀

 Keeping out moisture
Keep all fluids and moisture away from the unit; otherwise, electrical components can be damaged. ◀

 Avoid pressure
Avoid pressing too hard when cleaning and do not use abrasive materials; otherwise, damage can result. ◀

Clean with a clean, antistatic microfiber cloth.

Long idle times and long-term vehicle storage

 Do not allow the vehicle to sit idle for extended periods with a low charging state
Before storing the vehicle for an extended period, check the battery charge indicator to en-

sure that the high-voltage battery is fully charged. For longer idle times, park the vehicle with a charging plug plugged into a suitable power source. Regularly check charging state. Otherwise, the high-voltage battery can be damaged when there is excessive discharge. ◀

For idle phases that last several weeks, park the vehicle with a fully charged battery if possible.

Do not park the vehicle for longer than 14 days if the electric range is less than 6 mls, approx. 10 km.

With storage times of up to three months, if possible plug the vehicle into a suitable power source or park it in a nearly fully charged state.

Note

The service center can advise you on what to consider when storing the vehicle for longer than three months.

FarmaSOS.com

امداد خودرو فارما

تلفن شبانه روزی: ۰۲۱-۸۸۸۶۲۰۸۵

FarmaSOS.com



امداد خودرو فارما

شماره تلفن شبانه روزی: ۰۲۱-۸۸۸۶۲۰۸۵

FarmaSOS.com

Reference

This chapter contains the technical data and an index that will quickly take you to the information you need.

امداد خودرو فارما

تلفن شبانه روزی: ۰۲۱-۸۸۸۶۲۰۸۵

FarmaSOS.com

Technical data

Vehicle features and options

This chapter describes all standard, country-specific and optional features offered with the series. It also describes features that are not necessarily available in your car, e. g., due to

the selected options or country versions. This also applies to safety-related functions and systems. The respectively applicable country provisions must be observed when using the respective features and systems.

Note

The technical data and specifications in this Owner's Manual are used as guidance values. The vehicle-specific data can deviate from this, for example, due to the selected special equipment, country version or country-specific measurement method. Detailed values can be

found in the approval documents, on information signs on the vehicle or can be obtained from the service center.

The information in the vehicle documents always has priority.

Dimensions

The dimensions can vary depending on the model version, equipment or country-specific measurement method.

The specified heights do not take into account attached parts, for example, a roof antenna,

roof racks or spoiler. The heights can deviate, for example, due to the selected special equipment, tires, load and chassis version.

BMW i8

Width with mirrors	inches/mm	87.3/2,218
Width without mirrors	inches/mm	76.5/1,942
Height	inches/mm	50.8/1,291
Length	inches/mm	184.9/4,697
Wheelbase	inches/mm	110.2/2,800
Smallest turning radius diam.	ft/m	40.4/12.3

Weights

BMW i8		
Approved gross vehicle weight	lbs/kg	4,090/1,855
Load	lbs/kg	620/281
Approved front axle load	lbs/kg	1,975/896
Approved rear axle load	lbs/kg	2,195/996
Cargo area capacity	cu ft/l	4.7/154

Capacities

	US gal/liters
Fuel tank, approx.	11.1/42

تلفن شبانه روزی: ۰۲۱-۸۸۸۶۲۰۸۵

FarmaSOS.com

Appendix

Any updates to the Owner's Handbook for Vehicle are listed here.

امداد خودرو فارما

تلفن شبانه روزی: ۰۲۱-۸۸۸۶۲۰۸۵

FarmaSOS.com

امداد خودرو فارما

تلفن شبانه روزی: ۰۲۱-۸۸۸۶۲۰۸۵

FarmaSOS.com

Everything from A to Z

Index

A

- ABS, Antilock Brake System [109](#)
- Acceleration Assistant, refer to Launch Control [73](#)
- Accessories and parts [7](#)
- Acoustic pedestrian protection [65](#)
- AC quick charging cable, see Level 2 charging cable [152](#)
- Activated-charcoal filter [127](#)
- Activate drive readiness [63](#)
- Adapting to the course of the road, hybrid system [79](#)
- Adaptive brake lights, refer to Brake force display [108](#)
- Additives, oil [175](#)
- Adjustments, seats/head restraints [51](#)
- Adjustments, steering wheel [56](#)
- Advance climate control, refer to Stationary climate control [127](#)
- After washing vehicle [188](#)
- Airbags [96](#)
- Airbags, indicator/warning light [97](#)
- Air circulation, refer to Recirculated-air mode [125](#)
- Air, dehumidifying, refer to Cooling function [125](#)
- Air distribution, manual [126](#)
- Air flow, automatic climate control [126](#)
- Air pressure, tires [163](#)
- Air vents, refer to Ventilation [127](#)
- Alarm system [47](#)
- Alarm, unintentional [48](#)
- All around the center console [16](#)
- All around the roofliner [17](#)
- All around the steering wheel [14](#)
- All-season tires, refer to Winter tires [168](#)
- Alternating-code hand-held transmitter [130](#)
- Alternative oil types [176](#)
- Ambient light [95](#)
- Antifreeze, washer fluid [70](#)
- Antilock Brake System, ABS [109](#)
- Anti-slip control, refer to DSC [109](#)
- Approved axle load [195](#)
- Approved engine oils, see Suitable engine oil types [175](#)
- Arrival time [88](#)
- Artificial engine noise [65](#)
- Assistance for the combustion engine [65](#)
- Assistance when driving off [112](#)
- ASSIST, Hybrid system [65](#)
- Assist system, refer to Intelligent Safety [102](#)
- AUTO intensity [126](#)
- Automatic car wash [187](#)
- Automatic climate control [124](#)
- Automatic Curb Monitor [54](#)
- Automatic deactivation, front-seat passenger airbags [98](#)
- Automatic deactivation of the high-voltage system [34](#)
- Automatic headlight control [93](#)
- Automatic locking [47](#)
- Automatic recirculated-air control [125](#)
- Automatic transmission, see Steptronic Sport transmission [70](#)
- AUTO program, automatic climate control [126](#)
- AUTO program, intensity [126](#)
- Average fuel consumption [87](#)
- Average speed [88](#)
- Axle loads, weights [195](#)

B

- Backup charging [156](#)
- Band-aids, refer to First aid kit [184](#)
- Battery, 12 volt [181](#)
- Battery replacement, vehicle battery [181](#)
- Battery replacement, vehicle remote control [39](#)
- Battery state indicator [77](#)
- Battery, vehicle [181](#)
- Belts, safety belts [53](#)
- BMW Assist [6](#)
- BMW eDRIVE [31](#)
- BMW Homepage [6](#)
- BMW i Driver's Guide App [6](#)
- BMW Internet page [6](#)
- BMW maintenance system [178](#)
- Body work, see Working on the vehicle [34](#)
- Brake assistant [109](#)
- Brake discs, break-in [138](#)
- Brake force display [108](#)
- Brake lights, adaptive [108](#)
- Brake lights, brake force display [108](#)
- Brake pads, break-in [138](#)

Braking, hints **140**
 Breakdown assistance **183**
 Break-in **138**
 Brightness of Control Display **90**
 Bulb replacement **180**
 Bulbs and lamps **180**
 Button, Start/Stop **61**
 Bypassing, refer to Jump-starting **184**

C

California Proposition 65 Warning **8**
 Camera lenses, care **190**
 Camera, rearview camera **118**
 Camera, Side View **122**
 Camera, Top View **121**
 Car battery **181**
 Car care products **188**
 Care, displays **190**
 Care, vehicle **188**
 Cargo **142**
 Cargo area **132**
 Cargo cover **132**
 Car key, refer to Remote control **38**
 Carpet, care **189**
 Car wash **187**
 Catalytic converter, refer to Hot exhaust system **140**
 CBS Condition Based Service **178**
 Center armrest **134**
 Center console **16**
 Central locking system **44**
 Central screen, refer to Control Display **18**
 Changes, technical, refer to Safety **7**
 Changing wheels **181**
 Changing wheels/tires **167**
 CHARGE, energy recovery **66**
 Charging battery, see Vehicle charging **150**
 Charging, refer to Charging vehicle **150**
 Charging, refer to Vehicle charging **150**
 Charging screen **76**
 Charging state indicator, high-voltage battery **77**
 Charging status, see display of the charging status **154**
 Charging vehicle **150**
 Charging vehicle, refer to Vehicle charging **150**
 Chassis number, see vehicle identification number **10**
 Check Control **79**
 Checking the engine oil level electronically **173**
 Checking the oil level electronically **173**
 Children, seating position **57**
 Children, transporting safely **57**
 Child restraint fixing system **57**
 Child restraint fixing system LATCH **58**
 Child restraint fixing systems, mounting **57**
 Child seat, mounting **57**
 Child seats **57**
 Chrome parts, care **189**
 Cleaning displays **190**
 Climate control **124**
 Clock **83**
 Closing/opening via door lock **43**
 Closing/opening with remote control **41**
 Combination reel, refer to Turn signals **67**
 Combination switch, refer to Wiper system **68**
 Combustion engine, starting **63**
 Comfort Access **45**
 COMFORT program, Dynamic Driving Control **111**
 Compressor **168**
 Computer, refer to On-board computer **87**
 Condensation on windows **127**
 Condensation under the vehicle **141**
 Condition Based Service CBS **178**
 Confirmation signal **47**
 ConnectedDrive **6**
 ConnectedDrive Services **6**
 Connecting electrical devices **131**
 Contact with water, high-voltage system **34**
 Control Display **18**
 Control Display, settings **89**
 Controller **18**
 Control systems, driving stability **109**
 Convenient opening with the remote control **42**
 Coolant **177**
 Coolant temperature **83**
 Cooling function **125**
 Cooling, maximum **125**
 Cooling system **177**
 Corrosion on brake discs **141**
 Cosmetic mirror **131**
 Courtesy lamps during unlocking **41**
 Courtesy lamps with the vehicle locked **42**
 Cruise control **113**
 Cruising range **83**
 Current fuel consumption **87**

D

Damage, tires **166**
 Data, technical **194**
 Date **83**

- Daytime running lights [93](#)
- Deactivating drive readiness [63](#)
- Defrosting, refer to Windows, defrosting [127](#)
- Dehumidifying, air [125](#)
- Deleting personal data [24](#)
- Deletion of personal data [24](#)
- Departure times, stationary climate control [128](#)
- Destination distance [88](#)
- Digital clock [83](#)
- Dimensions [194](#)
- Dimmable exterior mirrors [55](#)
- Dimmable interior rearview mirror [55](#)
- Direction indicator, refer to Turn signals [67](#)
- Display in windshield [90](#)
- Display lighting, refer to Instrument lighting [95](#)
- Displays [75](#)
- Displays, cleaning [190](#)
- Displays, hybrid system [77](#)
- Disposal, vehicle battery [182](#)
- Distance control, refer to PDC [115](#)
- Distance to destination [88](#)
- Divided screen view, split screen [13](#)
- Door lock [43](#)
- Door lock, refer to Remote control [38](#)
- Drive-off assistant [112](#)
- Drive-off assistant, refer to DSC [109](#)
- Driver's door, LED [41](#)
- Drive readiness [61](#)
- Drive readiness in detail [62](#)
- Drive readiness, deactivate [63](#)
- Driving Dynamics Control [111](#)
- Driving instructions, break-in [138](#)
- Driving instructions, eDRIVE drive system [138](#)
- Driving mode [111](#)
- Driving notes, general [139](#)
- Driving stability control systems [109](#)
- Driving tips [139](#)
- Driving with combustion engine, POWER [65](#)
- DSC Dynamic Stability Control [109](#)
- DTC Dynamic Traction Control [110](#)
- Dynamic Stability Control DSC [109](#)
- Dynamic Traction Control DTC [110](#)
- E**
- eBOOST [65](#)
- ECO PRO [145](#)
- ECO PRO display [145](#)
- ECO PRO driving mode [145](#)
- ECO PRO mode [145](#)
- ECO PRO Tip - driving instruction [146](#)
- eDRIVE drive system, driving instructions [138](#)
- eDRIVE, electric driving, see BMW eDRIVE [32](#)
- eDrive system, at a glance [31](#)
- EfficientDynamics [146](#)
- Electric drive readiness, Silent Start [63](#)
- Electric driving, ePOWER [64](#)
- Electric driving, max eDRIVE [64](#)
- Electric driving, see BMW eDRIVE [32](#)
- Electronic oil measurement [173](#)
- Electronic Stability Program ESP, refer to DSC [109](#)
- Emergency charging, refer to Backup charging [156](#)
- Emergency detection, remote control [39](#)
- Emergency release, fuel filler flap [159](#)
- Emergency Request [183](#)
- Emergency start function, engine start [39](#)
- Emergency unlocking, tailgate [45](#)
- Emergency unlocking, transmission lock [73](#)
- Energy Control [87](#)
- Energy recovery, CHARGE [66](#)
- Engine coolant [177](#)
- Engine noise, artificial [65](#)
- Engine oil [173](#)
- Engine oil, adding [175](#)
- Engine oil additives [175](#)
- Engine oil change [176](#)
- Engine oil filler neck [175](#)
- Engine oil temperature [83](#)
- Engine oil types, alternative [176](#)
- Engine oil types, approved [175](#)
- Engine start during malfunction [39](#)
- Engine start, jump-starting [184](#)
- Engine temperature [83](#)
- Entering a car wash [187](#)
- ePOWER, electric driving [64](#)
- Equipment, interior [129](#)
- Error displays, see Check Control [79](#)
- ESP Electronic Stability Program, refer to DSC [109](#)
- Exchanging wheels/tires [167](#)
- Exhaust system [140](#)
- Exterior mirror, automatic dimming feature [55](#)
- Exterior mirrors [54](#)
- External start [184](#)
- External temperature display [83](#)

External temperature warning 83

F

Failure message, see Check Control 79

False alarm, refer to Unintentional alarm 48

Fan, refer to Air flow 126

Filler neck for engine oil 175

First aid kit 184

Fitting for towing, see Tow fitting 185

Flat tire, changing wheels 181

Flat tire, Tire Pressure Monitor TPM 99

Flat tire, warning lamp 100

Flooding 140

Floor carpet, care 189

Floor mats, care 189

Fold-out position, wiper 70

Foot brake 140

Front airbags 96

Front armrest 134

Front beverage holder, front cup holder 135

Front bottle holder, refer to Front cup holder 135

Front can holder, refer to Front cup holder 135

Front cup holder 135

Front-end collision warning with City Braking function 103

Front holder for beverages 135

front-seat passenger airbags, automatic deactivation 98

Front-seat passenger airbags, indicator lamp 98

Fuel 161

Fuel consumption, current 87

Fuel consumption, refer to Average fuel consumption 87

Fuel filler flap 158

Fuel gauge 82

Fuel lid 158

Fuel quality 161

Fuel recommendation 161

Fuel, tank capacity 195

Fuse 182

G

Garage door opener, refer to Universal Integrated Remote Control 129

Gasoline 161

Gear change, Steptronic Sport transmission 71

Gear shift indicator 85

Gearshift, see Steptronic Sport transmission 70

General driving notes 139

Glare shield 131

Glove compartment 134

GPS location, vehicle position 90

Gross vehicle weight, approved 195

Gross vehicle weight, approved 195

H

Handbrake, refer to parking brake 66

Hand-held transmitter, alternating code 130

Hazard warning flashers 183

Head airbags 96

Headlight control, automatic 93

Headlight courtesy delay feature 92

Headlight courtesy delay feature, remote control 47

Headlight courtesy delay feature via remote control 42

Headlight flasher 68

Headlight glass 180

Headlights, care 188

Head restraints 51

Head restraints, front 54

Head-up Display 90

Head-up Display, care 190

Heavy cargo, stowing 143

Height, vehicle 194

High-beam Assistant 94

High beams 68

High beams/low beams, refer to High-beam Assistant 94

High-voltage battery, charging state indicator 77

High-voltage battery, discharge 139

High-voltage system, automatic deactivation 34

High-voltage system, contact with water 34

High-voltage system, safety 34

Hills 141

Hill start assistant, refer to Drive-off assistant 112

Hints 6

Homepage 6

Hood 44

Horn 14

Hot exhaust system 140

HUD Head-up Display 90

Hybrid system, adapting to the course of the road 79

Hybrid system, displays 77

Hydroplaning 140

I

Ice warning, see External temperature warning 83

Icy roads, see External temperature warning 83

Identification marks, tires 164

Identification number, see vehicle identification number **10**

iDrive **18**

Ignition key, refer to Remote control **38**

Increase range **144**

Indication of a flat tire **100**

Indicator and alarm lamps, see Check Control **79**

Indicator lamp, see Check Control **79**

Individual air distribution **126**

Individual settings, refer to Personal Profile **39**

Inflation pressure, tires **163**

Info display, refer to On-Board computer **87**

Initialize, Tire Pressure Monitor TPM **100**

Instrument cluster **75**

Instrument lighting **95**

Integrated key **38**

Integrated Owner's Manual in the vehicle **29**

Intelligent Emergency Request **183**

Intelligent Safety **102**

Intensity, AUTO program **126**

Interior equipment **129**

Interior lights **95**

Interior lights during unlocking **41**

Interior lights with the vehicle locked **42**

Interior motion sensor **48**

Interior rearview mirror, automatic dimming feature **55**

Interior rearview mirror, manually dimmable **55**

Internet page **6**

Interval display, service requirements **84**

Interval mode **69**

J

Jacking points for the vehicle jack **181**

Joystick, Steptronic Sport transmission **71**

Jump-starting **184**

Jump starting, refer to Backup charging **156**

K

Key/remote control **38**

Keyless Go, refer to Comfort Access **45**

Key Memory, refer to Personal Profile **39**

Kickdown, Steptronic Sport transmission **71**

Knee airbag **97**

L

Lamp replacement, see Bulb replacement **180**

Language on Control Display **90**

LATCH child restraint system **58**

Launch Control **73**

Leather, care **188**

LED in the driver's door **41**

LEDs, light-emitting diodes **180**

Length, vehicle **194**

Letters and numbers, entering **24**

Level 1 Charging **155**

Level 1 charging cable **152**

Level 2 charging cable **152**

Light alloy wheels, care **189**

Light-emitting diodes, LEDs **180**

Lighting **92**

Lights **92**

Light switch **92**

Load **143**

Loading **142**

Lock, door **43**

Locking/unlocking via door lock **43**

Locking/unlocking with remote control **41**

Locking, automatic **47**

Locking, settings **46**

Locking via tailgate **45**

Longer idle phases **190**

Long idle times and long-term vehicle storage **190**

Long-term vehicle storage **190**

Low beams **92**

Low beams, automatic, refer to High-beam Assistant **94**

M

Maintaining charging state **64**

Maintenance **178**

Maintenance requirements **178**

Maintenance, service requirements **84**

Maintenance system, BMW **178**

Make-up mirror **131**

Malfunction displays, see Check Control **79**

Manual air distribution **126**

Manual air flow **126**

Manual mode, transmission **72**

Manual operation, door lock **43**

Manual operation, exterior mirrors **54**

Manual operation, fuel filler flap **159**

Manual operation, Park Distance Control PDC **116**

Manual operation, rearview camera **118**
 Manual operation, Top View **121**
 Marking on approved tires **167**
 Master key, refer to Remote control **38**
 Max eDRIVE, electric driving **64**
 Maximum cooling **125**
 Maximum speed, display **85**
 Maximum speed, winter tires **168**
 Measure, units of **90**
 Medical kit **184**
 Menu, EfficientDynamics **146**
 Menu in instrument cluster **86**
 Menus, operating, iDrive **18**
 Menus, refer to iDrive operating concept **19**
 Messages, see Check Control **79**
 Microfilter **127**
 Minimum tread, tires **166**
 Mirrors **54**
 Mobile communication devices in the vehicle **140**
 Mobility System **168**
 Modifications, technical, refer to Safety **7**
 Moisture in headlight **180**
 Monitor, refer to Control Display **18**
 Mounting of child restraint systems **57**
 Multifunction steering wheel, buttons **14**
 Multimedia **6**

N

Navigation **6**
 Neck restraints, front, refer to Head restraints **54**

Neutral cleaner, see wheel cleaner **189**
 New wheels and tires **167**

O

OBD Onboard Diagnosis **179**
 OBD, see OBD Onboard Diagnosis **179**
 Obstacle marking, rearview camera **119**
 Octane rating, refer to Recommended fuel grade **161**
 Odometer **83**
 Office **6**
 Oil **173**
 Oil, adding **175**
 Oil additives **175**
 Oil change **176**
 Oil change interval, service requirements **84**
 Oil filler neck **175**
 Oil types, alternative **176**
 Oil types, approved **175**
 Old batteries, disposal **182**
 On-board computer **87**
 Onboard monitor, refer to Control Display **18**
 Opening/closing via door lock **43**
 Opening and closing **38**
 Opening and closing, without remote control **43**
 Opening and closing, with remote control **41**
 Operating concept, iDrive **18**
 Operating readiness **61**
 Operating readiness off **62**
 Operating readiness on **61**
 Optional equipment, standard equipment **6**
 Outside air, refer to Automatic recirculated-air control **125**
 Overheating of engine, refer to Coolant temperature **83**

P

Paint, vehicle **188**
 Park Distance Control PDC **115**
 Parked car ventilation, refer to Stationary climate control **127**
 Parked vehicle, condensation **141**
 Parking aid, refer to PDC **115**
 Parking brake **66**
 Parking lights **92**
 Parts and accessories **7**
 Passenger side mirror, tilting downward **54**
 Pathway lines, rearview camera **119**
 PDC Park Distance Control **115**
 Pedestrian protection **65**
 Pedestrian warning with city braking function **105**
 Performance Control **111**
 Personal Profile **39**
 Personal Profile, exporting profiles **40**
 Pinch protection system, windows **49**
 Plastic, care **189**
 POWER, driving with combustion engine **65**
 Power failure **181**
 Power windows **49**
 Pressure, tire air pressure **163**
 Profile, refer to Personal Profile **39**
 Programmable memory buttons, iDrive **23**
 Protective function, windows **49**
 Push-and-turn switch, refer to Controller **18**

Q

Quick charging cable, see
Level 2 charging cable [152](#)

R

Radiator fluid [177](#)

Radio [6](#)

Radio-operated key, refer to
Remote control [38](#)

Radio ready state [61](#)

Rain sensor [69](#)

Rear beverage holder, rear
cup holder [135](#)

Rear bottle holder, refer to
Rear cup holder [135](#)

Rear can holder, refer to Rear
Cup holder [135](#)

Rear cup holder [135](#)

Rear holder for beverages [135](#)

Rearview camera [117](#)

Rearview mirror [54](#)

Rear window defroster [127](#)

Recirculated-air filter [127](#)

Recirculated-air mode [125](#)

Recommended fuel
grade [161](#)

Recommended tire
brands [167](#)

Refueling [158](#)

Remaining range [83](#)

Remote control/key [38](#)

Remote control, malfunction [43](#)

Remote control, universal [129](#)

Replacement fuse [182](#)

Replacing wheels/tires [167](#)

Reporting safety defects [10](#)

RES button, see Cruise control [113](#)

Reserve warning, refer to
Range [83](#)

Reset, Tire Pressure Monitor
TPM [100](#)

Retreaded tires [167](#)

Roadside parking lights [93](#)

RON recommended fuel
grade [161](#)

Roofliner [17](#)

Rubber components,
care [189](#)

S

Safe braking [140](#)

Safety [7](#)

Safety belt reminder for driver's
seat and front passenger seat [53](#)

Safety belts [53](#)

Safety belts, care [189](#)

Safety of the high-voltage
system [34](#)

Safety systems, airbags [96](#)

SAVE Battery, maintaining
charging state [64](#)

Screen, refer to Control Display [18](#)

Screw thread, see screw
thread for tow fitting, screw
thread for tow fitting [186](#)

Sealant [168](#)

Seat belts, refer to Safety
belts [53](#)

Seat heating, front [52](#)

Seating position for children [57](#)

Seats [51](#)

Selection list in instrument
cluster [86](#)

Selector lever, Steptronic
Sport transmission [71](#)

Sensors, care [190](#)

Service and warranty [8](#)

Service requirements, Condition
Based Service
CBS [178](#)

Service requirements, display [84](#)

Services, ConnectedDrive [6](#)

SET button, see Cruise control [113](#)

Settings, locking/unlocking [46](#)

Settings, mirrors [54](#)

Settings on Control Display [89](#)

Shift paddles on the steering
wheel [73](#)

Side airbags [96](#)

Side View [122](#)

Signaling, horn [14](#)

Signals when unlocking [47](#)

Silent Start, electric drive
readiness [63](#)

Sitting safely [51](#)

Size [194](#)

Smallest turning radius [194](#)

Snow chains [171](#)

Socket [131](#)

Socket, OBD Onboard Diagnostics [179](#)

SOS button [183](#)

Spare fuse [182](#)

Specified engine oil
types [175](#)

Speed, average [88](#)

Speed limit detection, on-board
computer [88](#)

Speed limiter, display [85](#)

Speed Limit Information [85](#)

Speed warning [88](#)

Split screen [23](#)

Sport program, transmission [72](#)

Stability control systems [109](#)

Standard charging cable, see
Level 1 charging cable [152](#)

Standard charging, see Level
1 Charging [155](#)

Standing air conditioning, remote
control [47](#)

Start/Stop button [61](#)

Start function during malfunction **39**
 Starting the combustion engine **63**
 Stationary climate control **127**
 Status control display, tires **100**
 Status information, iDrive **22**
 Status of Owner's Manual **7**
 Steering wheel, adjusting **56**
 Steptronic Sport transmission **70**
 Storage compartments **134**
 Storage compartments, locations **134**
 Storage, tires **168**
 Storing the vehicle **190**
 Suitable engine oils **175**
 Summer tires, tread **166**
 Sun visor **131**
 Supplementary text message **82**
 Surround View **117**
 Switch for Dynamic Driving **111**
 Switch, refer to Cockpit **14**
 Symbols **6**
 Symbols in the status field **22**
 SYNC program, automatic climate control **125**

T

Tachometer **82**
 Tailgate closing **45**
 Tailgate, emergency unlocking **45**
 Tailgate opening **44**
 Tailgate via remote control **42**
 Tail lamps, see Bulb replacement **180**
 Tank unlocking, refer to Tank vent **158**
 Tank vent **158**

Technical changes, refer to Safety **7**
 Technical data **194**
 Telephone **6**
 Temperature, automatic climate control **125**
 Temperature display for external temperature **83**
 Temperature, engine oil **83**
 Text message, supplementary **82**
 Theft alarm system, refer to Alarm system **47**
 Tilt alarm sensor **48**
 Time of arrival **88**
 Tire damage **166**
 Tire identification marks **164**
 Tire inflation pressure **163**
 Tire Pressure Monitor TPM **99**
 Tires, changing **167**
 Tire sealant **168**
 Tires, everything on wheels and tires **163**
 Tire tread **166**
 Tone **6**
 Top View **120**
 Total range **83**
 Total vehicle weight **195**
 Touchpad **21**
 Tow fitting **185**
 Towing **185**
 Tow lug, see Tow fitting **185**
 Tow-starting **185**
 TPM Tire Pressure Monitor **99**
 Traction control **110**
 TRACTION, driving dynamics **110**
 Transmission lock, electronic unlocking **73**
 Transmission, see Steptronic Sport transmission **70**
 Transporting children safely **57**
 Tread, tires **166**

Trip computer **88**
 Triple turn signal activation **68**
 Trip odometer **83**
 Turning circle lines, rearview camera **119**
 Turning radius **194**
 Turn signals, operation **67**

U

Unintentional alarm **48**
 Units of measure **90**
 Universal remote control **129**
 Unlock button, Steptronic Sport transmission **71**
 Unlocking/locking via door lock **43**
 Unlocking/locking with remote control **41**
 Unlocking, settings **46**
 Updates made after the editorial deadline **7**
 Upholstery care **189**
 USB interface **132**

V

Vanity mirror **131**
 Variable light distribution **93**
 Vehicle battery **181**
 Vehicle battery, replacing **181**
 Vehicle, break-in **138**
 Vehicle care **188**
 Vehicle features and options **6**
 Vehicle identification number **10**
 Vehicle jack **181**
 Vehicle paint **188**
 Vehicle position, GPS location **90**
 Vehicle wash **187**
 Ventilation **127**

Venting, refer to Stationary climate control [127](#)
 VIN, see vehicle identification number [10](#)
 Voice activation system [26](#)

W

Warning and indicator lamps, see Check Control [79](#)
 Warning displays, see Check Control [79](#)
 Warning messages, see Check Control [79](#)
 Warning triangle [184](#)
 Warranty [7](#)
 Washer fluid [70](#)
 Washer nozzles, windshield [69](#)
 Washer system [68](#)
 Washing, vehicle [187](#)
 Water, high-voltage system [34](#)
 Water on roads [140](#)
 Weights [195](#)
 Welcome lamps during unlocking [41](#)
 Welcome lights [92](#)
 What to do after an accident [186](#)
 Wheelbase, vehicle [194](#)
 Wheel cleaner [189](#)
 Wheels, changing [167](#)
 Wheels, everything on wheels and tires [163](#)
 Wheels, Tire Pressure Monitor TPM [99](#)
 Width, vehicle [194](#)
 Window defroster, rear [127](#)
 Windows, powered [49](#)
 Windshield washer fluid [70](#)
 Windshield washer nozzles [69](#)
 Windshield washer system [68](#)
 Windshield wiper [68](#)

Winter storage, care [190](#)
 Winter tires, suitable tires [168](#)
 Winter tires, tread [166](#)
 Wiper [68](#)
 Wiper blades, replacing [180](#)
 Wiper fluid [70](#)
 Wiper, fold-out position [70](#)
 Wiper system [68](#)
 Word match concept, navigation [25](#)
 Working on the body, see Working on the vehicle [34](#)
 Working on the high-voltage system, see Working on the vehicle [34](#)

امداد خودرو فارما

تلفن شبانه روزی: ۰۲۱-۸۸۸۶۲۰۸۵

FarmaSOS.com

امداد خودرو فارما

تلفن شبانه روزی: ۰۲۱-۸۸۸۶۲۰۸۵

FarmaSOS.com

امداد خودرو فارما

تلفن شبانه روزی: ۰۲۱-۸۸۸۶۲۰۸۵

FarmaSOS.com

01 40 2 960 891 ue

